

1.888.610.7664



www.calcert.com

sales@calcert.com

Notes

Write down the name and information of your OAKTON distributor here.

OPERATING INSTRUCTIONS

OAKTON® 35632-Series

Portable Waterproof pH/Dissolved Oxygen Meter

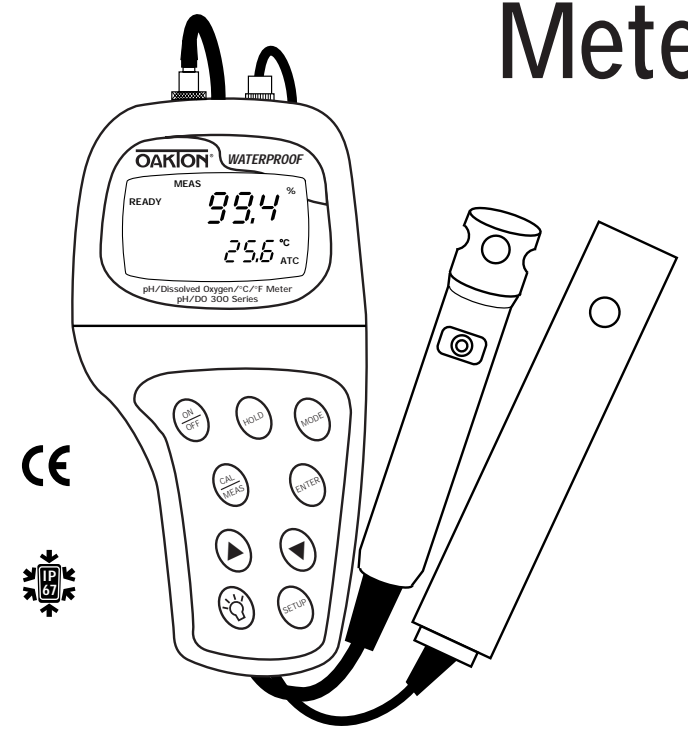

OAKTON®

OAKTON®



Table of Contents

1. Introduction	4	8.5 pH mode—Program P4.0: Resetting to factory default settings.....	38
2. Display and keypad functions	5-6	8.6 % saturation mode—Program P1.0: Dissolved oxygen parameters	
2.1 Display	5	Pressure adjustment mode	39
2.2 Keypad	6	8.7 % saturation mode—Program P2.0: Offset adjustment.....	40
3. Preparation	7-9	8.8 % saturation mode—Program P3.0: Previous calibration information.....	41
3.1 Inserting the batteries	7	8.9 % saturation mode—Program P4.0: Electrode properties	42
3.2 Probe information — Connecting the probes.....	8-9	8.10 % saturation mode—Program P5.0: Unit configuration.....	43-44
4. Calibration	10-19	P5.1 READY indicator and auto endpoint function.....	43
4.1 Important information on meter calibration	10	P5.2 Selecting °C or °F temperature readout.....	44
4.2 Preparing the meter for pH calibration	11	8.11 % saturation mode—Program P6.0: Adjusting LCD brightness	45
4.3 pH calibration.....	12-13	8.12 % saturation mode—Program P7.0: Resetting to factory default.....	46
4.4 Preparing the meter for DO calibration.....	14	8.13 mg/l (ppm) mode—Program P1.0: Dissolved oxygen parameters	47-48
4.5 Dissolved oxygen calibration in % saturation.....	15-16	P1.1 Pressure adjustment mode	47
4.6 Dissolved oxygen calibration in mg/l (ppm) mode	17-18	P1.2 Salinity adjustment mode.....	48
4.7 Temperature calibration	19	8.14 mg/l (ppm) mode—Program P2.0: Previous calibration information.....	49
5. Measurement	20-24	8.15 mg/l (ppm) mode—Program P3.0: Electrode properties	50
5.1 Taking DO readings.....	20-21	8.16 mg/l (ppm) mode—Program P4.0: Unit configuration.....	51-53
5.2 Taking pressure/salinity compensated DO measurements	21-22	P4.1 READY indicator and auto endpoint function.....	51
5.3 Taking pH readings.....	23-24	P4.2 Selecting mg/l or ppm units.....	52
5.4 Manual temperature compensation	25	P4.3 Selecting °C or °F temperature readout.....	53
6. Hold function	26	8.17 mg/l (ppm) mode—Program P5.0: Adjusting LCD brightness.....	54
7. Backlit LCD	27	8.18 mg/l (ppm) mode—Program P6.0: Resetting to factory default.....	55
8. Advanced SETUP functions	28-55	9. Probe care and maintenance.....	56-60
8.1 Advanced setup mode overview.....	29-31	9.1 pH electrode care	56-57
pH measurement mode overview	29	9.2 DO probe care	57
% saturation measurement mode overview	30	9.3 Membrane replacement	58-59
mg/l (ppm) measurement mode overview.....	31	9.4 Electrolyte solution	60
8.2 pH mode—Program P1.0: Viewing previous calibration data.....	32	10. Troubleshooting	61
8.3 pH mode—Program P2.0: Viewing electrode data.....	33-34	11. Error Messages	62
P2.1 Electrode offset	33	12. Specifications	63
P2.2 Electrode slope	34	13. Accessories	64-65
8.4 pH mode—Program P3.0: pH measurement configuration.....	35-37	14. Appendix 1: Meter theory	66
P3.1 READY indicator and auto endpoint function.....	35	15. Appendix 2: Pressure vs. Altitude table.....	67
P3.2 Selecting number of pH calibration points.....	36	16. Appendix 3: Factory default settings.....	68
P3.3 Selecting °C or °F	37	17. Warranty	69
		18. Return of Items.....	69



1. Introduction

Thank you for selecting an OAKTON meter. This OAKTON portable meter is a microprocessor-based instrument that measures pH, dissolved oxygen and temperature. It's completely waterproof—and it floats! Your meter has many user-friendly features, all of which are accessible through the membrane keypad.

Your meter includes batteries. Please read this manual thoroughly before operating your meter.

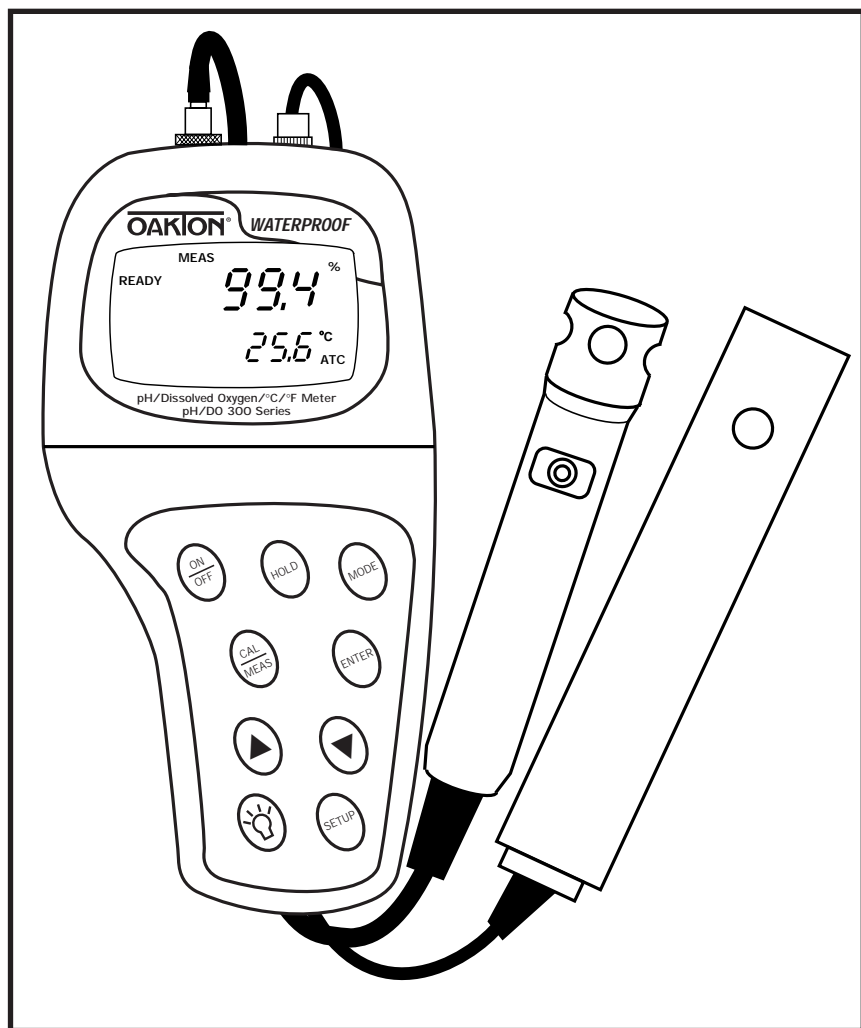

2. Display and Keypad Functions

2.1 Display

The LCD has a primary and secondary display.

- The primary display shows the measured pH or dissolved oxygen reading.
- The secondary display shows the temperature of the reading.

The display also shows error messages, keypad functions and program functions.

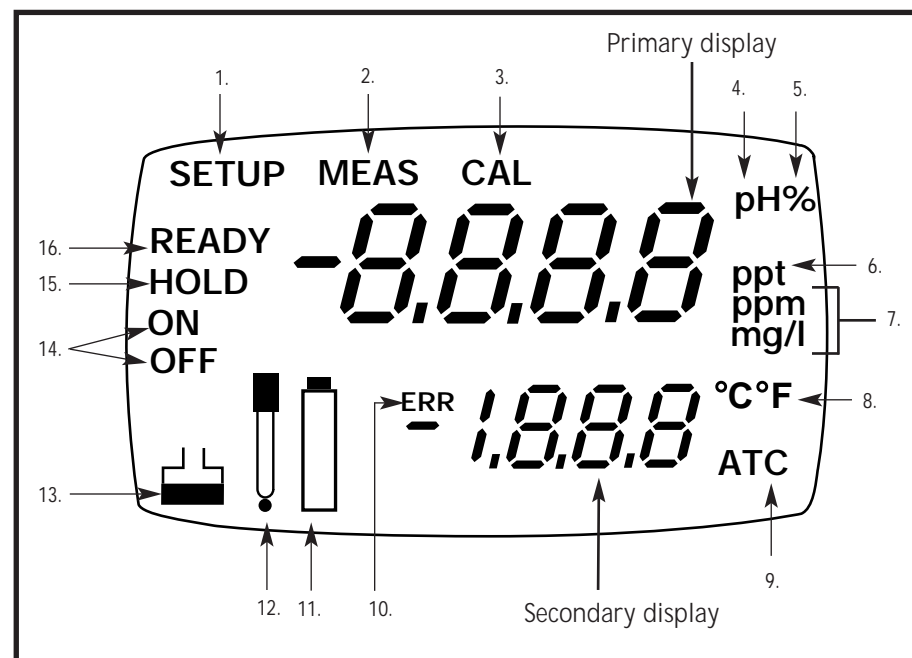

- | | | |
|---------------------------------|---|-------------------------------|
| 1. SETUP mode indicator | 8. Temperature indicators | 14. Function ON/OFF indicator |
| 2. MEASurement mode indicator | 9. Automatic Temperature Compensation indicator | 15. HOLD indicator |
| 3. CALibration mode indicator | 10. ERRor indicator | 16. READY indicator |
| 4. pH indicator | 11. Low battery indicator | |
| 5. % saturation indicator | 12. Probe indicator | |
| 6. Salinity input indicator | 13. Calibration data indicator | |
| 7. Oxygen solubility indicators | | |



2.2 Keypad

The large membrane keypad makes the instrument easy to use. Each button, when pressed, has a corresponding graphic indicator on the LCD.

ON/OFF.....Powers and shuts off the meter.

HOLDFreezes the measured reading. To activate, press **HOLD** while in measurement mode. To release, press **HOLD** again.

NOTE: When auto endpoint feature is switched on, it automatically holds reading after 5 seconds of stability. The HOLD indicator appears on the display. Press HOLD to release.

MODE.....Selects the measurement parameter. Press MODE to toggle between pH; DO % saturation; DO mg/l (ppm). In pH and DO mg/l (ppm) calibration modes press MODE to access temperature calibration. **NOTE:** To switch between mg/l and ppm modes, see page 52.

CAL/MEAS.....Toggles user between Calibration and Measurement mode.

- If you were in pH mode, press **CAL/MEAS** to enter pH calibration mode.
- If you were in DO % saturation mode, press **CAL/MEAS** to enter DO % saturation calibration mode.
- If you were in DO mg/l (ppm) mode, press **CAL/MEAS** to enter DO mg/l (ppm) calibration mode.

NOTE: Temperature calibration is available from both pH and DO mg/l (ppm) calibration modes; see page 19 for directions.

In advanced set-up mode: Press **CAL/MEAS** to return to main menu from sub menus. Press **CAL/MEAS** again to return to measurement mode from main menu.

ENTERPress to confirm values in Calibration mode and to confirm selections in **SETUP** mode.

▲ / ▼Press in **SETUP** mode to scroll through subgroups. Also lets you increment/decrement the values in the mg/l and temperature calibration modes.

SETUPPress to enter **SETUP** mode. **SETUP** mode lets you customize meter preferences and defaults, and view calibration and probe data.

LIGHT**LIGHT** Press to activate backlit display.

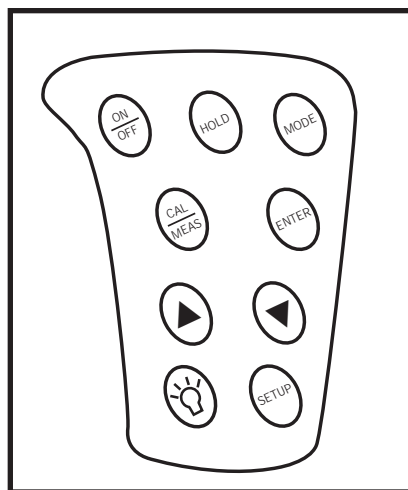

3. Preparation

3.1 Inserting the Batteries

Four AAA batteries are included with your meter.

1. Use a Phillips screwdriver to remove the two screws holding the battery cover. See figure below.
2. Lift off battery cover to expose batteries.
3. Insert batteries. Follow the diagram inside the cover for correct polarity.
4. Replace the battery cover into its original position. Screw cover back into place.

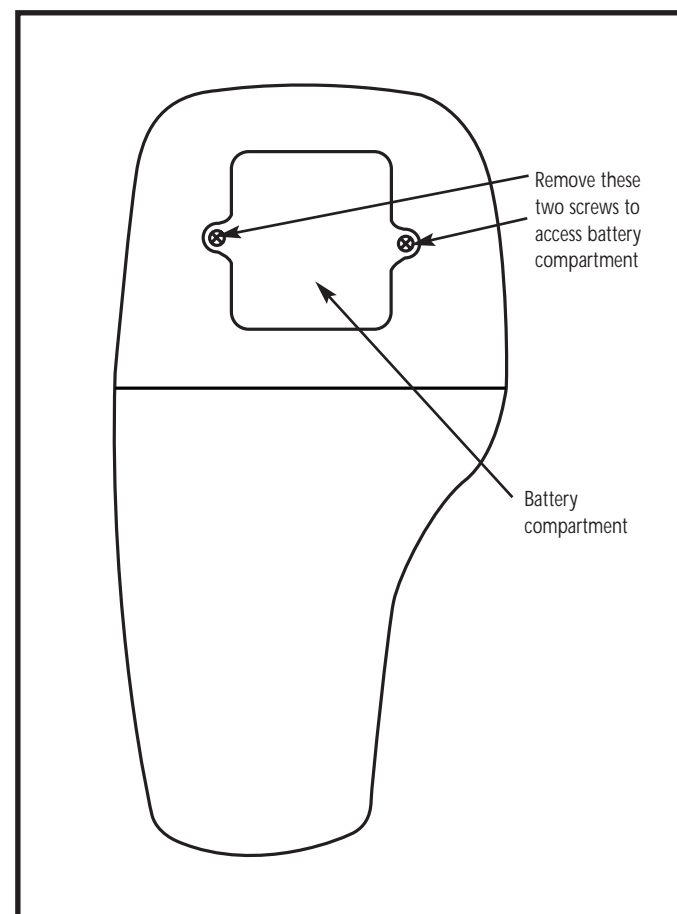



3.2 Probe information

Your meter uses two probes:

- **pH electrode** with BNC connector
- **dissolved oxygen/temperature probe** with a notched 6-pin connector

The temperature sensing element built into the dissolved oxygen probe will also compensate for pH readings as long as both probes are in your solution at the same time.

You can use any standard pH electrode with a BNC connector with this meter.

If you do not have the DO probe connected you will need temperature probe 35618-05 to provide temperature compensation for pH readings (not included order separately). For the dissolved oxygen/temperature probe, you must use an OAKTON dissolved oxygen/temperature probe with the notched 6-pin connector. For replacement probes, see the "Accessories" section, pages 64-65.

NOTE: Keep connectors dry and clean. Do not touch connectors with soiled hands.

To connect the pH electrode:

1. Slide the BNC connector of the probe over the BNC connector socket on the meter. Make sure the slots of the connector are in line with the posts of the socket. Rotate and push the connector clockwise until it locks.

See figure below.

2. To remove probe, push and rotate the connector counterclockwise. While holding onto the metal part of the connector, pull probe away from the meter.

CAUTION: Do not pull on the probe cord or the probe wires might disconnect.

To connect the dissolved oxygen probe:

NOTE: Do not substitute other DO probes. For a replacement DO probe, see the "Accessories" section, page 64.

1. Line up the notch and 6 pins on the meter with the holes in the 6-pin connector. Push down and turn the locking ring clockwise to lock into place.

See figure below.

2. To remove probe, turn the locking ring counterclockwise on the probe connector. Pull probe away from the meter.

CAUTION: Do not pull on the probe cord or the probe wires might disconnect.

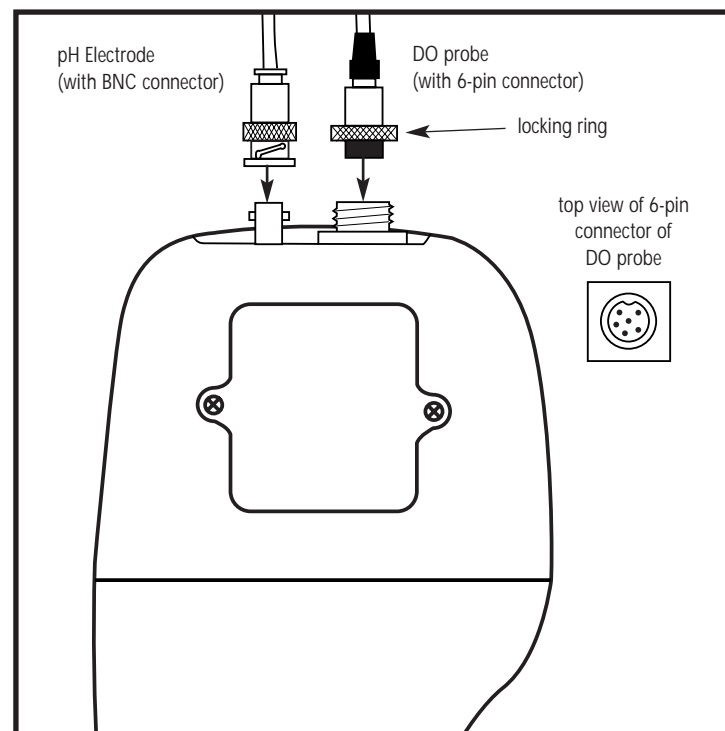



4. Calibration

4.1 Important Information on Meter Calibration

When you recalibrate your meter, old calibration points are replaced on a “point by point” basis in pH and completely for % saturation and mg/l (ppm).

For example:

- **pH:** if you previously calibrated your meter at pH 4.01, 7.00, and 10.01, and you recalibrate at pH 7.00, the meter retains the old calibration data at pH 4.01 and pH 10.01.
- **% saturation and mg/l (ppm):** All new calibrations automatically override existing calibration data.

To view current calibration points:

- **pH:** Program P1.0 in the SETUP section, page 32.
- **% saturation:** Program P3.0 in the SETUP section, page 41.
- **mg/l (ppm):** Program P2.0 in the SETUP section, page 49.

To completely recalibrate your meter, or when you use replacement probes, it is best to clear old calibration data by resetting the meter.

To reset the meter to its factory defaults:

- **pH:** Program P4.0 in the SETUP section, page 38.
- **% saturation:** Program P7.0 in the SETUP section, page 46.
- **mg/l (ppm):** Program P6.0 in the SETUP section, page 55.

NOTE: Resetting the meter will set meter to factory defaults. pH, % saturation and mg/l (ppm) must be reset separately.

For directions on how to calibrate your meter:

- See sections 4.2-4.3 on pages 11-13 for pH calibration
- See section 4.4-4.5 on page 14-16 for % saturation calibration
- See section 4.4 and 4.6 on page 14, 17-18 for mg/l (ppm) calibration
- See section 4.7 on pages 19 for Temperature Calibration

4.2 Preparing the Meter for pH Calibration

Before starting pH calibration, make sure you are in the correct measurement mode. When you switch on the meter, the meter starts up in the units last used. For example, if you shut the meter off in "pH" units, the meter will read "pH" units when you switch the meter on.

Do not reuse pH calibration solutions after calibration. Contaminants in the solution can affect the calibration, and eventually the accuracy of the measurements. See pages 64-65 for information on our high-quality pH calibration solutions.

Be sure to remove the protective rubber cap from the pH electrode before calibration or measurement. If the electrode has been stored dry, wet the probe in tap water for 10 minutes before calibrating or taking readings to saturate the pH electrode surface and minimize drift.

Wash your probe in deionized water after use, and store in electrode storage solution. If storage solution is not available, use pH 4.0 or 7.0 buffer.

The pH/DO 300 meter is capable of up to 5-point pH calibration at pH 1.68, 4.01, 7.00, 10.01, and 12.45 to ensure accuracy across the entire pH range of the meter. The meter automatically recognizes and calibrates to these standard buffer values, which makes pH calibration faster and easier.

To calibrate at 5 points you must select a 5-pt calibration in SETUP mode program P3.2 on page 36. You can select 2, 3, 4 or 5 calibration points for pH calibration.

4.3 pH calibration

NOTE: We recommend that you perform at least a 2-point calibration using standard buffers that bracket (one above and one below) the expected sample range. You can perform a 1-point calibration, but make sure that the buffer value is close to the sample value you are measuring.

The temperature sensing element is in the DO probe. For temperature compensated readings and calibration, immerse the DO probe into the calibration buffer while calibrating pH.

pH Calibration

1. If necessary, press the **MODE** key to select **pH** mode. The pH indicator appears in the upper right hand corner of the display.

See figure **A**

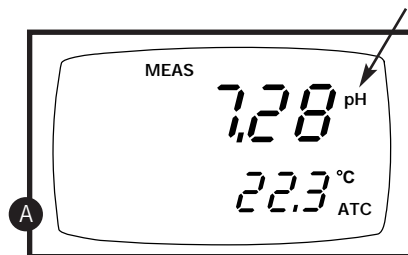

2. Rinse the pH electrode and DO probe thoroughly with de-ionized water or a rinse solution. Do not wipe the probe; this causes a build-up of electrostatic charge on the glass surface.

3. Dip both probes into the calibration buffer. The end of both probes must be completely immersed into the sample. Stir the probe gently to create a homogeneous sample.

4. Press **CAL/MEAS** to enter pH calibration mode. The CAL indicator lights. The primary display will show the measured reading while the smaller secondary display will indicate the pH standard buffer solution.

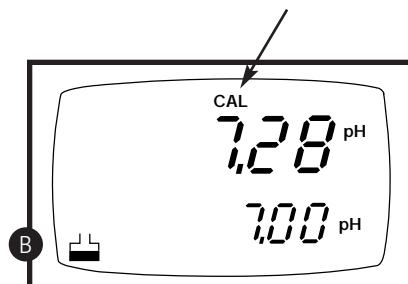

See figure **B**

5. Wait for the measured pH value to stabilize.

See figure **C**

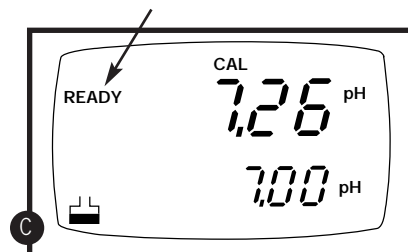

If the **READY** indicator has been activated (set up program P3.1—see page 35), the **READY** annunciator lights when the reading is stable.

6. Press **ENTER** to confirm calibration.

The meter is now calibrated to the current buffer.

See figure **D**

- If you are performing multipoint calibration, go to step 7.
- If you are performing one-point calibration, go to step 9.

7. Rinse the probe with de-ionized water or a rinse solution, and place it in the next pH buffer.

8. Follow steps 5 to 8 for additional calibration points.

9. When calibration is complete, press **CAL/MEAS** to return to pH measurement mode.

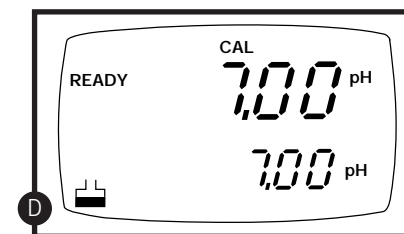

Notes

To exit from pH Calibration mode without confirming calibration, DO NOT press **ENTER** in step 6. Press **CAL/MEAS** instead.

If the selected buffer value is not within ± 1.0 pH from the measured pH value: the electrode and buffer icon blink and the **ERR** annunciator appears in the lower left corner of the display.

To limit the number of pH buffer values available during calibration, see section P3.2 on page 36.



4.4 Preparing the meter for DO calibration

Before calibrating your meter, make sure to rinse the DO probe well with de-ionized water or rinse solution.

NOTE: Do not let membrane surface of the DO probe touch any other surface. The DO probe guard (the piece with holes fitted over the end of the probe) protects the membrane; make sure this is always attached to the probe while it is in use.

You can calibrate for dissolved oxygen in either % saturation or mg/l (ppm). **All new DO calibrations automatically override existing DO calibration data.**

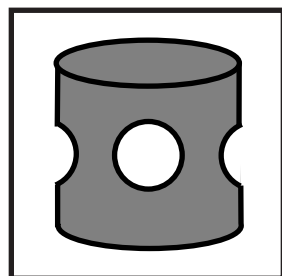

DO Probe guard

Before Dissolved Oxygen calibration

Before starting DO calibration, make sure you are in the correct measurement mode. When you switch on the meter, the meter starts up in the units last used (either pH, mg/l, ppm, % saturation). For example, if you shut the meter off in “mg/l” units, the meter will read “mg/l” units when you switch the meter on.

NOTE: Most users will calibrate to 100% saturation even when working in mg/l. When calibrating the meter in mg/l mode, you can make fine adjustments, typically to a midrange value between 10 and 100%. If you are calibrating to a midrange value, you need to set the 100% saturation value first.

4.5 Dissolved Oxygen calibration in percent saturation

You can calibrate this meter quickly and easily in air. The exact calibration value depends on barometric pressure. The meter is set to a factory default of 760 mm Hg, which results in a calibration value of 100% saturation in air.

NOTE: If the barometric pressure setting has been changed from 760 mm Hg, the calibration value in air will automatically adjust to a value other than 100%. The adjusted value will be correct for the new barometric pressure setting.

- See page 39 to change the pressure setting.
- See Appendix 2 on page 67 for a chart of adjusted % saturation values.

To calibrate 100 % saturation:

1. **Rinse the probe well with deionized rinse water or rinse solution.** For best accuracy, wrap the end of the probe in a damp cloth. Do not touch the membrane.
2. **Press the MODE key** to select the % saturation mode.

See figure **A**

3. **Press the CAL key.** The CAL indicator will appear above the primary display. The primary display shows the current value of the measurement and the secondary display will show 100.0 (see NOTE above).

See figure **B**

4. **Hold the probe in the air (or in damp cloth).** Wait for the reading to stabilize. If the Ready indicator feature is enabled, it will appear when the reading is stable (see page 43 for Ready indicator setup).
5. **Press the ENTER key.** The meter automatically calibrates to 100.0% air saturation and returns to Measurement mode.

See figure **C**

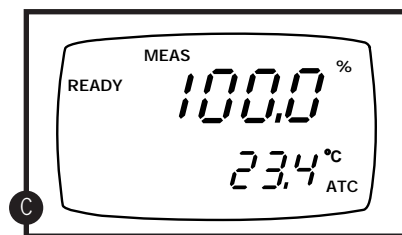
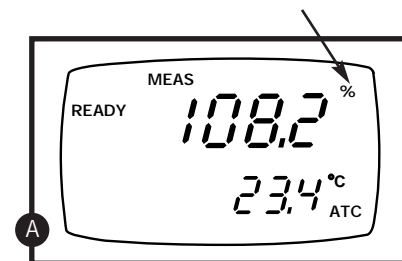

Notes

The reading in the primary display in step 3 must read at 50% or above for the calibration to work correctly. Whenever an error occurs during calibration, the ERR indicator appears in the lower left hand corner of the display.

You can offset your % DO calibration: see page 40 for directions.



To calibrate 0 % saturation:

1. **Rinse the probe well with deionized rinse water or rinse solution.** Do not touch the membrane.
2. **Press the MODE key** to select the % saturation mode.

See figure **D**

2. **Place the probe in zero oxygen solution.** Stir the probe gently to homogenize the sample. Make sure that the sample is continuously flowing past the membrane sensor.

3. **Press the CAL key.** The CAL indicator will appear above the primary display. The primary display shows the current value of the measurement and the secondary display will show 0.0.

See figure **E**

4. **Wait for the reading to stabilize.** If the Ready indicator feature is enabled, it will appear when the reading is stable (see page 43 for Ready indicator setup).

5. **Press the ENTER key.** The meter automatically calibrates to 0.0% saturation and returns to Measurement mode.

See figure **F**

Notes

The reading in the primary display in step 3 must read at 10% or under for the calibration to work correctly. Whenever an error occurs during calibration, the ERR indicator appears in the lower left hand corner of the display.

You can offset your % DO calibration: see page 40 for directions.

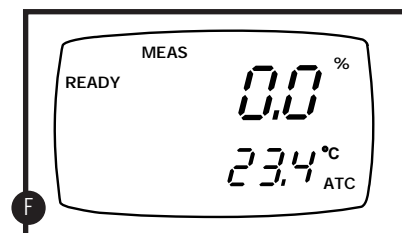
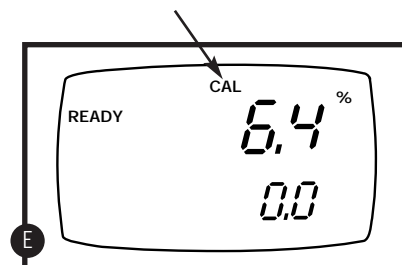
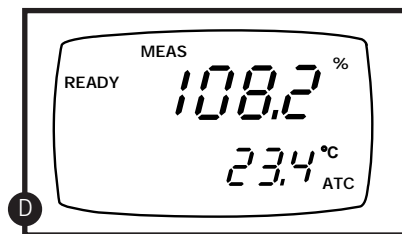

4.6 Dissolved Oxygen calibration in mg/l (ppm) mode

Calibrating the meter to 100 % in saturation mode will also calibrate the mg/l mode at the value in mg/l corresponding to 100% saturation. This should produce acceptable results in most applications.

This meter also lets you make a calibration adjustment in mg/l (ppm) mode without affecting your % saturation calibration.

To select between mg/l and ppm units, see page 52.

To calibrate in mg/l (ppm) mode:

1. Calibrate 100% saturation per section 4.5 on page 15.

2. **Rinse the probe well with deionized rinse water or rinse solution.** Wipe the outside of the probe carefully (do not touch the membrane).

3. **Dip the probe into a sample of known oxygen concentration.** Wait for the reading to stabilize. If the Ready indicator feature is enabled, it will appear when the reading is stable (see page 43 for Ready indicator setup).

NOTE: The sample must continuously flow past the membrane for accurate readings. A stirrer can keep the solution agitated; order a magnetic stirrer on page 65.

4. **Press the MODE key** to select the mg/l (ppm) mode.

See figure **A**

5. **Press the CAL key.** The CAL indicator will appear above the primary display. The primary display shows the current value of the measurement and the secondary display shows the temperature.

See figure **B**

6. **Press the ▲ and ▼ keys** to adjust the reading.

7. **Press the ENTER key.** The meter automatically calibrates to the value you entered and returns to Measurement mode.

See figure **C**

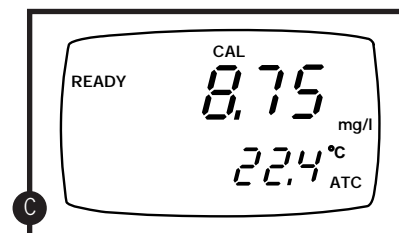
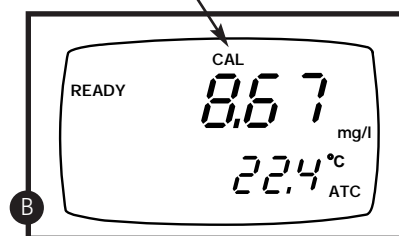
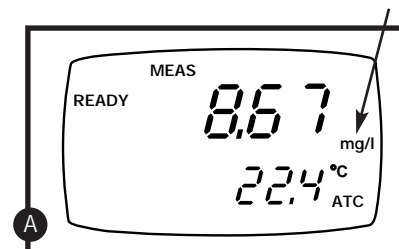



Notes on mg/l (ppm) mode calibration

During mg/l (ppm) calibration, the meter adjusts to the barometric pressure value that is programmed into the meter. It also adjusts to the salinity value that is programmed into the meter.

You can change the barometric pressure value and salinity value in the mg/l (ppm) SETUP mode (see pages 47-48 for directions).

Whenever an error occurs during calibration, the ERR indicator appears in the lower left hand corner of the display.

4.7 Temperature Calibration

The built-in temperature sensor included in the DO probe is factory calibrated. Calibrate your sensor only if you suspect sensor drift that may have occurred over a long period of time or if you have a replacement DO probe. Make sure DO probe is attached before you perform the temperature calibration.

1. Switch the meter on. Press MODE to select either pH or mg/l (ppm) Measurement mode.
2. **Press the CAL/MEAS key to enter pH or mg/l (ppm) calibration mode.** The CAL indicator will appear above the primary display.

See figure **A**

3. **While in pH or mg/l (ppm) calibration mode, press the MODE key to enter temperature calibration mode.** The primary display shows the last set temperature reading and the secondary display shows you the factory default temperature value.

See figure **B**

4. **Compare the primary display reading to a NIST-traceable thermometer or another thermometer known to be accurate.**
5. **Press the ▲ or ▼ keys to adjust the primary display reading to agree with your temperature standard.**

See figure **C**

6. **Press the ENTER key to confirm temperature calibration and return to Measurement mode.**

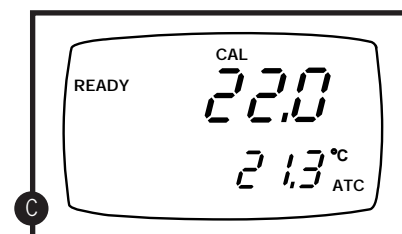
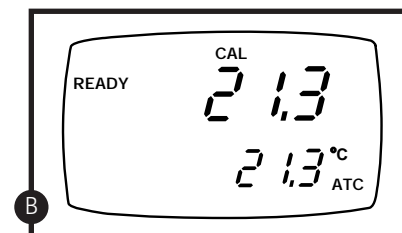
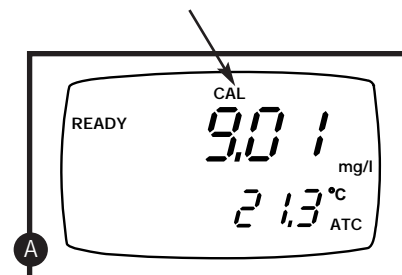

Notes

To exit from Temperature Calibration mode without confirming calibration, DO NOT press ENTER in step 6. Press CAL/MEAS instead.

Temperature calibration is restricted to $\pm 5^{\circ}\text{C}$ from the factory default value displayed during calibration (shown in the secondary display).

5. Measurement

5.1 Taking DO readings

During measurement, the probe can be:

- fully immersed in the solution
- partially immersed in the solution

Do not allow the probe's membrane surface to touch anything! The probe guard (the piece with holes fitted over the end of the probe) protects the membrane; you should leave this piece attached to the probe at all times.

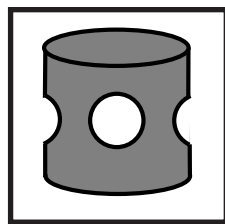

Probe guard

IMPORTANT: since the DO probe consumes oxygen from the sample, the sample must constantly flow past the membrane to achieve more accurate readings. You can use a stirrer to accomplish this (see "Accessories" on page 65 for a magnetic stirrer).

To take measurements:

1. **Rinse the probe well with deionized rinse water or rinse solution.**
2. **Select the appropriate measurement mode. Press the MODE key to toggle between modes:**
 - % saturation.
 - mg/l (ppm)**.
 - pH
3. **Dip the probe into the sample.** Stir the probe gently to homogenize the sample. Make sure that the sample is continuously flowing past the membrane sensor.
4. **Note the reading on the display.** If the READY indicator is switched on, it will appear when the reading is stable.

See figure **A**

**To select between mg/l and ppm units, see page 52.

The **ATC** indicator should appear in the lower right hand corner of the display. If it does not, this indicates an error.

CONTINUED ON NEXT PAGE

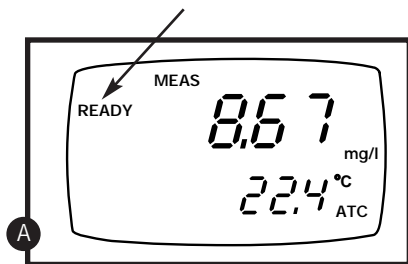

Taking measurements with READY indicator selected on

If the READY indicator has been activated, the **READY** annunciator lights when the reading is stable. Switch the READY indicator on or off in the SETUP program P5.1 for % saturation measurements (page 43) or program P4.1 (page 51) for mg/l (ppm) measurements.

Taking measurements with the auto endpoint feature selected on

When a reading is stable for more than 5 seconds, the auto endpoint feature will automatically "hold" the reading. The "hold" indicator appears on the left side of the display. Press the HOLD key to release the reading. Switch the Auto endpoint feature on or off in the SETUP program P5.1 for % saturation measurements (page 43) or program P4.1 (page 51) for mg/l (ppm) measurements.

5.2 Taking pressure/salinity compensated DO measurements

If necessary, you can adjust the pressure and salinity values of your measurements in the SETUP mode. The DO meter will automatically compensate for salinity and pressure based on the values entered in the setup functions. The meter is factory set at 760 mm Hg (101.3 Pascals) pressure adjustment and a factor of 0.0 salinity adjustment. See Appendix 2 on page 67 for a "Pressure vs Altitude" table.

Pressure adjustment

NOTE: This adjustment appears in both the % saturation and mg/l (ppm) measurement modes.

1. **Press the MODE key** to select % saturation or mg/l (ppm) mode. **Press the SETUP key** to enter Set Up mode.

See figure **A**

2. **Press the ENTER key** until the upper display shows a number and the lower display shows "Hg" or "PA".

3. **Use the ▲ and ▼ keys** to enter the barometric pressure. The upper display will show the value you have entered.

See figure **B**

4. **Press ENTER** to confirm pressure value.
5. **Press CAL/MEAS** to return to measurement mode, or continue with step 4 on page 22 to make a salinity adjustment [available from mg/l (ppm) mode only].

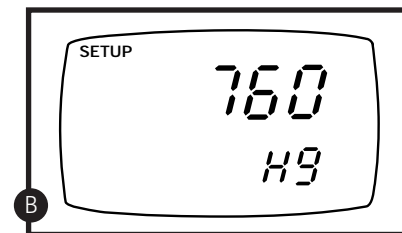
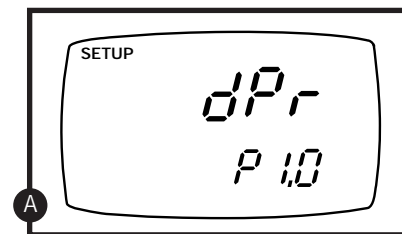



Salinity adjustment

NOTE: *this mode appears in mg/l (ppm) measurement mode only.*

1. Press the Mode key to select mg/l (ppm) mode.
2. Press the SETUP key to enter Set Up mode.

See figure A

4. Press the ENTER key until the upper display shows a number and the lower display shows "SAL".
5. Use the ▲ and ▼ keys to enter the salinity of your solution in ppt. The upper display will show the value you have entered.

See figure B

6. Press the ENTER key to confirm value.
7. Press CAL/MEAS to return to Measurement mode.

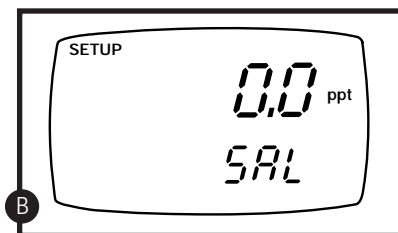
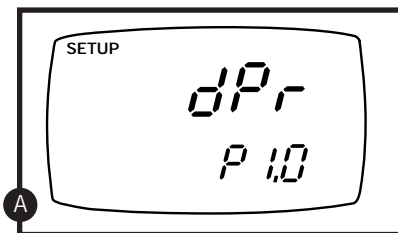

5.3 Taking pH Measurements

Be sure to remove the protective rubber cap on the electrode before measurement. To ensure Automatic Temperature Compensation (ATC) for pH measurements, the DO probe must be plugged in and must be immersed into the sample you wish to take pH readings.

To take readings:

1. Rinse the pH electrode with deionized or distilled water before use to remove any impurities adhering to the probe body. If the pH electrode has dehydrated, soak it for 30 minutes in OAKTON electrode storage solution or a 2M-4M KCl solution.
2. Press ON to switch on meter. Press MODE key to select pH measurement mode. The MEAS annunciator appears on the top center of the LCD. The ATC indicator appears in the lower right hand corner to indicate Automatic Temperature Compensation. If the ATC indicator does not appear, make sure DO probe is plugged into the meter.

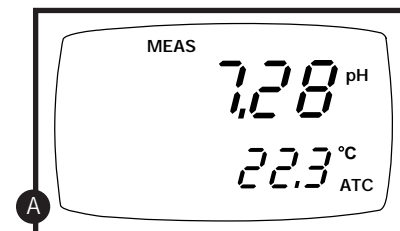

See figure A

3. Dip both the pH electrode and the DO probe into the sample.

When dipping the pH electrode into the sample, the sensor or the glass bulb of the electrode must be completely immersed into the sample. Stir the probe gently in the sample to create a homogenous sample.

4. Allow time for the reading to stabilize. Note the reading on the display.
5. Press the MODE key to toggle between modes:
 - pH
 - % saturation.
 - mg/l (ppm)**

**To select between mg/l and ppm units, see page 52.

The ATC indicator should appear in the lower right hand corner of the display. If it does not, this indicates an error.

CONTINUED ON NEXT PAGE



Taking measurements with READY indicator selected on

If the READY indicator has been activated, the **READY** annunciator lights when the reading is stable. Switch the READY indicator on or off in Set up program P3.1—see page 35 for directions.

Taking measurements with the auto endpoint feature selected on

When a reading is stable for more than 5 seconds, the auto endpoint feature will automatically “HOLD” the reading. The “HOLD” indicator appears on the left side of the display. Press the HOLD key to release the reading. Switch the Auto endpoint feature on or off in Set up program P3.1—see page 35 for directions.

5.4 Manual Temperature Compensation

IMPORTANT: For manual compensation, you must disconnect the DO or temperature probe (see page 9).

1. Switch the meter on. **Press the MODE key** to select pH mode.
2. **Press the CAL/MEAS key** to enter pH calibration mode. The CAL indicator will appear above the primary display.
3. While in pH calibration mode, **press the MODE key** to enter temperature calibration mode. The primary display shows the current temperature setting and the secondary display shows the default value 25°C.

See figure **A**

4. **Check the temperature of your sample** using an accurate thermometer.
5. **Press the ▲ or ▼ keys** to offset the temperature to the measured value from step 4.

See figure **B**

6. **Press ENTER** to confirm the selected temperature and to return to the pH measurement mode.

The meter will now compensate pH readings for the manually set temperature.

Notes

To exit this program without confirming the manual temperature compensation value, **DO NOT** press **ENTER** in step 6. Press **CAL/MEAS** instead.

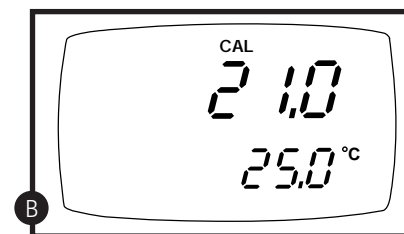
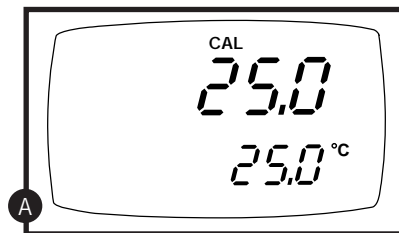



6. HOLD function

This feature lets you freeze the value of the pH, % saturation or mg/l (ppm) and temperature readings for a delayed observation. **HOLD** can be used any time when in **MEAS** mode.

1. To hold a measurement, press the **HOLD** key while in measurement mode. The “HOLD” annunciator will appear on the display.

See figures **A** and **B**

2. To release the held value, press **HOLD** again. Continue to take measurements.

NOTE: This meter shuts off automatically after 20 minutes of nonuse. If the meter is shut off either automatically or manually, the HOLD value will be lost.

NOTE: This meter has an auto endpoint feature. When this feature is switched on, the display will automatically “HOLD” a reading that has been stable for more than 5 seconds. The “HOLD” indicator appears. Press the HOLD key to release the reading. To switch on or off the auto endpoint feature, see the **SETUP** program P3.1 on page 35 for pH, P5.1 on page 43 for % saturation and P4.1 on page 51 for mg/l (ppm).

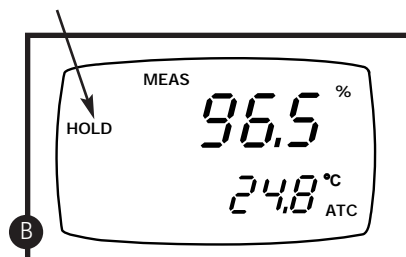
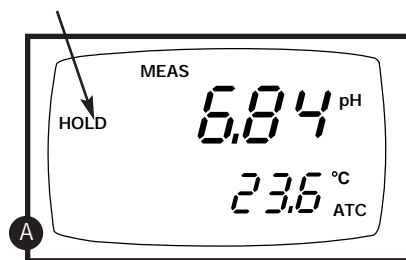

7. Backlit LCD

Using the backlit LCD

This feature lets you view readings in low light situations.

1. To activate the backlit LCD feature, press the key to activate.

See figure **A**

To keep the LCD backlit, keep the key pressed. If the key is not pressed, the backlight automatically shuts off automatically after 20 seconds after pressing the key.

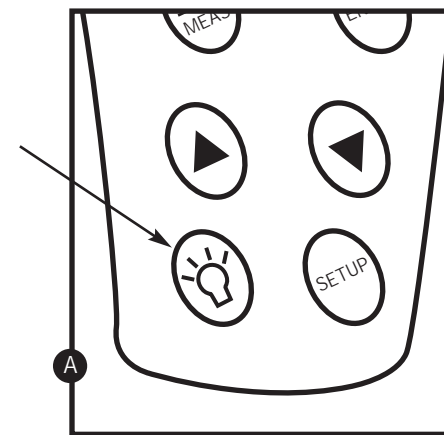

Adjusting LCD brightness

This mode lets you adjust the brightness of the backlit LCD. Selecting a dimmer backlighting level helps conserve batteries. This adjustment is only available in the % saturation or mg/l (ppm) **SETUP** modes.

From measurement mode:

1. Press the **MODE** key to switch to % saturation or mg/l (ppm) mode.
2. Press **SETUP** key to enter **SETUP** mode.
3. Press the **▲** and **▼** keys to scroll through subgroups until you view parameter “LCD” in the upper display.

See figure **A**

4. Press the **ENTER** key. A number (0-8) appears in the upper display and “LCD” appears in the lower display.

See figure **B**

5. Press the **▲** and **▼** keys to select from level 0 (dimmiest light) to level 8 (brightest light).
6. Press the **ENTER** key to confirm selection and to return to the subgroup menu. Press the **CAL/MEAS** key to return to measurement mode.

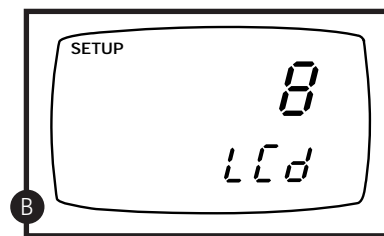
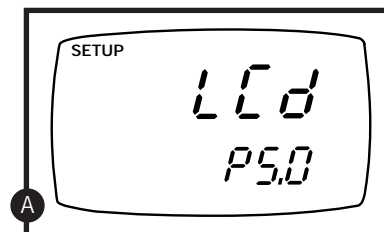



8. Advanced SETUP functions

The advanced set up mode lets you customize your meter's preferences and defaults. Your OAKTON waterproof meter features different sub groups that organize all SETUP parameters.

This meter displays different subgroups depending on which mode the meter is in:

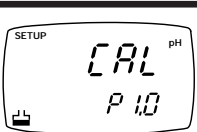
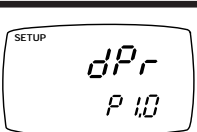
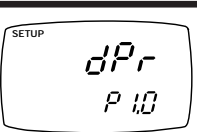
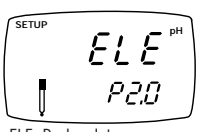
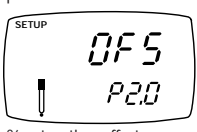
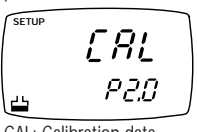
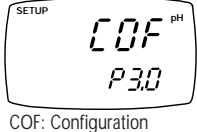
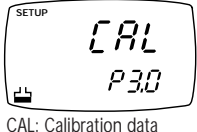
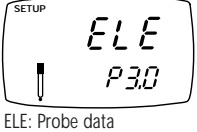
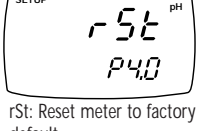
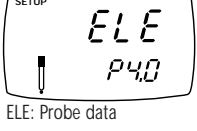
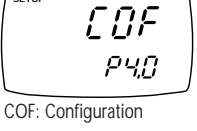
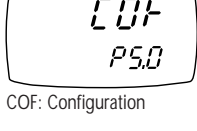
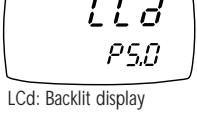
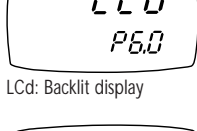
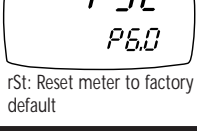
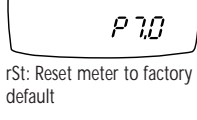
pH	% Saturation	mg/l (ppm)
 <p>CAL: Calibration data</p>	 <p>dPr: Dissolved oxygen parameters</p>	 <p>dPr: Dissolved oxygen parameters</p>
 <p>ELE: Probe data</p>	 <p>% saturation offset adjustment</p>	 <p>CAL: Calibration data</p>
 <p>COF: Configuration</p>	 <p>CAL: Calibration data</p>	 <p>ELE: Probe data</p>
 <p>rSt: Reset meter to factory default</p>	 <p>ELE: Probe data</p>	 <p>COF: Configuration</p>
	 <p>COF: Configuration</p>	 <p>Lcd: Backlit display</p>
	 <p>Lcd: Backlit display</p>	 <p>rSt: Reset meter to factory default</p>
	 <p>rSt: Reset meter to factory default</p>	

8.1 Advanced SETUP mode detailed overview

Press the SETUP key to enter SETUP mode. Press the ▲ and ▼ keys to scroll through sub groups.

From the pH measurement mode

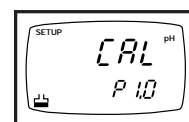

Instructions on page 32

CAL: Viewing previous calibration data

- View previous calibration data

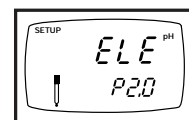

Instructions on page 33-34

ELE: Viewing electrode data

- View pH electrode offset
- View pH electrode slope

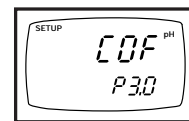

Instructions on page 35-37

COF: Unit configuration

- Ready indicator on or off / auto endpoint on or off
- number of calibration points: 2, 3, 4, or 5
- Select °F or °C

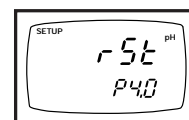

Instructions on page 38

rSt: Reset to factory default

- Reset to factory default settings



From the % saturation measurement mode

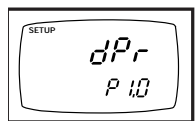

Instructions on page 39

dPr: Dissolved oxygen parameters

- Select Hg or Pa barometric pressure units
- Select barometric pressure

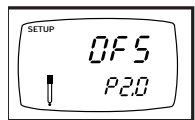

Instructions on page 40

OFS: % saturation offset adjustment

- Set % saturation offset adjustment

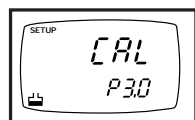

Instructions on page 41

CAL: Viewing previous calibration data

- View previous calibration data

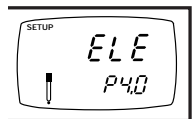

Instructions on page 42

ELE: Viewing probe data

- View probe slope
- View % saturation offset
- View mV value equivalent to 100% saturation
- View mV value equivalent to 0% saturation

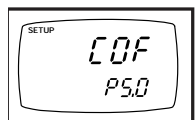

Instructions on page 43-44

COF: Unit configuration

- Ready indicator on or off / auto endpoint on or off
- Select °F or °C

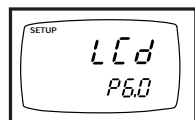

Instructions on page 45

LCd: Backlit display

- Adjust brightness of backlit LCD

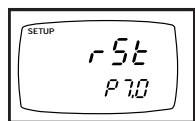

Instructions on page 46

rSt: Reset to factory default

- Reset to factory default settings

From the mg/l (ppm) measurement mode

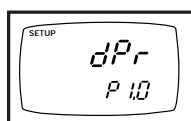

Instructions on page 47-48

dPr: Dissolved oxygen parameters

- Select Hg or Pa barometric pressure units
- Select barometric pressure
- Select salinity adjustment factor

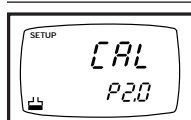

Instructions on page 49

CAL: Viewing previous calibration data

- View previous calibration data, including date/time

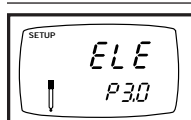

Instructions on page 50

ELE: Viewing probe data

- View probe slope
- View mV value equivalent to 100% saturation
- View mV value equivalent to 0% saturation



Instructions on page 51-53

COF: Unit configuration

- Ready indicator on or off / auto endpoint on or off
- Select mg/l or ppm units
- Select °F or °C

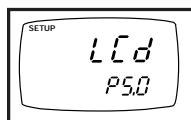

Instructions on page 54

LCd: Backlit display

- Adjust brightness of backlit LCD

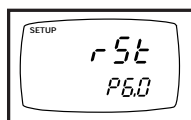

Instructions on page 55

rSt: Reset to factory default

- Reset to factory default settings



8.2 pH mode—P1.0: Viewing previous calibration data

Program P1.0 lets you recall previous calibration data, which helps you know when to recalibrate your meter. This is a “view only” mode.

From measurement mode:

1. Press the **MODE** key to select pH measurement mode.
2. Press the **SETUP** key to enter SETUP mode.

See figure **A**

3. Press the **▲** and **▼** keys to scroll through subgroups until you view parameter P1.0.
4. Press the **ENTER** key repeatedly to view previous calibration data.

P1.1 = pH 1.68
 P1.2 = pH 4.01
 P1.3 = pH 7.00
 P1.4 = pH 10.01
 P1.5 = pH 12.45

See figure **B**

5. When you have scrolled through all calibration data, you will automatically return to the subgroup menu. Press the **CAL/MEAS** key to return to measurement mode.

NOTES:

If there is no previous calibration data at a particular point, the primary display will show “----”.

See figure **C**

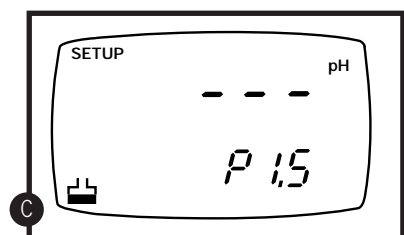
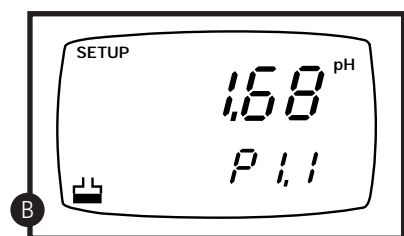
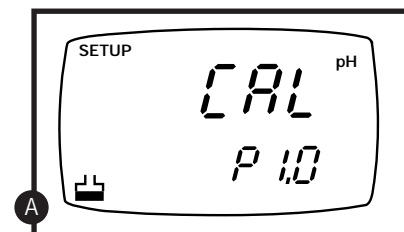

8.3 pH mode—P2.0: Viewing electrode data

Program P2.0 has two “view only” options that lets you check the electrode parameters for diagnostic purposes.

P2.1: Electrode offset

From measurement mode:

1. Press the **MODE** key to select pH measurement mode.
2. Press the **SETUP** key to enter Set Up mode.
3. Press the **▲** and **▼** keys to scroll through subgroups until you view parameter P2.0.

See figure **A**

4. Press the **ENTER** key to select parameter P2.1.
5. The display shows the electrode offset value.
 - the display shows the mV offset at pH 7.00. If you have not calibrated at any buffer, the primary display shows 0.00 mV.

See figure **B**

6. Press the **ENTER** key to proceed to step 4 of P2.2. Or, press the **CAL/MEAS** key to return to measurement mode.

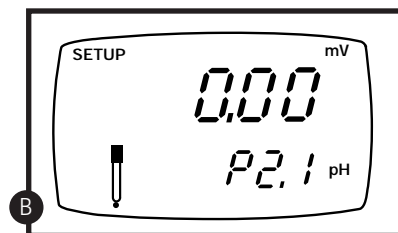
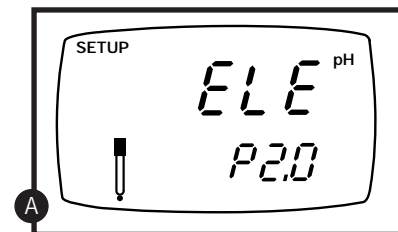



P2.2: Electrode slope

NOTE: this parameter is available in pH measurement mode only.

From measurement mode:

1. If necessary, press the **MODE** key to select pH measurement mode. Press the **SETUP** key to enter SETUP mode.
2. Press the **▲** and **▼** keys to scroll through subgroups until you view parameter P2.0.

See figure **D**

3. Press the **ENTER** key twice to select parameter P2.2.
4. The display shows electrode slope in percentage of the range you are currently measuring. Default setting is 100.0.

See figure **E**

5. Press the **ENTER** key to return to the subgroup menu. Press the **CAL/MEAS** key to return to measurement mode.

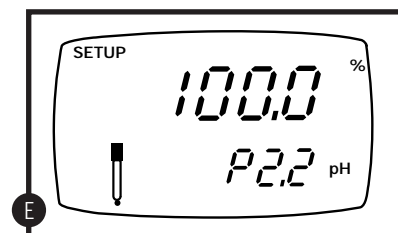
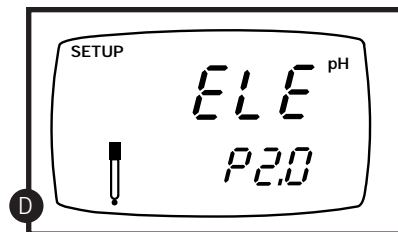

8.4 pH mode—P3.0: pH measurement configuration

P3.1: READY indicator and auto endpoint function

This program lets you select:

- **“READY indicator on”** to indicate when the reading is stable.
- **“READY indicator off”** for faster meter response.
- **Auto endpoint function on.** Select auto endpoint on to “hold” the reading when it is stable for more than 5 seconds. The display automatically freezes, and the HOLD indicator appears on the left side of the display. Press the HOLD key to release the display and access other functions.

From measurement mode:

1. Press the **MODE** key to select pH measurement mode.
2. Press **SETUP** key to enter SETUP mode.
3. Press the **▲** and **▼** keys to scroll through subgroups until you view parameter P3.0.

See figure **A**

4. Press the **ENTER** key to select parameter P3.1.

See figure **B**

5. Press the **▲** and **▼** keys to select the configuration you require.
 - OFF switches the READY indicator off.
 - ON switches the READY indicator on.
 - ON and HOLD together switches the auto endpoint feature on.
6. Press the **ENTER** key to confirm selection and to proceed to step 4 of P3.2. Press the **CAL/MEAS** key to return to measurement mode.

NOTES: Meter default is set for Ready indicator on, and auto endpoint function off.

You can also change the Ready indicator and auto endpoint function in SETUP Program P5.1 on page 43 in % saturation mode or Program P4.1 on page 51 in mg/l (ppm) mode. Any changes you make to the Ready indicator/ auto endpoint function in pH mode will also change in % saturation and mg/l (ppm) modes.

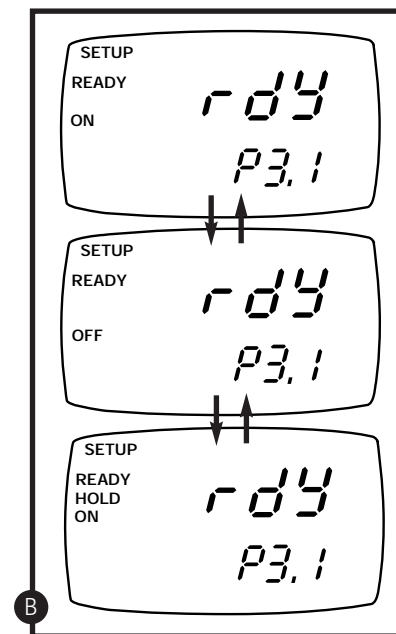
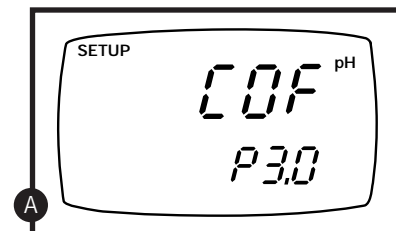



P3.2: Selecting number of pH calibration points

Program P3.2 lets you select the number of pH calibration points the meter will use in calibration mode: 2, 3, 4, or 5. The meter will automatically exit calibration mode after you have calibrated to your selected number of points.

From measurement mode:

1. Press the **MODE** key to select pH measurement mode.
2. Press **SETUP** key to enter SETUP mode.
3. Press the **▲** and **▼** keys to scroll through subgroups until you view parameter P3.0.

See figure **C**

4. Press the **ENTER** key twice to select parameter P3.2.

See figure **D**

5. Press the **▲** and **▼** keys to select 2, 3, 4, or 5 point pH calibration.
6. Press the **ENTER** key to confirm selection and to return to the subgroup menu. Press the **CAL/MEAS** key to return to measurement mode.

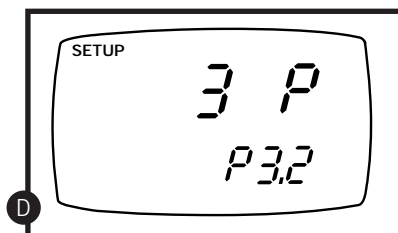
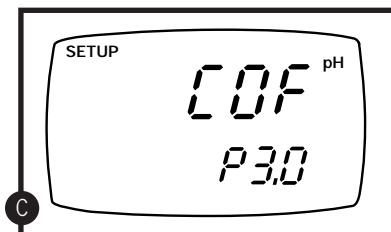

P3.3 Selecting °C or °F

This meter lets you select between °C and °F units for temperature readings.

From measurement mode:

1. Press the **MODE** key to select pH measurement mode.
2. Press **SETUP** key to enter SETUP mode.
3. Press the **▲** and **▼** keys to scroll through subgroups until you view parameter P3.0.

See figure **E**

4. Press the **ENTER** key three times to select parameter P3.3.

See figure **F**

5. Press the **▲** and **▼** keys to toggle between °C and °F.
6. Press the **ENTER** key to confirm selection and to return to the subgroup menu. Press the **CAL/MEAS** key to return to measurement mode.

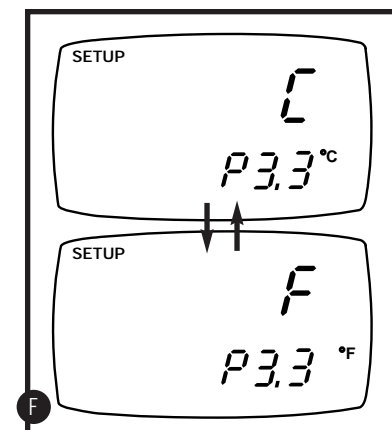
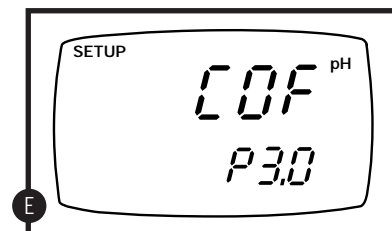

NOTES:

You can also switch between °C and °F in SETUP Program P5.2 on page 44 in % saturation mode or Program P4.3 on page 53 in mg/l (ppm) mode. If you switch between °C and °F in pH mode, the meter will also switch in % saturation and mg/l (ppm) modes.

8.5 pH mode—P4.0: Resetting to factory default settings

This program lets you reset all pH parameters to factory default settings. This clears all calibration data any other pH setup functions you might have changed. The following settings will remain as you have set them:

- Temperature unit of measure (°C or °F)
- The temperature offset calibration value
- All dissolved oxygen calibration data and parameters including the LCD contrast setting

From measurement mode:

1. Press the **MODE** key to select pH measurement mode.
2. Press **SETUP** key to enter SETUP mode.
3. Press the **▲** and **▼** keys to scroll through subgroups until you view parameter P4.0 in the lower display.

See figure **A**

4. Press the **ENTER** key.

See figure **B**

5. Press the **▲** and **▼** keys to toggle between NO and YES.
 - NO retains current settings
 - YES resets to factory default settings
6. Press the **ENTER** key to confirm selection and to return to measurement mode.

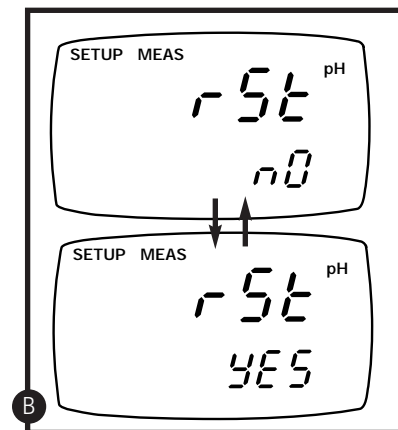
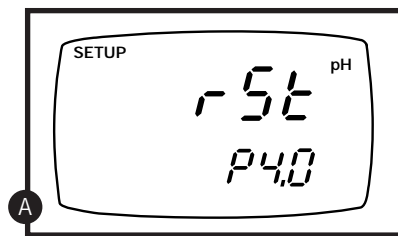
**Notes:**

To reset all % saturation data, see page 46.

To reset all mg/l (ppm) data, see page 55.

See page 68 for a table of factory default settings.

8.6 % saturation mode—P1.0: Dissolved Oxygen Parameters

This sub group lets you adjust the barometric pressure

Pressure adjustment mode

Barometric pressure is vital to correct dissolved oxygen measurements. You need to enter the correct barometric pressure of the area you are measuring. This mode lets you perform two functions:

- Select either mm Hg or Pascal barometric pressure units
- Adjust the barometric pressure. See Appendix 2 on page 67 for a “Pressure vs Altitude” table.

From measurement mode:

1. Press the **MODE** key to select % saturation mode.
2. Press the **SETUP** key to enter SETUP mode.
3. Press the **▲** and **▼** keys to scroll through subgroups until you view parameter P1.0 in the lower display.

See figure **A**

4. Press the **ENTER** key twice. The upper display shows either Hg or PA and the lower display shows bAr.
5. Press the **▲** and **▼** keys to toggle between mm Hg and Pascal units.

See figure **B**

6. Press the **ENTER** key to confirm selection and move to the next screen. The upper display shows the barometric pressure and the lower display shows the units selected in step 5.

See figure **C**

7. Press the **▲** and **▼** keys to adjust the barometric pressure. The pressure adjustment range is 500 to 1499 mm Hg (66.6 to 199.9 kPa).
8. Press the **ENTER** key to confirm selection and move to step 3 on page 40. If instead you want to return to measurement mode, press CAL/MEAS twice.

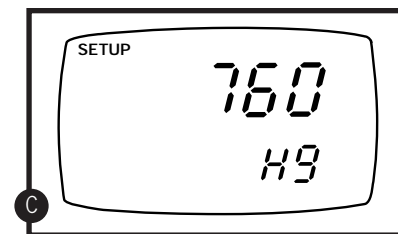
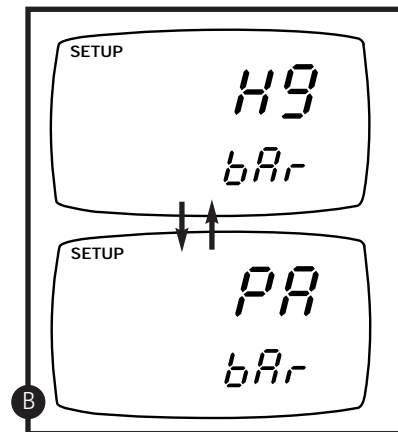
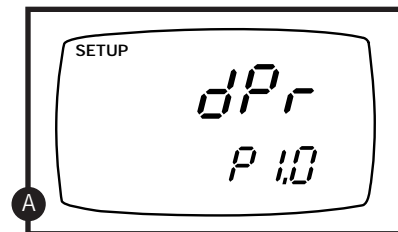



8.7 % saturation mode—P2.0: Offset Adjustment

Use the offset adjustment to act as an offset at values between 0 and 100%. It is useful to match against end-user standards (i.e. a test kit value).

From measurement mode:

1. Press the **MODE** key to select % saturation mode.
2. Press the **SETUP** key to enter SETUP mode.
3. Press the **▲** and **▼** keys to scroll through subgroups until you view parameter P2.0 in the lower display.

See figure **A**

4. Press the **ENTER** key. The upper display shows the current measurement in % saturation and the lower shows OFS.

See figure **B**

5. Press the **▲** and **▼** keys to offset the % saturation measurement.
6. Press the **ENTER** key to confirm selection and to move back to subgroup P2.0. If you want to return to measurement mode, press CAL/MEAS.

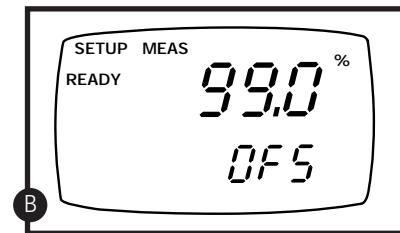
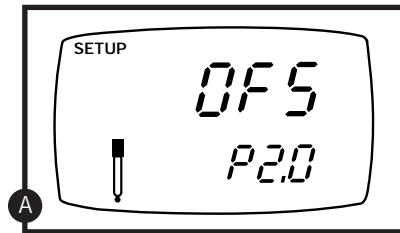

8.8 % saturation mode—P3.0: Previous calibration information

This sub group shows you the previous calibration data, along with date and time of calibration. This is a “view only” parameter.

In % saturation mode: calibration information is shown in % saturation units.

From measurement mode:

1. Press the **MODE** key to select % saturation mode.
2. Press the **SETUP** key to enter SETUP mode.
3. Press the **▲** and **▼** keys to scroll through subgroups until you view parameter P3.0 in the lower display.

See figure **A**

4. Press the **ENTER** key. The upper display shows the calibration data.

See figure **B**

6. Press the **ENTER** key to move back to subgroup P3.0. If you want to return to measurement mode, press CAL/MEAS.

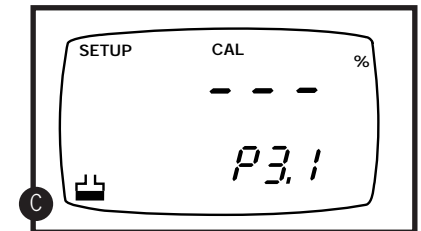
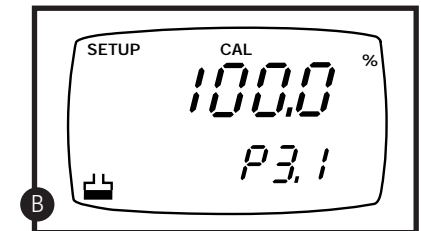
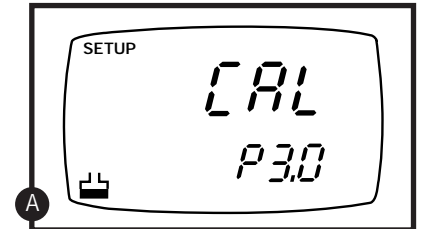

NOTE: If you did not calibrate this meter in a particular mode, the screen will show “---”.

See figure **C**



8.9 % saturation mode—P4.0: Electrode properties

These “view only” parameters show the electrode properties for diagnostic purposes:

probe slope: shows the calibration slope of the probe. This mode displays slope from 0.5 to 1.999 % of slope (1.0 = 100%).

% saturation offset: shows the value of the % saturation offset entered in parameter P2.0 (see page 40 for instructions).

100% saturation mV value: shows the sensor’s mV output corresponding to 100% saturation.

0% saturation mV value: shows the sensor’s millivolt output corresponding to 0% saturation.

From measurement mode:

1. Press the **MODE** key to select the % saturation measurement mode.
2. Press the **SETUP** key to enter SETUP mode.
3. Press the **▲** and **▼** keys to scroll through subgroups until you view parameter P4.0 in the lower display.

See figure **A**

4. Press the **ENTER** key. The upper display shows the probe slope.

See figure **B**

5. Press the **ENTER** key. The upper display shows the % saturation offset. See directions for setting this offset on page 40.

See figure **C**

6. Press the **ENTER** key. The upper display shows the 100 % saturation mV value.

See figure **D**

7. Press the **ENTER** key. The upper display shows the 0 % saturation mV value.

See figure **E**

8. Press the **ENTER** key to move back to subgroup P4.0. If you want to return to measurement mode, press **CAL/MEAS**.

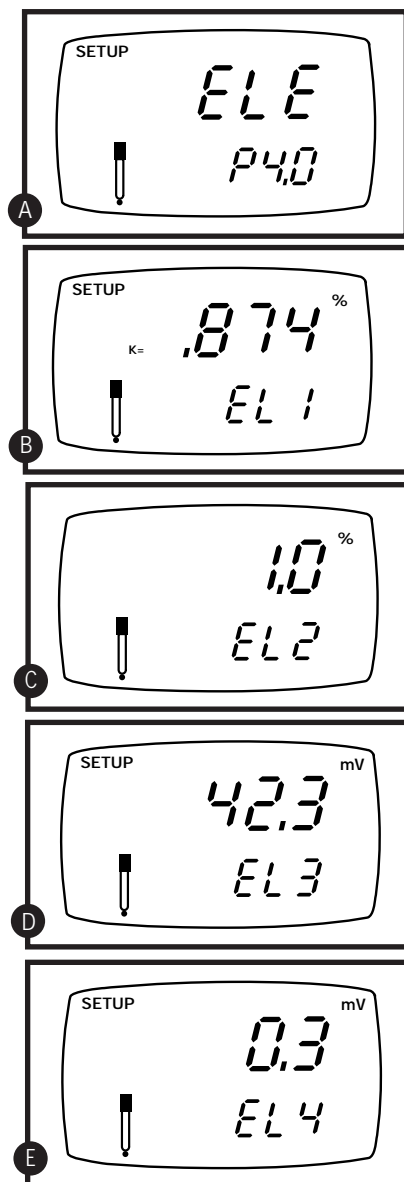

8.10 % saturation mode—P5.0: Unit configuration

Unit configuration mode lets you select the following parameters:

- A. Ready indicator and auto endpoint function
- B. Temperature in °C or °F

P5.1: READY indicator and auto endpoint function

The first program lets you select:

- “**READY indicator on**” to indicate when the reading is stable.
- “**READY indicator off**” for faster meter response.
- **Auto endpoint function on.** Select auto endpoint on to “hold” the reading when it is stable for more than 5 seconds. The display automatically freezes, and the HOLD indicator appears on the left side of the display. Press the HOLD key to release the display and access other functions.

From measurement mode:

1. Press the **MODE** key to select the % saturation measurement mode.
2. Press **SETUP** key to enter SETUP mode.
3. Press the **▲** and **▼** keys to scroll through subgroups until you view parameter P5.0 in the lower display.

See figure **A**

4. Press the **ENTER** key to select parameter P5.1 “rdY” (Ready).

See figure **B**

5. Press the **▲** and **▼** keys to select the configuration you require.
 - ON switches the READY indicator on.
 - OFF switches the READY indicator off.
 - ON and HOLD together switches the auto endpoint feature on.
6. Press the **ENTER** key to confirm selection and to move to step 3 on page 44 (P5.2). Or, press the **CAL/MEAS** key twice to return to measurement mode.

NOTES: Meter default is set for Ready indicator on, and auto endpoint function off.

You can also change the Ready indicator and auto endpoint function in SETUP Program P3.1 on page 35 in pH mode or P4.1 on page 51 in mg/l (ppm) mode. Any changes you make to the Ready indicator/ auto endpoint function in % saturation mode will also change in pH and mg/l (ppm) modes.

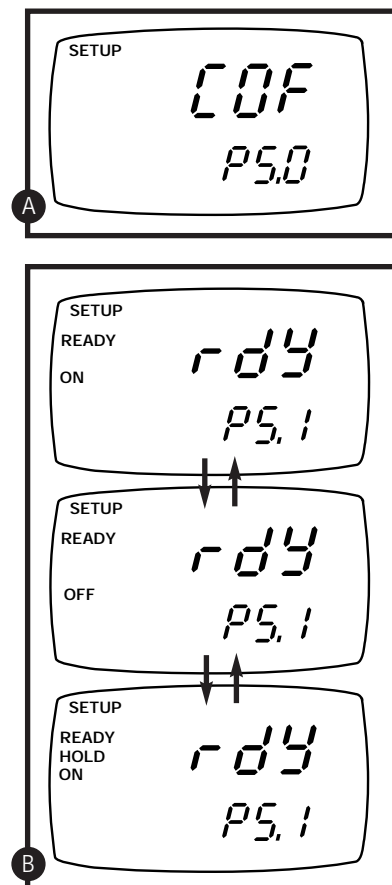

P5.2: Selecting °C or °F temperature readout

This meter lets you select between °C and °F units for temperature readings.

From measurement mode:

1. Press the **MODE** key to select the % saturation measurement mode.
2. Press **SETUP** key to enter SETUP mode.
3. Press the **▲** and **▼** keys to scroll through subgroups until you view parameter P5.0 in the lower display.

See figure **E**

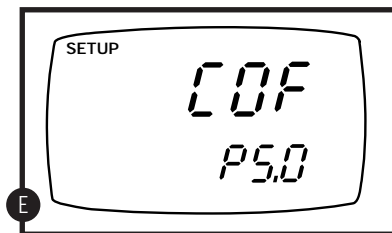

4. Press the **ENTER** key until “C” or “F” appears in the upper display.

See figure **F**

5. Press the **▲** and **▼** keys to toggle between °C and °F.
6. Press the **ENTER** key to confirm selection and to return to the subgroup menu. Press the **CAL/MEAS** key to return to measurement mode.

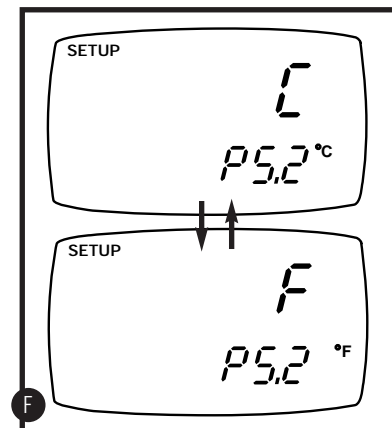
**NOTES:**

You can also switch between °C and °F in SETUP Program P3.3 on page 37 in pH mode or Program P4.3 on page 53 in mg/l (ppm) mode. If you switch between °C and °F in % saturation mode, the meter will also switch in pH and mg/l (ppm) modes.

8.11 % saturation mode—P6.0: Adjusting LCD brightness

This mode lets you adjust the brightness of the backlit LCD. Selecting a dimmer backlighting level helps conserve batteries.

From measurement mode:

1. Press the **MODE** key to select the % saturation measurement mode.
2. Press **SETUP** key to enter SETUP mode.
3. Press the **▲** and **▼** keys to scroll through subgroups until you view parameter P6.0 in the lower display.

See figure **A**

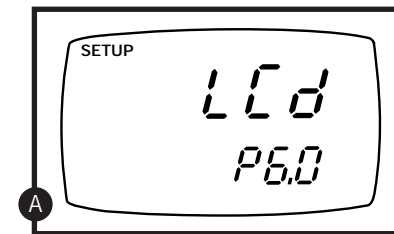

4. Press the **ENTER** key. A number (0-8) appears in the upper display and “LCD” appears in the lower display.

See figure **B**

5. Press the **▲** and **▼** keys to select from level 0 (dimnest light) to level 8 (brightest light).
6. Press the **ENTER** key to confirm selection and to return to the subgroup menu. Press the **CAL/MEAS** key to return to measurement mode.

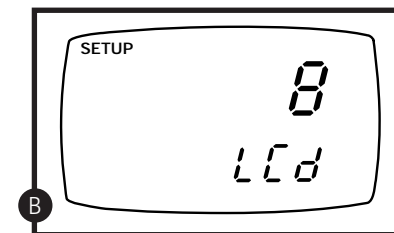

8.12 % saturation mode—P7.0: Resetting to factory default settings

This program lets you reset all parameters to factory default settings. This clears all calibration data, memory, and any other setup functions you might have changed. The LCD contrast setting will be reset to 8 (the maximum setting). However, the following settings will remain as you have set them:

- temperature unit of measure (°C or °F)
- the temperature offset calibration value
- pH calibration data and set parameters

From measurement mode:

1. Press the **MODE** key to select the % saturation measurement mode.
2. Press **SETUP** key to enter SETUP mode.
3. Press the **▲** and **▼** keys to scroll through subgroups until you view parameter P7.0 in the lower display.

See figure **A**

4. Press the **ENTER** key.

See figure **B**

5. Press the **▲** and **▼** keys to toggle between NO and YES.
 - NO retains current settings
 - YES resets to factory default settings
6. Press the **ENTER** key to confirm selection and to return to measurement mode.

Notes

To reset all pH data, see page 38.

To reset all mg/l (ppm) data, see page 55.

See page 68 for a table of factory default settings.

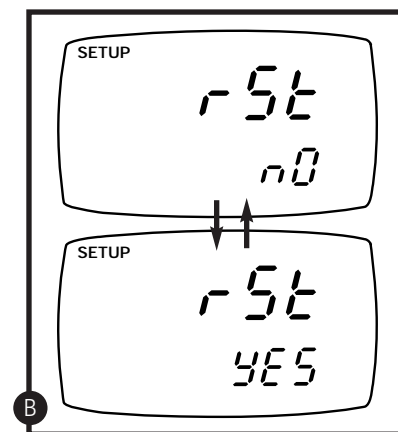
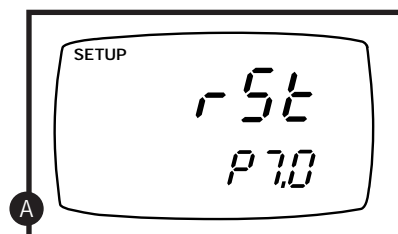

8.13 mg/l (ppm) mode—P1.0: Dissolved Oxygen Parameters

This sub group lets you adjust the barometric pressure and salinity.

P1.1 Pressure adjustment mode

Barometric pressure is vital to correct dissolved oxygen measurements. You need to enter the correct barometric pressure of the area you are measuring. This mode lets you perform two functions:

- Select either mm Hg or Pascal barometric pressure units
- Adjust the barometric pressure. See Appendix 2 on page 67 for a “Pressure vs Altitude” table.

From measurement mode:

1. Press the **MODE** key to select mg/l (ppm) mode.
2. Press the **SETUP** key to enter SETUP mode.
3. Press the **▲** and **▼** keys to scroll through subgroups until you view parameter P1.0 in the lower display.

See figure **A**

4. Press the **ENTER** key twice. The upper display shows either Hg or PA and the lower display shows bAr.

5. Press the **▲** and **▼** keys to toggle between mm Hg and Pascal units.

See figure **B**

6. Press the **ENTER** key to confirm selection and move to the next screen. The upper display shows the barometric pressure and the lower display shows the units selected in step 5.

See figure **C**

7. Press the **▲** and **▼** keys to adjust the barometric pressure. The pressure adjustment range is 500 to 1499 mm Hg (66.6 to 199.9 kPa).
8. Press the **ENTER** key to confirm selection and move to P1.2 on page 48 (salinity adjustment). If instead you want to return to measurement mode, press CAL/MEAS twice.

NOTE: Salinity adjustment appears in mg/l (ppm) measurement mode only.

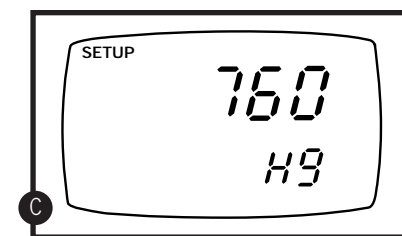
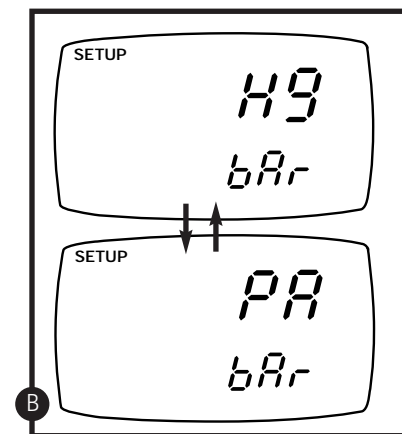
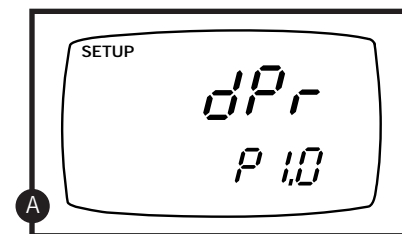



P1.2 Salinity adjustment mode

Salinity correction mode lets you correct for the variations in oxygen solubility due to salt concentration in the sample.

From measurement mode:

1. Press the **MODE** key to select mg/l (ppm) mode.
2. Press the **SETUP** key to enter SETUP mode.
3. Press the **▲** and **▼** keys to scroll through subgroups until you view parameter P1.0 in the lower display.

See figure **D**

4. Press the **ENTER** key five times. The upper display shows the salinity value and the lower shows SAL.

See figure **E**

5. Press the **▲** and **▼** keys to enter the correct salinity adjustment factor. The salinity adjustment factor range is 0.0 to 50.0 ppt.
6. Press the **ENTER** key to confirm selection and to move back to subgroup P1.0. If you want to return to measurement mode, press CAL/MEAS.

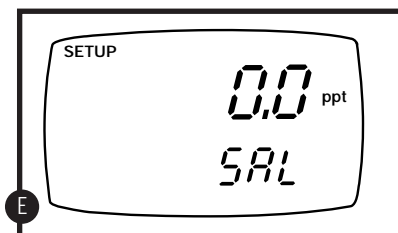
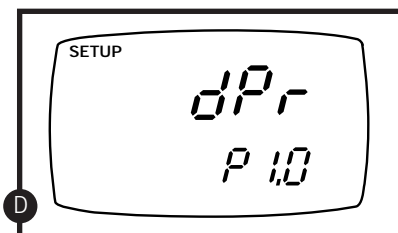

8.14 mg/l (ppm) mode—P2.0: Previous calibration information

This sub group shows you the previous calibration data, along with date and time of calibration. This is a “view only” parameter.

In mg/l (ppm) mode: calibration information is shown in mg/l (ppm) units.

From measurement mode:

1. Press the **MODE** key to select mg/l (ppm) mode.
2. Press the **SETUP** key to enter SETUP mode.
3. Press the **▲** and **▼** keys to scroll through subgroups until you view parameter P2.0 in the lower display.

See figure **A**

4. Press the **ENTER** key. The upper display shows the calibration data.

See figure **B**

6. Press the **ENTER** key to move back to subgroup P2.0. If you want to return to measurement mode, press CAL/MEAS.

NOTE: If you did not calibrate this meter in a particular mode, the screen will show “---”.

See figure **C**

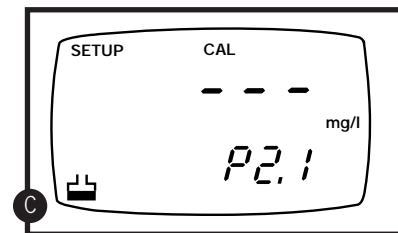
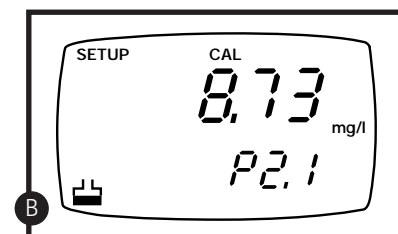
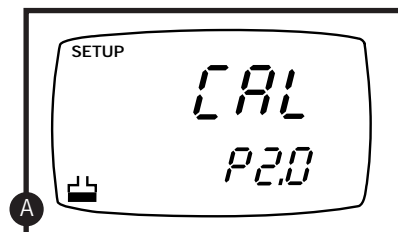

**8.15 mg/l (ppm) mode—P3.0: Electrode properties**

These “view only” parameters show the electrode properties for diagnostic purposes:

probe slope: shows the calibration slope of the probe. This mode displays slope from 0.5 to 1.999 % of slope (1.0 = 100%).

100% saturation mV value: shows the sensor’s mV output corresponding to 100% saturation.

0% saturation mV value: shows the sensor’s millivolt output corresponding to 0% saturation.

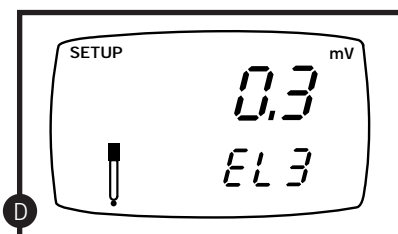
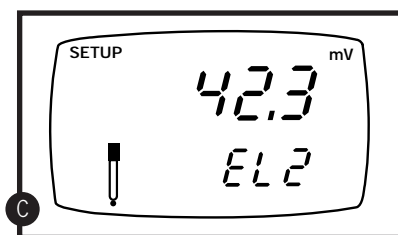
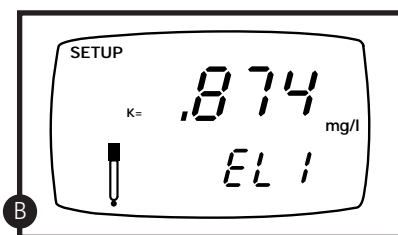
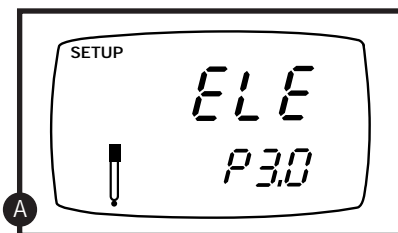

From measurement mode:

1. Press the **MODE** key to select the mg/l (ppm) measurement mode.
2. Press the **SETUP** key to enter SETUP mode.
3. Press the **▲** and **▼** keys to scroll through subgroups until you view parameter P3.0 in the lower display.

See figure **A**

4. Press the **ENTER** key. The upper display shows the probe slope.

See figure **B**

6. Press the **ENTER** key. The upper display shows the 100 % saturation mV value.

See figure **C**

7. Press the **ENTER** key. The upper display shows the 0 % saturation mV value.

See figure **D**

8. Press the **ENTER** key to move back to subgroup P3.0. If you want to return to measurement mode, press CAL/MEAS.

8.16 mg/l (ppm) mode—P4.0: Unit configuration

Unit configuration mode lets you select the following parameters:

- A. Ready indicator and auto endpoint function
- B. mg/l or ppm units
- C. Temperature in °C or °F

P4.1: READY indicator and auto endpoint function

The first program lets you select:

- “**READY indicator on**” to indicate when the reading is stable.
- “**READY indicator off**” for faster meter response.
- **Auto endpoint function on.** Select auto endpoint on to “hold” the reading when it is stable for more than 5 seconds. The display automatically freezes, and the HOLD indicator appears on the left side of the display. Press the HOLD key to release the display and access other functions.

From measurement mode:

1. Press the **MODE** key to select the mg/l (ppm) measurement mode.
2. Press **SETUP** key to enter SETUP mode.
3. Press the **▲** and **▼** keys to scroll through subgroups until you view parameter P4.0 in the lower display.

See figure **A**

4. Press the **ENTER** key to select parameter P4.0 “rdy” (Ready).

See figure **B**

5. Press the **▲** and **▼** keys to select the configuration you require.
 - ON switches the READY indicator on.
 - OFF switches the READY indicator off.
 - ON and HOLD together switches the auto endpoint feature on.
6. Press the **ENTER** key to confirm selection and to proceed to P4.2 on page 52. Or, press the CAL/MEAS key twice to return to measurement mode.

Notes: Meter default is set for Ready indicator on, and auto endpoint function off.

You can also change the Ready indicator and auto endpoint function in SETUP Program P3.1 on page 35 in pH mode or P5.1 on page 43 in % saturation mode. Any changes you make to the Ready indicator/ auto endpoint function in % saturation mode will also change in pH and % saturation modes.

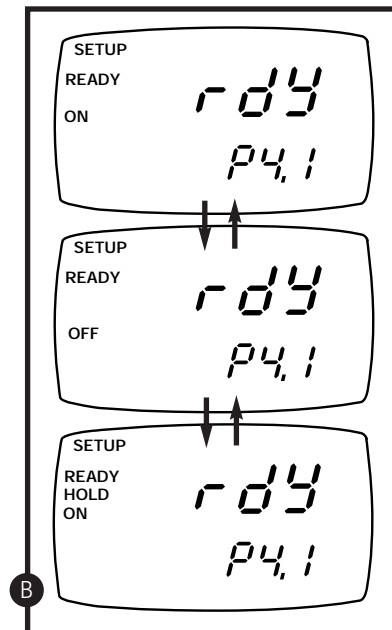
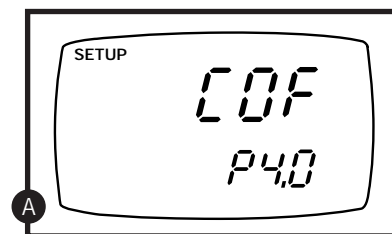

P4.2: Selecting mg/l or ppm units

This mode lets you select between mg/l or ppm dissolved oxygen units.

From measurement mode:

1. Press the **MODE** key to select mg/l (ppm) mode.
2. Press **SETUP** key to enter SETUP mode.
3. Press the **▲** and **▼** keys to scroll through subgroups until you view parameter P4.0 in the lower display.

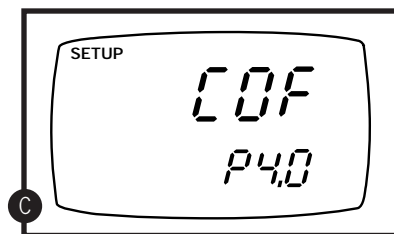

See figure **C**

4. Press the **ENTER** key until “dO” appears in the upper display, P4.2 in the lower display.

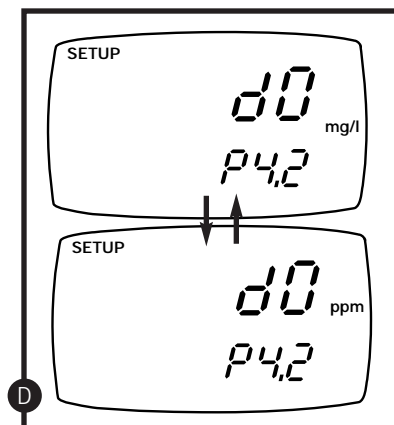

See figure **D**

5. Press the **▲** and **▼** keys to toggle between mg/l or ppm units.
6. Press the **ENTER** key to confirm selection and move to P4.3 on page 53. Press the **CAL/MEAS** key twice to return to measurement mode.

P4.3: Selecting °C or °F temperature readout

This meter lets you select between °C and °F units for temperature readings.

From measurement mode:

1. Press the **MODE** key to select mg/l (ppm) mode.
2. Press **SETUP** key to enter SETUP mode.
3. Press the **▲** and **▼** keys to scroll through subgroups until you view parameter P4.0 in the lower display.

See figure **E**

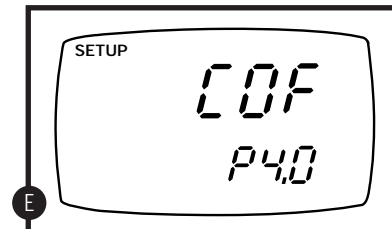

4. Press the **ENTER** key until “C” or “F” appears in the upper display.

See figure **F**

5. Press the **▲** and **▼** keys to toggle between °C and °F.
6. Press the **ENTER** key to confirm selection and to return to the subgroup menu. Press the **CAL/MEAS** key to return to measurement mode.

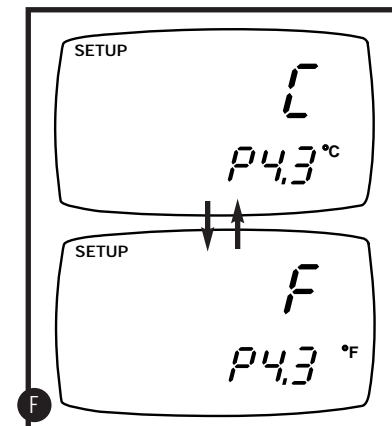

NOTES:

You can also switch between °C and °F in SETUP Program P3.3 on page 37 in pH mode or Program P5.2 on page 44 in mg/l (ppm) mode. If you switch between °C and °F in mg/l (ppm) mode, the meter will also switch in pH and % saturation modes.



8.17 mg/l (ppm) mode—P5.0: Adjusting LCD brightness

This mode lets you adjust the brightness of the backlit LCD. Selecting a dimmer backlighting level helps conserve batteries.

From measurement mode:

1. Press the **MODE** key to select mg/l (ppm) mode.
2. Press **SETUP** key to enter SETUP mode.
3. Press the **▲** and **▼** keys to scroll through subgroups until you view parameter P5.0 in the lower display.

See figure **A**

4. Press the **ENTER** key. A number (0-8) appears in the upper display and “LCD” appears in the lower display.

See figure **B**

6. Press the **▲** and **▼** keys to select from level 0 (dimmiest light) to level 8 (brightest light).
6. Press the **ENTER** key to confirm selection and to return to the subgroup menu. Press the **CAL/MEAS** key to return to measurement mode.

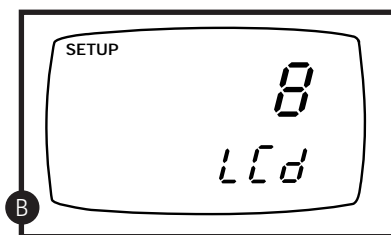
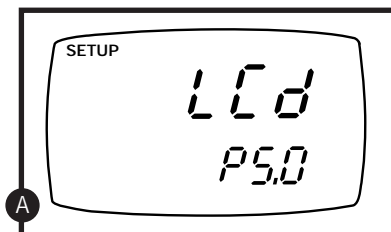

8.18 mg/l (ppm) mode—P6.0: Resetting to factory default settings

This program lets you reset all parameters to factory default settings. This clears all calibration data, memory, and any other setup functions you might have changed. The LCD contrast setting will be reset to 8 (the maximum setting). However, the following settings will remain as you have set them:

- temperature unit of measure (°C or °F)
- the temperature offset calibration value
- pH calibration data and set parameters

From measurement mode:

1. Press the **MODE** key to select mg/l (ppm) mode.
2. Press **SETUP** key to enter SETUP mode.
3. Press the **▲** and **▼** keys to scroll through subgroups until you view parameter P6.0 in the lower display.

See figure **A**

4. Press the **ENTER** key.

See figure **B**

5. Press the **▲** and **▼** keys to toggle between NO and YES.
 - NO retains current settings
 - YES resets to factory default settings
6. Press the **ENTER** key to confirm selection and to return to measurement mode.

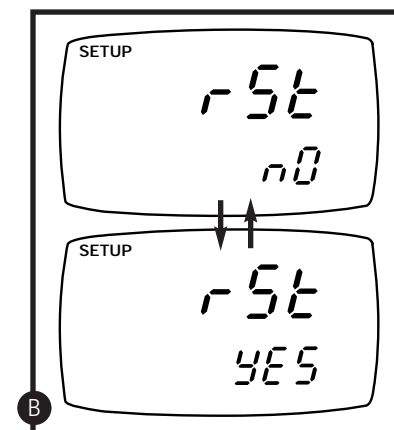
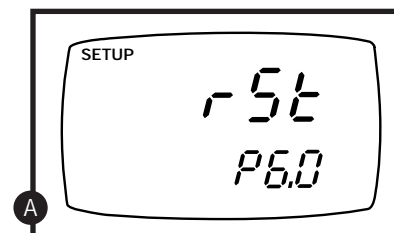

NOTES:

To reset all pH data, see page 38.

To reset all % saturation data, see page 46.

See page 68 for a table of factory default settings.

9. Probe Care and Maintenance

9.1 pH Electrode Care

Since your pH electrode is susceptible to dirt and contamination, clean it every one to three months depending on the extent and condition of use.

NOTE: for specialty electrode care, consult the instruction manual included with your electrode.

pH electrode storage

For best results, always keep the pH bulb wet. Use the rubber cap filled with OAKTON electrode storage solution to store your electrode (see page 64-65 for ordering information). Also, you can store in a pH 4 buffer with 1/100 part of saturated KCl. Other pH buffers are OK for storage, but NEVER use distilled water for storage.

After measuring

1. Rinse the pH electrode and reference junction in de-ionized water.
2. **Store the electrode as recommended above in “pH electrode storage,” or as recommended by the manufacturer.**
3. Prior to next use, rinse the liquid junction with de-ionized water and tap dry—**never wipe electrode.**

NOTE: If this does not restore electrode to normal response, see “Reactivating the pH electrode” section on page 57.

pH electrode cleaning

Salt deposits: dissolve the deposits by immersing the electrode in tap water for ten to fifteen minutes. Ten thoroughly rinse with distilled water.

Oil/grease film: wash electrode pH bulb gently in some detergent and water. Rinse electrode tip with distilled water or use a general purpose electrode cleaner (see page 65 for ordering information).

Clogged reference junction: heat a diluted KCl solution to 60 to 80°C. Place the sensing part of the electrode into the heated solution for about 10 minutes. Allow the electrode to cool in some unheated KCl solution.

Protein deposits: prepare a 1% pepsin solution in 0.1 M of HCl. Set the electrode in the solution for five to ten minutes. Rinse the electrode with distilled water.

Reactivating the pH electrode

If stored and cleaned properly, your pH electrode should be ready for immediate use. However, a dehydrated bulb may cause sluggish response. To rehydrate the bulb, immerse the electrode in a pH 4 buffer solution for 10 to 30 minutes. If this fails, you probably need to replace the pH electrode. **Never touch or rub glass bulb. Contact builds up an electrostatic charge.**

9.2 DO Probe Care

The probe is a galvanic measuring element which produces an output proportional to the oxygen present in the medium in which it is placed. The galvanic probe design lets you take measurements immediately—without the typical 15 minute wait of other dissolved oxygen probes.

The probe consists of two parts:

- an upper part consisting of an anode, a cathode, and cable
- a lower part consisting of a membrane cap, membrane, and electrolyte solution.

Under typical operating conditions, the probe should last for several years. Proper care and maintenance will help you receive the maximum probe life and ensure more accurate readings.

Since any deposits on the membrane surface act as a barrier to oxygen diffusing through the membrane, the membrane must be cleaned at regular intervals to assure maximum reliability.

After using the probe, rinse the probe in clean water and wipe it with a soft cloth or paper to avoid any hardening of deposits. If growth develops on the probe, use a disinfecting chemical to clean.

NOTE: Although the membrane is strong and not easily damaged, wipe it gently while cleaning it. If the membrane is damaged or torn, the probe will no longer function.

There are no special probe storage requirements.

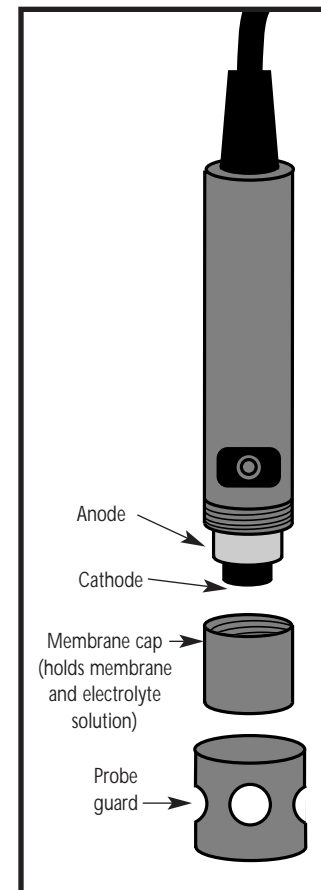

9.3 DO Membrane Replacement

Replacement of the membrane is required only when you cannot calibrate the probe, or if the membrane is damaged.

Typical membrane damages are punctures or wrinkles caused during measurements or cleaning.

To order replacement probe components or a replacement probe, see the "Accessories" section on page 64.

To replace the probe membrane:

1. Pull off the probe guard.
2. Unscrew the membrane cap from the probe.
3. Hold the probe under a water tap and brush away the white oxide on the cylindrical anode with a stiff plastic brush—do not use metal cleaning material.
4. If the cathode has any deposits, remove them with a light scouring powder. Do not polish the cathode.

NOTE: If you have purchased a replacement membrane module with preinstalled membrane, skip to step 12.

CONTINUED ON NEXT PAGE

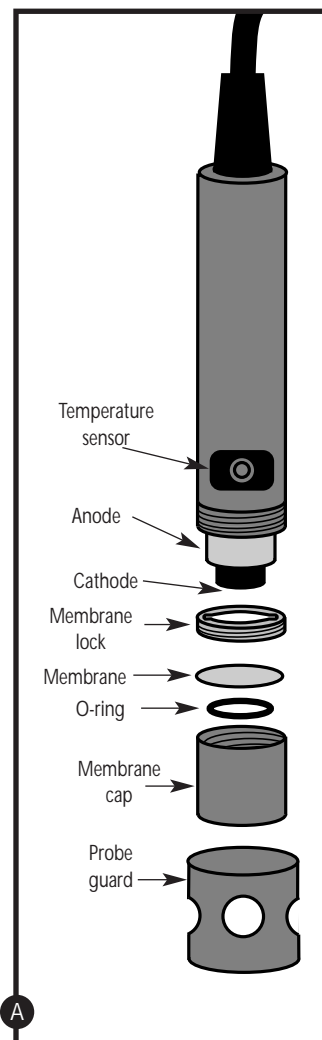

5. Using the installation tool, unscrew and remove the membrane lock from the membrane cap.

See figure **B**

6. Remove the membrane and O-ring. Discard both.
7. Rinse the membrane cap and membrane lock in tap water.
8. Install a new O-ring inside the membrane cap.
9. Install a new membrane. Make sure the membrane covers the O-ring all around its circumference.

See figure **C**

10. Using the installation tool, screw the membrane lock back into the cap. Tighten the lock firmly over the membrane and O-ring, but do not overtighten.
11. Inspect the membrane for wrinkles. If wrinkles exist, remove the membrane and repeat steps 8-11.
12. Fill the membrane cap with water and inspect the bottom for leaks. If water drops are leaking from the membrane, re-seat the membrane on the O-ring (repeat steps 8-11).
13. If the assembly is leak-free, empty the water and fill the membrane cap with electrolyte to the brim.
14. Screw the cap onto the probe. Excess electrolyte will drain out.
15. Replace probe guard.
16. Calibrate the probe (see section 4.4-4.6 on pages 14-18) after the % saturation readings have stabilized.

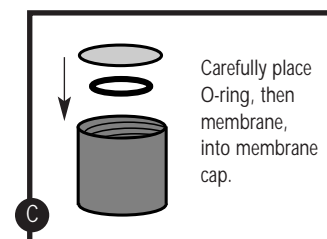
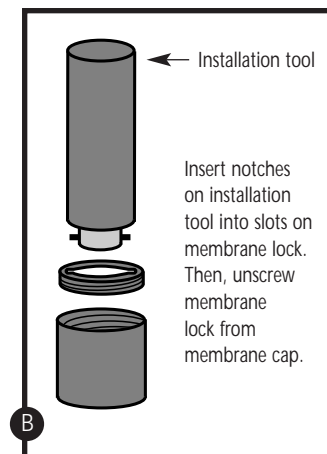



9.4 DO Electrolyte solution

The electrolyte solution in your probe's cap will periodically evaporate and need to be replaced. 35640-71 replacement electrolyte solution comes premixed and ready to use. However, the electrolyte mixture package 35640-70 has a longer shelf life in its unmixed form.

If you purchase the electrolyte mixture package to make your own replacement electrolyte solution, use the following steps to prepare the solution:

1. Fill a beaker to the 400 ml mark with deionized water.
2. Pour the entire contents of the 58.5 grams electrolyte package into the beaker.
3. Stir the solution until all of the chemical is dissolved—until the solution is clear.
4. Pour the solution into a clean container with a cap and keep sealed between use.

10. Troubleshooting

Problem	Cause	Solution
Power on but no display	<ul style="list-style-type: none"> a) Batteries not in place. b) Batteries not in correct polarity (+ and -). c) Weak batteries. 	<ul style="list-style-type: none"> a) Check that batteries are in place and making good contact. b) Reinsert batteries with correct polarity. c) Replace batteries.
Unstable readings	<ul style="list-style-type: none"> a) Insufficient electrolyte in DO probe. b) Air bubbles in probe. c) Dirty DO probe or pH electrode. d) Probe not deep enough in sample. e) External noise pickup or induction caused by nearby electric motor. f) Broken DO probe or pH electrode 	<ul style="list-style-type: none"> a) Fill DO probe with reference electrolyte. See page 58-59. b) Tap probe to remove bubbles. c) Clean the probe or electrode and recalibrate. d) Make sure sample entirely covers the probe sensors. e) Move or switch off interfering motor. f) Replace probe or electrode. See page 64.
Slow response	<ul style="list-style-type: none"> a) Dirty membrane/ Dirty electrode 	<ul style="list-style-type: none"> a) Clean probe. See "Probe Care & Maintenance", page 56-59.
Not responding to key press	<ul style="list-style-type: none"> a) HOLD mode in operation. b) Damaged key pad. c) Internal program error. 	<ul style="list-style-type: none"> a) Cancel HOLD mode. b) Return to dealer. c) Reset all internal programs by reinserting batteries.



11. Error Messages

LCD Display	Indicates	Cause	Solution
Err annunciator	Unrecognized input from keypad	Wrong input in selected mode.	Release key. Select valid operations depending on mode.
CAL & Err annunciators blink	Calibration error	Wrong value input at calibration. Dirty probe.	Check your input value, clean probe. See Calibration sections or Probe Maintenance section.
Battery indicator blinks	Low battery level	Need new batteries or battery connection is bad.	Clean battery contacts. Replace batteries with fresh ones, noting polarity.

* See "Warranty" and "Return of Items" on page 67

If an error message appears in the primary display (the upper row of larger digits), switching off the meter and switching it on again may eliminate the error message.

If error persists, or the meter shows incorrect values, return the meter.

For a complete diagram of the display, see page 5.

12. Specifications

Mode	pH	mg/l (ppm)	% saturation	Temperature
Range	-2 to 16 pH	0.00 to 20.00 mg/l (ppm)	0.0 to 200.0%	0.0 to 50.0°C / 32.0 to 122.0°F
Resolution	0.01 pH	0.01 mg/l (ppm)	0.1%	0.1°C / 0.1°F
Accuracy	±0.01 pH	±1.5% full scale	±1.5% full scale	±0.3°C / ±0.5°F
Calibration	up to 5 points: pH 1.68; 4.01; 7.00; 10.01; 12.45	one or two points (100% and 0% saturation); plus separate mg/l (ppm) slope		offset up to ±5°C or ±10°F

Temperature compensation: automatic from 0 to 50°C

Salinity correction:

Range: 0.0 to 50.0 ppt

Resolution: 0.1 ppt

Method: Key in manually and automatic correction

Barometric pressure correction:

Range: 500 to 1499 mm Hg / 66.6 to 199.9 kPa

Resolution: 1 mm Hg / 0.1 kPa

Method: Key in manually and automatic correction

DO Probe type: galvanic probe

Display: dual LCD

Backlit display: select from eight levels of brightness

Operating temperature: 0 to 50°C

Power: four 1.5 V AAA batteries (included)

Battery life: > 100 hours continuous use

use of backlit display decreases battery life

Dimensions:

Meter: 7.5"L x 3.75"W x 2.25"H (19 x 9.5 x 5.7 cm)

Boxed: 9.2"L x 9.2"W x 2.75"H (23 x 23 x 7 cm)

DO Probe: 6.8"L x 1.3" dia (173 mm L x 32 mm dia) with 10-ft cable

pH Electrode: 6.0"L x 1.0" dia (152 mm L x 25 mm dia) with 10-ft cable

Weight:

Meter: 1.0 lb (0.5 kg)

Boxed: 2.0 lbs (0.9 kg)



13. Accessories

Meters

35632-02 pH/DO 300 meter Meter only

35632-00 pH/DO 300 meter Includes DO probe with 10-ft cable (35640-50), pH electrode with 10-ft cable (35805-23), and electrolyte solution

35632-60 pH/DO meter kit. Includes pH/DO meter plus DO probe with 10-ft cable, pH electrode with 10-ft cable, 20 pH "Singles" pouches, 500 ml of electrolyte solution, 5 replacement membranes, membrane replacement tool, rinse bottle and foam-lined hard carrying case.

Probes and probe replacement parts

35640-50 Replacement DO probe with 10-ft cable

35640-52 DO probe with 25-ft cable

35805-23 Replacement submersible pH electrode with 10-ft cable, single junction, ABS plastic housing

35640-71 Replacement DO electrolyte solution, 500 ml

35640-70 Electrolyte DO powder, 58.5 g. Mix your own electrolyte solution—makes 400 ml. Has longer shelf life in unmixed form.

WD-35640-72 Replacement DO membrane module. This item consists of a preassembled membrane, membrane lock, O-ring and cap. Simply screw replacement membrane module onto the probe you already have.

35640-74 Replacement DO membranes, 5/pack

35640-75 Replacement DO membranes, 25/pack

35640-79 DO membrane installation tool. Required for membrane installation. Not required if you purchase replacement membrane module 35640-72.

OAKTON calibration solutions

pH solutions have ± 0.01 pH accuracy at 25°C. Shpg wt 1.1 lb (510 g).

00654-01 pH 1.68 calibration buffer, 1 pint.

00654-00 pH 4.01 calibration buffer, 1 pint.

00654-04 pH 7.01 calibration buffer, 1 pint.

00654-08 pH 10.01 calibration buffer, 1 pint.

00654-12 pH 12.45 calibration buffer, 1 pint.

OAKTON "Singles" calibration solution pouches

pH solutions have ± 0.01 pH accuracy at 25°C. Shpg wt 1.1 lb (510 g) per box.

35653-00 Deionized rinse water solution pouches, 20/box.

35653-01 pH 4.01 calibration buffer solution pouches, 20/box.

35653-02 pH 7.00 Calibration buffer solution pouches, 20/box.

35653-03 pH 10.00 Calibration buffer solution pouches, 20/box.

35653-04 Assortment pack, 5 each deionized water, pH 4.01, pH 7.00, and pH 10.00 solution pouches.

Other accessories

00653-04 pH electrode storage solution, 1 pint

00653-06 pH electrode cleaning solution, 1 pint

00653-00 Zero oxygen solution

04804-00 Battery-powered magnetic stirrer

To order OAKTON accessories, contact your OAKTON distributor.



14. Appendix 1: Meter Theory

Dissolved oxygen levels in natural and waste waters depend on the physical, chemical, and biochemical activities in the water body.

This meter uses a galvanic probe. It consists of a cell that contains electrolyte and that is enclosed by a selective membrane, and two metallic electrodes. The membrane is practically impermeable to water and ionic dissolved matter, but is permeable to oxygen and a few other gases.

The cathode consumes the oxygen passed through the membrane, and produces an electric current in the probe. This current is proportional to the partial pressure of oxygen in the sample.

Since the cathode consumes the oxygen in the sample, it is essential that the fluid must flow past the sensor to maintain accurate readings.

The solubility of oxygen in water varies with barometric pressure and temperature, and decreases as salinity increases. For the most accurate DO readings, you need to compensate for these factors. This meter automatically compensates for temperature readings. It also allows you to enter a salinity correction factor and the barometric pressure to correct for this variability.

15. Appendix 2: Pressure vs. Altitude table

Barometric pressure affects DO readings, therefore this meter lets you enter the correct barometric pressure at your altitude. If you do not have equipment that lets you measure the exact barometric pressure at your altitude, you can estimate it using the chart below.

If you change the barometric pressure setting from its factory setting (760 mm Hg), the % saturation calibration value in air will automatically adjust to a value other than 100% (see "corrected % saturation value" column below). The adjusted value is correct for the new barometric pressure setting.

See page 39 or 47 for information on how to adjust the barometric pressure.

Pressure vs Altitude

Altitude (ft)	Pressure (mm Hg)	Corrected % saturation value
0 (Sea level)	760	100
500	746	98.1
1000	732	96.3
1500	720	94.7
2000	707	93.0
2500	694	91.3
3000	681	89.6
3500	668	87.8
4000	656	86.2
4500	644	84.6
5000	632	83.0
5500	621	81.6
6000	609	80.0

16. Appendix 3: Factory Default Settings

Resetting the meter to factory default settings clears all calibration data and returns other setup functions to the default settings shown in the table below. However, the following settings will remain as you have set them:

- temperature unit of measure (°C or °F)
- The temperature offset calibration value
- the LCD contrast setting

See pages 38, 46 and 55 for directions on setting all modes of this meter to factory default settings.

Program	Function	Options/settings	Default
Clr	Memory clear	yes/no	no
dPr	Pressure units Barometric pressure Salinity adjustment	Hg or Pa adjust from 500-1499 mm Hg adjust from 0-50 ppt	Hg 760 mm Hg 0 ppt
OFS	Set % saturation offset	up to ±10%	no offset
CAL	View calibration data	—	— — —
ELE	View pH electrode offset View pH electrode slope View DO probe slope View % saturation offset View mV value of DO probe @ 100% saturation View mV value of DO probe @ 0% saturation	— — — — — — —	0.00 mV 100.0% 1.000 0 % offset 37.0 mV 0.3 mV
COF	Ready indicator/auto endpoint Select mg/l or ppm units Select temperature units	on/off mg/l or ppm °C or °F	Ready on only mg/l retains settings
LCd	Adjust backlit display	levels 0 to 8 (brightest)	8
rST	Reset to factory default	yes/no	no

17. Warranty

OAKTON warrants this meter to be free from significant deviations in material and workmanship for a period of three years from date of purchase. OAKTON warrants this probe to be free from significant deviations in material and workmanship for a period of six months from date of purchase. If repair or adjustment is necessary and has not been the result of abuse or misuse within the warranted time period, please return—freight prepaid—and correction will be made without charge. OAKTON alone will determine if the product problem is due to deviations or customer misuse.

Out-of-warranty products will be repaired on a charge basis.

18. Return of items

Authorization must be obtained from our Customer Service Department before returning items for any reason. When applying for authorization, please include data regarding the reason the items are to be returned. For your protection, items must be carefully packed to prevent damage in shipment and insured against possible damage or loss. We will not be responsible for damage resulting from careless or insufficient packing. A restocking charge will be made on all unauthorized returns.

NOTE: We reserve the right to make improvements in design, construction, and appearance of products without notice.

