

# Integrated Instruction Manual WP 600 Series Meters

pH 600 / 610 / 620, COND 600 / 610, DO 600,  
PC 650, PD 650, CD 650, PCD 650

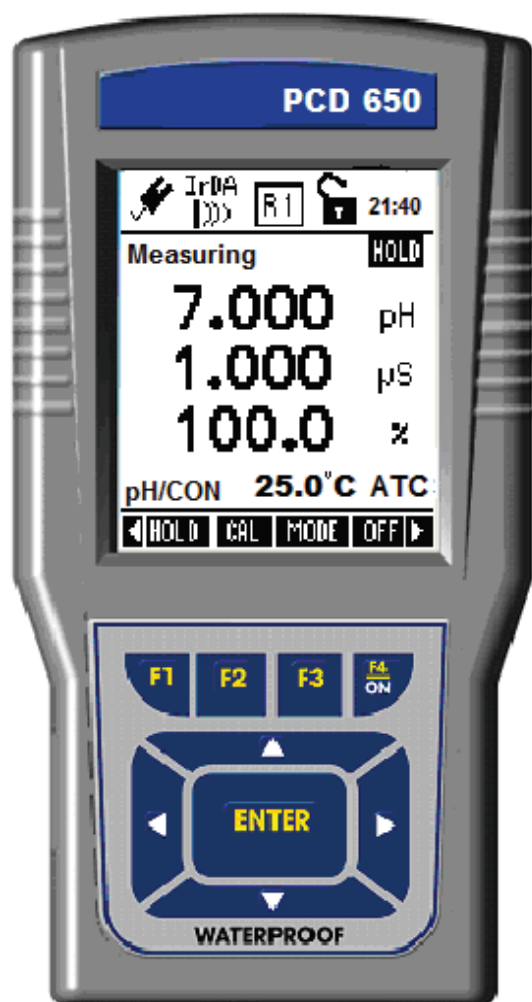

**OAKTON**

Part of Thermo Fisher Scientific

**EUTECH**  
INSTRUMENTS

*Technology Made Easy...*

**ISO 9001**  
CERTIFIED

68X415307 Rev. 4 June 2010

**\*IMPORTANT – PLEASE READ BEFORE YOU CONTINUE\***

**PLEASE USE THIS MANUAL IN THIS ORDER :**

**Step 1:**

Use the first half of this manual “General Guide” and “Temperature” to set up and calibrate your instrument (Pages 1 - 39).

**Step 2:**

Then go to the specific parameter guides (eg. pH, Conductivity, TDS etc) which are relevant to the model you have purchased. (Pg 41 onwards).

**CAUTION:** Do not skip the general guide as your meter will not be configured to read accurately if your set-up and calibrations are not done accordingly.

Thank you for reading this page. Please proceed.

# Table of Contents

---

<b>GENERAL GUIDE.....</b>	<b>1</b>
<b>1. Overview For All Meters .....</b>	<b>3</b>
1.1 About the Meters.....	3
1.1.1 Display Overview.....	3
1.1.2 Key Functions.....	3
1.2 Inserting Batteries .....	4
1.2.1 Inserting batteries for the first time.....	4
1.2.2 Changing batteries subsequently.....	4
1.3 Attaching the Belt.....	5
1.4 Connecting Peripherals.....	6
1.4.1 Probes (pH/Conductivity/DO).....	6
1.4.2 Protective Rubber Boot.....	7
<b>2. System Setup Mode For All Meters .....</b>	<b>8</b>
2.1 About Setup Mode .....	8
2.2 Accessing Setup mode .....	8
2.3 Setup Selection: System Settings.....	9
2.4 Accessing Setup mode when password protection enabled .....	15
2.5 Modifying Setup parameters.....	16
<b>3. Calibration Mode For All Meters .....</b>	<b>17</b>
3.1 About Calibration.....	17
3.2 About Conductivity/ Resistivity/ TDS/ Salinity Calibration.....	17
3.3 Preparing the Meter for Calibration.....	17
3.4 Accessing Calibration mode.....	19
3.4.1 Accessing Calibration mode when password protection enabled.....	19
<b>4. Measurement Mode For All Meters.....</b>	<b>21</b>
4.1 About Measurement Mode.....	21
4.1.1 Accessing functions.....	21
4.2 Taking Measurements.....	22
4.2.1 Prepare the meter for measurement.....	22
4.2.2 Taking a reading.....	22
4.2.3 Stable reading indicator .....	23
4.2.4 Holding a reading .....	23
4.3 Automatic Temperature Compensation (ATC).....	23
4.3.1 Manual Temperature Compensation (MTC) .....	23
4.4 Alarm set point (For pH/conductivity/DO) .....	24
4.5 Calibration Due (CAL-DUE) Indicator (For pH/conductivity/DO) .....	24
<b>5. TRANSFERRING AND PRINTING DATA.....</b>	<b>24</b>
5.1 CyberComm 600 Data Acquisition Software.....	24
5.2 Working with Memory functions – Auto Data Logging .....	24
5.2.1 Logging data automatically in the meter’s memory.....	25
5.2.2 Storing a current measurement (In IrDA and LED print mode: Applicable to all modes) ....	25
5.2.3 Viewing stored data.....	25
5.2.4 Transferring stored data to the Computer (CyberComm) through IrDA.....	26
5.2.5 Transferring stored data to a PC not equipped with infrared receiver. ....	27
5.2.6 Transferring stored data to a PC using an USB/ irDA Dongle.....	28
<b>6. Technical Specifications .....</b>	<b>29</b>
<b>7. Accessories .....</b>	<b>33</b>
<b>8. Warranty &amp; Return Policy.....</b>	<b>34</b>
8.1 Warranty .....	34
8.2 Return of Goods.....	34
8.3 Guidelines for Returning Unit for Repair .....	35

<b>TEMPERATURE .....</b>	<b>36</b>
<b>1. Temperature Setup .....</b>	<b>38</b>
<b>2. Temperature Calibration.....</b>	<b>38</b>
2.1 About Temperature Calibration.....	38
2.2 Temperature Calibration for ATC mode.....	39
2.3 Temperature Calibration for MTC mode .....	40
<b>3. Temperature Measurement .....</b>	<b>40</b>
<b>pH.....</b>	<b>42</b>
<b>1. pH Setup .....</b>	<b>44</b>
<b>2. pH Calibration.....</b>	<b>45</b>
2.1 About pH Calibration.....	45
2.2 pH buffer group for calibration and auto-recognition .....	46
2.2.1 pH Calibration points.....	46
2.3 pH Calibration with a Standard Buffer.....	46
2.3.1 To start pH Calibration: .....	46
2.4 pH Calibration with a User-defined Buffer.....	48
2.5 Calibration Report .....	49
2.5.1 To View Calibration Report: .....	49
2.6 Average Slope Indicator of pH Probe .....	50
<b>3. pH Measurement Mode.....</b>	<b>50</b>
3.1 Resolution of pH Reading .....	50
3.2 Indicators in pH measurement screen .....	51
<b>mV .....</b>	<b>52</b>
<b>1. mV Setup Mode .....</b>	<b>54</b>
<b>2. mV Calibration Mode .....</b>	<b>54</b>
2.1 mV Calibration with a Standard ORP Calibration Solution .....	54
2.2 Calibration Report .....	55
2.2.1 To View Calibration Report: .....	55
<b>3. mV Measurement Mode .....</b>	<b>55</b>
3.1 Indicators in mV measurement mode .....	55
<b>ION .....</b>	<b>58</b>
<b>1. Ion Setup.....</b>	<b>60</b>
<b>2. Ion Calibration Mode.....</b>	<b>60</b>
2.1 About Ion Calibration.....	60
2.2 Calibration Report .....	62
2.2.1 To View Calibration Report .....	62
<b>3. Ion Measurement Mode .....</b>	<b>63</b>
3.1 Changing unit of measurement.....	63
3.2 Indicators in Ion measurement mode.....	63
<b>CONDUCTIVITY.....</b>	<b>64</b>
<b>1. Conductivity Setup .....</b>	<b>66</b>
<b>2. Conductivity Calibration Mode .....</b>	<b>68</b>
2.1 Conductivity Calibration mode .....	68
2.1.1 Conductivity calibration points.....	68
2.2 Cell constant 68	
2.3 Normalization Temperature (°C).....	68
2.4 Linear temperature Coefficient.....	68
2.5 Pure Water Coefficient .....	69
2.6 To begin Calibration .....	69
2.7 Manual Calibration .....	70
2.8 Automatic Calibration (For Conductivity Calibration) .....	70

2.9 Calibration Report .....	72
2.9.1 To View Calibration Report: .....	72
<b>3. Conductivity Measurement Mode .....</b>	<b>72</b>
3.1 Indicators in Conductivity measurement screen .....	72
<b>TDS .....</b>	<b>75</b>
<b>1. TDS Setup .....</b>	<b>77</b>
<b>2. TDS Calibration Mode .....</b>	<b>79</b>
2.1 TDS Calibration Report .....	80
2.1.1 To View Calibration Report: .....	80
<b>3. TDS Measurement Mode .....</b>	<b>81</b>
3.1 Indicators in TDS measurement mode .....	81
<b>4. About TDS .....</b>	<b>82</b>
4.1 Calculating TDS Conversion Factor .....	82
4.2 Calculating Temperature Coefficients .....	82
<b>SALINITY .....</b>	<b>83</b>
<b>1. Salinity Setup .....</b>	<b>85</b>
<b>2. Salinity Calibration Mode .....</b>	<b>86</b>
2.1 Salinity Calibration Report .....	88
2.1.1 To View salinity Report: .....	88
<b>3. Salinity Measurement Mode .....</b>	<b>89</b>
3.1 Indicators in salinity measurement mode .....	89
<b>RESISTIVITY .....</b>	<b>91</b>
<b>1. Resistivity Setup .....</b>	<b>93</b>
<b>2. Resistivity Calibration Mode .....</b>	<b>95</b>
2.1 Resistivity Calibration Report .....	96
2.1.1 To View Calibration Report: .....	96
<b>3. Resistivity Measurement Mode .....</b>	<b>97</b>
3.1 Indicators in Resistivity measurement mode .....	97
<b>DISSOLVED OXYGEN .....</b>	<b>99</b>
<b>PART A - % Saturation Mode .....</b>	<b>101</b>
<b>1. O2 % - DO Saturation Setup .....</b>	<b>101</b>
<b>2. DO Calibration in % Saturation Mode (with ATC) .....</b>	<b>103</b>
2.1 About DO(%) and DO (mg/L) Calibration .....	103
2.2 To calibrate 100% saturation .....	103
2.3 To calibrate 0% saturation .....	105
2.3.1 % DO Calibration Report .....	106
2.3.2 To View Calibration Report: .....	106
2.4 % Saturation Offset Adjustment .....	107
2.5 Set barometer pressure range and barometric pressure units .....	107
2.6 Pressure compensation .....	107
<b>3. Percentage Saturation (%) Measurement Mode .....</b>	<b>107</b>
3.1 Indicators in percentage saturation measurement mode .....	107
<b>PART B – Concentration (mg/L) (ppm) Mode .....</b>	<b>108</b>
<b>1. O2 mg/L (ppm) – DO Concentration Setup .....</b>	<b>108</b>
<b>2. DO Calibration in mg/L mode or ppm Concentration mode .....</b>	<b>111</b>
2.1 Concentration Calibration Report .....	112
2.1.1 To View Calibration Report: .....	112
2.2 Set Salinity .....	113

2.2.1 Auto Salinity Compensation .....	113
<b>3. Concentration in Measurement Mode .....</b>	<b>113</b>
3.1 Indicators in concentration measurement screen .....	113
3.2 Dissolved Oxygen Probe.....	114
3.2.1 Dissolved Oxygen Principle .....	114
3.2.2 Probe Care .....	115
3.2.3 Membrane Housing Replacement.....	115
3.2.4 Membrane/O-ring Replacement (Optional Procedure) .....	116
3.2.5 Electrolyte Solution.....	117



# GENERAL GUIDE

**This section is applicable to all models of the WP 600 Series Meters. Please do not skip this section.**

<b><u>Model</u></b>	<b><u>Parameters</u></b>
<b>pH 600</b>	<b>Temperature</b> (with ATC), <b>pH</b> (-2.00 to 20.00 measuring range).
<b>pH 610</b>	<b>Temperature</b> (with ATC), <b>pH</b> (expandable resolution to 0.001).
<b>pH 620</b>	<b>Temperature</b> (with ATC), <b>pH</b> (expandable resolution to 0.001) and <b>Ion</b> .
<b>COND 600</b>	<b>Temperature</b> (with ATC), <b>Conductivity</b> , <b>TDS</b> .
<b>COND 610</b>	<b>Temperature</b> (with ATC), <b>Conductivity</b> , <b>TDS</b> , <b>Salinity</b> , <b>Resistivity</b> .
<b>DO 600</b>	<b>Temperature</b> (with ATC), <b>Dissolved Oxygen</b> (% & ppm).
<b>PC 650</b>	<b>Temperature</b> (with ATC), <b>pH</b> , <b>mV</b> , <b>Ion</b> , <b>Conductivity</b> , <b>TDS</b> , <b>Salinity</b> , <b>Resistivity</b> .
<b>PD 650</b>	<b>Temperature</b> (with ATC), <b>pH</b> , <b>mV</b> , <b>Ion</b> , <b>Dissolved Oxygen</b> (% & ppm).
<b>CD 650</b>	<b>Temperature</b> (with ATC), <b>Conductivity</b> , <b>TDS</b> , <b>Salinity</b> , <b>Resistivity</b> , <b>Dissolved Oxygen</b> (% & ppm).
<b>PCD 650</b>	<b>Temperature</b> (with ATC), <b>pH</b> , <b>mV</b> , <b>Ion</b> , <b>Conductivity</b> , <b>TDS</b> , <b>Salinity</b> , <b>Resistivity</b> , <b>Dissolved Oxygen</b> (% & ppm).

# 1. Overview For All Meters











## 1.1 About the Meters

### SPECIAL FEATURES





- Displays and measures up to 4 parameters simultaneously
- Automatic temperature compensation
- Built in memory backup to save calibration and 500 sets of measured data
- Data logging feature date-and-time stamp to meet Good Laboratory Practice (GLP)
- Data transmission through IrDA or RS232 through LED
- User-selectable 'CAL-DUE' and set point alarm functions
- Power source and Battery level indicator
- Designed to work either from mains power or battery and automatically detect and switch to mains if available
- Waterproof casing
- User-configurable password protection for calibration & setup data
- Intuitive on-screen messages appear to assist user

### 1.1.1 Display Overview

#### Indicators Used in Header Area

	Power Source & Battery Level		Conductivity range of the probe
	Power Source: DC Adapter		Average slope of the pH probe
	Data Transmission mode: LED		Current Time in 24 Hour format
	Data Transmission mode: Infrared		Password Protection: Disabled
	Data Logging Mode: Internal Memory		Password Protection: Enabled

### 1.1.2 Key Functions

Key	Function
	<ul style="list-style-type: none"> <li>▪ Selects the function shown (in the display) just above the key. (For ON key, press and hold for 3 seconds.)</li> </ul>
	<ul style="list-style-type: none"> <li>▪ Navigates to next available functions</li> </ul>
	<ul style="list-style-type: none"> <li>▪ Increment/decrement values in Setup &amp; Calibration modes.</li> <li>▪ Navigates to sub groups in Setup selection screen.</li> </ul>
	<ul style="list-style-type: none"> <li>▪ In Setup mode, confirms selection or modified values</li> <li>▪ In Calibration mode, confirms calibration points or modified values</li> </ul>

## 1.2 Inserting Batteries

**NOTE:** Please ensure that the gasket is in place otherwise the instrument will not be waterproof.

Power up your meter using either:

1. Four 'AA' size 1.5 V alkaline batteries (supplied) or,
2. 9V DC power adapter (Optional in some models).

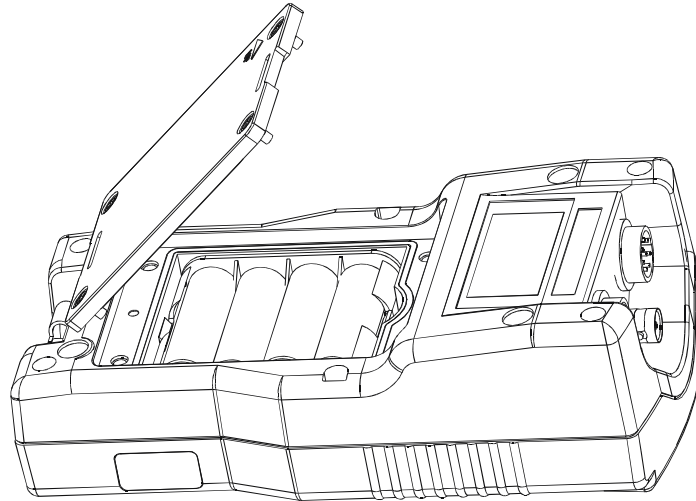

### 1.2.1 Inserting batteries for the first time

1. Use a Phillips screw driver to remove the four screws holding the battery cover.
2. Insert the batteries in the right direction.
3. Replace the battery cover and screws. Note the **▲UP** symbol marked on the cover.
4. Press the **ON (F4)** key. Hold the key down until the display appears.
5. Set the system date & time before you start operating the meter for the first time.

### 1.2.2 Changing batteries subsequently

1. Connect the adapter before changing the batteries.
2. If DC adapter is not available, **switch off the meter** and change the batteries within **30** seconds to avoid resetting the clock. This prevents the system time from resetting automatically.

### 1.3 Attaching the Belt

#### To attach the safety belt:

1. Use a Phillips screw driver to remove the four screws holding the battery cover.
2. Insert the safety belt through the two slots as indicated below.
3. Screw the battery cover back on. Note the ▲UP symbol marked on the cover.
4. Insert your palm between the belt and the body of the meter and adjust the hook & loop fastener.

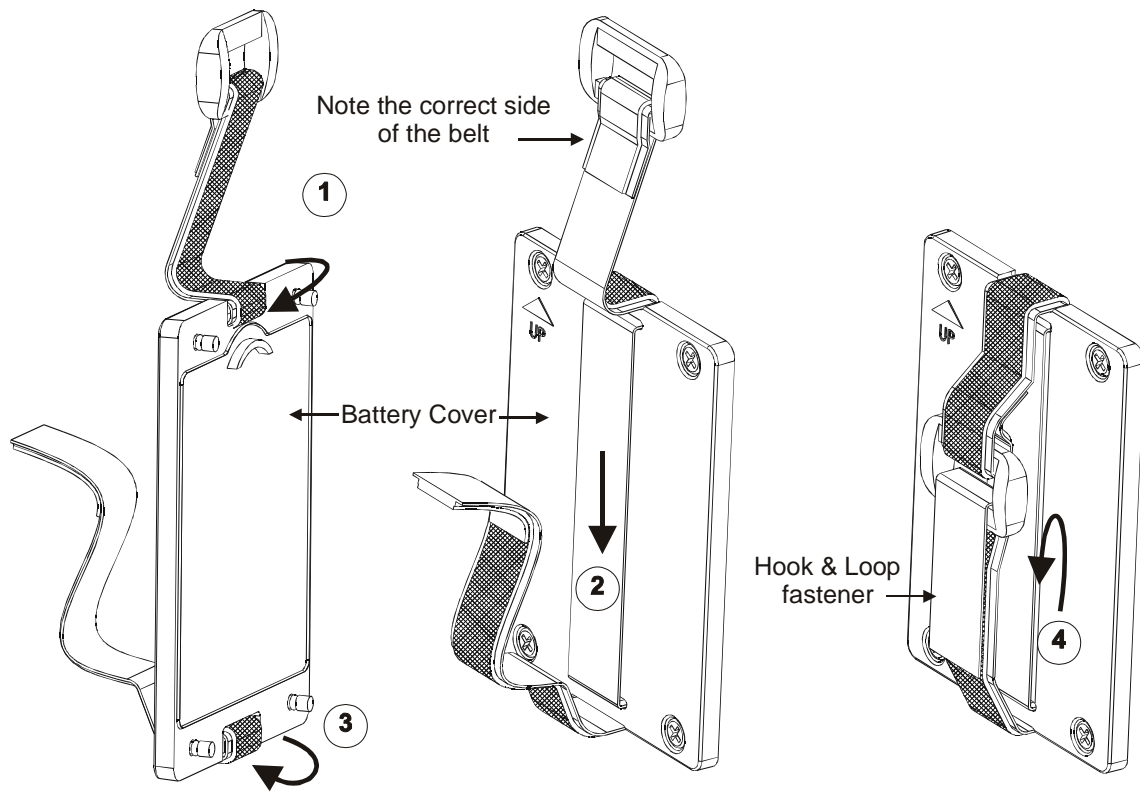

## 1.4 Connecting Peripherals

### 1.4.1 Probes (pH/Conductivity/DO)

Attach the probes with correct type of connectors as indicated.

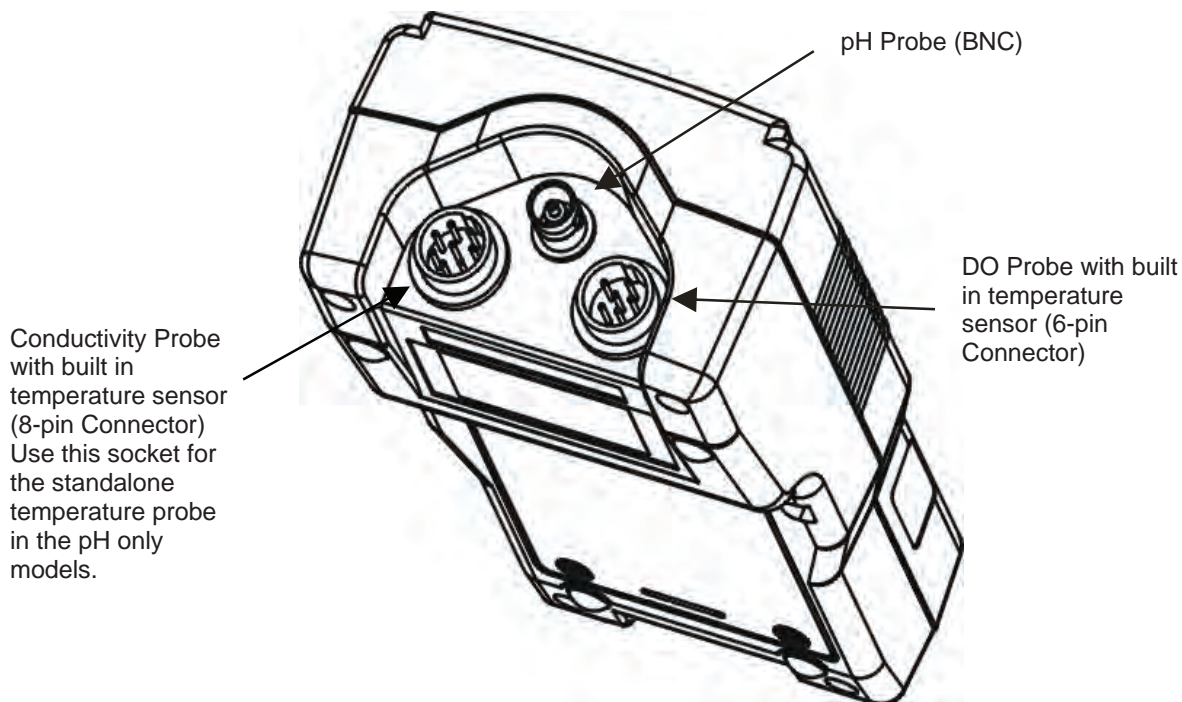

Use the electrode properly for best results:

1. Keep the protective plastic electrode guard in tact during measurement and calibration. **DO NOT REMOVE IT.**
2. Always immerse the electrode beyond upper steel band as shown.
3. Be sure to remove the protective electrode storage bottle or rubber cap of the pH electrode before calibration or measurement.

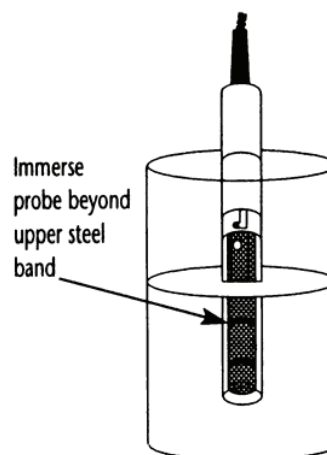

**NOTE:** If the electrode has been stored dry, wet the electrode in clean water for 10 minutes before calibrating or taking readings to saturate the pH electrode surface and to minimize drift.

### 1.4.2 Protective Rubber Boot

The rubber boot protects the meter when used in the field. For bench top applications, lift up the stand at the back of the rubber boot.

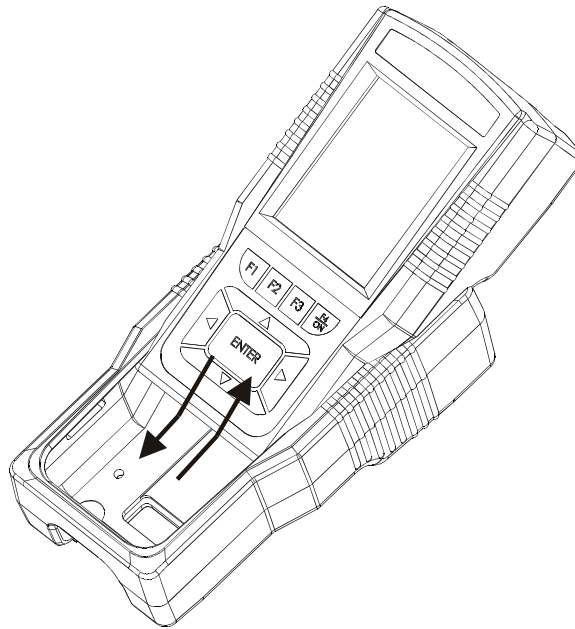

**PLEASE SET UP THE SYSTEM BEFORE YOU BEGIN USING THE METER. USE THE FOLLOWING OVERVIEW FOR SETUP MODE:**

## 2. System Setup Mode For All Meters



### 2.1 About Setup Mode

The setup mode lets you configure various parameters & settings of the meter. You can choose to password-protect your settings, so that other users who may use the meter will not be able to change the settings.

Setup mode consists of the following sub-groups:

- **System** – General settings of the meter
- **pH / mV / Ion / Conductivity / TDS / Salinity / Resistivity / O<sub>2</sub> mg/L (ppm) / O<sub>2</sub> (%)** – The pH / mV / Ion / Conductivity / TDS / Salinity / Resistivity / O<sub>2</sub> mg/L (ppm) / O<sub>2</sub> (%) Setup screen presents many options to control the operating parameters of their respective mode (Please refer to individual parameter sections for more information).
- **Temperature** - Temperature measurement & calibration related settings.

### 2.2 Accessing Setup mode

1. Switch the meter on. The meter goes to measurement mode.
2. Press left  or right  arrow key on the keypad to navigate to other available functions until you see **SETP** function in the LCD.
3. Press **SETP (F1)** and Setup Key Function screen appears. This page describes the key functions for configuring various parameters and settings of the meter.

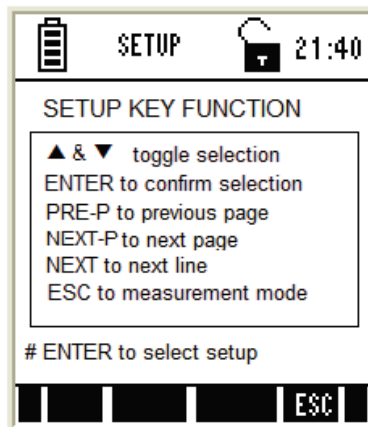

**Note:** If the meter is password protected, you will be prompted to enter a password before accessing Setup Key Function screen.

#### Function Keys available in setup key function screen:

	To select individual setup
ENTER	To select or confirm the selection.
NEXT-P	To navigate to next page.
NEXT	To go to next parameter without saving the changed parameter.
ESC	To go back to measurement mode.

1. Press **ENTER** key to select Setup Selection screen.
2. Press up ▲ or down ▼ arrow key to go to required setup sub-group.
3. Press **ENTER** key to select the currently shown sub-group.



Figure 1: Setup Selection Screen

Function keys available in setup selection screen:	
(F1)	(Not functional)
(F2)	(Not functional)
(F3)	(Not functional)
▲ ▼	Goes to required setup sub-groups
ENTER	Selects the current sub-group
ESC (F4)	Goes to measurement mode from where you entered setup
◀ ▶	(Not functional)

## 2.3 Setup Selection: System Settings

### System Settings Page 1 – General Settings

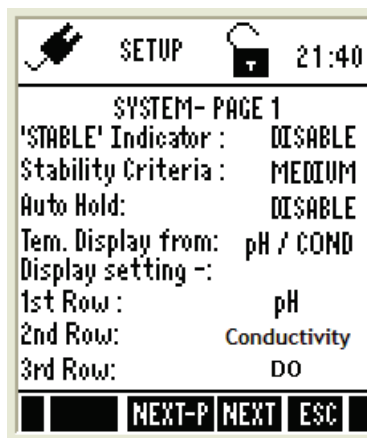

Figure 2: System Settings Page 1 – General Settings

System setup sub-group allows you to configure general settings of the meter. The settings are displayed in 6 pages. Press **NEXT-P (F2)** and **PREV-P (F1)** to navigate through these pages.

Parameter	Description	Factory Default
STABLE Indicator	ENABLE - The meter displays 'Stable' indicator in the measurement screen as per the 'STABLE CRITERIA' defined below. DISABLE – 'Stable' indicator does not appear.	ENABLE
Stability Criteria	SLOW – The reading is stabilized slowly and exhibits good repeatability MEDIUM – Reading stability is averaged between slow & fast stability FAST – Reading is stabilized quickly at the cost of repeatability. (This parameter has no effect if 'STABLE' parameter is disabled)	FAST
Auto Hold	ENABLE - The meter holds the reading in the measurement screen, if the reading is 'Stable' for 5 seconds. If this is enabled, 'Response time' appears in the measurement screen, indicating the average response time of the probe. DISABLE – The reading is not held (This parameter has no effect if 'STABLE' parameter is disabled. The response time may not work if the system time has not been set as described previously.)	DISABLE
Tem. Display from	Allows you to select temperature from pH/COND/DO probes to display in multi measurement screen. For PCD 650-pH/COND->DO	-
Display setting:-	Allows you to select multi modes that you would like to be displayed on the 1st and 2 <sup>nd</sup> row of the measurement screen after calibration. 1 <sup>st</sup> Row : pH / Ion / mV / Conductivity / Salinity / Resistivity / TDS / O <sub>2</sub> mg/L (ppm) / O <sub>2</sub> (%) 2 <sup>nd</sup> Row : pH / Ion / mV / Conductivity / Salinity / Resistivity / TDS / O <sub>2</sub> mg/L (ppm) / O <sub>2</sub> (%) 3 <sup>rd</sup> Row : pH / Ion / mV / Conductivity / Salinity / Resistivity / TDS / O <sub>2</sub> mg/L (ppm) / O <sub>2</sub> (%)	-

**Note:** In order to activate the RESPONSE TIME function, you have to first activate the STABLE and AUTO HOLD functions.

## System Settings Page 2 – Date & Time



Figure 3 : System Settings Page 2 – Date & Time

This page allows you to set the date & time of the meter.

Parameter	Description	Factory Default
Year	Sets the current year	2006
Month	Sets the current month	Jan
Date	Sets the current date	01
Hour	Sets the hour (24 Hours) for the current time	00
Minute	Sets the minute for the current time	00
Second	Sets the second for the current time	00

## System Settings Page 3 – Auto-Off & Backlight

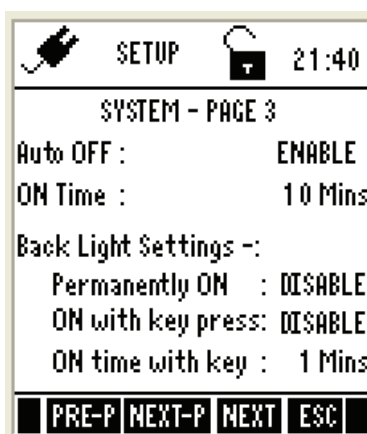

Figure 4 : System Settings Page 3 – Auto-Off & Backlight

This page allows you to set auto-off and back light related parameters.

Parameter	Description	Factory Default
Auto OFF	ENABLE – Turns the meter off automatically if no key is pressed for the time period specified in 'ON TIME' below. However, this will happen only if you are using the battery, <b>NOT</b> when the meter is plugged into an AC power source or when it is printing data.	ENABLE

	DISABLE – Meter does not turn off automatically.	
ON Time	After the last key is pressed, no. of minutes the meter should wait before automatically shuts down the meter. Maximum range: 30 min (This parameter has not editable if 'AUTO OFF' parameter is disabled)	10 min
Back Light (permanently ON)	ENABLE – Sets the back light always on. DISABLE – Sets the backlight always off.	DISABLE
Back Light ON with (Key press)	ENABLE – The back light of the LCD is automatically on when any key is pressed. DISABLE – Does not turn on the back light automatically.	DISABLE
ON time with (Key press)	Sets the meter to wait for specified number of minutes before automatically turning off the back light after the last key is pressed. (This parameter is not editable when 'BACK LIGHT (Key press)' is disabled) (This parameter has no effect if 'BACK LIGHT (Always)' parameter is set to ON)	1 min

**Note:** The above settings may not work if the system time has not been set as described previously.

### System Settings Page 4 – Wireless Serial Data Communication



Figure 5: System Settings Page 4 – Wireless Serial Data Communication

This allows you to set wireless serial data communication related parameters.

Parameter	Description	Factory Default
Print Mode	IrDA – Sets serial data communication protocol to IrDA LED – Sets serial data communication protocol to RS232C MEM- Logs data to meter's memory.	IrDA
Data Format	CyberComm – Select this format if you use CyberComm Data Acquisition Software (DAS)	CyberComm

	TEXT – Select this format if you use any other method (such as Windows® Hyperterminal)	
	This parameter is used when downloading data from the meter through IrDA	
Current Data Set	TIMED – Prints measurement data continuously at the interval specified in 'INTERVAL' parameter below. SINGLE – Prints only the currently measured reading	TIMED
	This parameter applies when PRIN key is pressed from measurement mode to send the currently measured readings to the computer.	
Interval (3 Sec Step)	Time interval at which the meter should send currently measured data to the printer/CyberComm/PCD Acceptable range : 3 sec to 600 sec (in 3 sec steps)	9 Sec
	(This parameter is applicable when 'CURRENT DATA SET' is set to 'TIMED' and this is not editable when 'CURRENT DATA SET' is set to 'SINGLE')	
Fixed Setting	Indicates serial communication settings in the format of 'Baud rate, Data bits-Parity bits-Stop bits'. This parameter is not editable.	2400 8-N-1

### System Settings Page 5 – Password Protection

This allows you to enable password protection for the setup mode & calibration mode:



Figure 6: System Settings Page 5 – Password Protection

When you enable password protection, the meter prompts you to enter the password whenever you try to access the Setup or Calibration mode. The meter does not allow you to edit setup parameters or perform a new calibration unless you enter the correct password. If an incorrect password is entered for 3 consecutive times, the meter goes to measurement mode.

Parameter	Description	Factory Default
Password	ENABLE – Sets password protection for the setup &	DISABLE

Protection	calibration mode. If this is enable you need to specify a 5-digit password in the 'SET PASSWORD' parameter below DISABLE – Disable password protection of the meter	
Set Pass Word	Specify your 5-digit password here. Use ▲ (Up) & ▼ (Down) key to select a number and then press <b>ENTER</b> key to confirm and move to the next digit.	88888
	Do not set your password to '00000' as this is reserved for 'read-only' password. (This parameter is not editable when 'PASSWORD PROTECT' is disabled)	
Confirm New Password	YES – Select this if you have made changes to the password and you wish to confirm the changes. NO – Select this if you wish to ignore the changes made to the password and to store the default password.	NO

**Important:**

1. Please memorize the password that you have entered after enabling the password protection. Without it, you can't disable the password protection or reset the meter to factory defaults. However, **if the user forgets his password, he can contact the nearest distributor or Eutech Instruments/Oakton Instruments to request for meter password.** This would be unique to each instrument and would be tied to the serial number of the unit.
2. Default password '88888' is valid only if it is not changed with new password.
3. You can enter '00000' (read-only password) if you wish to view the setup parameters. You are not allowed to modify any parameter when you enter 'read-only password'.

**System Settings Page 6 – Data Memory & Factory Settings**

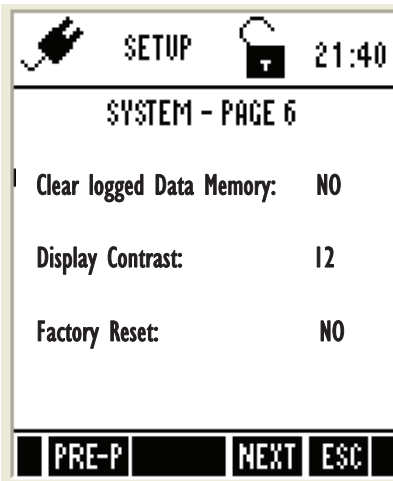

Figure 7: System Settings Page 6 – Data Memory, Display Contrast & Factory Settings

This allows you to clear the memory, display contrast and reset the meter to factory defaults.

Parameter	Description	Factory Default
Clear logged Data Memory	YES – Select this to clear all the stored data from the meter's memory NO – Select this if you do not wish to clear the stored data from the meter's memory	NO
Display Contrast	Adjust display contrast from 1 - 25	12
Factory Reset	YES – Select this if you wish to reset the meter to its factory default settings. This includes: <ul style="list-style-type: none"> <li>▪ Deleting your calibration data</li> <li>▪ Resetting setup parameters to factory defaults (except date &amp; time)</li> <li>▪ Deleting your stored data in the memory</li> </ul> NO – Select this if you do not wish to reset the meter.	NO

When 'YES' is selected and confirmed by pressing ENETR key, the meter is reset to factory defaults and then the meter goes to measurement mode.

## 2.4 Accessing Setup mode when password protection enabled

1. Switch the meter on. The meter goes to measurement mode.
2. Press right arrow key  to navigate to other functions on the right-side of LCD.
3. Press **SETP (F1)** to go to Setup mode. Login password screen appears. The meter expects the 5-digit password specified in system setup.



Figure 8: Login Password

**Note:** You can enter '00000' (read-only password) if you wish to view the setup parameters. You are not allowed to modify any parameter when you enter 'read-only password'.

1. Press up ▲ & down ▼ arrow keys to enter the first digit of the password and then press **NEXT (F3)** key to move to the next digit.
2. The next digit is selected. Press up ▲ & down ▼ arrow keys to enter the second digit of the password. Enter all 5-digits.
3. Press **ENTER** key to confirm the password.

**Note:** If you enter an incorrect password, the screen shows "Try Again". If an incorrect password is entered three consecutive times, the meter goes into measurement mode. If you forget the password, there is no way to access the system setting and calibration. Please contact your authorised dealer for assistance.

1. When the correct password is entered, the Setup Key Function Screen appears.
2. Press **Enter** key to launch Setup Selection Screen. Press up ▲ or down ▼ arrow key to go to required setup sub-group.
3. Press **ENTER** key to select the sub-group.

## 2.5 Modifying Setup parameters

1. Press **NEXT (F3)** key to select individual setup parameters sequentially.
2. Press ▲ (Up) or ▼ (Down) arrow key to change the value of a selected parameter.
3. Once you have changed a value:
  - Press **ENTER** key to save the change, or
  - Press **NEXT (F3)** key to go to the next parameter without saving the changed parameter.
4. Press **NEXT-P (F2)** or **PRE-P (F1)** to navigate to next or previous page.
5. Press **ESC (F4)** to exit from setup mode.

(Refer to Page 9 for current function keys settings)

## 3. Calibration Mode For All Meters

### 3.1 About Calibration

The 600 series meters are factory calibrated and allows you to measure pH/mV/ion/conductivity/resistivity/TDS/salinity/DO(%)/DO(mg/L) respective to the model(s) you have purchased. Calibrate to all measurement ranges to ensure the highest accuracy in any given measurement range. This should be done before you make measurements for the first time and also each time a new electrode is attached to the meter or when you suspect that the meter/electrode is out of calibration.

### 3.2 About Conductivity/ Resistivity/ TDS/ Salinity Calibration

Before measuring conductivity, resistivity, TDS or salinity, you will need to calibrate the meter with known conductivity, resistivity, TDS or salinity values.

The meter is capable of performing either automatic or manual calibration.

In the automatic calibration mode, the meter automatically detects and verifies the appropriate known calibration standards solutions being calibrated before accepting these particular calibration standards as one of its calibration values in a specific measurement range. This automatic calibration mode frees you from cumbersome calibration procedure.

The meter can perform a single- or multi-point calibration. You will need to set your meter to single- or multi-point calibration in the Setup mode for conductivity, resistivity, TDS or salinity.

Refer to the setup section for the particular mode you will be measuring. Instead of calibrating for TDS directly using TDS calibration standard solutions, you can have TDS calibration by using the conductivity calibration method and enter the appropriate TDS conversion factor into the meter.

For more information regarding TDS Conversion Factor determination, please go to the 'Appendix' of this manual.

### 3.3 Preparing the Meter for Calibration

Before starting calibration, make sure the meter is in the appropriate measurement mode.

#### For pH

Connect the pH probe to the BNC connector of the meter.

Be sure to remove the protective electrode storage bottle or rubber cap of the electrode before calibration or measurement. If the electrode has been stored dry, wet the electrode in clean water for 10 minutes before calibrating or taking readings to saturate the pH electrode surface and minimize drift.

Wash your electrode in clean water after use, and store in electrode storage solution. If storage solution is not available, use pH 4.01 or 7.00 buffer solution. Do not reuse buffer solutions after calibration. Contaminants in the solution can affect the calibration, and eventually the accuracy of the measurements.

It is recommended that you perform at least a 2-Point Calibration using standard buffers that adequately cover the expected measurement range, prior to measurement.

### **For Ion**

Connect the ISE to the BNC connector of the meter.

Remove plastic protective cap of ISE. Briefly rinse the electrode with clean water to remove any residues. Rinse ISE before and after each calibration or sample measurement to avoid cross-contamination. Ensure that you use new or fresh standard solutions during calibration. Do not reuse Ion standard solution as it may be contaminated and affect the calibration and accuracy of measurements.

### **For Conductivity**

Connect the conductivity probe with built-in temperature sensor into the 8-pin connector of the meter.

For best results, select a standard value close to the sample value you are measuring. Alternatively use a calibration solution value that is approximately 2/3 the full-scale value of the measurement range you plan to use. For example, in the 0 to 2000  $\mu\text{S}$  conductivity range, use a 1413  $\mu\text{S}$  solution for calibration.

Perform calibration for all measurement ranges to ensure the highest accuracy throughout all measurement range.

If you are measuring in solutions with Conductivity lower than 100  $\mu\text{S}/\text{cm}$  or TDS lower than 50 ppm, calibrate the meter at least once a week to ensure accuracy. If you are measuring in the mid ranges and you wash the electrode in de-ionized water and store it dry, calibrate the meter once a month. If you take measurements at extreme temperatures, calibrate at least once a week.

Ensure that you use new conductivity standard solutions or sachets during calibration. Do not reuse standard solutions as it may be contaminated and affect the calibration and accuracy of measurements. Use fresh calibration solution each time you calibrate your meter. Keep solutions in a dry and cool environment if possible.

### **For DO(%) and DO (mg/L) Calibration**

Before starting calibration, make sure you are in the correct measurement mode and in the correct calibration sequence. **The temperature and the % Saturation calibration must be done first before attempting to do the mg/L (ppm) Concentration calibration.**

Rinse the probe well in the de-ionized (DI) water or rinse solution and wipe the probe carefully taking care of the membrane.

Calibrate the meter in all the modes to ensure the highest accuracy throughout the DO measurement range. In % Saturation, the meter is able to perform either a one point calibration or a 2 point calibration. For one point calibration, it is recommended that you perform a 100% Saturation calibration in saturated air. If you opt for 2 point calibration, you can calibrate for 100% Saturation in saturated air and 0% Saturation using a zero oxygen solution.

All new calibration values will automatically override the existing data. It is recommended to calibrate the meter periodically and or if it is suspected to be inaccurate.

Always rinse the probe with either DI water or rinse solution before and after each calibration/sample measurement. When calibrating in air, make sure that any water droplets from the probe's membrane are removed.

### 3.4 Accessing Calibration mode

From measurement mode, press **CAL (F2)** key. The meter goes to corresponding calibration mode, based on the selected measurement mode. If the meter is password protected, you will be prompted to enter password.

#### 3.4.1 Accessing Calibration mode when password protection enabled

1. Make sure you are in measurement mode. If required, press **MODE (F3)** to switch to the measurement mode for which you wish to perform calibration.
2. Press **CAL (F2)** to go to calibration mode. Login Password screen appears (Figure 9). The meter expects the 5-digit password specified in system setup.



Figure 9 : Login Password

**Note:** You can enter '00000' (read-only password) if you wish to view the calibration report of the last calibration. You are not allowed to perform calibration when you enter 'read-only password'.

1. Press up ▲ & down ▼ arrow keys to enter the first digit of the password and then press **NEXT (F3)** key to move to the next digit.
2. The next digit is selected. Press up ▲ & down ▼ arrow keys to enter the second digit of the password.
3. Similarly enter all 5-digits.
4. Press **ENTER** key to confirm the password.
5. When the correct password is entered, the 'Calibration – Rinse Electrode' screen will appear.

**Note:** If you enter an incorrect password, the screen shows 'Try again'. If an incorrect password is entered for 3 consecutive times, the meter goes to measurement mode.

## 4. Measurement Mode For All Meters

### 4.1 About Measurement Mode

The following is the full range of measurement modes in the WP 600 series meters:

- Temperature measurement mode
- pH measurement mode
- mV measurement mode
- Ion measurement mode
- Conductivity measurement mode
- TDS measurement mode
- Salinity measurement mode
- Resistivity measurement mode
- O2 % - DO percentage saturation measurement mode
- O2 mg/L (ppm) - DO concentration mode

Only the PCD 650 model is equipped with all of them.

The meter automatically goes to the mode that was used before it was turned off the last time. Press **MODE (F3)** key to select your required measurement mode.

#### 4.1.1 Accessing functions

There are many functions available in the measurement mode. Use the 4 Function keys (F1, F2, F3 & F4) to access them. The first group of functions appear when you enter the measurement mode. Press the left ◀ or right ▶ arrow key to navigate to the 2<sup>nd</sup> and 3<sup>rd</sup> function groups.

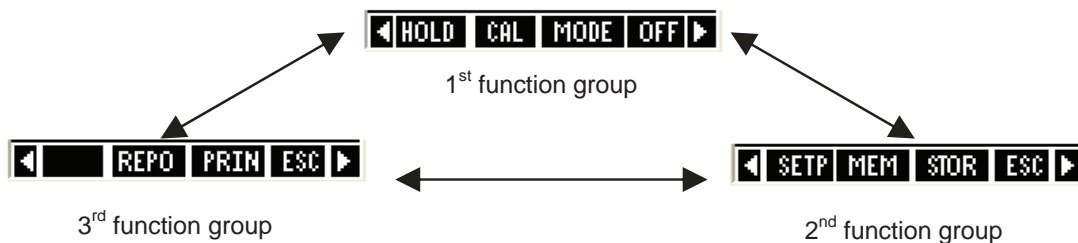

#### Function Keys available in measurement screen (1<sup>st</sup> Group):

<b>HOLD (F1)</b>	Holds the current reading in the display. The 'HOLD' indicator starts blinking. Press HOLD key again to release the reading
<b>CAL (F2)</b>	Goes to corresponding calibration mode (based on the selected measurement mode)

<b>MODE (F3)</b>	Switches between measurement modes
<b>OFF (F4)</b>	Power off the meter (press and hold this key for 3 seconds)
<b>◀ ▶</b>	Switches between functions groups available in measurement mode
<b>ENTER</b>	(Not functional)
<b>▲ ▼</b>	(Not functional)
<b>Function Keys available in measurement screen (2<sup>nd</sup> Group):</b>	
<b>SETP (F1)</b>	Goes to setup mode
<b>MEM (F2)</b>	Shows stored data in the memory
<b>STOR (F3)</b>	Stores the currently displayed reading in the memory
<b>ESC (F4)</b>	Shows 1 <sup>st</sup> Group of functions
<b>Function Keys available in measurement screen (3<sup>rd</sup> Group):</b>	
<b>REPO(F2)</b>	Shows corresponding calibration report (based on selected measurement mode)
<b>PRIN (F3)</b>	Sends the currently displayed reading to the computer through IrDA. (This key has to be pressed to establish communication with CyberComm PCD application through IrDA). If data logging mode has been selected in System Setup then it sends data automatically to meter's memory.
<b>ESC (F4)</b>	Shows 1 <sup>st</sup> Group of functions
<b>◀ ▶</b>	Switches between functions groups available in measurement mode
<b>ENTER</b>	(Not functional)
<b>▲ ▼</b>	(Not functional)

**Note:** If you press a function key that is not relevant to measurement mode (for example ENTER, ▲, ▼) the meter shows 'Invalid key!' message in the footer area of the screen as shown here.



Figure 10 : Invalid Key Prompt

## 4.2 Taking Measurements

### 4.2.1 Prepare the meter for measurement

Perform a calibration test if you change to a new probe and connect the probe to the meter before measuring.

### 4.2.2 Taking a reading

1. Press **ON (F4)** key to switch the meter on. Hold for 3 seconds.
2. Press **MODE (F3)** to select your required mode.
3. Dip the appropriate probe into the sample solution.
4. The LCD shows a '**Stable**' indicator if this feature was enabled during the setup. Note the reading.

### 4.2.3 Stable reading indicator

You can configure the meter so that LCD displays a '**Stable**' indicator when the reading does not vary for 2 consecutive seconds. The amount of variations allowed can be set at 'Slow', 'Medium' or 'Fast'.

### 4.2.4 Holding a reading

In some situations, you may want to freeze (hold) the measured reading in the LCD for a delayed observation. You can hold a reading in two different ways:

**Manual Hold** – Allows you to hold the reading by pressing **HOLD (F1)** key at any time you want. When you hold a reading, the '**HOLD**' indicator starts flashing. The readings (including temperature reading) will be held until you press any other key again.

**Auto-Hold** –The meter automatically holds the reading if it is '**Stable**' for 5 consecutive seconds. This feature needs to be enabled in the setup. Press **HOLD (F1)** key to release the reading.

## 4.3 Automatic Temperature Compensation (ATC)

Connect an appropriate probe to the meter and select 'ATC mode' in the temperature setup for the pH/ conductivity/ DO reading to be automatically compensated for temperature variations.

If you select 'ATC' without connecting a probe to the meter, the LCD will show the word 'UNDER' for temperature reading.

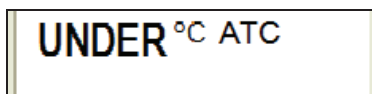

Figure 11: Under Range

**Note:** The factory default value for normalization temperature is 25°C.

### 4.3.1 Manual Temperature Compensation (MTC)

If an ATC probe is not available, you can choose to manually compensate for the temperature. This is suitable when the temperature of your sample is sufficiently stable. Select 'MTC mode' in the temperature setup. Press **CAL (F2)** and then press **NEXT** key. Press **TEMP (F1)** to go to temperature calibration. Enter the temperature value of your sample.

#### 4.4 Alarm set point (For pH/conductivity/DO)

You can set the meter to display an alarm when the pH/ conductivity/ salinity/ resistivity/ TDS/ DO (%)/ DO (mg/L) reading goes higher or lower than predefined set points. Refer to 'Setup' pages of respective modes to set alarm points for pH, conductivity and DO.

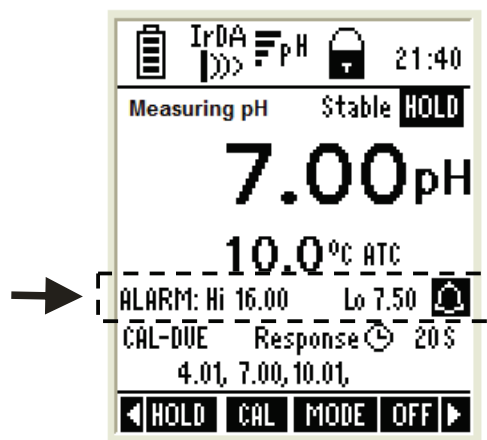

Figure 12 : Hi Alarm

#### 4.5 Calibration Due (CAL-DUE) Indicator (For pH/conductivity/DO)

You can set a reminder to be displayed in the LCD when the next calibration is due. Set the number of days in the pH/conductivity/DO Setup and the meter will remind you when the days elapse from your last calibration date.

## 5. TRANSFERRING AND PRINTING DATA

*Please refer to this section after completing calibrations and taking measurements.*

#### 5.1 CyberComm 600 Data Acquisition Software

Your meter is shipped with a companion software application called **CyberComm 600 Data Acquisition Software (DAS)**.

For details on installation, connection and usage of the software, please read the manual that comes with the software CD.

#### 5.2 Working with Memory functions – Auto Data Logging

The 600 series meters have a memory capacity to store up to 500 sets of data measurements. You can view the stored data using the **MEM (F2)** function key. You can also transfer this data wirelessly via infrared to a Computer or print it directly to a microprinter.

### 5.2.1 Logging data automatically in the meter's memory

1. Make sure that the Print mode is set to 'data logging mode' in the System Setup. You can also specify the time interval for each transfer.
2. From measurement mode, press **PRIN (F3)** to start saving data automatically in meter's memory. The memory location of the transferred reading is shown in the bottom-left of the screen.

**NOTE:** This symbol will appear if data logging mode has been selected in "System set up". It will automatically start saving data in meter's memory, when **PRIN (F3)** key is pressed.

Memory Location where readings are being saved.

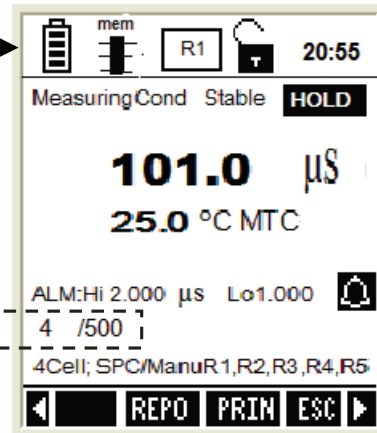

### 5.2.2 Storing a current measurement (In IrDA and LED print mode: Applicable to all modes)



1. Make sure you are in the measurement mode.
2. Press left or right arrow key to navigate to other available functions until you see **STOR** function in the LCD.
3. Press **STOR (F3)** key to store the current reading. The bottom left of the screen will show the memory location where this reading is being saved.

### 5.2.3 Viewing stored data

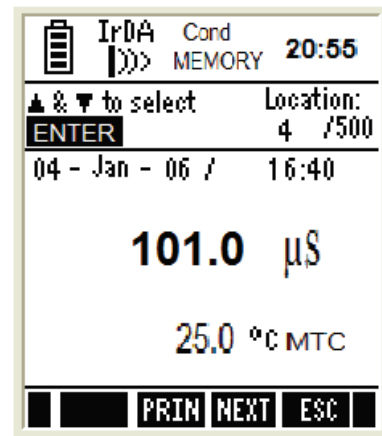

1. Make sure you are in measurement mode.
2. Press left or right arrow key to navigate to other available functions until you see **MEM** function in the LCD.
3. Press **MEM (F2)** key to view the stored data. The last data entry stored is shown in the display with its memory location at the top-right corner of the screen [Immediately under the time]. (See following diagram)
4. To navigate to a particular memory location, press the up or down arrow key to select it and then press the **ENTER** key. The meter will show the stored data in the memory location you selected.
5. Press **NEXT (F3)** key to return to the measurement mode.
6. Press **ESC (F4)** key to return to the main screen of the measurement mode.

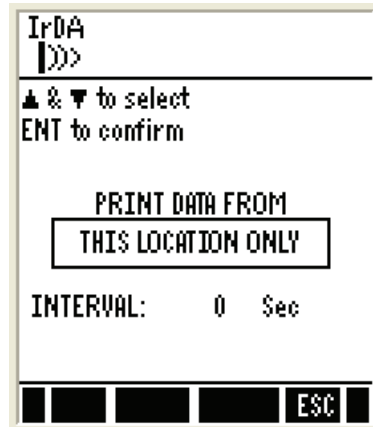

#### 5.2.4 Transferring stored data to the Computer (CyberComm) through IrDA

1. Make sure the **CyberComm 600** application is up and running (Refer to the manual in the software packaging to install).
2. Make sure your meter's IrDA port is facing the IrDA port of the computer.
3. Go to the 'stored data viewing' screen as shown above diagram (Use MEM [F2] key).
4. Press **PRIN (F2)**. The screen appears for you to select printing options.
5. Press up  or down  arrow key to select either 'all (memory) locations' or the 'current memory location', and then press **ENTER** key.



6. If you have selected **ALL LOCATIONS**, then you can specify the time interval in between each transfer. Press up  or down  arrow key to select from 1 to 50 second intervals then press **ENTER** key.
7. At the CyberComm screen on your computer, press **Find Device** button.
8. Once CyberComm finds the meter, click the **Connect** button to establish a connection.
9. Data will be sent from your meter to the computer through IrDA and the connection will stop automatically when the transfer is complete.
10. You can save the transferred data in your choice format : .txt, .xls etc.



### 5.2.6 Transferring stored data to a PC using an USB/ irDA Dongle.



You can purchase an USB/ irDA dongle 01X447601 (see accessories page at the back of this manual) and transfer data from your meter using the USB port.

**Please note:** This accessory is specially engineered to match your meter's software to the application in your laptop or PC. If you purchase this item from a different source, it will **NOT** be compatible for transferring the data.

## 6. Technical Specifications

Temperature (pH and Conductivity)			
Range	-10.0 °C to 110.0 °C (14.0 °F to 230.0 °F)		
Resolution	0.1 °C/ 0.1 °F		
Relative Accuracy	± 0.5 °C / ± 0.9 °F		
Temp. Input Connector	8-pin Round		
Temperature (DO)			
Range	-10.0 °C to 60.0 °C (14.0 °F to 140.0 °F)		
Resolution	0.1 °C/ 0.1 °F		
Relative Accuracy	± 0.5 °C / ± 0.9 °F		
Model			
pH	pH 600	pH 610	pH 620, PD 650,PCD 650
Range	-2.00 to 20.0 pH	-2.000 to 20.000 pH	
Resolution	0.1/ 0.01 pH	0.1/0.01/0.001 pH	
Relative Accuracy	± 0.01 pH + 1 LSD	± 0.002 pH + 1 LSD	
No. of Calibration points	1 (offset) to 6 points		
No. of Buffer Options	15		
Calibration due alarm	User configurable (up to 30 days)		
Set point alarm	User configurable		
Auto buffer recognition	Yes		
pH buffer Groups & Calibration Points	USA : 1.68, 4.01, 7.00, 10.01, 12.45 NIST: 1.68, 4.01, 6.86, 9.18, 12.45 DIN : 1.09, 3.06, 4.65, 6.79, 9.23, 12.74 PWB : 4.10, 6.97		
Calibration Window	USA	± 1.5 pH (for 7.00pH), ±1 pH (for all other buffers)	
	NIST	± 1.35 pH (for 6.86pH), ±1 pH (for all other buffers)	
	DIN	± 0.8 pH (for 1.09, 3.06, 4.65pH), ±1 pH (for 9.23, 12.74pH), ±1.34 pH (for 6.79pH)	
	PWB	± 0.8 pH	
Custom buffer calibration	Yes (2 to 5)		
Slope/Offset display	Yes (Display + Icon)		
mV			
Range	± 2000.0mV		
Resolution	0.1 mV		
Relative Accuracy	± 0.2 mV + 1 LSD		
Ion			
Range	0.001 to 19900		
Units	ppm, molar, mg/L		
Resolution	2 or 3 digits		
Relative Accuracy	0.5% FS (monovalent) 1% FS (divalent)		

Conductivity				
Range	Measuring ranges	Resolution	Sub range Accuracy	Cal Standards
1	0.050uS to 2.000uS	0.01uS*	1% of FS	No
2	2.000uS to 9.990 uS	0.01uS*	1% of FS	84.00uS
	10.00uS to 99.99uS	0.01uS	1% of FS	
	100.0uS to 300.0uS	0.1uS	1% of FS	
3	300.0uS to 999.9uS	0.1uS	1% of FS	1.413mS
	1.000mS to 4.000mS	0.001mS	1% of FS	
4	4.000mS to 9.999mS	0.001mS	1% of FS	12.88mS
	10.00mS to 40.00mS	0.01mS	1% of FS	
5	40.00mS to 99.99mS	0.01mS	1% of FS	111.8mS
	100.0mS to 500.0mS	0.1mS	1% of FS	
* Display resolution is 0.001 but actual resolution shows 0.01.				
TDS				
Range	Measuring ranges	Resolution	Sub range Accuracy	
1	0.050ppm to 2.000ppm	0.01ppm*	1% of FS	
2	2.000ppm to 9.990 ppm	0.01ppm*	1% of FS	
	10.00ppm to 99.99ppm	0.01ppm	1% of FS	
	100.0ppm to 300.0ppm	0.1ppm	1% of FS	
3	300.0ppm to 999.9ppm	0.1ppm	1% of FS	
	1.000ppt to 4.000ppt	0.001ppt	1% of FS	
4	4.000ppt to 9.999ppt	0.001ppt	1% of FS	
	10.00ppt to 40.00ppt	0.01ppt	1% of FS	
5	40.00ppt to 99.99ppt	0.01ppt	1% of FS	
	100.0ppt to 500.0ppt	0.1ppt	1% of FS	
* Display resolution is 0.001 but actual resolution shows 0.01.				
Salinity				
Range	Measuring ranges	Resolution	Sub range Accuracy	
1	0.020ppm to 0.770ppm	0.01ppm*	1% of FS	
2	0.770ppm to 9.990 ppm	0.01ppm*	1% of FS	
	10.00ppm to 99.99ppm	0.01ppm	1% of FS	
	100.0ppm to 143.3ppm	0.1ppm	1% of FS	
3	143.3ppm to 999.9ppm	0.1ppm	1% of FS	
	1.000ppm to 2.138ppt	0.001ppt	1% of FS	
4	2.138ppt to 9.999ppt	0.001ppt	1% of FS	
	10.00ppt to 23.64ppt	0.01ppt	1% of FS	
5	23.64ppt to 80.00ppt	0.01ppt	1% of FS	
* Display resolution is 0.001 but actual resolution shows 0.01.				

Resistivity			
Range	Measuring ranges	Resolution	Sub range Accuracy
5	10.00M $\Omega$ to 20.00M $\Omega$	0.01M $\Omega$	1% of FS
	1.000M $\Omega$ to 9.999M $\Omega$	0.001M $\Omega$	1% of FS
	500.0K $\Omega$ to 999.9K $\Omega$	0.1K $\Omega$	1% of FS
4	100.0K $\Omega$ to 500.0K $\Omega$	0.1 $\Omega$	1% of FS
	10.00K $\Omega$ to 99.99K $\Omega$	0.01 $\Omega$	1% of FS
	3.333K $\Omega$ to 9.999K $\Omega$	0.001 $\Omega$	1% of FS
3	1.000K $\Omega$ to 3.333K $\Omega$	0.001 $\Omega$	1% of FS
	250.0 $\Omega$ to 999.9 $\Omega$	0.1 $\Omega$	1% of FS
2	100.0 $\Omega$ to 250.0 $\Omega$	0.1 $\Omega$	1% of FS
	25.00 $\Omega$ to 99.99 $\Omega$	0.01 $\Omega$	1% of FS
1	10.00 $\Omega$ to 25.00 $\Omega$	0.01 $\Omega$	1% of FS
	2.000 $\Omega$ to 9.990 $\Omega$	0.01 $\Omega$ *	1% of FS
* Display resolution is 0.001 but actual resolution shows 0.01.			
Conductivity / TDS / Salinity / Resistivity		COND 600	COND 610
Conductivity Range		0 to 200mS	0 to 500 mS
Salinity		-	80 ppt
Resistivity		-	0 to 20.00M $\Omega$
TDS		200 ppt (depending on TDS factor)	500 ppt (depending on TDS factor)
Conductivity Cell constant		0.010 to 10.000	
Conductivity Cell		2 & 4 Cell	
TDS Conversion Factor		0.400 to 1.000	
Temperature Comp.		Linear	Linear & Pure
Cal-Auto/Manual		Yes	
Cal-Single/Multi		Yes	
Cal Due Alarm		Yes (max-30 days)	
Set Point Alarm		Yes	
Input Conductivity		8 Pin Round	
Dissolved Oxygen		DO 600, PD 650, CD 650, PCD 650	
DO Range		0 to 600 %/ 90 mg/l	
Resolution		0.1%, 0.01 mg/L	
Accuracy		$\pm$ 2%, $\pm$ 0.2 mg/L	
Dissolved Oxygen Probe		Galvanic	
Mode		% Sat, mg/L, ppm	
Temperature Comp.		Linear	
Barometric Pressure Compensation		Automatic	
Barometric Pressure Range		450 to 825 mmHg	
Barometric Pressure Resolution		1 mmHg	
Barometric Pressure Accuracy		$\pm$ 1%	
Salinity Correction		0 to 50 ppt	
Cal Due Alarm		Yes (max -30 days)	

Set Point Alarm	Yes	
Input DO	6 Pin Round	
<b>Display</b>		
Display type	Dot matrix LCD with backlighting	
Screen resolution	110 x 128	
Viewing area	68 x 74 mm	
Backlit	Yes	
<b>Other</b>		
Data logging	500 data sets	
Data communication	IrDA / RS232C-Infrared	
Auto Data logging	Yes	
GLP (Good Lab Practice)	Yes	
Ingress protection	IP 67	
Dimensions	95mm (W) x 185mm (L) x 58.5mm (H) - Without Rubber Boot 101mm (W) x 191mm (L) x 61mm (H) - With Rubber Boot	
Weight	380g (Without Rubber Boot)	
<b>Power Input</b>	<b>pH 600 / 610 / 620</b>	<b>All other models</b>
Battery	4 x Alkaline AA size, 1.5 V	
Battery Life	500 Hrs (without backlight & serial data transfer)	200 Hrs (without backlight & serial data transfer)
Power adapter	Input: 100-240V AC Output: DC 9-12V, 6W Max	

## 7. Accessories

### Eutech Instruments

Product Description	Eutech Instruments Order Code
8 pin connector Temperature probe (3m Cable)	ECPHWPTM03J
8 pin connector Temperature probe (1m Cable)	ECPHWPTM01J
General Purpose Plastic-Body, Double Junction, Ag/AgCl pH electrode (3m Cable)	ECFC7252203B
General Purpose Plastic-Body, Double Junction, Ag/AgCl pH electrode (1m Cable)	ECFC7252201B
General Purpose Plastic-Body, 3-in-1,pH/Temp Ag/AgCl pH electrode (1m Cable)	ECFC7352901J
2 Stainless Steel Rings Ultem-body Electrode with ATC (3m cable length)	ECCONSEN9103J
4-cell, Graphite, Epoxy-body Electrode with ATC (3m cable length)	ECCONSEN9203J
Galvanic Dissolved Oxygen probe with ATC (3m cable length)	ECDOHANDYNEW
Membrane & O-ring (pack of 5)	01X241603
Assembled Membrane Cap Housing	15X241402
Membrane removal tool	15X241502
Electrode Guard Removal Tool	15X241504
DO Refilling electrolyte, 60 mL	01X211226
Rubber Boot for 600 series meters	ECRUBBERBT600
100-240VAC Power Adapter	01X030132
USB/ IrDA Converter (1.1 Standard)	01X447601

### Oakton Instruments

Product Description	Oakton Instruments Order Code
8 pin connector Temperature probe (3m Cable)	35418-07
8 pin connector Temperature probe (1m Cable)	35418-05
General Purpose Plastic-Body, Double Junction, Ag/AgCl pH electrode (OKFC7252203B, 3m Cable)	35816-77
General Purpose Plastic-Body, Double Junction, Ag/AgCl pH electrode (1m Cable)	35641-51
General Purpose Plastic-Body, 3-in-1,pH/Temp Ag/AgCl pH electrode (1m Cable)	35816-71
2-cell Electrode with ATC, cell constant K=1.0 (OKCONSEN9103J, 3m cable)	35408-57
2-cell Electrode with ATC, cell constant K=1.0	35408-52
4-cell Electrode with ATC, cell constant K=0.3	35408-56

2-cell Electrode with ATC, cell constant K=10.0	35408-54
2-cell Electrode with ATC, cell constant K=0.1	35408-50
Galvanic Dissolved Oxygen probe with ATC with 10-ft cable	35640-50
Galvanic Dissolved Oxygen probe with ATC 25-ft cable	35640-52
Galvanic Dissolved Oxygen probe with ATC 50-ft cable	35640-54
Galvanic Dissolved Oxygen probe with ATC 100-ft cable	35640-56
Replacement batteries, AA. Pack of 4	09376-01
Replacement DO membranes, Pack of 5.	35640-74
Replacement DO membranes, Pack of 25.	35640-75
Replacement membrane kit; two membrane caps and one bottle of electrolyte solution	35640-80
Assembled Membrane Cap Housing	35640-72
Membrane removal tool	35640-79
Zero oxygen solution, 500 mL	00653-00
DO Refilling electrolyte , 500 mL	35640-71
Electrolyte DO powder (58.5 g)	35640-70
Rubber Boot for 600 series meters	35418-86
100-220VAC Power Adapter	35418-83
Carrying Case with 4 sets of empty 60 ml bottle	35632-99

## 8. Warranty & Return Policy

### 8.1 Warranty

Eutech Instruments supplies this meter with a 3-year warranty and 6-month warranty for electrode against manufacturing defects from the date of purchase. If repair or adjustment is necessary and has not been the result of abuse or misuse within the designated period, please return – freight pre-paid – and correction will be made without charge. Eutech Instruments/ Oakton Instruments will determine if the product problem is due to deviations or customer misuse.

Out of warranty products will be repaired on a charged basis.

#### Exclusions

The warranty on your instrument shall not apply to defects resulting from:

- Improper or inadequate maintenance by customer
- Unauthorized modification or misuse
- Operation outside of the environment specifications of the products

### 8.2 Return of Goods

Before returning goods for any reason whatsoever, the Customer Service Dept. has to be informed in advance. Items must be carefully packed to prevent

damage during shipment, and insured against possible damage or loss. Eutech Instruments/ Oakton Instruments will not be responsible for any damage resulting from careless or insufficient packing.

**Warning:** Shipping damage as a result of inadequate packaging is the user's/distributor's responsibility. Please follow the guidelines below before shipment.

### **8.3 Guidelines for Returning Unit for Repair**

Use the original packaging material if possible when shipping the unit for repair. Otherwise wrap it with bubble pack and use a corrugated box for additional protection. Include a brief description of any faults suspected for the convenience of Customer Service Dept., if possible.

- END OF GENERAL GUIDE SECTION -

## **TEMPERATURE**

### **PARAMETER GUIDE**

- i. Temperature Setup Mode
- ii. Temperature Calibration – ATC and MTC Mode
- iii. Temperature Measurement Mode

#### **FOR ALL MODELS :**

**pH 600/ 610/ 620**

**COND 600/610**

**DO 600**

**PC 650**

**PD 650**

**CD 650**

**PCD 650**

# 1. Temperature Setup

Temperature setup sub-group allows you to configure temperature measurement & calibration related settings of the meter.

## Temperature Setting Page



Figure 13 : Temperature Settings Page

Parameter	Description	Factory Default
Unit	Sets the unit of measurement for temperature. Available units: °C and °F	°C
Mode	Sets the temperature compensation mode. ATC – Automatic Temperature Compensation MTC – Manual Temperature Compensation	ATC

☞ Press ▲ (Up) or ▼ (Down) arrow key to change unit of measurement and temperature compensation mode.

# 2. Temperature Calibration

## 2.1 About Temperature Calibration

It is important to ensure that temperature calibration is carried out prior to pH, conductivity and DO calibration since temperature readings affect the accuracy of pH, conductivity and DO measurements. You need to perform temperature calibration only if the temperature value displayed on the meter is different from that of a calibrated thermometer or if cell constant setting is changed. A temperature offset calibration of  $\pm 5$  °C/ $\pm 9$  °F from the default reading is allowed for ATC mode.

The built-in temperature sensor of conductivity and DO probes are factory calibrated. **The built-in ATC probe of the conductivity cells can be used for temperature readout and compensation of the pH values.** DO in mg/L is dependent on temperature, so it is first necessary to calibrate or verify the temperature reading. Calibrate the probes only if you suspect temperature errors may have occurred over a long period of time or if you have a

replacement probe. This procedure offers offset adjustment of the probe to ensure more accurate temperature measurement.

Use a thermometer you are certain is accurate to measure the temperature of your sample.

## 2.2 Temperature Calibration for ATC mode

Make sure you have selected 'ATC' and the required unit of measurement ( $^{\circ}\text{C}$  or  $^{\circ}\text{F}$ ) in Temperature settings. Switch the meter on. Make sure the meter is in measurement mode.

1. Press **CAL (F2)** to go to calibration mode.

**Note:** If the meter is password protected, you will be prompted to enter a password. Refer to page 21- Accessing Calibration mode when password protection enabled.

2. The meter shows 'Calibration-Rinse Electrode' screen for few seconds and then shows the cell constant adjustment screen.
3. Press **NEXT (F3)** key. (For conductivity mode only. In pH mode, pressing this key will take you to the Report page)
4. Press **TEMP (F1)** to go to temperature calibration. The temperature calibration screen appears.

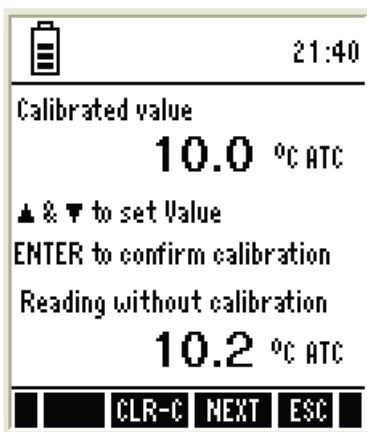

Figure 14 : Temperature Calibration Screen



1. The screen shows two readings. The upper display shows the temperature reading of the solution with respect to previous calibration (if any) & lower displays shows the temperature reading of the solution without any calibration (default reading). Use **▲** & **▼** keys to adjust the upper display to the temperature reading of the thermometer.

**Note:** The meter allows you to adjust the upper display reading up to  $\pm 5$   $^{\circ}\text{C}$  or  $\pm 9$   $^{\circ}\text{F}$ . (Calibration window)

2. Press **ENTER** key to confirm temperature value.

## 2.3 Temperature Calibration for MTC mode





Make sure you have selected 'MTC' and required unit of measurement (°C or °F) in Temperature settings. Switch on the meter. Make sure the meter is in measurement mode.

1. Press **CAL (F2)** to go to calibration mode.
2. The meter shows the 'Calibration-Rinse Electrode' screen for a few seconds and then shows the cell constant adjustment screen.
3. Press **NEXT (F3)** key. (For conductivity mode only. In pH mode, pressing this key will take you to the Report page)
4. Press **TEMP (F1)** to go to temperature calibration. The temperature calibration screen appears.
5. The screen shows two readings. The upper display shows the temperature reading of the solution with respect to previous calibration (if any) & lower displays shows the temperature reading of the solution without any calibration (default reading). Use  &  keys to adjust the upper display to the temperature reading of the thermometer.

**Note:** The meter allows you to adjust the upper display reading to any value within the measuring range -10.0 °C to 110.0 °C (14.0 °F to 230.0 °F).

6. Press **ENTER** key to confirm temperature value.

### Function Keys available in temperature calibration screen:

<b>NEXT (F3)</b>	Goes to measurement mode from where you entered calibration
<b>ESC (F4)</b>	Goes to measurement mode from where you entered calibration
<b>ENTER</b>	Confirms calibration
 	Increase/decrease temperature reading
 	(Not functional)

## 3. Temperature Measurement

There is no page in the meter dedicated to temperature measurement mode as the temperature is displayed with all other main parameters.

- END OF TEMPERATURE SECTION -

**pH**

## **PARAMETER GUIDE**

1. pH Setup Mode
2. pH Calibration Mode
3. pH Measurement Mode

**FOR MODELS :**

**pH 600/ 610/ 620**

**PC 650**

**PD 650**

**PCD 650**

# 1. pH Setup

pH setup sub-group allows you to configure pH measurement & calibration related settings of the meter. The settings are displayed in 2 pages. Press **NEXT-P (F2)** and **PREV-P (F1)** to navigate through these pages.

## pH Settings Page 1 – pH Measurement & Calibration

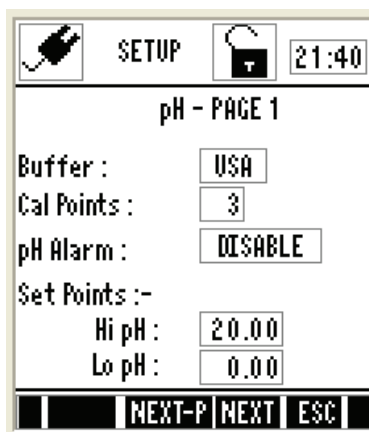

Figure 15: pH Settings Page 1 – pH Measurement & Calibration

This page allows you to set pH measurement & calibration related settings of the meter.

Parameter	Description	Factory Default
Buffer	Select your preferred pH standard buffer group for calibration & auto-recognition. Available groups: USA, NIST, DIN, PWB & USER Select 'USER' if you need to use a custom buffer for calibration.	USA
Cal points	Select the number of calibration points you intend to calibrate the meter using the selected buffer group. Available points: depends on the selected buffer group	3
Alarm Set Point	ENABLE – The measurement screen shows HI or LO alarm indicators when the meter reading is above 'HI alarm value' or below 'LO alarm value' specified in HI pH & LO pH parameters (below) DISABLE – HI and LO alarms are not shown in the LCD	DISABLE
Hi pH	Specify Hi alarm value here. The Hi alarm occurs when the pH reading goes above this value Available range: Hi pH (specified below) to 20.00 (This parameter is not editable when 'ALARM SET POINT' is disabled)	20.00pH
Lo pH	Specify Lo alarm value here. The Lo alarm occurs when the pH reading goes below this value Available range: 0.00 to Lo pH (specified above) (This parameter is not editable when 'ALARM SET POINT' is disabled)	0.00pH

## pH Settings Page 2 – Calibration Due Alarm & pH Resolution

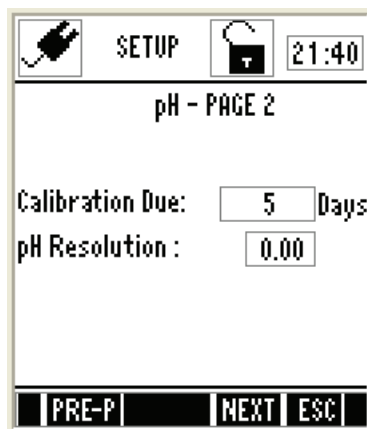

Figure 16: pH Settings Page 2 – Cal-due Alarm & pH Resolution

Parameter	Description	Factory Default
pH Calibration Due	Specify number of days for the pH calibration alarm. The meter shows CAL DUE indicator after calibration due days are passed from the last calibration date. Available range: 0 to 30	5 Days
pH Resolution	Sets the resolution for pH measurement Available range: 0.1, 0.01, 0.001	0.00

☞ Press ▲ (Up) or ▼ (Down) arrow key to change pH measurement & calibration related settings of the meter.

## 2. pH Calibration

### 2.1 About pH Calibration

When you re-calibrate your meter, previous pH calibration points are replaced on a point by point basis. For example, if you previously calibrated your meter at pH 4.01, 7.00, and 10.01, and you have now re-calibrated at pH 7.00, the meter retains the old calibration data at pH 4.01 and pH 10.01. The meter shows previously calibrated points in the display when the meter is in pH measurement mode. To completely re-calibrate the meter, or when you use a replacement probe, it is best to clear the previous calibration and re-calibrate the meter at all points.

The meter supports four internationally recognized standard buffer groups: USA, NIST, DIN & PWB. The default buffer group is USA.

The meter is capable of calibrating up to 6 points, depending on the standard buffer selected. When completely re-calibrating the meter, the first point of calibration should be one of the following, depending on your choice of standard buffer group.

Buffer Group	First Point of Calibration (when complete re-calibration)	Other Available Calibration Points
USA	pH 7.00	pH 1.68, 4.01, 10.01, and 12.45
NIST	pH 6.86	pH 4.01, 6.86, 9.18, and 12.45
DIN	pH 6.79	pH 1.09, 3.06, 4.65, 9.23, and 12.75
PWB	pH 6.97	pH 4.10

**Table 1: Buffer Groups and Calibration Points**

The meter automatically recognizes and calibrates to these standard pH buffer values, which makes pH calibration faster and easier.

## 2.2 pH buffer group for calibration and auto-recognition

This option allows you to choose a buffer group from four internationally recognized standard buffer groups namely USA, NIST, DIN & PWB. The default buffer group is USA. Refer to the 'pH Setup' section (pH Parameter guide) for information on how to set the meter to a particular buffer group.

### 2.2.1 pH Calibration points

This option allows you to calibrate up to 6 points, depending on the standard buffer selected. Or you can choose to have custom buffers with 2 to 5 points. When completely re-calibrating the meter, the first point of calibration should be one of the following, depending on your choice of standard buffer group. The meter automatically recognizes and calibrates to the standard pH buffer values, which makes pH calibration faster and easier.

## 2.3 pH Calibration with a Standard Buffer

Make sure you have selected a standard buffer with which you intend to perform pH calibration.

### 2.3.1 To start pH Calibration:

1. Switch the meter on and make sure the meter is in pH measurement mode.
2. Press **CAL (F2)** to start calibration.

**Note:** If the meter is password protected, you will be prompted to enter a password. Refer 3.4.1 on page 21.

3. The meter shows the 'Calibration-Rinse Electrode' screen for a few seconds and then shows the pH calibration screen.

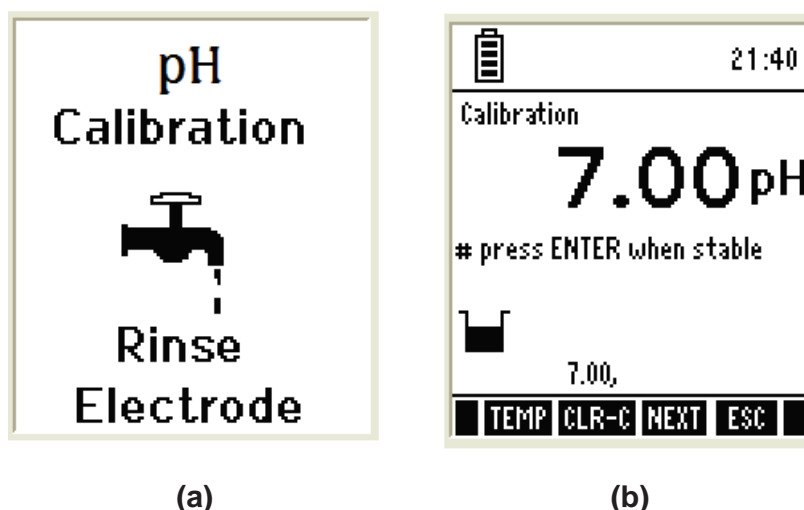

Figure 17: pH Calibration Screens

- Rinse the electrode in clean water and prepare electrode for calibration.

**Note:** If you wish to completely re-calibrate the meter, you need to clear previous calibration data. Press **CLR-C (F2)** key to clear previous calibration. The meter shows your confirmation screen. Press **ENTER** key to confirm deleting previous calibration. Once cleared, you need to calibrate the first point that corresponds to your selected buffer group.

- Dip the probe in calibration buffer. The tip of the probe must be completely immersed into the solution. Stir the probe gently to create a homogeneous solution.
- The display shows the pH reading. The meter scans through all the available (un-calibrated) points for the selected buffer group until it finds a close match within its acceptable calibration window. Once a match is found, the display shows the 'Stable' indicator.
- Press **ENTER** key to confirm the calibration.
- Rinse the probe with clean water.
- Place it in the next buffer and follow steps 5 and 7 to calibrate other points.

**Function Keys available in pH Calibration mode:**

<b>TEMP (F1)</b>	Goes to temperature calibration
<b>CLR-C (F2)</b>	Clears previous calibration (if any) after ENTER key is pressed in confirmation screen
<b>NEXT (F3)</b>	Shows calibration report
<b>ESC (F4)</b>	Exits from calibration and goes back to pH measurement mode
<b>ENTER</b>	Confirms the calibration
<b>▲ ▼ ◀ ▶</b>	(Not functional)

## 2.4 pH Calibration with a User-defined Buffer

If you selected 'USER' (Custom) buffer in the pH Setup, the following screen is shown when you enter calibration mode. You need to prepare at least 2 custom buffers of known pH values.

**Note:** Custom buffer solution values should be at least **1 pH** unit apart from each other. Otherwise, the meter will not accept the buffer values.

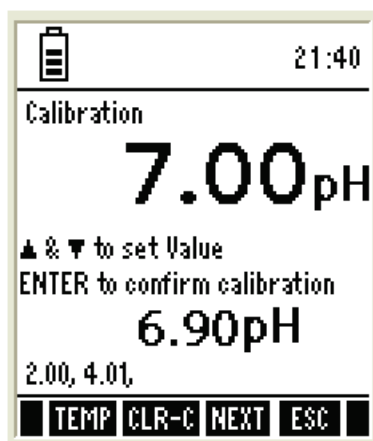

Figure 18 : User-define Buffer Screen

1. Rinse the electrode in clean water and prepare electrode for calibration.

**Note:** If you wish to completely re-calibrate the meter, you need to clear previous calibration data. Press **CLR-C (F2)** key to clear previous calibration. The meter shows you confirmation screen. Press **ENTER** key to confirm deleting previous calibration.

2. Dip the probe in custom calibration buffer. The tip of the probe must be completely immersed into the solution. Stir the probe gently to create a homogeneous solution.
3. The screen shows 2 readings. The upper display shows the pH reading of the solution with respect to previous calibration (if any) & lower display shows the pH reading of the solution without any calibration. Use ▲ & ▼ keys to adjust the upper display to the pH value of your custom buffer.
4. Press **ENTER** key to confirm the calibration.
5. Rinse the probe with clean water. Place it in the next buffer and follow steps 2, 3 and 4 to calibrate other points.

### Function Keys available in pH Calibration mode:

<b>TEMP (F1)</b>	Goes to temperature calibration
<b>CLR-C (F2)</b>	Clears previous calibration (if any) after ENTER key is pressed for the confirmation screen
<b>NEXT (F3)</b>	Shows calibration report

<b>ESC (F4)</b>	Exits from calibration and goes back to pH measurement mode
<b>ENTER</b>	Confirms the calibration
<b>▲ ▼</b>	Increases/decreases pH buffer reading
<b>◀ ▶</b>	(Not functional)

## 2.5 Calibration Report

Calibration report gives you detailed information on calibration. It includes date & time, buffer group, offset, temperature, number of days calibration is over due and slope information.

### 2.5.1 To View Calibration Report:

1. From pH measurement mode, press left **◀** or right **▶** arrow key to navigate to other available functions until you see **REPO** function in the LCD.
2. Press **REPO (F2)** key. The first page of calibration report is shown in the display.
3. Press **PAGE (F1)** to view the second page of the report.
4. Press **PRIN (F2)** to transfer the calibration report to computer through IrDA.

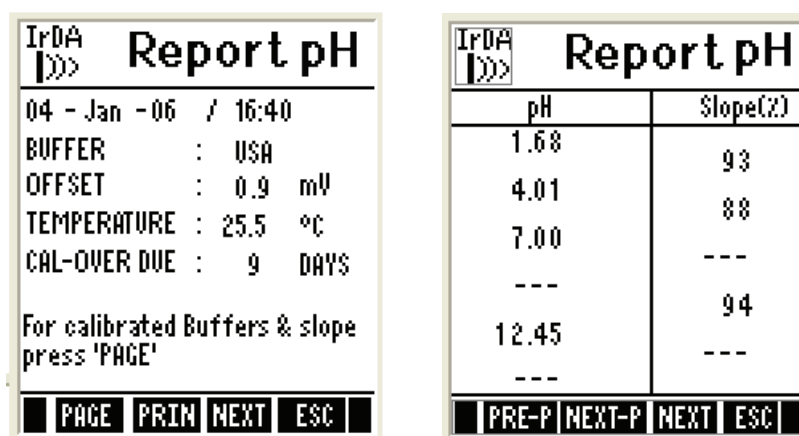

Figure 19: pH Calibration Report

**Example:** In the given pH calibration report, 4-point calibration has been done for USA buffer group (pH 1.68, pH 4.01, pH 7.00 & pH 12.45).

- The slope is 93 for the range enveloped from pH 1.68 to pH 4.01.
- The slope is 88 for the range enveloped from pH 4.01 to pH 7.00.
- The slope is 94 for the range enveloped from pH 7.00 to pH 12.45 where pH 10.01 calibration point has been skipped.

#### Function Keys available in pH calibration report screen:

<b>PAGE (F1)</b>	Goes to the second page of the calibration report
<b>BACK (F1)</b>	Goes to the first page of the calibration report
<b>PRIN (F2)</b>	Transfers calibration report to Computer through IrDA

<b>NEXT (F3)</b>	Goes to pH measurement mode
<b>ESC (F4)</b>	Goes to pH measurement mode
<b>ENTER</b>	(Not functional)
<b>▲ ▼ ◀ ▶</b>	(Not functional)

## 2.6 Average Slope Indicator of pH Probe

Each time you perform pH calibration; the meter calculates the average slope of your probe and graphically indicates it in the header section of the LCD screen.

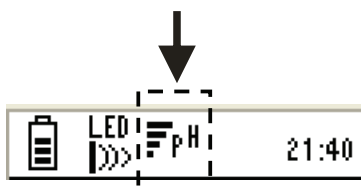

Figure 20 : Average Slope Indicator

Number of bars in the indicator shows the slope value:

Number of Bars	Average Slope of the pH Probe
4	Above 90%
3	90% to 80%
2	80% to 70%
1	Below 70%

## 3. pH Measurement Mode

### 3.1 Resolution of pH Reading

By default, the resolution is set to 0.00. You can change the resolution in the setup mode. pH resolution can be adjusted from 0.0 to 0.000 pH.

### 3.2 Indicators in pH measurement screen

In pH measurement mode, the meter displays pH and temperature reading.

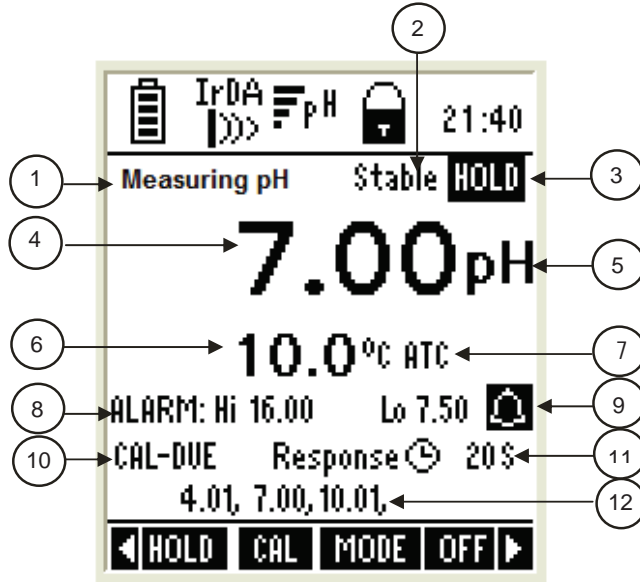

Item	Description
1	Measurement mode indicator
2	Appears when the reading is stable
3	Appears when the reading is on hold
4	pH reading
5	Units of measurement
6	Temperature reading & units
7	Temperature compensation mode
8	pH HI & LO Alarm limits
9	pH Alarm indicator
10	Calibration Due indicator
11	Response time of the pH probe
12	Calibrated Points

- END OF pH SECTION -

**mV**

## **PARAMETER GUIDE**

1. mV Setup Mode
2. mV Calibration Mode
3. mV Measurement Mode

**FOR MODELS :**

**pH 600/ 610/ 620**

**PC 650**

**PD 650**

**PCD 650**

## 1. mV Setup Mode

There is no setup mode for mV parameter.

## 2. mV Calibration Mode

### 2.1 mV Calibration with a Standard ORP Calibration Solution

Use a standard ORP solution of known value for calibration. You need to calibrate only 1-point.

1. Switch the meter on. Make sure the meter is in mV measurement mode.
2. Press **CAL (F2)** to go to calibration mode.

**Note:** If the meter is password protected, you will be prompted to enter a password.

3. The meter shows the 'Calibration-Rinse Electrode' screen for a few seconds and then shows the mV calibration screen.

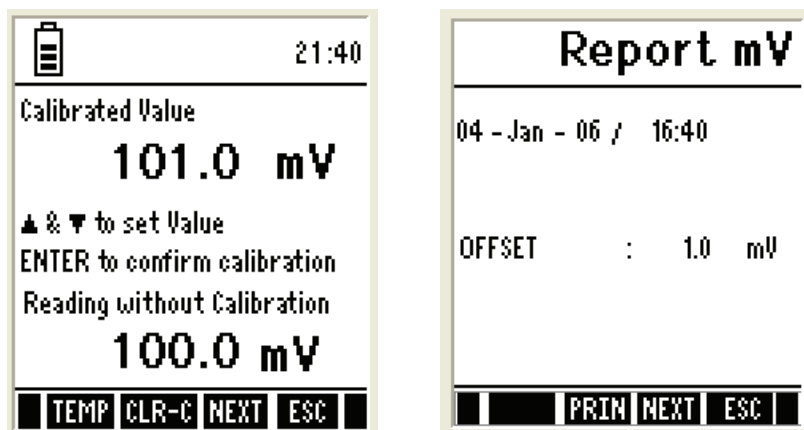

Figure 21 : mV Calibration Screen & Calibration Report

4. The screen shows two readings. The upper display shows the mV reading of the solution with respect to previous calibration (if any) & lower displays shows the absolute mV reading of the solution without any calibration (default reading). Use ▲ & ▼ keys to adjust the upper display to the mV value of the solution.

**Note:** The meter allows you to adjust the upper display reading up to  $\pm 150$  mV with respect to the default reading.

5. Press **ENTER** key to confirm the entered value.
6. The calibration is completed. The meter shows the calibration report.

7. Press **ESC (F4)** to go to measurement mode. The meter shows the relative mV reading of the solution in measurement mode, if offset is not zero.

**Note:** The function of the keys available on the mV calibration/ report screen is same as previously described in pH calibration with a user-defined buffer section.

## 2.2 Calibration Report

Calibration report gives you information on calibration. It includes date & time on which the last calibration was done and the offset.

### 2.2.1 To View Calibration Report:

1. From mV measurement mode, press left **◀** or right **▶** arrow key to navigate to other available functions until you see **REPO** function in the LCD
2. Press **REPO (F2)** key. The calibration report is shown in the display.
3. Press **PRIN (F2)** to transfer the calibration report to the computer.

## 3. mV Measurement Mode

In mV measurement mode, the meter displays mV and temperature reading. Depending on application, you can connect a suitable ORP probe to the meter or use the pH probe.

### 3.1 Indicators in mV measurement mode

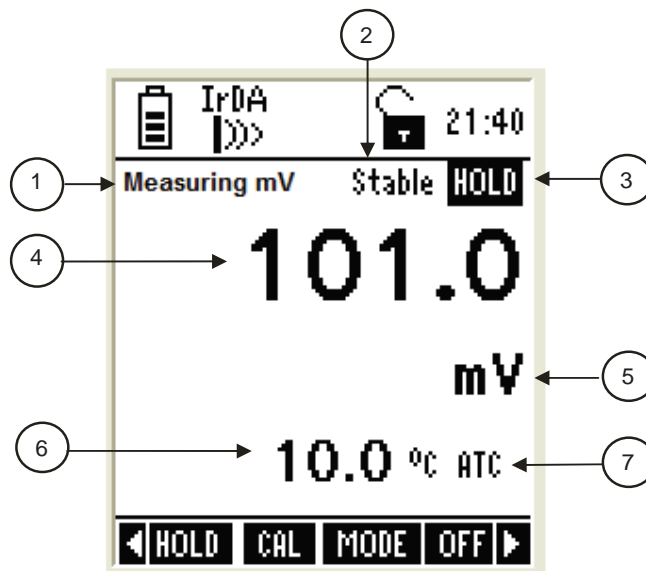

Figure 22 : mV Measurement Screen

Item	Description
1	Measurement mode indicator
2	Appears when the reading is stable
3	Appears when the reading is on hold
4	mV reading
5	Units of measurement
6	Temperature reading & units
7	Temperature compensation mode

**Note:** If offset is not zero, the meter displays relative mV reading of the solution in measurement mode.

- END OF mV SECTION -

# **ION**

## **PARAMETER GUIDE**

1. Ion Setup Mode
2. Ion Calibration Mode
3. Ion Measurement Mode

### **FOR MODELS :**

**pH 620**

**PC 650**

**PD 650**

**PCD 650**

# 1. Ion Setup

Ion setup sub-group allows you to configure Ion measurement & calibration related settings of the meter.

## Ion Settings Page



Figure 23: Ion Settings Page

Parameter	Description	Factory Default
Ion unit	Sets the unit of measurement for Ion. Available units: ppm, molar and mg/L	ppm

☞ Press ▲ (Up) or ▼ (Down) arrow key to change the value of a selected parameter.

# 2. Ion Calibration Mode

## 2.1 About Ion Calibration

The meter supports Ion calibration up to 8 points with minimum of 2-points. The available 8-points are 0.001, 0.01, 0.1, 1, 10, 100, 1000 & 10000.

The meter guides you through the calibration process with on-screen instructions and hints. If the second point and subsequent points are not within the allowable calibration window (15mV/decade to 90mV/decade), the meter will not accept the calibration.

When you try to re-calibrate the meter with ISE, the meter gives you 2 options:

- **Clear the previous calibration** (choose this if you wish to delete all previously calibrated points and re-calibrate with a new type of Ion)
- **Retain the previous calibration** (choose this if you wish to retain previously calibrated points and re-calibrate new points or overwrite existing points with same type of Ion).

Use standard solutions of 0.001, 0.01, 0.1, 1, 10, 100, 1000 & 10000 ppm for calibration. You need to calibrate minimum of 2-points. See “For Ion” under “Preparing the Meter for Calibration” on page 18.

1. Switch on the meter. Make sure the meter is in Ion measurement mode.
2. Press **CAL (F2)** to go to calibration mode.

**Note:** If the meter is password protected, you will be prompted to enter a password.

3. The meter shows the ‘Calibration-Rinse Electrode’ screen for a few seconds and then shows the Ion calibration screen.

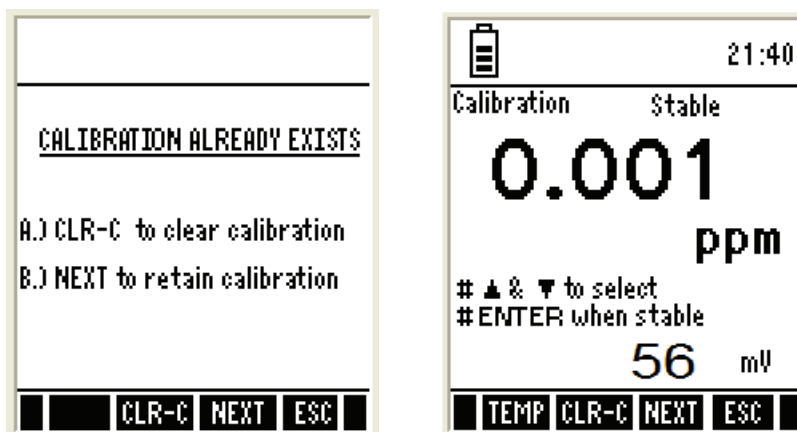

Figure 24 : Ion Calibration Screens

**Note:** If there is an existing ion calibration in the meter, you will be given two options:

- **Clear the previous calibration (CLR-C)** – choose this if you wish to delete all previously calibrated points and re-calibrate with a new type of ion.
- **Retain the previous calibration (NEXT)** – choose this if you wish to retain previously calibrated points and re-calibrate new points (or overwrite existing points) with same type of ion.

4. Dip the ISE in calibration solution. The tip of the probe must be completely immersed into the solution. Stir the probe gently to create a homogeneous solution.
5. The calibration screen displays two readings. The upper display shows the lowest calibration point 0.001 ppm. The lower display shows the absolute mV reading of the solution without any calibration (default reading). Use ▲ & ▼ keys to select the required calibration point in the upper display.
6. Allow time for the reading to stabilize. Press **ENTER** key to confirm the selected point. The meter flashes the upper display to acknowledge the first point calibration.

7. The upper display shows the next calibration point.
8. Rinse the ISE with clean water. Place it in the next calibration solution and follow the steps 4 through 6 to calibrate other points.

**Note:** The meter accepts the second and subsequent points only if the mV readings are within the calibration window (**15mV/decade to 90mV/decade**).

9. Press **ESC (F4)** to go to measurement mode.

**Note:** The function of the keys available on the Ion calibration/ report screen is same as previously described in pH calibration with a user-defined buffer section.

## 2.2 Calibration Report



Calibration report gives you detailed information on calibration. It includes date & time, calibration points (Ion concentrations), absolute mV reading for each point and slope.

Concen	mV	Slope mV
0.001	---	---
0.01	0.0	56
0.1	56.0	---
1	---	50
10	156.0	---
100	---	---
1000	---	---
10000	---	---

Figure 25 : Ion Calibration Report

**Example:** In the given Ion calibration report, calibration has been done for 0.01, 0.1 & 10 Ion concentrations. The corresponding absolute mV readings are 0.0mV, 56.0mV & 156mV. The slope is 56 mV/decade for the range enveloped from 0.01 to 0.1 ppm. Similarly, the slope is 50 for the range enveloped from 0.1 to 10ppm where 0.1 calibration point has been skipped.

### 2.2.1 To View Calibration Report

1. From ION measurement mode, press left  or right  arrow key to navigate to other available functions until you see **REPO** function in the LCD
2. Press **REPO (F2)** key. The calibration report is shown in the display.
3. Press **PRIN (F2)** to transfer the calibration report to computer through IrDA.

### 3. Ion Measurement Mode

In Ion measurement mode, the meter displays Ion concentration (in ppm, molar or mg/L) and mV reading. Depending on application, you can connect a suitable Ion Selective Electrode (ISE) to the meter.

#### 3.1 Changing unit of measurement

By default the measuring unit is ppm. You can select either molar or mg/L in the setup mode.

#### 3.2 Indicators in Ion measurement mode

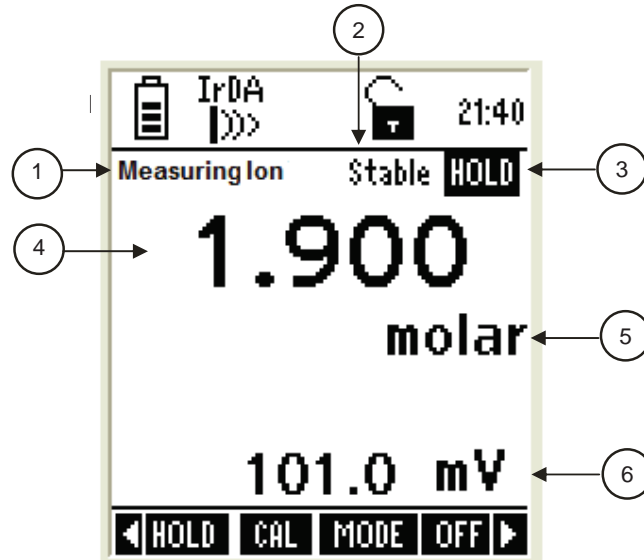

Item	Description
1	Measurement mode indicator
2	Appears when the reading is stable
3	Appears when the reading is on hold
4	Ion reading
5	Units of measurement
6	mV reading

**Note:** If ion calibration has not been done, the display shows '- - -'.

- END OF ION SECTION -

## **CONDUCTIVITY**

# **PARAMETER GUIDE**

1. COND Setup Mode
2. COND Calibration Mode
3. COND Measurement Mode

## **FOR MODELS :**

**COND 600/610**

**PC 650**

**CD 650**

**PCD 650**

# 1. Conductivity Setup

Conductivity setup screen present many options to control the operating parameters, which can be controlled and set from the conductivity setup screen. The settings are displayed in 2 pages. Press **NEXT-P (F2)** and **PREV-P (F1)** to navigate through these pages.

## Conductivity Settings Page 1 – Operating Parameters

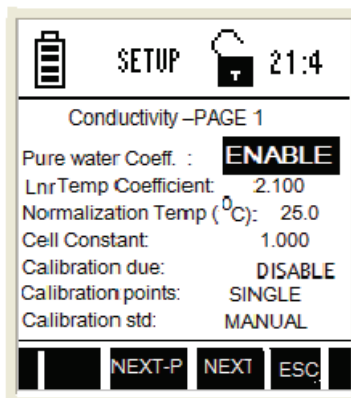

Figure 27 : Conductivity Settings Page 1 – Operating Parameter

This page allows you to set operating parameters for the conductivity measurement mode:

Parameter	Description	Factory Default
Pure water Coeff.	Pure water coefficient will be calculated and applied automatically for ultra pure water measurement if enabled.	ENABLE
Lnr Temp Coefficient	Specify temperature coefficient to measure temperature corrected conductivity	2.100
Normalization Temp	Select a default temperature that the meter will use along with the temperature coefficient to calculate a temperature corrected conductivity measurement.	25
Cell Constant	Select the appropriate cell constant of the conductivity cell. Available cell constants: 0.1 to 10	1.000
Calibration due	Specify number of days for the Conductivity calibration alarm. The meter shows CAL DUE indicator after calibration date. Available range : 0 to 30 (if enabled)	DISABLE
Calibration points	<b>Single</b> - In single point calibration one calibrated conductivity value can be used for the entire 5 conductivity ranges. <b>Multi</b> - In multi point calibration, you can calibrate one point in each of the measuring ranges (up to 5 points.)	Single
Calibration mode	<b>AUTO</b> - In the automatic calibration mode, the meter automatically detects and verifies the appropriate known calibration standards solutions. <b>Manual</b> - In the manual calibration, you can manually input the appropriate values as your desired calibration standards in each specific range.	Auto

**Note:** 1. If pure water coefficient is set to 'ENABLE', the meter will apply pure water compensation automatically below 2  $\mu\text{S}$  and switch back to linear compensation for above 2  $\mu\text{S}$ .

2. If pure water coefficient is set to 'DISABLE', Lnr Temp Coefficient applies throughout the measurement.

### Conductivity Settings Page 2 – Hi-Lo Set Points

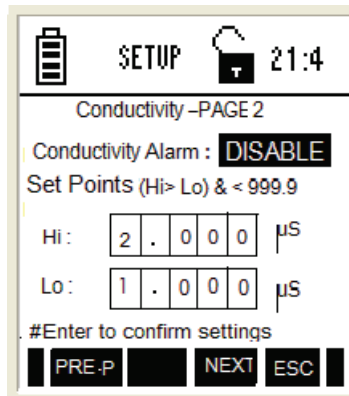



Figure 28 : Conductivity Settings Page 2 – Hi-Lo Alarm

 This page allows you to set alarm limits for the conductivity measurement mode. A visual alarm symbol will appear on the screen, if the conductivity value of the measurement is outside of the boundaries set by the minimum and maximum limits.

Parameter	Description	Factory Default
Alarm Set Points	Set alarm limits for the conductivity measurement mode: ENABLE – The measurement screen shows HI or LO alarm indicators when the meter reading is above 'HI alarm value' or below 'LO alarm value' specified in HI & LO $\mu\text{S}$ parameters (below) DISABLE – HI and LO alarms are not shown in the LCD	DISABLE
Hi $\mu\text{S}$	Specify Hi alarm value here. The Hi alarm occurs when the conductivity reading goes above this value Available range: Hi $\mu\text{S}$ (specified below) to 2.000 $\mu\text{S}$ (This parameter is not editable when 'ALARM SET POINT' is disabled)	2.000 $\mu\text{S}$
Lo $\mu\text{S}$	Specify Lo alarm value here. The Lo alarm occurs when the conductivity reading goes below this value Available range: 1.00 $\mu\text{S}$ to Hi $\mu\text{S}$ (specified above) (This parameter is not editable when 'ALARM SET POINT' is disabled)	1.000 $\mu\text{S}$

## 2. Conductivity Calibration Mode

### 2.1 Conductivity Calibration mode

This option allows you to select automatic or manual calibration standard. In the automatic calibration mode, the meter automatically detects and verifies the appropriate known calibration standards solutions before accepting these particular calibration standards as one of its calibration values in a specific measurement range. **Standard buffer values: 84.0 uS/ 1.413 mS/ 12.88 mS/ 111.8 mS**

In the manual calibration, non-standard calibration values can be used for calibration. You can manually input the appropriate values as your desired calibration standards in each specific range. The selected calibration standard will be displayed at the bottom of screen (See Figure 3 below).

#### 2.1.1 Conductivity calibration points

This option allows you to select single or multi point calibration. Single point calibration refers to calibrating one conductivity value and uses it for the entire 5 conductivity ranges. In multi point calibration, you can calibrate one point in each of the measuring ranges (up to 5 points). The selected calibration point will be displayed in the bottom of screen. For example: If single point calibration is selected it will display 'SPC' at the bottom of the screen, as shown in this diagram:



Figure 29 : Calibration Standard & Point Indicator

But if a multi-point calibration option (calibration for different ranges are indicated in the Technical Specifications where calibration factors are applied only to their respective ranges.

### 2.2 Cell constant

This option lets you adjust the cell constant of the conductivity cell that you are using. Cell constant can be adjusted from 0.010 to 10.000. k

### 2.3 Normalization Temperature (°C)

This option will allow you to select a normalized temperature that the meter will use to normalize its conductivity measurements to a standard temperature.

**NOTE:** The factory default value for normalization temperature is 25 °C.

### 2.4 Linear Temperature Coefficient

The temperature coefficient is a value that reflects the degree to which the conductivity is affected by temperature changes.

**NOTE:** Your meter is factory set to a temperature coefficient of 2.1% per °C.

## 2.5 Pure Water Coefficient

Pure water coefficient will be calculated and applied automatically for ultra pure water measurement if you select 'ENABLE' at appropriate set up pages.

## 2.6 To begin Calibration

Make sure you have selected a standard solution with which you intend to perform conductivity calibration.

**Follow this procedure:**

1. Switch on the meter and make sure the meter is in conductivity measurement mode.
2. Dip the probe into the calibration standard. Immerse the probe tip beyond the upper steel band. Stir the probe gently to create a homogeneous sample. Allow time for the reading to stabilize.
3. Press **CAL (F2)** to start calibration.

**Note:** If the meter is password protected, you will be prompted to enter a password.

4. The meter shows the 'Calibration-Rinse Electrode' screen for a few seconds to prompt user to rinse electrode with de-ionized water before calibration.

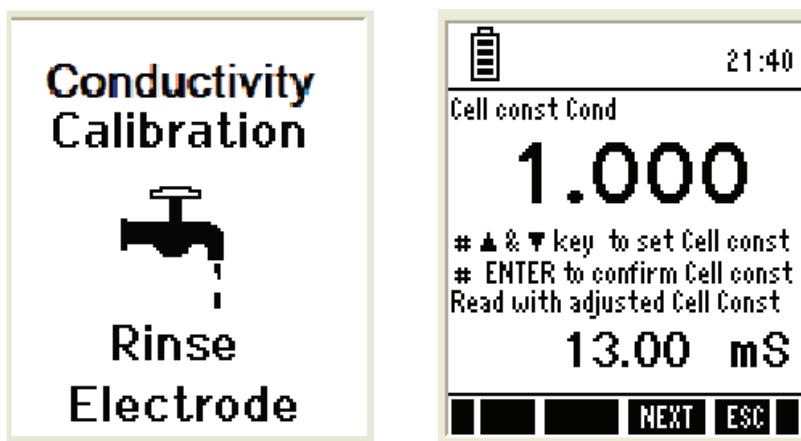

Figure 30 : Calibration Screens

5. The meter then shows cell constant adjustment screen. The upper display shows the cell constant of the conductivity cell & lower display shows the measured value of the solution with adjusted cell constant with respect to default calibration. Press ▲ & ▼ keys to adjust the cell constant for your custom solution in upper display.
6. Press **ENTER** key to confirm the cell constant.

## 2.7 Manual Calibration

**Note:** If you wish to completely re-calibrate the meter, you need to clear previous calibration data. Press **CLR-C (F2)** key to clear previous calibration. The meter shows you confirmation screen. Press **ENTER** key to confirm deleting previous calibration.

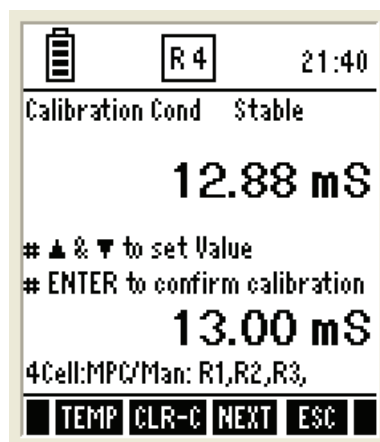

Figure 31 : Conductivity Calibration Screen

1. The upper display shows the conductivity reading of the solution with respect to previous calibration (if any) & lower display shows the conductivity reading of the solution without any calibration. Use ▲ & ▼ keys to adjust the upper display of the conductivity value of your custom solution.
2. Press **ENTER** key to confirm the calibration.
3. Press **ESC (F4)** to go to measurement mode.
4. For **multi point calibration**, select multi point in Setup page to calibrate.

### Function Keys available in Conductivity Calibration mode:

<b>TEMP (F1)</b>	Goes to temperature calibration
<b>CLR-C (F2)</b>	Clears previous calibration (if any) after ENTER key is pressed in confirmation screen
<b>NEXT (F3)</b>	Shows calibration report
<b>ESC (F4)</b>	Exits from calibration and goes back to conductivity measurement mode
<b>ENTER</b>	Confirms the calibration
▲ ▼	Increases/decreases conductivity cell reading
◀ ▶	(Not functional)

## 2.8 Automatic Calibration (For Conductivity Calibration)

In the Automatic Calibration mode, the meter is capable of accepting either single-point or up to 4 points for multi-point calibration with a maximum of 1 point per specific measurement range. Select automatic calibration mode in the Conductivity Setup screen. Press **(F2)** to start calibration and the meter displays cell adjustment screen as mentioned in the above section.

The following screen is displayed after cell adjustment screen, if you have selected '**Auto**' in Calibration mode and '**MULTI**' in Calibration Point:

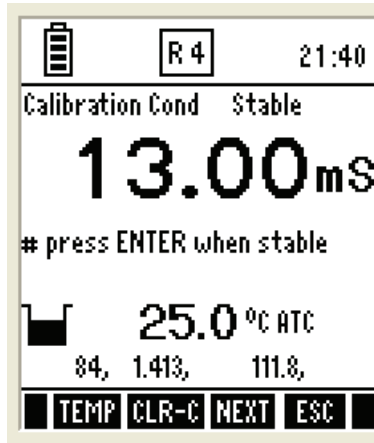

Figure 32 : Conductivity Calibration Screen – Auto

1. Rinse the electrode in de-ionized water and prepare electrode for calibration.

**Note:** If you wish to completely re-calibrate the meter, you need to clear previous calibration data. Press **CLR-C (F2)** key to clear previous calibration. The meter shows you confirmation screen. Press **ENTER** key to confirm deleting previous calibration.

2. Dip the probe into the calibration standard. Immerse the probe tip beyond the upper steel band. Stir the probe gently to create a homogeneous sample. Allow time for the reading to stabilize.
3. Press **CAL (F2)** to go to calibration mode. The screen shows conductivity reading. The meter scans through all the available points for the selected solution group until it finds a close match within its acceptable calibration window. Once a match is found, the display shows 'Stable' indicator.
4. Press **ENTER** key to confirm the calibration.
5. Rinse the probe with de-ionized water. Place it in the next solution and follow the steps 2, 3 and 4 to calibrate other points.

**Function Keys available in Conductivity Calibration mode:**

<b>TEMP (F1)</b>	Goes to temperature calibration
<b>CLR-C (F2)</b>	Clears previous calibration (if any) after ENTER key is pressed for the confirmation screen
<b>NEXT (F3)</b>	Shows calibration report
<b>ESC (F4)</b>	Exits from calibration and goes back to conductivity measurement mode
<b>ENTER</b>	Confirms the calibration
<b>▲▼◀▶</b>	Not functional



6. Press **ESC (F4)** to go to measurement mode.

**Note:** If the user has selected 'SINGLE' point calibration and 'AUTO' calibration mode, the meter will go to measurement mode after step 4.

## 2.9 Calibration Report

Calibration report gives you detailed information on calibration. It includes date & time, calibration points, range, factor and cell constant.

### 2.9.1 To View Calibration Report:



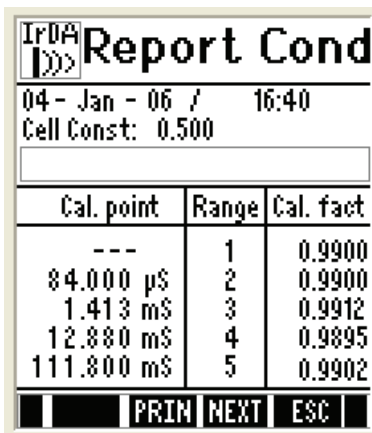

1. From conductivity measurement mode, press left  or right  arrow key to navigate to other available functions until you see **REPO** function in the LCD.
2. Press **REPO (F2)** key. The calibration report is shown in the display.
3. Press **PRIN (F2)** to transfer the calibration report to computer through IrDA.



Cal. point	Range	Cal. fact
---	1	0.9900
84.000 $\mu$ S	2	0.9900
1.413 mS	3	0.9912
12.880 mS	4	0.9895
111.800 mS	5	0.9902

Figure 33: Conductivity Calibration Report

#### Function Keys available in conductivity calibration report screen:

<b>PRIN (F2)</b>	Transfers calibration report to Computer through IrDA
<b>NEXT (F3)</b>	Goes to conductivity measurement mode
<b>ESC (F4)</b>	Goes to conductivity measurement mode
<b>ENTER</b>	(Not functional)
   	(Not functional)

**Note:** Auto calibration can also be done for electrode with cell constant 0.4 – 2.

## 3. Conductivity Measurement Mode

In conductivity measurement mode, the meter displays conductivity and temperature readings. The LCD shows related information for the conductivity measurement such as temperature compensation mode, stable indicator, probe condition, calibration points, response time of the conductivity probe and conductivity alarm conditions. You can customize or enable/disable some of these indicators in the Setup mode.

### 3.1 Indicators in Conductivity measurement screen

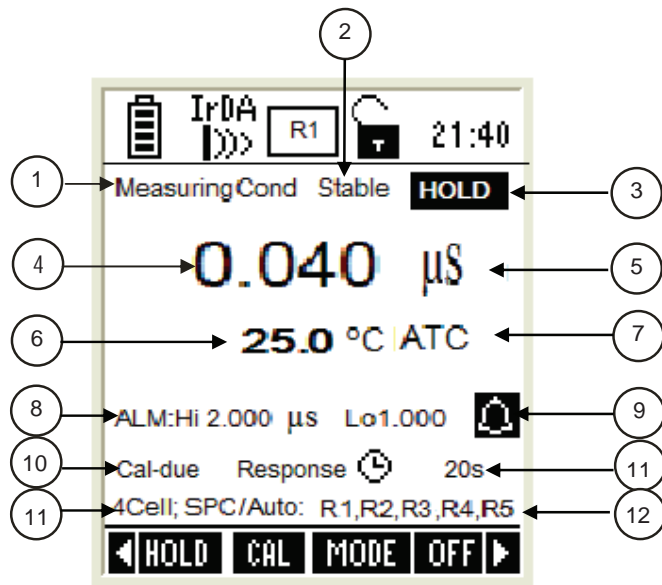

Figure 34 : Conductivity Measurement Screen

Item	Description
1	Measurement mode indicator
2	Appears when the reading is stable
3	Appears when the reading is on hold
4	Conductivity reading
5	Units of measurement
6	Temperature reading & units
7	Temperature compensation mode
8	Conductivity HI & LO Alarm limits
9	Conductivity Alarm indicator
10	Calibration Due indicator
11	Response time of the CON probe
12	Conductivity ranges (that have been calibrated)
13	Number of calibration points and method of calibration

**Note:** Lower display shows '2Cell' or '4Cell' when a 2-cell or 4-Cell conductivity probe is connected.

- END OF CONDUCTIVITY SECTION -

**TDS**

## **PARAMETER GUIDE**

- 1.TDS Setup Mode
- 2.TDS Calibration Mode
- 3.TDS Measurement Mode

**FOR MODELS :**

**COND 600/610**

**PC 650**

**CD 650**

**PCD 650**

# 1. TDS Setup

The TDS setup screen presents many options to control the operating parameters, which can be controlled and set from the TDS setup screen. The settings are displayed in 2 pages. Press **NEXT-P (F2)** and **PREV-P (F1)** to navigate through these pages.

## TDS Settings Page 1 – Operating Parameters

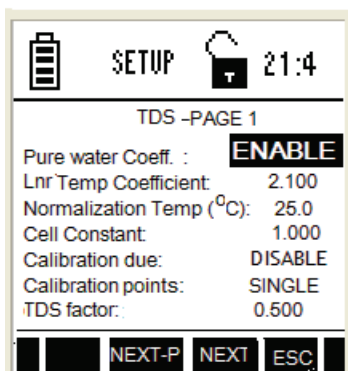

Figure 35 : TDS Settings Page 1 – Operating Parameters

This page allows you to set operating parameters for TDS measurement mode:

Parameter	Description	Factory Default
Pure water Coeff.	Pure water coefficient will be calculated and applied automatically for ultra pure water measurement if enabled.	ENABLE
Lnr Temp Coefficient	Specify temperature coefficient to measure temperature corrected conductivity	2.100
Normalization Temp	Select a default temperature that the meter will use along with the temperature coefficient to calculate a temperature corrected conductivity measurement.	25
Cell Constant	Select the appropriate cell constant of the conductivity cell. Available cell constants: 0.1 to 10	1.000
Calibration due	Specify number of days for the Conductivity calibration alarm. The meter shows CAL DUE indicator after calibration date. Available range : 0 to 30 (if enabled)	DISABLE
Calibration points	<b>Single</b> - In single point calibration one calibrated conductivity value can be used for the entire 5 conductivity ranges. <b>Multi</b> - In multi point calibration, you can calibrate one point in each of the measuring ranges (up to 5 points.)	Single
TDS factor	The TDS conversion factor is the number used by the meter to convert from conductivity to TDS. The TDS conversion factor automatically adjusts the reading. The TDS conversion factor can be set from 0.40 to 1.00	0.500

**Note:** A controlled temperature water bath is ideal for this procedure

## TDS Settings Page 2 – Hi-Lo Set Points

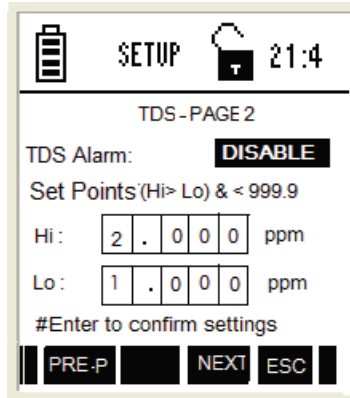

Figure 36 : TDS Settings Page 2 – Hi-Lo Set Points

This page allows you to set alarm limits for the TDS measurement mode:

Parameter	Description	Factory Default
Alarm Set Points	Set alarm limits for the TDS measurement mode: ENABLE – The measurement screen shows HI or LO alarm indicators when the meter reading is above 'HI alarm value' or below 'LO alarm value' specified in HI & LO ppm parameters (below) DISABLE – HI and LO alarms are not shown in the LCD	DISABLE
Hi ppm	Specify Hi alarm value here. The Hi alarm occurs when the TDS reading goes above this value  (This parameter is not editable when 'ALARM SET POINT' is disabled)	2.00 ppm
Lo ppt	Specify Lo alarm value here. The Lo alarm occurs when the TDS reading goes below this value  (This parameter is not editable when 'ALARM SET POINT' is disabled)	1.00 ppm

☞ Press ▲ (Up) or ▼ (Down) arrow key to set high or low alarm point.

## 2. TDS Calibration Mode

You can commence calibration in the TDS mode by using the conductivity calibration method and after setting the correct TDS factor. For the rest of the calibration process, follow steps as mentioned in the section on manual calibration. Use a standard solution of known value for calibration. Use the single-point standardization option to measure samples that are close in value and multi-point standardization to measure wide range of samples.

1. Switch the meter on. Make sure the meter is in TDS measurement mode.
2. Press **CAL (F2)** to go to calibration mode.

**Note:** If the meter is password protected, you will be prompted to enter a password.

3. The meter shows the 'Calibration-Rinse Electrode' screen a few seconds and then shows the cell constant adjustment screen for TDS.

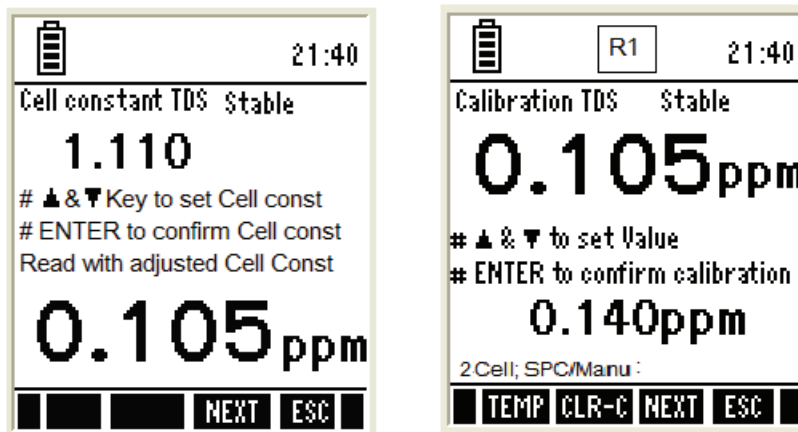

Figure 37 : TDS Cell Constant Adjustment & TDS Calibration Screen

4. The upper display of the TDS cell constant screen shows the cell constant of the cell & lower display shows the measured value of the solution with adjusted cell constant. Press ▲ & ▼ keys to adjust the cell constant for your custom solution in upper display.
5. Press **ENTER** key to confirm the entered value and to go to TDS calibration screen.
6. The screen shows two readings. The upper display shows the TDS reading of the solution with respect to previous calibration (if any) & lower display shows the TDS reading of the solution without any calibration. Use ▲ & ▼ keys to adjust the upper display of the TDS value of your custom solution.
7. Press **ENTER** key to confirm the entered value.

**Note:** The function of the keys available on the TDS cell constant/calibration/report screen is the same as previously described in the conductivity calibration section.

8. Rinse the probe with de-ionized water. Place it in the next solution and follow the steps 2 to 7 to calibrate other points, if 'MULTI' point calibration is selected.
9. Press **ESC (F4)** to go to measurement mode. The meter shows the TDS reading of the solution in measurement mode.

## 2.1 TDS Calibration Report

Calibration report gives you information on calibration. It includes date & time of the last calibration and the cal factor.

### 2.1.1 To View Calibration Report:

1. From TDS measurement mode, press left ◀ or right ▶ arrow key to navigate to other available functions until you see **REPO** function in the LCD.
2. Press **REPO (F2)** key to go to calibration report screen.
3. Press **PRIN (F2)** to transfer the calibration report to the computer.

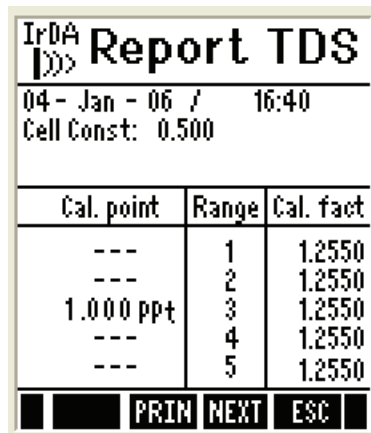

The screenshot shows a monochrome LCD display with the following content:

- Top line: IrDA
- Second line: Report TDS
- Third line: 04 - Jan - 06 / 16:40
- Fourth line: Cell Const: 0.500
- A table with three columns: Cal. point, Range, and Cal. fact.
- Bottom row: PRIN NEXT ESC

Cal. point	Range	Cal. fact
---	1	1.2550
---	2	1.2550
1.000 ppt	3	1.2550
---	4	1.2550
---	5	1.2550

Figure 38 : TDS Report Screen

## 3. TDS Measurement Mode

In TDS measurement mode, the meter displays TDS and temperature reading.

### 3.1 Indicators in TDS measurement mode

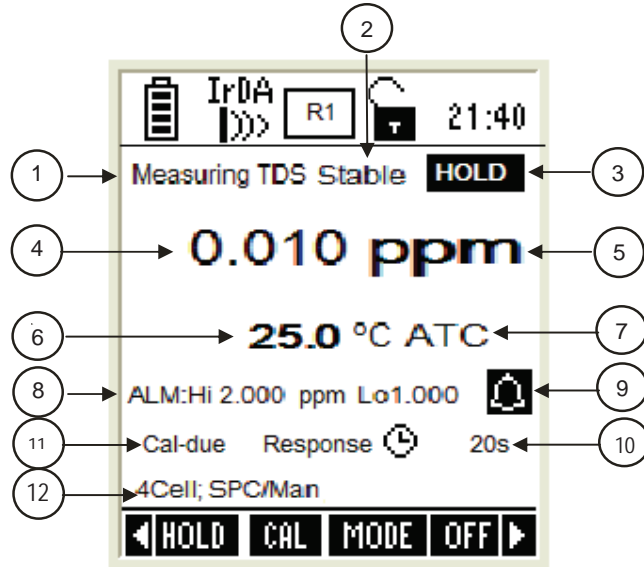

Item	Description
1	Measurement mode indicator
2	Appears when the reading is stable
3	Appears when the reading is on hold
4	TDS reading
5	Units of measurement
6	Temperature reading & units
7	Temperature compensation mode
8	TDS HI & LO Alarm limits
9	TDS Alarm indicator
10	Response time
11	Calibration Due indicator
12	Number of calibration points and method of calibration

**Note:** Lower display shows '2Cell' or '4Cell' when a 2-cell or 4-Cell conductivity probe is connected.

**Note:** The factory default setting for the TDS conversion factor is 0.50. If your solution has a different TDS factor, you can improve calibration accuracy by setting the TDS factor prior to calibration. After setting the correct TDS Factor, you can commence calibration in the TDS mode.

## 4. About TDS

### 4.1 Calculating TDS Conversion Factor

You can calibrate your meter using TDS calibration standard solutions. The calibration standard only needs to give the TDS value at a standard temperature such as 25 °C. To determine the conductivity-to-TDS conversion factor use the following formula:

$$\text{Factor} = \text{Actual TDS} \div \text{Actual Conductivity @ 25 °C}$$

#### Definitions:

**Actual TDS:** Value from the solution bottle label or as a standard you make using high purity water and precisely weighed salts.

**Actual Conductivity:** Value measured using a properly calibrated Conductivity/Temperature meter.

Both the Actual TDS and the Actual Conductivity values must be in the same magnitude of units. For example, if the TDS value is in ppm the conductivity value must be in  $\mu\text{S}$ ; if the TDS value is in ppt the conductivity value must be in mS.

Check your factor by multiplying the conductivity reading by the factor in the above formula. The result should be in TDS value.

### 4.2 Calculating Temperature Coefficients

To determine the temperature coefficient of your sample solution use this formula:

$$tc = 100 \times \frac{C_{T_2} - C_{T_1}}{C_{T_1}(T_2 - 25) - C_{T_2}(T_1 - 25)}$$

Where:

**tc** = Temperature coefficient      **25** = 25 °C

**C<sub>T1</sub>** = Conductivity at Temp 1      **C<sub>T2</sub>** = Conductivity at Temp 2

**T<sub>1</sub>** = Temp 1      **T<sub>2</sub>** = Temp 2

**Note:** A controlled temperature water bath is ideal for this procedure

1. Immerse the probe into a sample of your solution and adjust the temperature coefficient to 0%
2. Wait for 5 minutes. Note **T<sub>1</sub>** and **C<sub>T1</sub>** (conductivity at **T<sub>1</sub>**).
3. Condition the sample solution and probe to a temperature (**T<sub>2</sub>**) that is about 5 °C to 10 °C different from **T<sub>1</sub>**, and note the conductivity reading **C<sub>T2</sub>**.

**Note:** Record your results for future reference. Ideally **T<sub>1</sub>** and **T<sub>2</sub>** should bracket your measurement temperature, and should not differ by more than 5 °C.

- END OF TDS SECTION -

## **SALINITY**

# **PARAMETER GUIDE**

- 1.Salinity Setup Mode
- 2.Salinity Calibration Mode
- 3.Salinity Measurement Mode

## **FOR MODELS :**

**COND 610**

**PC 650**

**CD 650**

**PCD 650**

# 1. Salinity Setup

Salinity setup screen presents many options to control the operating parameters, which can be controlled and set from the salinity setup screen. The settings are displayed in 2 pages. Press **NEXT-P (F2)** and **PREV-P (F1)** to navigate through these pages.

## Salinity Settings Page 1 – Operating Parameters

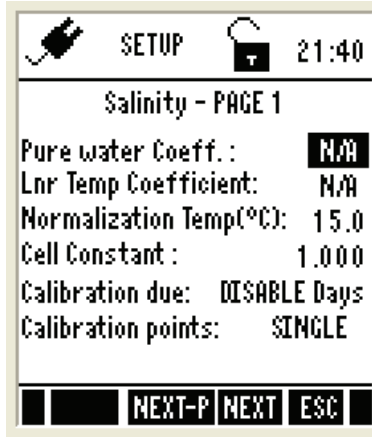

Figure 39: Salinity Settings - Page 1

This page allows you to set operating parameters for salinity measurement.

Parameter	Description	Factory Default
Pure water Coeff.	Pure water coefficient will be calculated and applied automatically for ultra pure water measurement if enabled.	ENABLE
Lnr Temp Coefficient	Specify temperature coefficient to measure temperature corrected conductivity	2.100
Normalization Temp	Select a default temperature that the meter will use along with the temperature coefficient to calculate a temperature corrected conductivity measurement.	25
Cell Constant	Select the appropriate cell constant of the conductivity cell. Available cell constants: 0.1 to 10	1.000
Calibration due	Specify number of days for the Conductivity calibration alarm. The meter shows CAL DUE indicator after calibration date. Available range : 0 to 30 (if enabled)	DISABLE
Calibration points	<b>Single</b> - In single point calibration one calibrated conductivity value can be used for the entire 5 conductivity ranges. <b>Multi</b> - In multi point calibration, you can calibrate one point in each of the measuring ranges (up to 5 points.)	Single

## Salinity Settings Page 2 – Hi-Lo Set Points

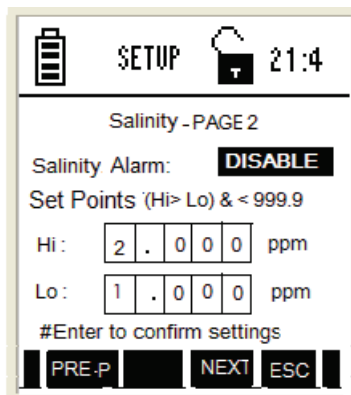

Figure 40: Salinity Settings Page 2 – Hi-Lo Set Points

This page allows you to set alarm limits for the salinity measurement mode:

Parameter	Description	Factory Default
Alarm Set Points	Set alarm limits for the salinity measurement mode: ENABLE – The measurement screen shows HI or LO alarm indicators when the meter reading is above 'HI alarm value' or below 'LO alarm value' specified in HI & LO ppm parameters (below) DISABLE – HI and LO alarms are not shown in the LCD	DISABLE
Hi ppm	Specify Hi alarm value here. The Hi alarm occurs when the salinity reading goes above this value	2.00 ppm
Lo ppt	Specify Lo alarm value here. The Lo alarm occurs when the salinity reading goes below this value  (This parameter is not editable when 'ALARM SET POINT' is disabled)	1.00 ppm

☞ Press ▲ (Up) or ▼ (Down) arrow key to set high or low alarm point.

## 2. Salinity Calibration Mode

Use a standard solution of known value for calibration. Use the single-point standardization option to measure samples that are close in value and multi-point standardization to measure wide range of samples.

1. Switch the meter on. Make sure the meter is in salinity measurement mode.
2. Press **CAL (F2)** to go to calibration mode.

**Note:** If the meter is password protected, you will be prompted to enter a password.

- The meter shows the 'Calibration-Rinse Electrode' screen for a few seconds and then shows the cell constant adjustment screen.

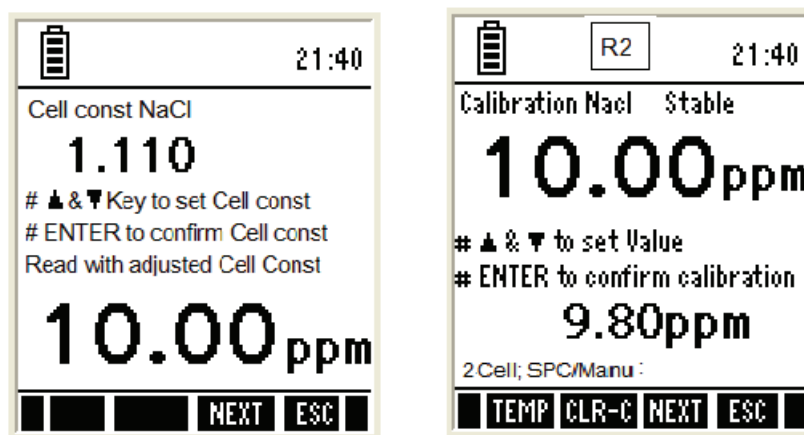

Figure 41 : Salinity Cell Constant & Salinity Calibration

- The upper display of the cell constant adjustment screen shows the cell constant of your cell and lower display shows the measured value of the solution with adjusted cell constant. Press **▲** & **▼** keys to adjust the cell constant for your custom solution in upper display.
- Press **ENTER** key to confirm the entered value and to go to salinity calibration screen.
- The screen shows two readings. The upper display shows the salinity reading of the solution with respect to previous calibration (if any) & lower display shows the salinity reading of the solution without any calibration. Use **▲** & **▼** keys to adjust the upper display of the salinity value of your custom solution.
- Press **ENTER** key to confirm the entered value.

**Note:** The function of the keys available on the salinity cell constant/calibration/ report screen is same as previously described in conductivity calibration.

- Rinse the probe with de-ionized water. Place it in the next solution and follow the steps 2 to 7 to calibrate other points, if 'MULTI' point calibration is selected.
- Press **ESC (F4)** to go to measurement mode. The meter shows the salinity reading of the solution in measurement mode.

## 2.1 Salinity Calibration Report

Calibration report gives you information on calibration. It includes date & time of the last calibration and the cal factor.

### 2.1.1 To View salinity Report:

1. From salinity measurement mode, press left ◀ or right ▶ arrow key to navigate to other available functions until you see **REPO** function in the LCD
2. Press **REPO (F2)** key. The calibration report is shown in the display.
3. Press **PRIN (F2)** to transfer the calibration report to the computer.

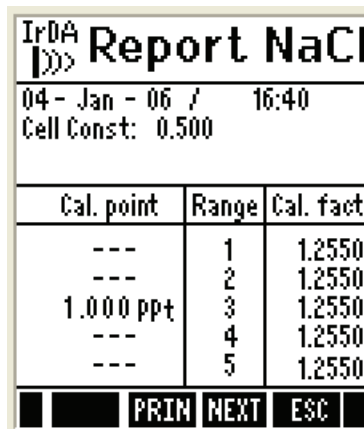

The image shows a monochrome LCD screen displaying a salinity calibration report. At the top, it reads 'IrDA' and 'Report NaCl'. Below this, it shows the date and time '04 - Jan - 06 / 16:40' and the cell constant 'Cell Const: 0.500'. A table follows with three columns: 'Cal. point', 'Range', and 'Cal. fact'. The table contains five rows of data. At the bottom of the screen, there are three buttons labeled 'PRIN', 'NEXT', and 'ESC'.

Cal. point	Range	Cal. fact
---	1	1.2550
---	2	1.2550
1.000 ppt	3	1.2550
---	4	1.2550
---	5	1.2550

Figure 42 : Salinity Report Screen

## 3. Salinity Measurement Mode

In Salinity measurement mode, the meter displays salinity and temperature reading.

### 3.1 Indicators in salinity measurement mode

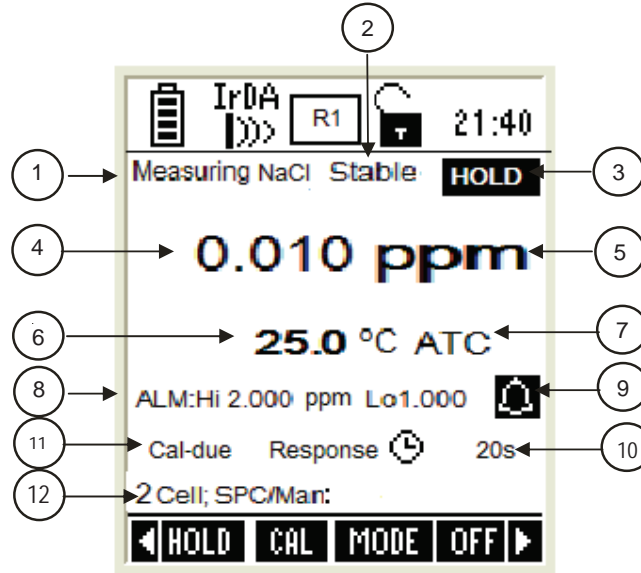

Figure 43 : Salinity Measurement Screen

Item	Description
1	Measurement mode indicator
2	Appears when the reading is stable
3	Appears when the reading is on hold
4	Salinity reading
5	Units of measurement
6	Temperature reading & units
7	Temperature compensation mode
8	Salinity HI & LO Alarm limits
9	Salinity Alarm indicator
10	Response time
11	Calibration Due indicator
12	Number of calibration points and method of calibration

**Note:** Lower display shows '2Cell' or '4Cell' when a 2-cell or 4-Cell conductivity probe is connected.

- END OF SALINITY SECTION -

# RESISTIVITY

## PARAMETER GUIDE

1. Resistivity Setup Mode
2. Resistivity Calibration Mode
3. Resistivity Measurement Mode

### FOR MODELS :

**COND 610**

**PC 650**

**CD 650    PCD 650**

# 1. Resistivity Setup

The resistivity setup screen presents many options to control the operating parameters, which can be controlled and set from the resistivity setup screen. The settings are displayed in 2 pages. Press **NEXT-P (F2)** and **PREV-P (F1)** to navigate through these pages.

## Resistivity Settings Page 1 – Operating Parameters

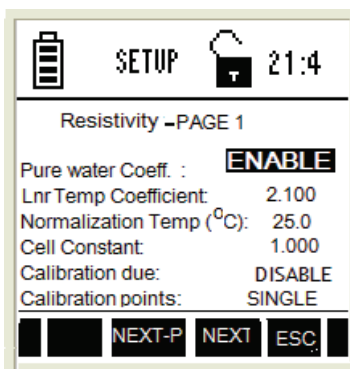

Figure 44: Resistivity Settings Page 1 – Operating Parameters

This page allows you to set operating parameters for resistivity measurement mode:

Parameter	Description	Factory Default
Pure water Coeff.	Pure water coefficient will be calculated and applied automatically for ultra pure water measurement if enabled.	ENABLE
Lnr Temp Coefficient	Specify temperature coefficient to measure temperature corrected conductivity	2.100
Normalization Temp	Select a default temperature that the meter will use along with the temperature coefficient to calculate a temperature corrected conductivity measurement.	25
Cell Constant	Select the appropriate cell constant of the conductivity cell. Available cell constants: 0.1 to 10	1.000
Calibration due	Specify number of days for the Conductivity calibration alarm. The meter shows CAL DUE indicator after calibration date. Available range : 0 to 30 (if enabled)	DISABLE
Calibration points	<b>Single</b> - In single point calibration one calibrated conductivity value can be used for the entire 5 conductivity ranges. <b>Multi</b> - In multi point calibration, you can calibrate one point in each of the measuring ranges (up to 5 points.)	Single
TDS factor	The TDS conversion factor is the number used by the meter to convert from conductivity to TDS. The TDS conversion factor automatically adjusts the reading. The TDS conversion factor can be set from 0.40 to 1.00	0.500

## Resistivity Settings Page 2 – Hi-Lo Set Points

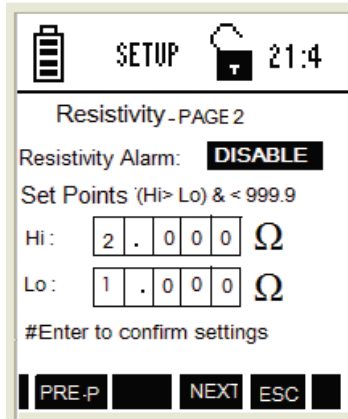

Figure 45: Resistivity Settings Page 2 – Hi-Lo Set Points

This page allows you to select alarm limits for resistivity measurement mode:

Parameter	Description	Factory Default
Alarm Set Points	Set alarm limits for the resistivity measurement mode: ENABLE – The measurement screen shows HI or LO alarm indicators when the meter reading is above 'HI alarm value' or below 'LO alarm value' specified in HI & LO $\Omega$ parameters (below) DISABLE – HI and LO alarms are not shown in the LCD	DISABLE
Hi $\Omega$	Specify Hi alarm value here. The Hi alarm occurs when the resistivity reading goes above this value  (This parameter is not editable when 'ALARM SET POINT' is disabled)	2.00 $\Omega$
Lo $\Omega$	Specify Lo alarm value here. The Lo alarm occurs when the resistivity reading goes below this value (This parameter is not editable when 'ALARM SET POINT' is disabled)	1.00 $\Omega$

☞ Press ▲ (Up) or ▼ (Down) arrow key to set high or low alarm point.

## 2. Resistivity Calibration Mode

Use a standard solution of known value for calibration. Use the single-point standardization option to measure samples that are close in value and multi-point standardization to measure wide range of samples.

1. Switch the meter on. Make sure the meter is in resistivity measurement mode.
2. Press **CAL (F2)** to go to calibration mode.
3. The meter shows the 'Calibration-Rinse Electrode' screen for a few seconds and then shows the cell constant adjustment screen.

**Note:** If the meter is password protected, you will be prompted to enter a password.

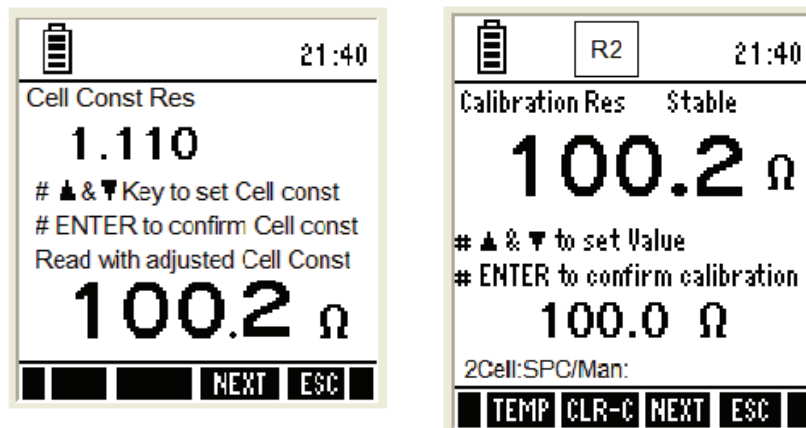

Figure 46 : Resistivity Cell Constant & Resistivity Calibration

4. The upper display of the resistivity cell constant screen shows the cell constant of your cell & lower display shows the measured value of the solution with adjusted cell constant. Press **▲** & **▼** keys to adjust the cell constant for your custom solution in upper display.
5. Press **ENTER** key to confirm the entered value and to go to resistivity calibration screen.
6. The screen shows two readings. The upper display shows the resistivity reading of the solution with respect to previous calibration (if any) & lower display shows the resistivity reading of the solution without any calibration. Use **▲** & **▼** keys to adjust the upper display of the resistivity value of your custom solution.
7. Press **ENTER** key to confirm the entered value.

**Note:** The function of the keys available on the resistivity cell constant/ calibration/ report screen is the same as previously described in conductivity calibration.

8. Rinse the probe with de-ionized water. Place it in the next solution and follow the steps 2 to 7 to calibrate other points, if **'MULTI'** point calibration is selected.
9. Press **ESC (F4)** to go to measurement mode. The meter shows the resistivity reading of the solution in measurement mode.

## 2.1 Resistivity Calibration Report

Calibration report gives you information on calibration. It includes date & time of calibration and the cal factor.

### 2.1.1 To View Calibration Report:

1. From resistivity measurement mode, press left **◀** or right **▶** arrow key to navigate to other available functions until you see **REPO** function in the LCD
2. Press **REPO (F2)** key. The calibration report is shown in the display
3. Press **PRIN (F2)** to transfer the calibration report to the computer.( Refer page **Error! Bookmark not defined.** to print data)

The screenshot shows a resistivity report for IrDA. The title is 'Report Res'. Below the title, it displays the date and time as '04 - Jan - 06 / 16:40' and the cell constant as 'Cell Const: 0.500'. A table follows with three columns: 'Cal. point', 'Range', and 'Cal. fact'. The table lists five calibration points, all with a calibration factor of 1.2550. The second point is specifically labeled '1.000 kΩ'. At the bottom of the screen, there are three buttons labeled 'PRIN', 'NEXT', and 'ESC'.

Cal. point	Range	Cal. fact
---	5	1.2550
---	4	1.2550
1.000 kΩ	3	1.2550
---	2	1.2550
---	1	1.2550

Figure 47 : Resistivity Report Screen

## 3. Resistivity Measurement Mode

In Resistivity measurement mode, the meter displays resistivity and temperature reading.

### 3.1 Indicators in Resistivity measurement mode

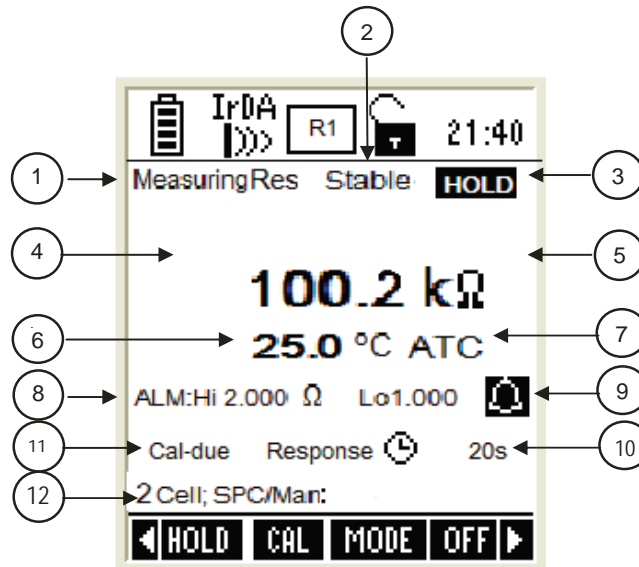

Figure 48 : Resistivity Measurement Screen

Item	Description
1	Measurement mode indicator
2	Appears when the reading is stable
3	Appears when the reading is on hold
4	Resistivity reading
5	Units of measurement
6	Temperature reading & units
7	Temperature compensation mode
8	Resistivity HI & LO Alarm limits
9	Resistivity Alarm indicator
10	Response time
11	Calibration Due indicator
12	Number of calibration points and method of calibration

- END OF RESISTIVITY SECTION -

# DISSOLVED OXYGEN

## PARAMETER GUIDE

### **PART A - % Saturation Mode**

1. O<sub>2</sub> % - DO Saturation Setup Mode
2. DO Calibration in % Saturation Mode (with ATC)
3. Percentage Saturation Measurement Mode

### **PART B – Concentration Mode (mg/L) (ppm)**

1. O<sub>2</sub> % - DO Saturation Setup Mode
2. DO Calibration in (mg/L) or (ppm) Concentration Mode
3. Concentration (mg/L) (ppm) Measurement Mode

### **FOR MODELS :**

**DO 600**

**CD 650**

**PD 650**

**PCD 650**

# PART A - % Saturation Mode

## 1. O2 % - DO Saturation Setup

The DO saturation (%) setup screen presents many options to control the operating parameters, which can be controlled and set from the DO setup screen. The settings are displayed in 2 pages. Press **NEXT-P (F2)** and **PREV-P (F1)** to navigate through these pages.

### DO (%) Settings Page 1 – Operating Parameters



Figure 49 : DO (%) – Page 1

Parameter	Function	Factory Default
Offset Cal	Allows to adjust % saturation offset calibration	0.0 %
Calibration due	Specify number of days for the DO calibration alarm. The meter shows CAL DUE indicator after calibration date. Available range : 0 to 30	5 days
Select Pressure Unit	Sets the unit for barometric pressure Available units: mmHg and kPa	mmHg
Measured Pressure	Barometric pressure as measured by the instrument.	
Adjusted Pressure	User adjusted value.	-
Pressure Compensation	ENABLE – The meter will compensate for the barometric pressure at the location depending on the altitude. DISABLE – No compensation for the pressure. (This is applicable only for the % saturation mode. For mg/L or ppm mode pressure comp. would always be applicable)	ENABLE

**NOTE:** During measurement, the meter will automatically measure and compensate for barometric pressure. However, if the user feels that barometric pressure is inaccurate and needs to be calibrated, it can be adjusted in the DO setup screen.

### DO (%) Settings Page 2 – Hi-Lo Set Points



Figure 50: DO (%) Settings Page 2 – Hi-Lo Set Points



This page allows you to set alarm limits for the DO saturation measurement mode. A visual alarm symbol will appear on the screen, if the DO value of the measurement is outside of the boundaries set by the minimum and maximum limits.

Parameter	Function	Factory Default
DO Alarm	Set alarm limits for the DO measurement modes: ENABLE – The measurement screen shows HI or LO alarm indicators when the meter reading is above 'HI alarm value' or below 'LO alarm value' specified in HI & LO % parameters (below) DISABLE – HI and LO alarms are not shown in the LCD	DISABLE
Hi DO %	Specify Hi alarm value here. The Hi alarm occurs when the DO reading goes above this value  (This parameter is not editable when 'ALARM SET POINT' is disabled)	200.0 %
Lo DO%	Specify Lo alarm value here. The Lo alarm occurs when the DO reading goes below this value  (This parameter is not editable when 'ALARM SET POINT' is	10.0 %

## 2. DO Calibration in % Saturation Mode (with ATC)

### 2.1 About DO(%) and DO (mg/L) Calibration

The calibration of % Saturation of DO will linearly affect the measurement for DO in mg/L. The amount of oxygen dissolved in water will depend on its temperature, atmospheric pressure and its salinity. It is therefore very important that the temperature is calibrated if necessary prior to the DO calibration.

Hence calibration in % Saturation of DO should be carried out first. This is described in the following section.

The 600 series meters can be calibrated quickly and easily in air. In % Saturation, the meter is able to perform either a one point calibration or a 2 point calibration. For one point calibration, it is recommended that you perform a 100% Saturation calibration in saturated air. If you opt for 2 point calibration, you can calibrate for 100% Saturation in saturated air and 0% Saturation using a zero oxygen solution.

The meters are capable of measuring barometric pressure with its built-in pressure sensor. In the event, the pressure reading is inaccurate, you can calibrate the value from the setup menu.

### 2.2 To calibrate 100% saturation

1. Switch the meter on and make sure the meter is in % saturation mode.
2. Hold the probe in the air gently with the sensor facing down and press **CAL (F2)** to start calibration.

**Note:** If the meter is password protected, you will be prompted to enter a password.

3. The meter shows the 'Dissolved O<sub>2</sub> Calibration-Rinse Electrode' screen for a few seconds to prompt user to rinse electrode with de-ionized water before calibration.

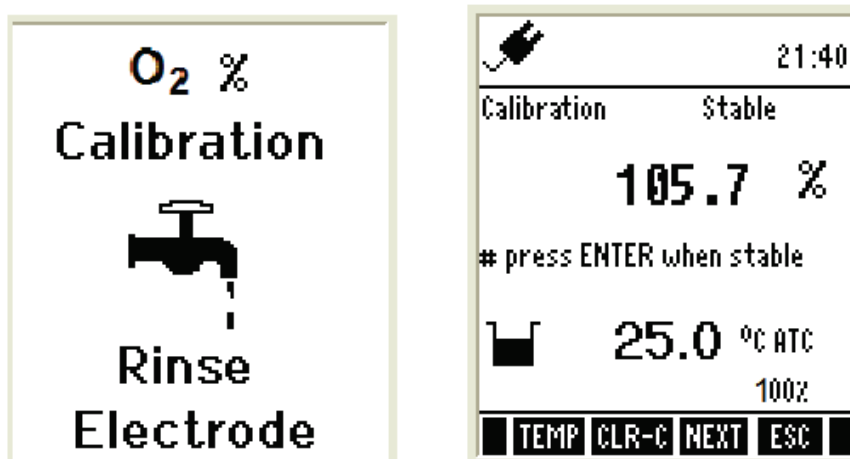

Figure 51: Saturation Calibration Screens

4. Rinse the probe well with de-ionized water. For best results, blot the end of the probe to dry it. Do not touch the membrane.
5. The meter then shows saturation calibration screen. The primary display will show the current value of measurement. Wait for the reading to stabilize.
6. Press **ENTER** key to confirm the calibration. The meter automatically calibrates to 100% air saturation and returns to the measurement mode.

**Note:** If you wish to completely re-calibrate the meter, you need to clear the previous calibration data. Press **CLR-C (F2)** key to clear previous calibration. The meter shows you the confirmation screen. Press **ENTER** key to confirm the deleting of previous calibration.

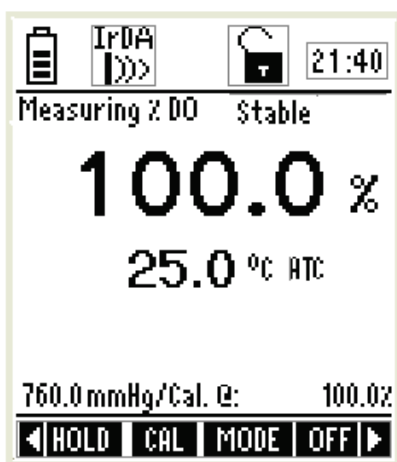

Figure 52 : Saturation Measurement Screen

Function Keys available in saturation calibration mode:	
<b>TEMP (F1)</b>	Goes to temperature calibration
<b>CLR-C (F2)</b>	Clears previous calibration (if any) after <b>ENTER</b> key is pressed in confirmation screen
<b>NEXT (F3)</b>	Shows calibration report
<b>ESC (F4)</b>	Exits from calibration and goes back to saturation measurement mode
<b>ENTER</b>	Confirms the calibration
<b>▲ ▼ ◀ ▶</b>	(Not functional)

### 2.3 To calibrate 0% saturation

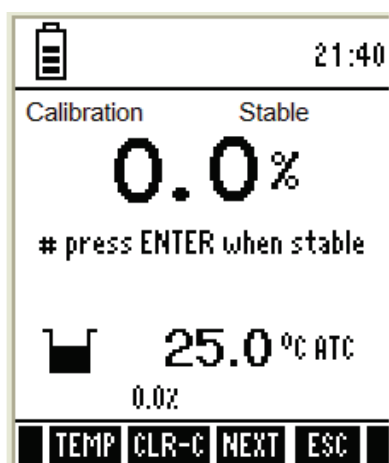

Figure 53 : 0% Saturation Calibration Screen

1. Press **MODE** key to select % Saturation mode.
2. Immerse the DO probe in 0% solution. Stir gently to create a homogenous solution.
3. Press **CAL** key to calibrate the meter. The meter shows the 'Dissolved O<sub>2</sub> Calibration-Rinse Electrode' screen for a few seconds to prompt user to rinse electrode with de-ionized water before calibration.
4. The meter then shows saturation calibration screen. Wait for the reading to stabilize.
5. The primary display will show the current value of measurement.
6. Press **ENTER** key to confirm the calibration. The meter automatically calibrates to 0% saturation and returns to the measurement mode.

**Note:** If you wish to completely re-calibrate the meter, you need to clear previous calibration data using the **CLR-C (F2)** key. The meter shows the confirmation screen. Press **ENTER** key to confirm deleting of the previous calibration. It will **clear all the calibration data including mg/L data.**

The keys that appear in 0% saturation calibration mode function similarly to the one as described in 100% saturation mode.

### 2.3.1 % DO Calibration Report

Calibration report gives you detailed information for the % saturation. It includes date & time, 0% and 100% saturation mV value, % saturation offset calibration and barometric pressure at which the solution was measured.

### 2.3.2 To View Calibration Report:

1. From % saturation measurement mode, press left ◀ or right ▶ arrow key to navigate to other available functions until you see **REPO** function in the LCD.
2. Press **REPO (F2)** key. The calibration report is shown in the display.
3. Press **PRIN (F2)** to transfer the calibration report to computer through IrDA.

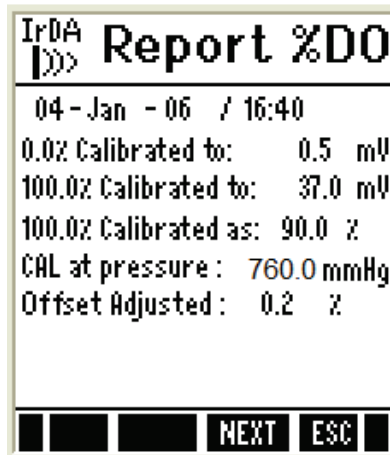

Figure 54: DO Calibration Report in % Saturation Mode

Function Keys available in saturation report screen:	
<b>PRIN (F2)</b>	Transfers calibration report to Computer through IrDA
<b>NEXT (F3)</b>	Goes to saturation measurement mode
<b>ESC (F4)</b>	Goes to saturation measurement mode
<b>ENTER</b>	(Not functional)
<b>▲ ▼ ◀ ▶</b>	(Not functional)

## 2.4 % Saturation Offset Adjustment

This option lets you offset the meter's value when cross referenced with another DO meter. For the PCD 650, DO600 and PD650 meters, you can adjust % saturation offset calibration within +/- 10.0% offset.

**Note:** When a user calibration is done, the offset will be reset to zero.

## 2.5 Set barometer pressure range and barometric pressure units

The PCD 650 meter is capable of measuring barometric pressure with its built-in pressure sensor. In the event that the pressure reading is inaccurate, you can calibrate the value from the setup menu.

## 2.6 Pressure compensation

If pressure comp. is set to '**ENABLE**', the meter will compensate for the barometric pressure at the location depending on the altitude. For example, if the barometric pressure is 700 mmHg the full scale calibration would be done at 92.1%. This is relative to the pressure at sea level.

If the pressure comp. is set to '**DISABLE**', then there would be no compensation for the pressure. The calibration would be done at 100% irrespective of the altitude.

**Note:** This is applicable only for the % Saturation mode. For mg/L or ppm mode, pressure compensation would always be applicable.

# 3. Percentage Saturation (%) Measurement Mode

In percentage saturation measurement mode, the meter displays % saturation and temperature reading. The LCD shows related information for the saturation measurement such as temperature compensation mode, stable indicator, barometric pressure, calibration points, probe condition, response time of the DO probe and alarm conditions. You can customize or enable/disable some of these indicators in the Setup mode.

## 3.1 Indicators in percentage saturation measurement mode

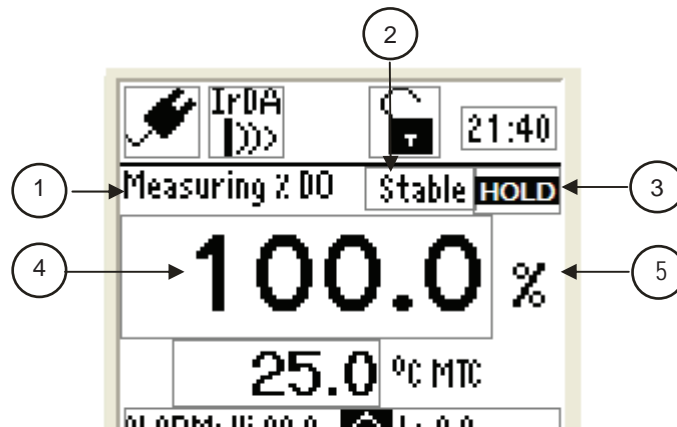



Figure 55 : Percentage Saturation Measurement Screen

Item	Description
1	Measurement mode indicator
2	Appears when the reading is stable
3	Appears when the reading is on hold
4	Saturation reading
5	Units of measurement
6	Temperature reading & units
7	Temperature compensation mode
8	Saturation HI & LO Alarm limits
9	Alarm indicator
10	Barometric pressure
11	Calibration points

## PART B – Concentration (mg/L) (ppm) Mode

### 1. O<sub>2</sub> mg/L (ppm) – DO Concentration Setup

DO Concentration (mg/L) setup screen present many options to control the operating parameters, which can be controlled and set from the DO setup screen. The settings are displayed in 2 pages. Press **NEXT-P (F2)** and **PREV-P (F1)** to navigate through these pages.

**DO (mg/L) – Page 1**

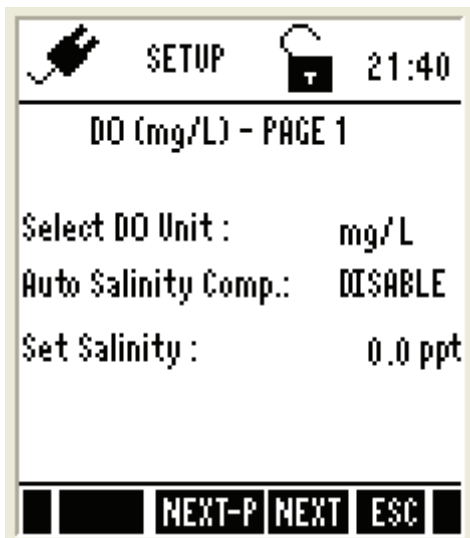

Figure 56 : DO (mg/L) – Page 1

This page allows you to set operating parameters for the DO Concentration measurement mode:

Parameter	Function	Factory Default
Select DO Unit	Sets the unit of measurement for DO	mg/L
	Available units: mg/L and ppm	
Auto Salinity Comp	<b>DISABLE</b> – No automatic compensate <b>ENABLE</b> – The meter will apply measured salinity for DO concentration of your sample.	DISABLE
	<b>Note:</b> This option is activated only in CD650 & PCD650.	
Set Salinity	Allows you to set the salinity (in ppt) for your solution	0.0 ppt
	Available range: 0 to 50 ppt	

**NOTE:** Auto salinity compensation will be applicable only in multi measurement mode and only if one of the measurement selected is conductivity related. Otherwise, a manually set salinity value will be applied.

### DO (mg/L) – Page 2

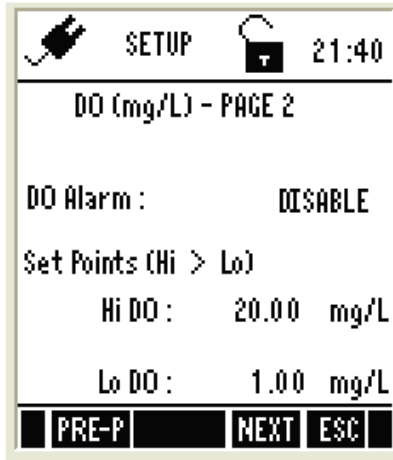

Figure 57: DO (mg/L) – Page 2



This page allows you to set alarm limits for the DO concentration mode. A visual alarm symbol will appear on the screen, if the DO value of the measurement is outside of the boundaries set by the minimum and maximum limits.

Parameter	Function	Factory Default
DO Alarm	Set alarm limits for the DO measurement modes: <b>ENABLE</b> – The measurement screen shows HI or LO alarm indicators when the meter reading is above 'HI alarm value' or below 'LO alarm value' specified in HI & LO % parameters (below) <b>DISABLE</b> – HI and LO alarms are not shown in the LCD	DISABLE
Hi DO mg/L	Specify Hi alarm value here. The Hi alarm occurs when the DO reading goes above this value  (This parameter is not editable when 'ALARM SET POINT' is disabled)	20.0 mg/L
Lo DO mg/L	Specify Lo alarm value here. The Lo alarm occurs when the DO reading goes below this value  (This parameter is not editable when 'ALARM SET POINT' is disabled)	1.0 mg/L

## 2. DO Calibration in mg/L mode or ppm Concentration mode

The amount of oxygen dissolved in a liquid will depend on its temperature, atmospheric pressure and salinity. It is therefore very important to set temperature and salinity correctly before attempting to do a calibration. The meter is capable of measuring barometric pressure with its built-in pressure sensor. In the event, the pressure reading is inaccurate, you can calibrate the value from the Setup menu.

1. Switch the meter on. Make sure the meter is in concentration measurement mode.
2. Rinse the probe well with de-ionized rinse water. For best accuracy, blot the end of the probe to dry it. Do not touch the membrane. Dip the probe into a solution with a known DO value.
3. Press **CAL (F2)** to go to calibration mode.

**Note:** If the meter is password protected, you will be prompted to enter a password.

4. The meter shows 'Dissolved O<sub>2</sub> Calibration-Rinse Electrode' screen for a few seconds to prompt user to rinse electrode with de-ionized water before calibration.

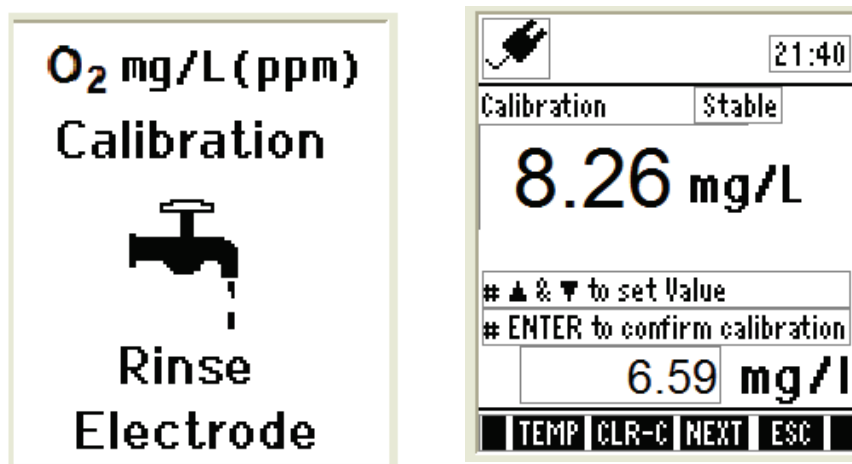

Figure 58 : Concentration Calibration Screens

5. The meter then shows the concentration calibration screen.
6. The upper display of the calibration screen will show the current value of the measurement and the secondary display will show the value to

which the meter is going to be calibrated. Press ▲ & ▼ keys to adjust the reading to the known oxygen concentration of the sample.

7. Press **ENTER** key to confirm the entered value.
8. Press **ESC (F4)** to go to measurement mode. The meter shows the concentration reading of the solution in measurement mode.

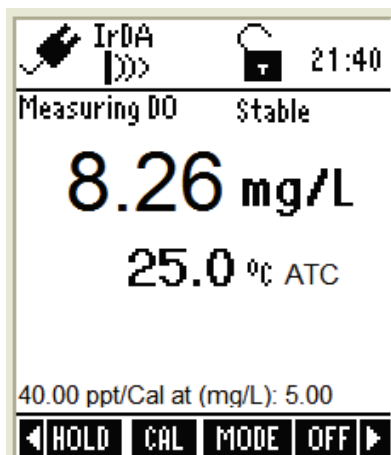

Figure 59 : Concentration Calibration

**Note:** The function of the keys available on the concentration calibration/report screen is same as previously described in saturation calibration.

## 2.1 Concentration Calibration Report

Calibration report gives you information on calibrated temperature and calibration at pressure and salinity. It includes date & time on which the last calibration was done and the offset.

### 2.1.1 To View Calibration Report:

1. From concentration measurement mode, press left ◀ or right ▶ arrow key to navigate to other available functions until you see **REPO** function in the LCD.
2. Press **REPO (F2)** key. The calibration report is shown in the display. Press **PRIN (F2)** to transfer the calibration report to the computer.

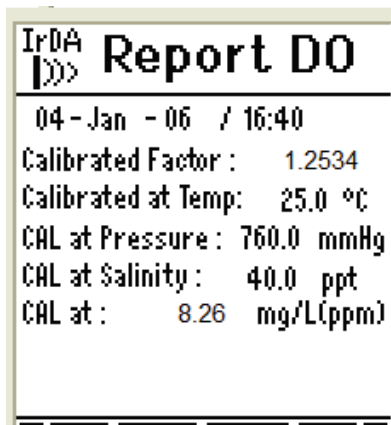

Figure 60 : DO Calibration Report in Concentration Mode

## 2.2 Set Salinity

This option allows you to set the salinity (in ppt) for your solution, as the dissolved salts alter the relationship between the partial pressure of oxygen and the oxygen concentration in water. By setting the salinity, the meter will compensate for the impact of salinity on the partial pressure/oxygen concentration relationship of your sample. The salinity can be set from 0 to 50 ppt.

### 2.2.1 Auto Salinity Compensation

If auto salinity comp. is enabled, the meter will automatically compensate for salinity for determining dissolved oxygen concentration of the sample. Auto salinity compensation will be applicable only in multi measurement mode and only if one of the measurement selected is conductivity related. **This option is activated only in CD650 & PCD650.** Otherwise, a manually set salinity value will be applied.

## 3. Concentration in Measurement Mode

In concentration measurement mode, the meter displays concentration and temperature readings. The LCD shows related information for the concentration measurement such as temperature compensation mode, stable indicator, salinity value, probe condition, response time of the DO probe and alarm conditions. You can customize or enable/disable some of these indicators in the Setup mode.

### 3.1 Indicators in concentration measurement screen

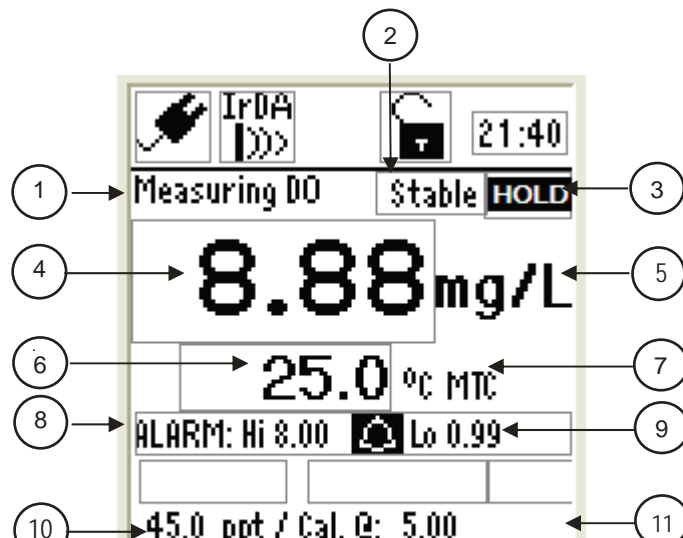

**Figure 61 :Concentration Measurement Screen**

<b>Item</b>	<b>Description</b>
1	Measurement mode indicator
2	Appears when the reading is stable
3	Appears when the reading is on hold
4	Concentration reading
5	Units of measurement
6	Temperature reading & units
7	Temperature compensation mode
8	HI & LO Alarm limits
9	Alarm indicator
10	ppt indicator for input of salinity value
11	DO calibration point

## **3.2 Dissolved Oxygen Probe**

### **3.2.1 Dissolved Oxygen Principle**

The probe is a galvanic measuring element which produces an output proportional to the oxygen present in the medium in which it is placed. The galvanic probe design lets you take measurements immediately – without the typical 15 minute wait of other dissolved oxygen probes.

The probe consists of two parts:

- An upper part consisting of an anode, a cathode, and cable.
- A lower part consisting of a membrane cap, membrane, and electrolyte solution.

Oxygen diffuses through the membrane onto the cathode, where it is consumed. This process produces an electrical current which flows through the cable to the meter. The electric current produced is proportional to the oxygen that passes through the membrane and the layer of electrolyte. This makes it possible to measure the partial pressure of oxygen in the sample at a given temperature.

Since the DO in the sample is consumed by the cathode it is essential that a new sample must flow past the membrane of the probe to prevent the occurrence of false readings. The probe uses very little oxygen for its measurement. This enables it to function correctly with liquid movement as low as 2.5 cm/sec.

The permeability of the membrane to oxygen varies greatly with temperature. Therefore compensation is needed for this variation. The DO probe comes with an in-built Temperature Compensation for the membrane variation.

### 3.2.2 Probe Care

Under typical operating conditions, the probe should last for several years. Proper care and maintenance will help you receive the maximum probe life and ensure more accurate readings.

Since any deposits on the membrane surface act as a barrier to oxygen diffusing through the membrane, the membrane must be cleaned at regular intervals to assure maximum reliability.

After using the probe, rinse the probe in clean water and wipe it with a soft cloth or paper to avoid any hardening of deposits. If growth develops on the probe, use a disinfecting chemical to clean.

**NOTE:** Although the membrane is strong and not easily damaged, wipe it gently while cleaning it. If the membrane is damaged or torn, the probe will no longer function.

There are no special probe storage requirements.

### 3.2.3 Membrane Housing Replacement

Replacement of the membrane cap housing/ membrane is required only when you cannot calibrate the probe, or if the membrane is damaged.

Typical membrane damages are punctures or wrinkles caused during measurements or cleaning.

Your new DO probe comes with replacement membrane housing. To order more replacement membrane housing, see the “Accessories” section page.

#### To replace the membrane cap (with pre-installed membrane)

1. Replacement is much easier with single membrane housing. Unscrew the old membrane cap housing.

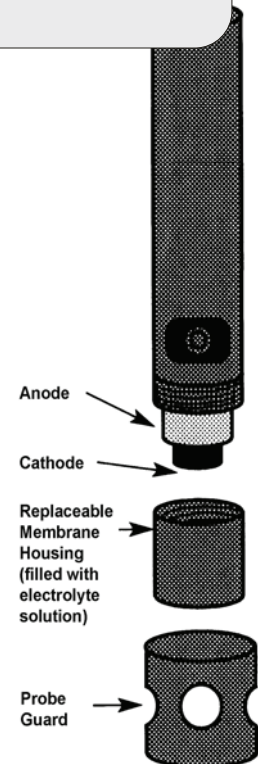

Figure 62: Positioning

2. Hold the probe under hot running water and brush away the white oxide on the cylindrical anode with a stiff plastic brush – do not use metal cleaning material.
3. If the cathode has any deposits, remove them with a light scouring powder. Do not polish the cathode.
4. Fill the new membrane cap housing with electrolyte solution and inspect the bottom for leaks. If the solution drops are leaking from the membrane, use new cap housing.
5. If the assembly is leak-free, fill the membrane cap housing with electrolyte to the brim.
6. Tap the side of the housing gently to remove any air bubble that may be sticking to the membrane.
7. Screw the cap onto the probe. Excess electrolyte will drain out.
8. Replace probe guard.
9. Calibrate the probe after the % saturation readings have stabilised.

### 3.2.4 Membrane/O-ring Replacement (Optional Procedure)

It is recommended only experienced service personnel can perform this procedure.

This procedure is OPTIONAL, and should only be performed if you have new membrane and O-ring. You are also required to have a membrane installation tool. These items are available as optional accessories in the “Accessories” section.

1. Pull off the probe guard.
2. Unscrew the membrane cap from the probe.
3. Hold the probe under hot running water and brush away the white oxide on the cylindrical anode with a stiff plastic brush – do not use metal cleaning material.
4. If the cathode has any deposits, remove them with a light scouring powder. Do not polish the cathode.
5. Using the installation tool, unscrew and remove the membrane lock from the membrane cap. See Figure 64 on the following page.
6. Remove the membrane and O-ring. Discard both.
7. Rinse the membrane cap and membrane lock in tap water.
8. Install a new O-ring inside the membrane cap.
9. Install a new membrane. Make sure the membrane covers the O-ring all around its circumference.

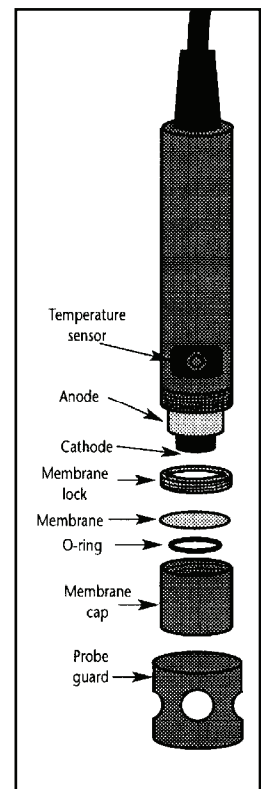
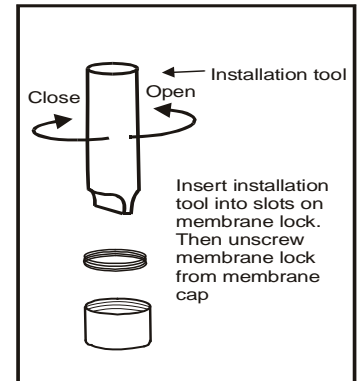

Figure 64: Disassembly

10. Using the installation tool, screw the membrane lock back into the cap. Tighten the lock firmly over the membrane and O-ring, but do not over tighten.
11. Inspect the membrane for wrinkles. If wrinkles exist, remove the membrane and repeat steps 8 – 11.
12. Fill the membrane cap with water and inspect the bottom for leaks. If water drops are leaking from the membrane, re-seal the membrane on the O-ring (repeat steps 8 – 11, for membrane replacement only).
13. If the assembly is leak-free, empty the water and fill the membrane cap with electrolyte to the brim.
14. Tap the side of the housing gently to remove any air bubble that may be sticking to the membrane.
15. Screw the cap onto the probe. Excess electrolyte will drain out.
16. Replace probe guard.
17. Calibrate the probe after the % saturation readings have stabilised.



**Figure 64:** Use tool to take out (or put in) membrane

**Note:** Membranes can only be used once. When a membrane cap is screwed onto the probe, the membrane is stretched by the cathode. If the same O-ring and the membrane is used a second time it will not fit perfectly onto the cathode. This will result in erratic readings.

### 3.2.5 Electrolyte Solution

The electrolyte solution in your probe's cap will deplete on usage and will need to be replaced periodically.

Your new DO probe comes with accessories of one replacement electrolyte solution and a spare membrane cap. The replacement electrolyte comes premixed and ready to use. To order more electrolyte solution, see "Accessories" section.

-END OF D.O. SECTION-

## NOTES