

VDL48

DC Voltage Datalogger (0 to 48V)

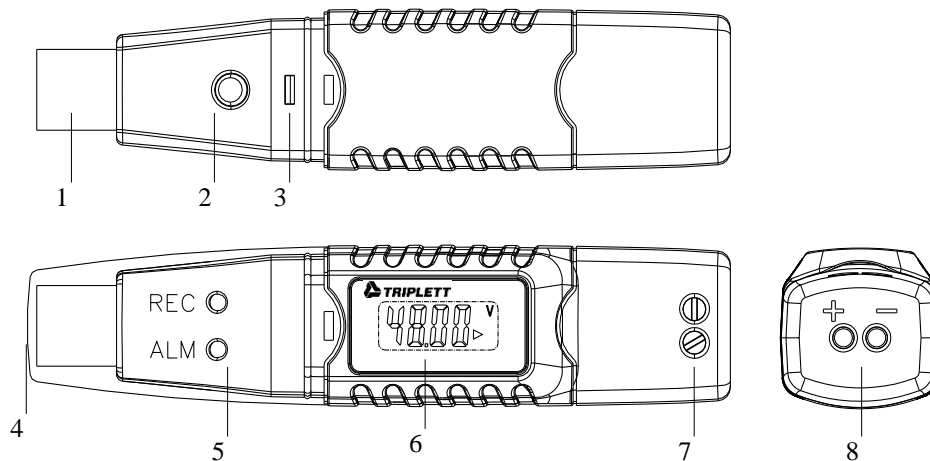

1. Product overview



- ① USB connection plug
- ② Key
- ③ Case buckle
- ④ Protective cap
- ⑤ Red and green LED control light
- ⑥ LCD
- ⑦ Measuring wire set screw
- ⑧ Measuring wire ports

2.LCD indicators

The current state of the recording is indicated by the following symbols:

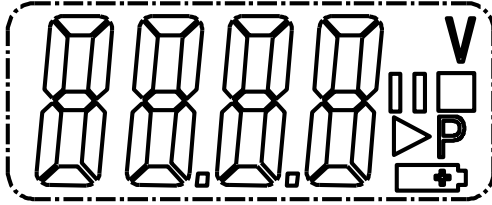

.ong Press key

V is voltage unit

After 8.6 hours

||| Waiting to press the button to start

Short press key, until display "STOP"

Long Press key

Stop recording

▶ Recording started

Short press key, until display "STOP"

Long Press key

After 108 days

□ Recording stopped

Short press key, until display "STOP"

Long Press key

Stop recording



P This indicated that the device is configured and recording is not started. It will disappear as

soon as the logger is recording data.

Short press key, until display "STOP"

Long Press key

After 8.6 hours

⊞ Low power indicator

Short press key, until display "STOP"

Long Press key

Stop recording

State 1:

Short press key, until display "STOP"

Long Press key

After 108 days

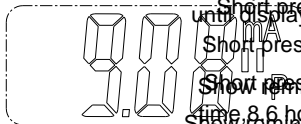
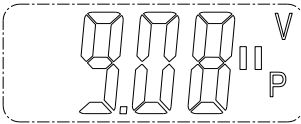

Short press key, until display "STOP"

After 8.6 hours

Stop recording

||| The logger is in the "Manual(Start upon time 8.6 hours) mode, but the start key has not been pressed yet.

State 2:

Long Press key

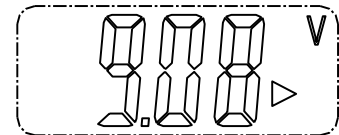

▶ The logger is recording.

Show remaining record time 8.6 hours

Show remaining record time 8.6 hours

Show remaining record time 108 days

Show remaining record time 108 days

Show remaining record time 108 days

Show remaining record time 8.6 hours

Show remaining record time 8.6 hours

Show remaining record time 108 days

Show remaining record time 8.6 hours

Show remaining record time 8.6 hours

Show remaining record time 8.6 hours

Show remaining record time 8.6 hours

After 8.6 hours

After 8.6 hours

After 8.6 hours

After 8.6 hours

After 8.6 hours

After 8.6 hours

After 8.6 hours

After 8.6 hours

After 8.6 hours

After 8.6 hours

After 8.6 hours

After 8.6 hours

After 8.6 hours

After 8.6 hours

After 8.6 hours

After 8.6 hours

After 8.6 hours

After 8.6 hours

After 8.6 hours

After 8.6 hours

After 8.6 hours

After 8.6 hours

After 8.6 hours

After 8.6 hours

After 8.6 hours

After 8.6 hours

After 8.6 hours

After 8.6 hours

After 8.6 hours

ong Press key

Firmware upgrade: connect to PC, copy the firmware file to the logger disk, waiting 2 minutes.

Long press key

□ Recording is stopped.

Firmware upgrade:

Long Press key

After 108 days

Long Press key

Long Press key

Long Press key

Long Press key

Stop recording
time, 8.6 hours.

Short press key
Short press key,
until display "STOP"

Show remaining record
time, 108 days.

OL sign:

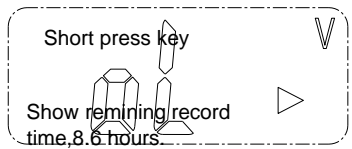

Short press key,
until display "STOP"

Show remaining record
time, 108 days

2. Start Recording

This page is available if the logger is in "Start at key press" mode.

After Setting
"Start upon
keypress" mode

Short press key,
until display "STOP"

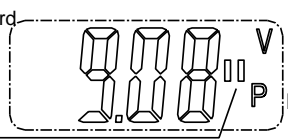

Short press key,
until display "STOP"

3. Stop Recording

Select this function to stop recording if the logger is programmed for manual stop. Press and hold the button for three seconds to terminate recording.

Short press key,
until display "STOP"

Short press key,
until display "STOP"

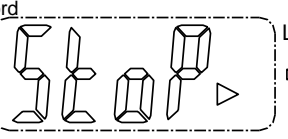

Short press key,
until display "STOP"

4. Remaining Recording Time

Shows the remaining time until end of recording.

After Setting
"Start upon
keypress" mode
Short press key,
until display "STOP"

Short press key,
until display "STOP"

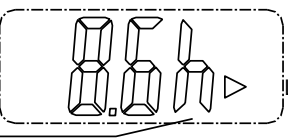

Short press key,
until display "STOP"

Short press key,
until display "STOP"

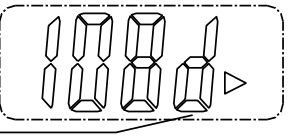

5. Show was upgrade

Show remaining record
time, 8.6 hours.

Show remaining record
time, 108 days.

Show remaining record
time, 8.6 hours.

Show remaining record
time, 108 days

Show remaining record
time, 8.6 hours.

Short press key,
until display "up"

Short press key,
until display "up"

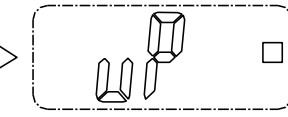

After 108 days
Long Press key
Stop recording

After 8.6 hours
Stop recording

Stop recording

Stop recording
Long Press key
After 108 days
Long Press key

Stop recording
Long Press key

Stop recording
Long Press key
After 108 days
Long Press key

Stop recording
Long Press key

After 8.6 hours
Long press key
Long Press key
Stop recording

Stop recording

After 8.6 hours
Stop recording
Long Press key
After 8.6 hours

After 108 days
Stop recording

Stop recording
After 108 days

Stop recording
Long Press key
Stop recording

After 108 days
Long Press key
Stop recording

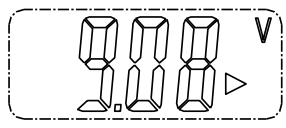

Firmware upgrade:
connect to PC, copy the
firmware file to the logger
disk, waiting 2 minutes.

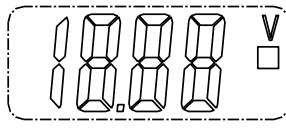

Firmware upgrade:
connect to PC, copy the
firmware file to the logger
disk, waiting 2 minutes.

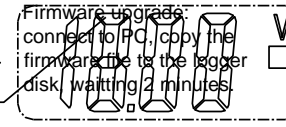

Firmware upgrade:
connect to PC, copy the
firmware file to the logger
disk, waiting 2 minutes.

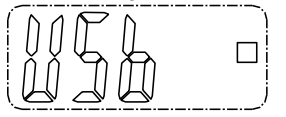

Then insert the device into the PC USB port. The device will appear as a Mass Storage Device in PC with no content. Drag and drop the firmware to the folder. The device will disappear in the OS. DO NOT unplug the device from PC. After upgrade completed, Device will automatically appear as a Mass Storage Device again. The firmware version is indicated in the left bottom corner of the ".pdf" test report generated.

6. Generating a PDF-File

As soon as the logger is connected to a USB-slot, a PDF file with all recorded data in chart and an overview of alarms is generated automatically. The red led indicator lights up during PDF generation.

Depending on the number of stored measurements, generating the PDF-file might take up to 60 seconds.

As soon as the logger is reprogrammed, the PDF file on the logger will be deleted.

7. LED Status Guide

LED Indication	Action
Cycle green single flash	-Logging
Cycle red single flash	-Logging, low alarm or high alarm. -Manual mode waiting start -Memory full -Stop upon stop time -Stop upon key
Green double flash one time	-Setup successful -check upgrade file successful

8. Specification

DC Voltage DataLogger	Range	48.00V (DC Voltage DataLogger)
	Resolution	0.01
	Accuracy	0.5%reading+3
Logging rate	1second—24h	
Display refresh rate	2seconds (after the key operation, within 5minutes). Default 30 seconds.	
Memory	31320	
Operating Environment	0 to 50 °C(32 to 104 °F) <80%RH	
Storage Environment	-10 to 60 °C(14 to 140°F) <70%RH	
Battery type	LS14250	
*Accuracy: test at 23±5°C.		

Sample Rate	Record Time	Sample Rate	Record Time
1second	8.7hour	20second	7.2day
2second	17.4hour	30second	10.8day
3second	26.1hour	1minutes	21.7day
4second	34.8hour	5minutes	108.7day
5second	43.5hour	15minutes	326.2day
10second	87.0hour	30minutes	652.5day

9.Replacing the Battery

Battery Type: 3.6V 14250 lithium battery

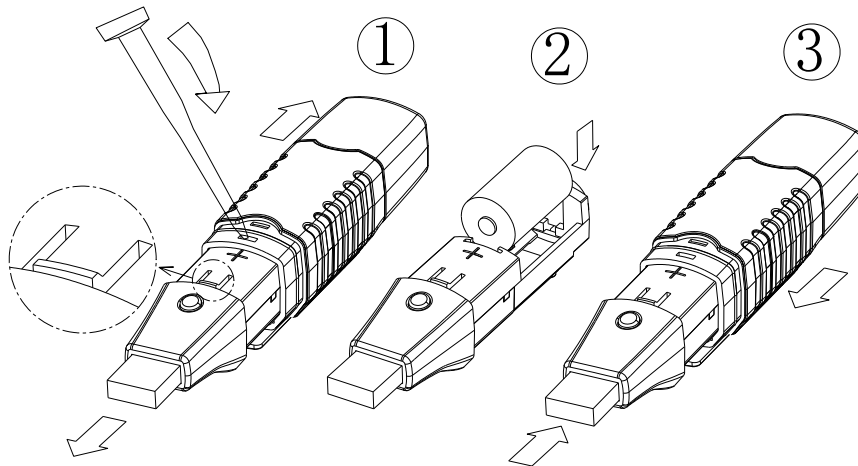

Warranty

Triplett / Jewell Instruments extends the following warranty to the original purchaser of these goods for use. Triplett warrants to the original purchaser for use that the products sold by it will be free from defects in workmanship and material for a period of (1) one year from the date of purchase. This warranty does not apply to any of our products which have been repaired or altered by unauthorized persons in any way or purchased from unauthorized distributors so as, in our sole judgment, to injure their stability or reliability, or which have been subject to misuse, abuse, misapplication, negligence, accident or which have had the serial numbers altered, defaced, or removed. Accessories, including batteries are not covered by this warranty.

Copyright © 2023 Triplett