

User Manual







# UVLT150

UV-AB Light Meter



# CONTENTS

1.	Introduction .....	1
2.	Accessories .....	1
3.	Safety Precaution.....	2
4.	Instrument Description .....	3
4.1.	LCD Display	
4.2.	Buttons:.....	3
5.	General Specifications: .....	4
6.	Electrical Specifications .....	4
7.	Operation .....	5
7.1.	Power button.....	5
7.2.	 Button .....	5
7.3.	 Button .....	5
7.4.	 button.....	5
7.5.	 Data hold button.....	5
8.	Maintenance or Repair.....	6
9.	Battery Replacement.....	7
10.	Product Disposal .....	7

## 1. Introduction

Please, read the operating instructions in detail before you use this UVAB optics meter, so you will operate the meter correctly. This meter can be used in industry and home.



### **Application:**

- Monitoring blue light radiation hazards in welding.
- UV sterilization.
- Graphic arts.
- Photochemical matching.
- UV EPROM erasure.
- Photos resist exposure.
- Curing of inks, adhesives, and coatings.
- Convenient, no need to adjust, data displayed clearly.
- Weathering "degradation studies".
- UV sterilization.
- Virology.
- Microbial genetics.
- DNA research.
- Biologic hoods.
- General laboratory use.

## 2. Accessories

- |   |                                    |
|---|------------------------------------|
| 1 | Meter                              |
| 1 | Carrying case                      |
| 1 | User's Manual                      |
| 2 | Battery 1.5V( AAA MN2400 LR03 AM4) |

### 3. Safety Precaution

	Caution! Please refer to this manual. Improper use may damage the meter and its components.
	Complies with European Directive.

- Do not operate in environments with flammable gas or humid environments.
- Operating altitude: up to 2000M.
- Operating environment: Indoor use; Pollution degree 2.
- Clean with soft cloth when dirty, such as glasses cloth. Do not clean with chemicals and other solvents.
- EMC: EN61326-1:CISPR 11:Group 1, Class B
  - ✧ Class B – Equipment for use in all establishments other than domestic.
  - ✧ Group 1 – RF energy generated is needed for internal functioning.

## 4. Instrument Description

### 4.1. LCD DISPLAY

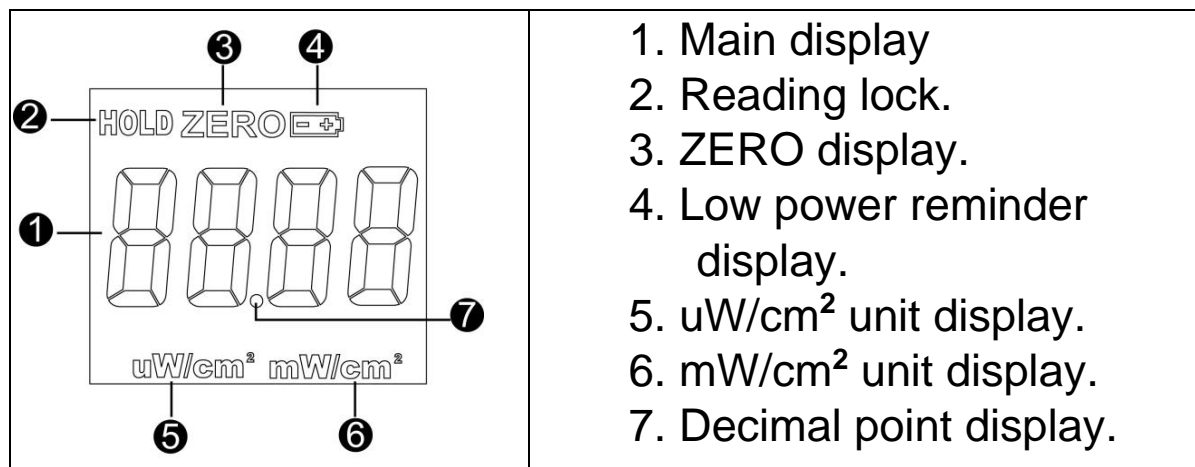

### 4.2. Buttons:

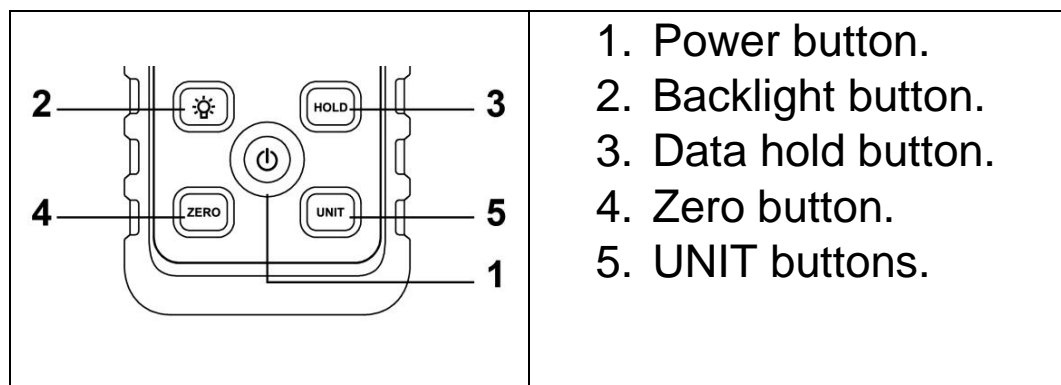

## 5. General Specifications:

- Zero function.
- 1 $\mu$ W/cm<sup>2</sup> or 1.00mW/cm<sup>2</sup> unit selection.
- Data hold.
- Back light: it will turn off automatically after turned on for 15 seconds .
- Low battery indication
- Overload display: "OL".
- Low battery indication "":
- Auto power off after 15 minutes.
- Operating : Temperature 5 °C ~40 °C , below 80%RH.
- Storage temp. & RH : -10 °C ~60 °C , below 70%RH.
- Sensor: UV light sensor.

## 6. Electrical Specifications

DISPLAY	3-3/4 digits LCD with maximum reading 3999
Measuring range	3999 $\mu$ W/cm <sup>2</sup> , 39.99mW/cm <sup>2</sup>
Resolution	1 $\mu$ w/cm <sup>2</sup> ,0.01mW/cm <sup>2</sup>
Accuracy	$\pm$ 4(%FS + 2dgt) FS: full scale 15%:sunlight ultraviolet.
Spectrum Range	290~390nm
Calibration Point	365nm
Sample Time	Approx. 3 sec.
Power Supply	2 batteries 1.5V
Battery life	approx. 50 hr.
Weight	approx. 90g..
Size	133(L) x 48(W) x 23 (H)mm

## 7. Operation

### 7.1. Power button

Press the “” button to turn ON or turn off.

### 7.2. Button

Press the “” button for the zero adjustment if any digits are appearing. When the lid of the light receiving part is not opened, if it is found that it is not zeroed

### 7.3. Button

Press “” key backlight light on.

Backlight light turns off automatically after 15 seconds.

### 7.4. button

Press the “” button to switch from  $\mu\text{W}/\text{cm}^2$  to  $\text{mW}/\text{cm}^2$ .

### 7.5. Data hold button

Press  to enable or disable the data hold function.

## 8. Maintenance or Repair

1. When the When “” symbol is displayed on the LCD, it means that there is insufficient power; please change the battery immediately to ensure its accuracy.
2. Do not place the meter in locations that have high temperature, humidity or that are exposed to direct sunlight.
3. Remember to turn off the power after usage; remove the battery if not used for a long period of time in order to prevent battery leakage and causing damages to internal components.
4. When the instrument failure, only by the authorized service provider or return the original repair.

## 9. Battery Replacement

1. Turn off the power.
2. Open the battery cover at the back of the meter, remove the batteries.
3. Please insert new 1.5V x 2 batteries according to the polarities.
4. Put the battery cover back in place.

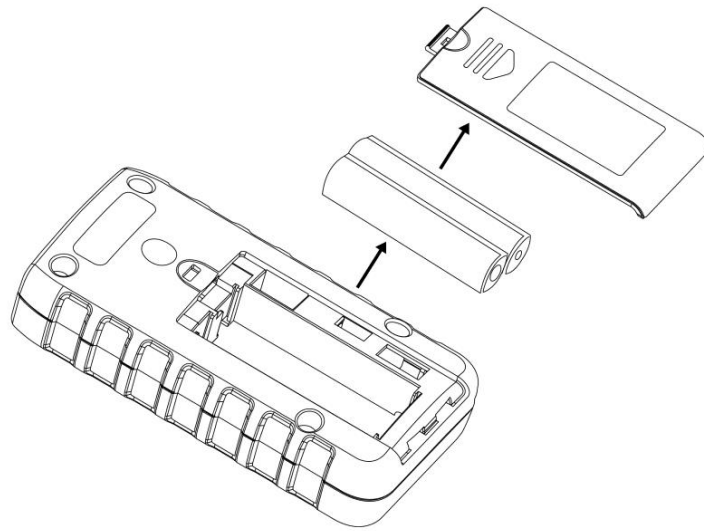

## 10. Product Disposal

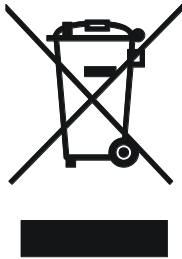

Note: This symbol indicates that the meter and its accessories must be separated and processed properly.

## **WARRANTY STATEMENT**

Triplett Test Equipment offers a one-year warranty to the original purchaser of its products. We guarantee that our products will be free from defects in workmanship and materials for one (1) year from the purchase date.

### **This warranty does not cover:**

- Products purchased from unauthorized distributors.
- Items that have been repaired or altered by unauthorized individuals.
- Damage from misuse, abuse, misapplication, negligence, or accidents.
- Products with altered, defaced, or removed serial numbers.
- Accessories, including batteries.

**Copyright © 2025**

