

# User Manual



## SFM500

### Static Field Meter



# Contents

1	Introduction .....	1
2	Accessories .....	1
3	Safety Precaution .....	1
4	Instrument Description .....	2
5	Operation .....	3
	5-1 Disable Auto Power Off Mode.....	4
	5-2 Zeroing.....	4
	5-3 Manual record mode.....	4
	5-4 Display logs mode .....	5
	5-5 Backlight Mode .....	5
	5-6 Setting mode.....	5
6	Specifications.....	7
7	Maintenance or Repair .....	8
8	Battery Replacement .....	8
9	Product Disposal.....	8



# 1 Introduction

This contactless precise electrostatic field meter can immediately sensor the static voltage on a charged body without contact. The measuring range is 0.010kV ~ 20.000kV with a sensing distance of 1 inch (2.54cm). The meter provides an alarm function for prompt.

## 2 Accessories

- 1 Meter
- 1 User's Manual
- 1 9V alkaline battery
- 1 Carrying case

## 3 Safety Precaution

	Caution! Please refer to this manual. Improper use may damage the meter and its components.
	Complies with European Directive.

- Do not operate in environments with flammable gas or humid environments.
- Operating altitude: up to 2000M.
- Operating environment: Indoor use; Pollution degree 2.
- Clean with soft cloth when dirty, such as glasses cloth. Do not clean with chemicals and other solvents.
- EMC: EN61326-1:CISPR 11:Group 1, Class B
  - ◇ Class B – Equipment for use in all establishments other than domestic.
  - ◇ Group 1 – RF energy generated is needed for internal functioning.

## 4 Instrument Description

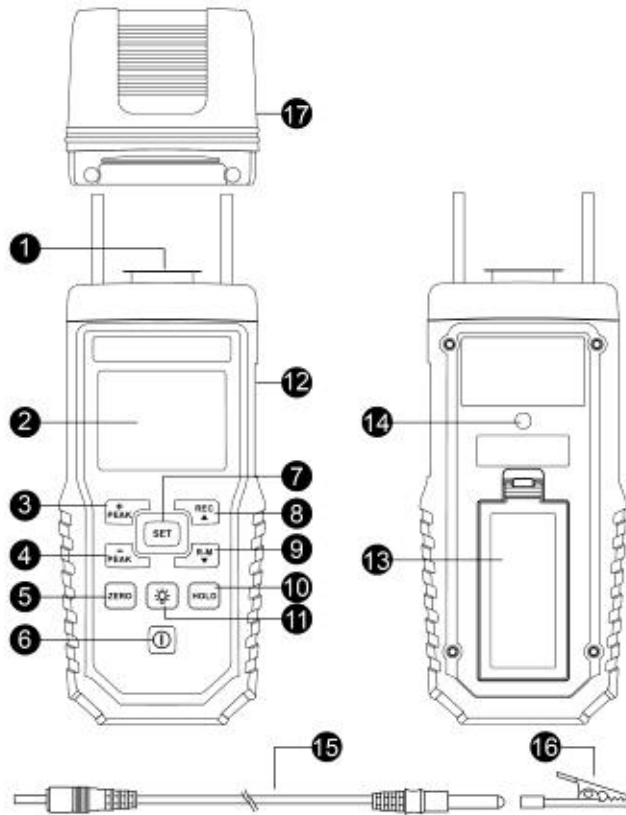

1. Sensor
2. LCD display
3. +peak value (max. value)
4. -peak value (min. value)
5. Zero setting button
6. Power button
7. Function Setting button
8. Record readings / up button
9. Display logs / down button
10. Data hold
11. Backlight button
12. Grounding socket
13. Tripod nut
14. battery cover
15. Grounding wire
16. Crocodile clip
17. Protection cap

## 5 Operation



	<b>Warning</b>
	<b>The meter must be securely grounded during measuring, and the holding position not close to the sensor so to avoid the risk of electric shock.</b>

- Before use, the meter must be grounded. Please choose one of the following two methods to ground the meter:





1. The first method is connecting the meter's ground socket with one end of the grounding wire of accessory and connecting to the earth end of the building with another end of the grounding wire, or connecting to the electrical socket for earthing, or clamping the earth end with a crocodile clip.
2. The second method is the operator wears the anti-static wrist strap and connects to the earth end of the building with another end of the anti-static wrist strap. Note that the anti-static wrist strap is not an accessory and should be prepared by yourself.

- During the measuring for static voltage, please fasten ceramic spacers on the fix-threads beside the sensor. Keep the sensor from the area under test for 1 inch (2.54 cm).



- Click the  Power button.
- Make sure the meter is grounded before operating.
- Aim the sensor point to the area under test, keeping your fingers away from the area under test as possible.
- Read the value (static voltage value) on the LCD.

- As completing a measurement, click the  button to lock the reading permanently to hold the reading on the LCD for a long time; click the  button again to unlock

to unlock the reading.

- Click the  button to continuously update the maximum measuring value on the LCD to keep the +peak value (max. value), click the  button again to cancel.
- Click the  button to continuously update the minimum measuring value on the LCD to keep the -peak value (min. value), click the  button again to cancel.

### 5-1 Disable Auto Power Off Mode

The meter will automatically power off after powering on for about 15 minutes. The LCD displays  symbol at the mode. If to disable the function, press and hold the  button for more than 2 seconds.





### 5-2 Zeroing

- Prior to measuring the static voltage, click the  button for more than 2 seconds to clear the reading if an old reading survived on the LCD. (Note: Set the static voltage of the surrounding environment to be 0, if not, the measuring may be biased.)

### 5-3 Manual record mode

- At measuring mode, click  button to record the present reading, the records can be logged up to 99.

## 5-4 Display logs mode

- At measuring mode, click  button to display the readings of logged data while MEM symbol appears on the LCD. Click  button again to quit the mode. Click  button or  button to select the number of logs.





## 5-5 Backlight Mode

- During measuring, click  button to turn on the backlight of LCD for 15 seconds and then turn off automatically.





## 5-6 Setting mode

Press  button repeatedly and enter the settings of Step 1 to 4 sequentially.





### Step 1. Set (HI) + alarm

1. While the LCD displays SET1 HI symbol, Press  or  to move digits, press  or  button to change the settings.
2. Quickly press  button again and enter Step 2.







### Step 2. Set (LO)- alarm

1. While the LCD displays SET2 LO symbol, Press  or  to move digits, press  or  button to change the settings.
2. Quickly press  button again and enter Step 3.

### Step 3. Set the alarm on or off

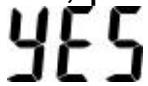
1. While the LCD displays SET3 and  symbols, press  or  button to change as  or OFF.
2. Quickly press  button again and enter Step 4.

### Step 4. Clear memory

1. While the LCD displays SET4 dEL symbol, press  or  button to change as  or . As  is chosen, press  button to get memory cleared.
2. Quickly press  button to quit the settings status.

**PS: If to quit the settings status, press  button in any step.**

## 6 Specifications

- Display for readings: Liquid crystal display (LCD) of 4 1/2 digits with the displaying value up to 19999.
- Resolution: 0.001KV.
- Measuring range : -19.999KV~+19.999KV
- Accuracy:  $\pm(5\%+10\text{dgt})$ .
- Overloading indication: OL.
- Sampling period: 2 times per second.
- Battery: 9V NEDA 1604 、 IEC 6F22 or JIS 006P.
- Battery life: Approximately 100 hours.
- Operation temperature and humidity: 5 to 40°C (41 to 104°F); < 80%RH.
- Storage temperature and humidity: -10°C to 60°C (14 to 140 °F), < 70%RH.
- Weight: Approximately 210g.
- Dimension: 148(L)x65(W)x37.5(H)mm.
- Professional and precise static voltmeter with resolution of 0.001kV.
- Function including Data lock (HOLD), Max. value (+PEAK) lock, Min. value (-PEAK) lock, Record (REC) the displayed value, Display the logged data (R-M), Zeroing (ZERO)
- High voltage alarm: +/- 18.000KV ◦
- Alarm setting:0.001KV~18.000KV
- Auto power off (for about 15 minutes).
- Battery low display .
- Overload display OL.

## 7 Maintenance or Repair

1. When the  symbol is displayed on the LCD, it means that there is insufficient power; please change the battery immediately in order to ensure its accuracy.
2. Do not place the meter in locations that have high temperature, humidity or that are exposed to direct sunlight.
3. Remember to turn off the power after usage; remove the battery if not used for a long period of time in order to prevent battery leakage and causing damage to internal components.
4. When the instrument failure, only by the authorized service provider or return the original repair.

## 8 Battery Replacement

1. Turn off the power.
2. Open the battery cover at the back of the meter, remove the batteries.
3. Please insert six new 9V batteries according to the polarities.
4. Put the battery cover back in place.

## 9 Product Disposal



Note: This symbol indicates that the meter and its accessories must be separated and processed properly.



## ***Warranty***

---

Triplett / Jewell Instruments extends the following warranty to the original purchaser of these goods for use. Triplett warrants to the original purchaser for use that the products sold by it will be free from defects in workmanship and material for a period of (1) one year from the date of purchase. This warranty does not apply to any of our products which have been repaired or altered by unauthorized persons in any way or purchased from unauthorized distributors so as, in our sole judgment, to injure their stability or reliability, or which have been subject to misuse, abuse, misapplication, negligence, accident or which have had the serial numbers altered, defaced, or removed. Accessories, including batteries are not covered by this warranty.

**Copyright © 2023 Triplett**

