

# Instruction Manual

**pH 700** pH/mV/°C/°F Bench Meter



**Ion 700** pH/mV/Ion/°C/°F Bench Meter



**OAKTON®**

**EUTECH  
INSTRUMENTS**

*Technology Made Easy...*

**ISO 9001**  
CERTIFIED

Part of Thermo Fisher Scientific

68X541701 Rev. 1 Jan 2010

# TABLE OF CONTENTS

<b>1. INTRODUCTION</b> .....	<b>1</b>
<b>2. GETTING STARTED</b> .....	<b>2</b>
2.1 Keypad Functions .....	2
2.2 LCD Annunciators .....	3
2.3 Meter Connections .....	3
<b>3. CALIBRATION</b> .....	<b>4</b>
3.1 pH Calibration .....	4
3.2 Temperature Calibration .....	5
3.3 Millivolt (mV) Offset Adjustment .....	6
3.4 Ion Calibration (Ion 700 Only) .....	6
<b>4. STORING AND RECALLING DATA</b> .....	<b>7</b>
<b>5. SETUP FUNCTIONS</b> .....	<b>8</b>
5.1 P1.0 CAL (Calibration) .....	8
5.2 P2.0 ELE (Electrode Information).....	8
5.3 P3.0 ConF (Configuration) .....	9
5.4 P3.1 rdY (Ready / Stability Indicator) .....	9
5.5 P3.2 °C°F (Celcius Or Fahrenheit).....	9
5.6 P3.3 buFF (pH Buffers & Calibration Points).....	10
5.7 P4.0 rSt (Reset) .....	10
5.8 P5.0 CLr (Clear Memory) .....	10
<b>6. TROUBLESHOOTING GUIDE</b> .....	<b>11</b>
<b>7. ION SELECTIVE ELECTRODES</b> .....	<b>13</b>
<b>8. SPECIFICATIONS</b> .....	<b>14</b>
<b>9. WARRANTY</b> .....	<b>15</b>
<b>10. RETURN OF ITEMS</b> .....	<b>15</b>

## 1. INTRODUCTION

Thank you for purchasing our pH 700 / Ion 700 series benchtop meter. These microprocessor-based meters are economical and simple to use. The design incorporates a large LCD for clear viewing, yet offers a small footprint to conserve space.

The pH 700 measures pH, mV (ORP), and temperature (°C or °F). In addition to these parameters, the Ion 700 features direct ion concentration measurement of various ions (mono and divalent).

Each meter includes a convenient slide-out card for quick reference.







Some configurations include an electrode arm and metal bracket which can be easily attached to the left or right side of the meter according to your preference.

The 700 series benchtop meters replace our popular 510 series meters that were introduced in 2000.

**We take great pride in every instrument we manufacture and hope this one serves you well.**

## 2. GETTING STARTED

### 2.1 Keypad Functions

	Powers the meter on and off. Upon power on, the meter automatically begins in the mode that was last used. Calibration and memory values are retained even if meter is unplugged.
	Toggle between available measurement modes; pH/Temp, mV/Temp, or ppm/mV (Ion 700 only). Also used to switch from pH to Temp during pH calibration mode. <b>Press and hold for 5 seconds to enter SETUP mode.</b>
	Toggles between measurement and calibration modes. In SETUP mode, returns user to the measurement mode.
	<b>MI</b> (Memory Insert) stores values into memory. ▲ Increase value. Scroll up in SETUP mode.
	<b>MR</b> (Memory Recall) recalls values from memory ▼ Decrease value. Scroll down in SETUP mode.
	Freezes measured reading. Press again to resume live reading.
	Confirms calibration values in CAL mode. Confirms selections in SETUP mode. View recalled values in memory mode.

## 2.2 LCD Annunciators

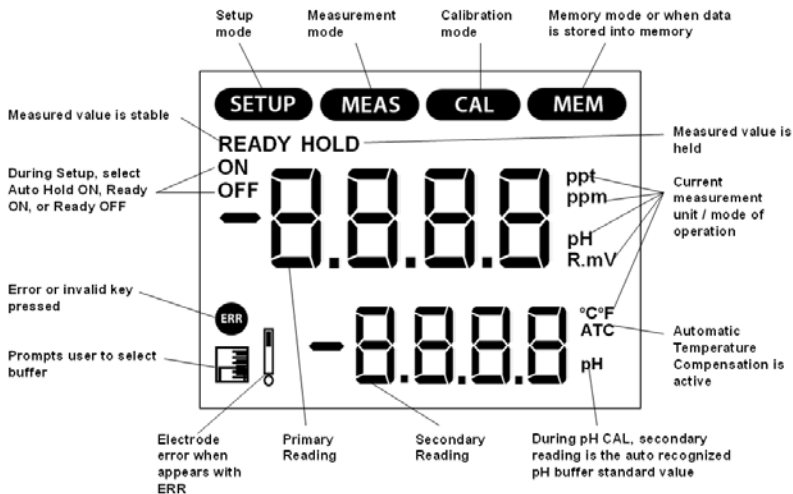

## 2.3 Meter Connections



<b>pH</b>	BNC connection for pH, ORP (Redox), or Ion Selective Electrodes (ISE).
<b>REF</b>	Pin connection for half cell reference electrodes. Requires separate half cell BNC electrode. Note: REF is not commonly used and is not required.
<b>ATC</b>	For Automatic Temperature Compensation probe.
<b>DC</b>	Power supply.

## 3. CALIBRATION

### 3.1 pH Calibration

For best results, periodic calibration with known accurate standards is recommended. Calibrate with standards that bracket your intended measuring range while including a neutral standard (pH 7.00 or 6.86). For example, if you expect to measure samples from pH 6.2 to pH 9.5, calibration with 4.01, 7.00, and 10.01 will work well.





The 700 series meters can be calibrated with up to 5 buffers. The non-volatile memory retains all calibration values upon meter shut down.

The following calibration standards are automatically recognized;

USA buffer group	1.68, 4.01, 7.00, 10.01, 12.45
NIST buffer group	1.68, 4.01, 6.86, 9.18, 12.45

See **Section 5.6** to change the buffer group

To eliminate temperature errors associated with the pH electrode, attach the automatic temperature compensation (ATC) probe for best accuracy. Without temperature compensation, pH accuracy will worsen as samples deviate from 25°C and pH 7.

- 1) Press  as needed to select pH.
- 2) Dip the pH and ATC electrodes into pH buffer and press . The secondary display will lock on the appropriate buffer value. Provide stirring for best results. When the **READY** indicator appears, press  to accept. The primary reading will flash briefly before the secondary display begins scrolling the remaining available buffers.
- 3) Rinse the pH and ATC electrodes then dip into the next pH buffer. The secondary display will lock on the appropriate buffer value. When the **READY** indicator appears, press  to accept. The primary reading will flash briefly then display the percent efficiency (slope) before the secondary display begins scrolling the remaining available buffers.

- 4) To calibrate another buffer repeat step 3) or press  to return to the measurement mode. **Note:** The meter will automatically return to measurement mode upon successful completion of the number of specified calibration points. To specify a different number of pH calibration points see **Section 5.6**.

Additional notes:







A single point (offset) calibration is only allowed with pH 7.00 or pH 6.86 buffers.

When the first calibration value is accepted during a new calibration, all prior calibration values are erased.

Press  at any time to abort calibration and return to measurement mode.







### 3.2 Temperature Calibration

The thermistor sensor used for automatic temperature compensation and measurement is both accurate and stable, so require frequent calibration isn't required. Temperature calibration is recommended upon electrode replacement, whenever the temperature reading is suspect, or if matching against a certified thermometer is desired.

- 1) Connect the temperature probe to the meter and place into a solution with a known accurate temperature such as a constant temperature bath. **Note:** To adjust the manual temperature compensation (MTC) value, do not connect the temperature probe.
- 2) Press  as needed to select pH or mV/R.mV.
- 3) Press  followed by . The primary display shows the measured temperature while the secondary display shows the factory default temperature.
- 4) Adjust the temperature using  or . Press  to accept or  to cancel. The meter allows an adjustable maximum value of  $\pm 5^{\circ}\text{C}$  (or  $\pm 0.9^{\circ}\text{F}$ ) from the factory default temperature.

### 3.3 Millivolt (mV) Offset Adjustment









Oxidization Reduction Potential (ORP or Redox) is not a precise measurement, but is useful as a relative indicator. As such, mV offset adjustment is not meant to enhance accuracy, but rather to make readings comparable to a reference. Commercial ORP solutions are often used as a check standard in which a meter/electrode system are verified to be close to a given value, instead of being used as a calibration standard in which adjustments are made in an attempt to match the ORP value.

- 1) Connect an ORP electrode and press  as needed to select mV (or R.mV).
- 2) Dip the ORP electrode into a solution with a known mV value (i.e. Zobel, Light's, quinhydrone, or iodidetriiodide) and stir.
- 3) Press  when the reading is stable. The primary display shows the relative millivolt value (R.mV) while the secondary display shows the factory default mV value.
- 4) Adjust the R.mV value using  or . Press  to accept or  to cancel. The meter allows an adjustable maximum value of  $\pm 150$  mV from the factory default mV value.

**Note:** When an offset has been stored successfully, R.mV replaces mV.

### 3.4 Ion Calibration (Ion 700 Only)







The Ion 700 can measure ion concentration such as ammonia or fluoride when using an ion selective electrode (ISE) for the specific ion of interest. The available ion calibration values are 0.10, 1.0, 10.0, 100.0, and 1000 parts per million (ppm). Choose a minimum of 2 consecutive values for calibration and prepare the corresponding ion calibration solutions. For best results always begin with your lowest standard value, followed by the next lowest standard.

- 1) Connect the ISE and press  as needed to select ppm. **Note:** The primary reading will show “- - -” without a stored ion calibration. The secondary value is the corresponding mV reading of the ISE.
- 2) Dip the ISE into your lowest standard solution value and stir. Press  when the secondary reading is stable.
- 3) Press  or  to match the primary display to your corresponding ion calibration value (0.10, 1.0, 10, etc).
- 4) Press  to accept or  to abort. The primary display will show the next highest calibration standard value.
- 5) Rinse the ISE then dip it into the corresponding calibration standard and stir.
- 6) Press  to accept or  to cancel. The mV/decade slope value will be displayed briefly if the calibration is successful. “SLP Err” indicates that the calibration for the current point was not successful. This occurs when the slope (mV difference between two consecutive points) is lower than 15mV/decade or higher than 90mV/decade.
- 7) Revert to step 3) to calibrate additional points or press  as needed to return to measurement mode at any time. **Note:** The meter will automatically return to measurement mode upon successful completion of the number of specified calibration points. To change the number of ion calibration points see **Section 5.6**.

## 4. STORING AND RECALLING DATA

The 700 series meters can retain up to 100 points into memory for later retrieval.

- 1) In the measurement mode, press  to insert the measured value into memory. The stored memory location value (StO) is briefly displayed.

- 2) To recall data from memory, press . The location of the most recent stored data is displayed first. Press  or  to select the location of the desired data, then press  to accept.
- 3) Press  to return to the stored data location. Press  to return to measurement mode. To erase stored data, see **Section 5.8**.

## 5. SETUP FUNCTIONS

Use the set up mode to customize your instrument operation. During measurement, press and hold  for 5 seconds to enter SETUP mode.

Press  or  to change programs or change options.

Press  to select the program or confirm selection.

Press  to go back a level or to return to measurement mode.

### 5.1 P1.0 CAL (Calibration)

Press  to view each stored calibration point.

### 5.2 P2.0 ELE (Electrode Information)

Press  to view mV offset (OFS) in mV and pH modes only.

Press  to view % slope (SLP) in pH and Ion modes only.

<b>Last Display Mode</b>	<b>Electrode Property</b>	
	<b>Offset</b>	<b>Slope</b>
pH	in mV	%
Ion	-	in mV
mV	in mV	-

**Note:** When multiple slopes exist, the slope that is available to view will depend on the measured value before entering SETUP mode. For example, if pH calibration values pH 4.01, 7.00 and 10.01 were completed, there will be two slope values; one that corresponds to pH values below 7.00 and another that corresponds to pH values above 7.00. If the measured pH value was 5.23 when setup mode was entered, the pH slope that corresponds to values lower than 7.00 will be available to view. If no calibration is stored, the offset will be 0.0 mV and the slope is 100%.

### 5.3 P3.0 ConF (Configuration)

Press  .

### 5.4 P3.1 rdY (Ready / Stability Indicator)

Press  .

Press  or  to choose READY "On", READY "OFF", or Auto HOLD.

Press  to confirm.

### 5.5 P3.2 °C°F (Celsius Or Fahrenheit)

Press  .



Press  or  to select °C or °F.

Press  to confirm.

## 5.6 P3.3 buFF (pH Buffers & Calibration Points)

Press .



Press  or  to select “USA” or “NIST” buffer group (pH mode only).



Press  or  to select number of Calibration Points (pH and Ion only).

Press  to confirm.

## 5.7 P4.0 rSt (Reset)

Press .



Press  or  to select “Yes” or “No”.

If “Yes”, press  or  to select “Cal” (calibration reset only) or “Fct” (complete reset to factory default settings).

Press  to confirm.



## 5.8 P5.0 CLr (Clear Memory)

Press .

Press  or  to select “Yes” (erase memory) or “No”.

Press  to confirm.

## 6. TROUBLESHOOTING GUIDE

PROBLEM	CAUSE	SOLUTION
No display	<ul style="list-style-type: none"> <li>a) Main power not switched on.</li> <li>b) AC Adapter socket not inserted properly.</li> </ul>	<ul style="list-style-type: none"> <li>a) Switch on the power supply.</li> <li>b) Re-insert AC Adapter &amp; press .</li> </ul>
Unstable reading	<ul style="list-style-type: none"> <li>a) Insufficient reference electrolyte in electrode.</li> <li>b) Broken electrode.</li> <li>c) External 'noises' or induction (e.g. electrical 'noise' caused by a nearby motor).</li> <li>d) Dirty electrode.</li> </ul>	<ul style="list-style-type: none"> <li>a) Fill electrode with reference electrolyte.</li> <li>b) Replace electrode.</li> <li>c) Remove or switch off interfering device.</li> <li>d) Clean &amp; rehydrate the electrode.</li> </ul>
Slow response	<ul style="list-style-type: none"> <li>a) Dirty electrode.</li> </ul>	<ul style="list-style-type: none"> <li>a) Clean &amp; rehydrate the electrode.</li> </ul>
Meter not responding to key press	<ul style="list-style-type: none"> <li>a) HOLD mode in operation.</li> <li>b) Bad keypad.</li> </ul>	<ul style="list-style-type: none"> <li>a) Press  to deactivate. See SETUP to disable Auto Hold feature if enabled.</li> <li>b) Contact Technical Service.</li> </ul>

ERR	CAUSE	SOLUTION
From any screen	Invalid key; Button does not work in the current operation mode.	Press alternate key. Select valid buttons depending on mode.
Ion CAL mode	Ion slope calibration error; calibration solutions are outside acceptable range (15 to 90 mV per decade).	Recalibrate using fresh ion solutions. Use required ISA. Replace electrode.
Ion CAL mode	Calibration points are more than 1 decade apart.	Recalibrate using consecutive calibration values 1 decade apart (ex. 1.0 and 10.0).
Ion CAL mode	Calibration attempted with only 1-point during ion calibration.	Recalibrate using 2 or more ion calibration points.
pH CAL mode	Calibration attempted using only 1-point that was not pH 7 (USA) or pH 6.86 (NIST).	Recalibrate using 2 or more pH points or use pH 7 (USA) or use pH 6.86 (NIST).
Err with electrode icon	Calibration error. Buffer value does not match value displayed or electrode is disconnected or failing.	Use fresh buffer solutions. Check electrode connection. Clean & recondition electrode. Replace electrode.
Ur (Under range) Or (Over range)	Measured value is out of range. Electrodes not connected. Electrode clogged, dirty or broken. Meter not calibrated. Wrong temp value.	Make sure electrode is connected. Clean or replace electrode. Recalibrate the meter. Treat samples to bring within meter measuring range. Reset meter.

## 7. ION SELECTIVE ELECTRODES

Contact our partners for more details regarding ISE and related solutions. The table below lists the most common electrodes available.

Ammonia (NH <sub>3</sub> )	Iodide (I <sup>-</sup> )
Ammonium (NH <sub>4</sub> <sup>+</sup> )	Lead (Pb <sup>+2</sup> )
Bromide (Br <sup>-</sup> )	Lithium (Li <sup>+</sup> )
Cadmium (Cd <sup>+2</sup> )	Nitrate (NO <sub>3</sub> <sup>-</sup> )
Calcium (Ca <sup>+2</sup> )	Nitrogen Oxide (NO <sub>x</sub> )
Carbon Dioxide (CO <sub>2</sub> )	Perchlorate (ClO <sub>4</sub> <sup>-</sup> )
Chloride (Cl <sup>-</sup> )	Potassium (K <sup>+</sup> )
Copper (Cu <sup>+2</sup> )	Silver / Sulfide (Ag <sup>+</sup> / S <sup>-2</sup> )
Cyanide (CN <sup>-</sup> )	Sodium (Na <sup>+</sup> )
Fluoride (F <sup>-</sup> )	Surfactant (X <sup>+</sup> , X <sup>-</sup> )
Fluoroborate (BF <sub>4</sub> <sup>-</sup> )	Water Hardness

## 8. SPECIFICATIONS

pH Range	0.00 to 14.00 pH
Resolution	0.01 pH
Accuracy	$\pm 0.01$ pH + 1 count
Calibration Points	Up to 5 points with Auto-buffer recognition
Buffer Options	USA : pH 1.68, 4.01, 7.00, 10.01,12.45 NIST: pH 1.68, 4.01, 6.86, 9.18 ,12.45
Slope Display	Yes (with offset)
mV Range	$\pm 2000$ mV
Resolution	0.1 mV ( $\pm 199.9$ mV), 1 mV beyond $\pm 200$ mV
Accuracy	$\pm 0.2$ mV ( $\pm 199.9$ mV), $\pm 2$ mV beyond $\pm 200$ mV
Offset Adjustment	Up to $\pm 150$ mV
Temperature Range	0.0 to 100.0 °C / 32.0 to 212.0 °F
Resolution	0.1 °C / °F
Accuracy	$\pm 0.5^\circ\text{C}$ / $\pm 0.9^\circ\text{F}$
Compensation	Automatic or Manual (0 to 100 °C / 32 to 212 °F)
Calibration	Offset in 0.1 ° increments; Offset range: $\pm 5$ °C / 9 °F
Ion Range	0.01 to 2000 ppm
Resolution (ppm)	0.01 (<1); 0.1 (1.0 to 199.9); 1 (>200)
Accuracy	$\pm 0.5\%$ FS (mono-valent) $\pm 1.0\%$ FS (di-valent)
Calibration Points	From 2 to 5 consecutive points; 0.1, 1.0, 10.0, 100.0 or 1000.0 ppm
Slope Range	15 mV/decade to 90 mV/decade
Memory	100 data sets
Inputs	BNC, ATC, Reference (Half-cell)
Power	AC/DC 9V, 6W Adapter (100/240 VAC, 50-60Hz)

## 9. WARRANTY

This meter is supplied with a warranty against significant deviations in material and workmanship for a period of THREE years from date of purchase whereas probe with a SIX month warranty.

If repair or adjustment is necessary and has not been the result of abuse or misuse within the designated period, please return – freight prepaid – and correction will be made without charge. Eutech Instruments/Oakton Instruments will determine if the product problem is due to deviations or customer misuse.

Out of warranty products will be repaired on a charged basis.

The warranty on your instrument shall not apply to defects resulting from:

- Improper or inadequate maintenance by customer
- Unauthorized modification or misuse
- Operation outside of the environment specifications of the products

## 10. RETURN OF ITEMS

Authorization must be obtained from our Customer Service Department or authorized distributor before returning items for any reason. A “Return Goods Authorization” (RGA) form is available through our authorized distributor. Please include data regarding the reason the items are to be returned. For your protection, items must be carefully packed to prevent damage in shipment and insured against possible damage or loss. Eutech Instruments will not be responsible for damage resulting from careless or insufficient packing. A restocking charge will be made on all unauthorized returns.

**NOTE:** Eutech Instruments Pte Ltd /Oakton Instruments reserve the right to make improvements in design, construction, and appearance of products without notice.