

QSTAR Fixed and Portable Ultrasonic Flowmeter (UFM)

Owner's Manual

Fixed



Portable



TABLE OF CONTENTS

Key Aspects of QStar UFM.....	3
Approvals/CE.....	3
Measuring Principle.....	3
QStar Fixed UFM and Components.....	4
QStar Portable UFM and Components.....	8
Operating.....	10
Getting Started.....	10
Preparing for Measurement.....	13
Measuring with UFM.....	15
Setup Parameters.....	15
Measuring Windows.....	31
Calibration.....	44
System Settings.....	44
Troubleshooting.....	46
Software Update.....	53
Fluid Properties.....	54
Specifications.....	56



Text identified with an exclamation mark contains important information that relates to the basic data and operation of the device.



Text identified with the letter "i" contain supplementary and helpful information.

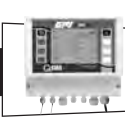

FIXED UFM

Text contained within this box applies specifically to the QStar FIXED UFM. If you have a PORTABLE UFM, skip this section and go to the text with no border, or the text in the PORTABLE UFM box.



PORTABLE UFM

Text contained within this box applies specifically to the QStar PORTABLE UFM. For a FIXED UFM, skip this section and go to the text with no border, or the text in the FIXED UFM box.

FIXED UFM

PACKAGE INCLUDES:

- Transmitter
- Ultrasonic transducers
- Spacer bar for the ultrasonic transducers (for types F10/F21)
- Stainless steel mounting belts
- Getting Started ("Quick-start") manual
- USB drive with Owner's Manual
- Ultrasonic coupling grease

Other ultrasonic transducers for smaller or larger pipe dimensions, as well as clamp-on temperature sensors, are available on separate order. Contact GPI at www.GPIometers.net or toll-free (888) 996-3837.

PORTABLE UFM

PACKAGE INCLUDES:

- Hard-shell case
- QStar Portable flow transmitter
- Plug-in power adapter, plus IEC appliance power cable
- Transducer cables
- Ultrasonic transducers
- Spacer bar for the ultrasonic transducers
- Cable for the 4 mA to 20 mA analog output (Mini DIN, alligator clips)
- Digital output cable for the relay/pulse output (Mini DIN, alligator clips)
- USB cable
- Stainless steel mounting chains (up to 16 in.)
- Getting Started ("Quick-start") manual
- USB drive with operating instructions
- Ultrasonic coupling grease
- Measuring tape

Other ultrasonic transducers for smaller or larger pipe dimensions and clamp-on temperature sensors, are available on separate order. Contact GPI at www.GPIometers.net or toll-free (888) 996-3837.



KEY ASPECTS OF QSTAR UFM:

- Fixed or Portable system for measuring liquids in filled piping systems.
- Uses the ultrasonic transit-time differential method.
- Heat measurement is included as standard application. Clamp-on Fixed and Portable temperature sensors are optional.
- Portable UFM can be operated in battery-powered mode and on a power adapter for operation with 100% duty cycle. Fixed UFM can be operated on a power adapter.
- Supports measurements on piping with diameters from 1/2" to 240" (depending on the sensor used).
- The fluid to measure may have a temperature range from -40° F to +300° F (depending on the transducer used).
- You can save the measuring data to the internal SD card, read the data via USB port and export this data using Microsoft® office software such as Excel (Portable UFM only).
- The device is equipped with an electrically isolated relay output and two 4mA to 20mA current outputs that can be operated in active and passive mode.

APPROVALS/CE



QStar UFM is compliant with the following European Directives and Standards

Test Specifications			
DIN	EN	55011 B	(11/2007)
DIN	EN	61000-4-2	(09/2008)
DIN	EN	61000-4-3	(06/2008)
DIN	EN	61000-4-4	(07/2005)
DIN	EN	61000-4-5	(06/2007)
DIN	EN	61000-4-6	(10/2008)
DIN	EN	61000-4-8	(12/2001)
DIN	EN	61000-4-11	(02/2005)

Test Requirements			
DIN	EN	61000-6-1	(10/2007)
DIN	EN	61000-6-3	(09/2007)

ULTRASONIC MEASURING PRINCIPAL

FIGURE 1: Measuring Principle

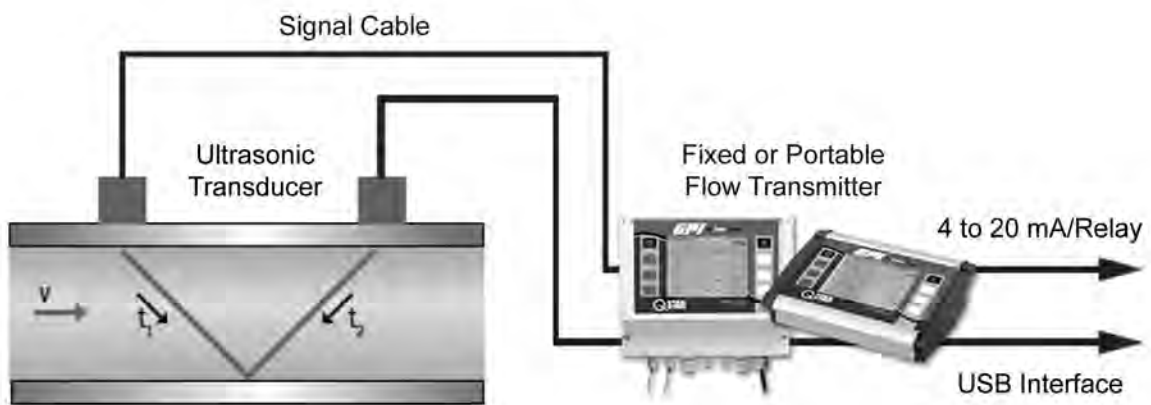

Flow measurement according to the ultrasonic transit time method - precise and reliable.

The UFM employs precise, ultrasonic transit-time differential method. This method involves installation of two ultrasonic transducers on the surface of the piping and their interconnection with the electronic evaluation system. The ultrasonic transducers operate in alternating mode as transmitter and receiver with cyclic exchange of ultrasonic signals. Measurements cover the transit times of the upstream and downstream signals (t1, t2). The UFM measures the transit-time differential of the ultrasonic signals t1 and t2 that travel upstream and downstream. These signals are accelerated (t1) or retarded (t2). The difference that develops between both signal transit times is proportional to flow velocity and is used in combination with the piping geometry data for precise calculation of the volumetric flowrate.

$$\bar{v} = L \frac{(T2 - T1)}{T1 \cdot T2 \cdot 2 \cos \alpha}$$

Calculation of flow velocity [m/s]

$$Q = L \frac{(T2 - T1)}{T1 \cdot T2 \cdot 2 \cos \alpha} \cdot \frac{D^2}{4} \cdot \pi$$

Calculation of flowrate [m3/s]

The flow transmitter uses a sophisticated cross-correlation to detect signals. This ensures a reliable detection of signals even in case of harsh circumstances like gas and/or particle load.

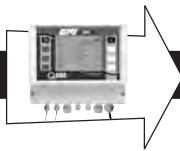

FIXED UFM AND COMPONENTS

FIGURE 2: UFM – with Mounted Ultrasonic Transducers (Bottom) and Flow Transmitters



The UFM consists of the ultrasonic transducers and the flow transmitter that are mounted onto piping.

FLOW TRANSMITTER

FIGURE 3: Flow Transmitter



The flow transmitter processes the signals and makes the measurement results available to the user.

ULTRASONIC TRANSDUCERS

The ultrasonic transducers are mounted onto the piping and transmit and receive the ultrasonic signals that are used in the flow transmitter to calculate the volumetric flowrate.

Ultrasonic transducers:

QMF-F10 (1 MHz) for pipe diameters 1.25" to 16"

QMF-F21 (2 MHz) for pipe diameters 3/8" to 4"

Operating temperatures: -40° F to 300° F

FIGURE 4: Ultrasonic Transducers (F10/F21) typically used with Spacer Bar (not shown)



Ultrasonic transducer:

QMF-F05 (0.5 MHz) for pipe diameters 8" to 240"

Operating temperatures: -40° F to 180° F

(300° F optional on request)

FIGURE 5: Ultrasonic Transducers (Type F05)



MOUNTING MATERIAL AND ACCESSORIES

Signal cables

Signal cables are a part of the ultrasonic transducers and cannot be separated from transducers.

Spacer bar for transducer mounting

For transducers F10 and F21 (Transducer QMF-F05 is mounted on pipes using textile tape rather than spacer bar).

FIGURE 6: Spacer bar



Metal Mounting Belt for Transducer Mounting

FIGURE 7: Mounting Belt (Stainless Steel)



FIGURE 8: Transducers Mounted with Spacer Bar and Mounting Belts



Coupling grease



Apply the ultrasonic coupling gel between the ultrasonic transducer and the piping in order to optimize signal input.

QMF-PT100 Temperature sensors

The clamp-on temperature sensors collect temperature data in heating and cooling circuits. This data is then used to calculate heating and cooling quantities.

FIGURE 9: Clamp-on temperature sensors, QMF-PT100 (optional)



FIGURE 10: QMF-PT100 (optional) Temperature Sensor Mounted with Metal Belt



Interfaces of UFM

Open the cover to access the connecting terminals.

FIGURE 11: Front view of transmitter showing cover

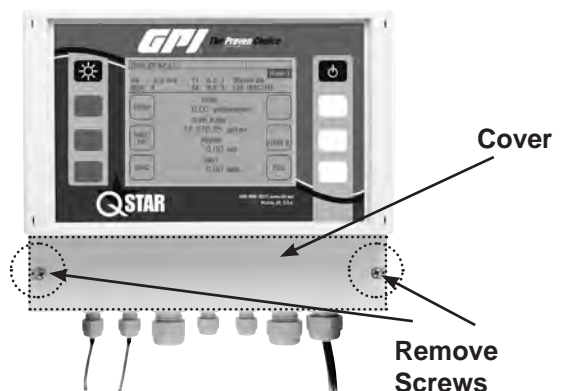

CONNECTOR BOARD

FIGURE 12: Connecting Terminals

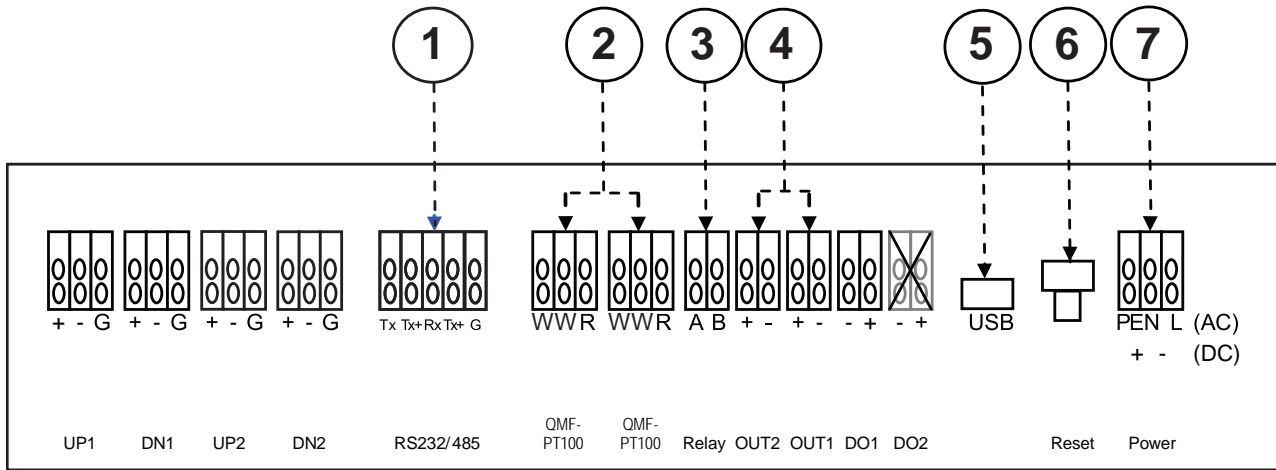

1 RS232/RS485 Interface boards

Digital Interface boards RS232 or RS485 are available as an option to provide digital communication via ASCII strings.

2 Input for temperature sensors QMF-PT100 (3-wire)

The two temperature sensors (feed and return pipe) can be connected in order to measure heat/thermal output. The flow transmitter always includes the capability for heat/thermal output measurement. Note that (if required by customer) the QMF-PT100 inputs can also be used to reset the counters. If you use this reset function you cannot measure heat/thermal output at same time.

3 Relay output (potential-free)

This output is potential-free NO (normally open) relay output. Use this output to establish an alarm (for example, when exceeding a certain flow speed).

4 Analog output 4-20mA (active)

The 4-20mA outputs can be used to submit measurement data like flow, thermal output and velocity to the Programmable Logic Controller (PLC). These outputs are in active mode (supply voltage provided internally by flow transmitter).

5 USB- Interface

Used for firmware updates. Standard USB (micro USB)- cable required to connect to a PC.

6 Hardware Reset

Used to reset unit (for hang-ups).

7 Power Supply

Location for connecting the supply voltage. QStar UFM is available as AC (90-240VAC) and DC (18-36VDC) version.

⚠ CAUTION

Always use the correct voltage for the UFM. Improper supply voltage might seriously damage the flow transmitter. Check the type of power supply on the name plate (printed on right side of enclosure of flow transmitter).

Wiring

The connection terminals are located under the lower cover. Remove the two screws and plastic cover to gain access to the connection terminals.

FIGURE 13: Accessing the Connection Terminals





Use cables with 16-26AWG wires. Wires should be stripped about .5 in. to allow proper contact to terminals.

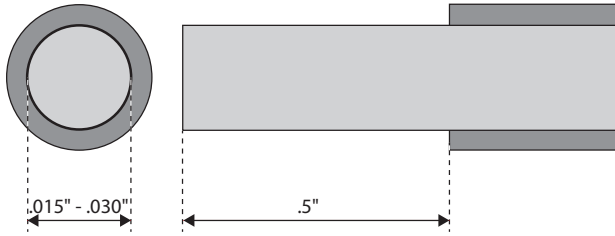

Put the stripped end of the related wire into the related hole. Wires will be held by spring. It might be helpful to use end sleeves or tin the wire ends.

FIGURE 14: Connection Terminals – Fasten Cables

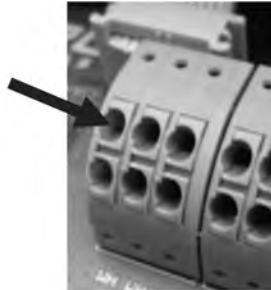

Use a slotted screwdriver to unfasten wires, then press middle part between the two holes as shown to loosen the spring and remove the wires.

FIGURE 15: Connection Terminals - Unfasten Wires



AC TERMINAL BLOCK WIRING

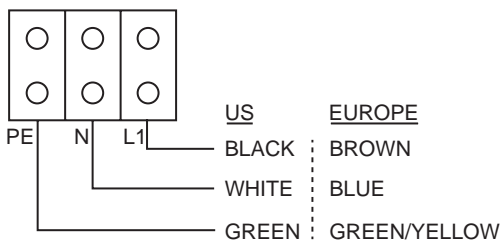

Terminal Diagram

Terminals	Designation
UP1	Connection of upstream transducer Red wire to be connected to + Black wire to be connected to -
DN1	Connection of downstream transducer Red wire to be connected to + Black wire to be connected to -
UP2	Connection of upstream transducer (path2) Red wire to be connected to + Black wire to be connected to -
DN2	Connection of downstream transducer (path2) Red wire to be connected to + Black wire to be connected to -
RS485	Optional Interface board
QMF-PT100	Connect temperature sensors (measuring colder temperature) to left QMF-PT100 terminal WH = White wire from QMF-PT100 RD = Red wire from QMF-PT100
QMF-PT100	Connect temperature sensors (measuring warmer temperature) to right QMF-PT100 terminal WH = White wire from QMF-PT100 RD = Red wire from QMF-PT100
Relay	Relay output, external voltage required
OUT1	Analog output1, 4...20mA, active, voltage provided internally
OUT2	Analog output2, 4...20mA, active, voltage provided internally
DO1	Digital output (Transistor), passive mode, external voltage required.
DO2	Optional, Digital output 2
Power Supply	Either DC (18-36VDC) or AC (90-240VAC). Check order confirmation or name plate on flow transmitter for operating voltage.

CAUTION

- The 4-20mA outputs are set in active mode. That means the required voltage is provided by flow transmitter internally. DO NOT USE additional external voltage.
- The digital output is set in passive mode and requires external voltage to be operated.
- Relay is rated to max. 45V, 0.25mA. These values must not be exceeded.

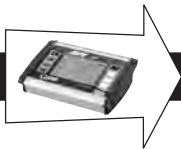

PORTABLE UFM AND COMPONENTS

PORTABLE FLOW TRANSMITTER

Your UFM consists of the ultrasonic transducers and the flow transmitter that are mounted onto your piping.

The flow transmitter processes the signals and provides the measurement results.

FIGURE 16: PORTABLE Flow Transmitter (Top) and Mounted Ultrasonic Transducers (Bottom)



ULTRASONIC TRANSDUCERS

The ultrasonic transducers mount onto the piping to transmit and receive the ultrasonic signals used in the flow transmitter to calculate the volumetric flowrate.



Ultrasonic transducer QMP-F21 (2 MHz), RED housing, for pipe diameters from 0.5 to 4.0 inches. Operating temperatures: -40° F to 300° F



Ultrasonic transducer QMP-F10 (1 MHz), BLUE housing. Pipe diameters: 1.5 to 16 inches. Operating temperatures: -40° F to 300° F



Ultrasonic transducer QMP-F05 (0.5 MHz), GREEN housing. For pipe diameters from 8 to 240 inches. Operating temperatures: -40° F to 176° F (300° F optional on request)

MOUNTING MATERIAL AND ACCESSORIES

Signal cables



Spacer bar for transducer mounting

For QMP-F10 and QMP-F21 (QMP-F05 is mounted on pipes using textile tape rather than spacer bar).

FIGURE 17: Spacer bar



Chains for Transducer Mounting

FIGURE 18: Mounting Chain (Stainless Steel)



FIGURE 19: Transducer QMP-F05 (500 kHz) for large pipes – Mounting with textile tape.



Coupling grease



Apply the ultrasonic coupling gel between the ultrasonic transducer and the piping to optimize signal input.

QMP-PT100 Temperature sensors (Optional)

The clamp-on temperature sensors collect temperature data in heating and cooling circuits. Use this data to calculate heating and cooling quantities.

FIGURE 20: QMP-PT100 clamp-on temperature sensors



4-20mA analog output cable



The analog output cables can be used to connect an external data logger or recorder to the flow transmitter for the transmission of measured values such as flowrates, or thermal output.

Cable for Relay/Pulse



The relay connecting cable can be used to trigger alerts. For example, when exceeding a certain flowrate.

Power adapter 100-240V, 47-63Hz, 1A



The power adapter is normally used to charge the battery. Your UFM supports permanent operation by using the power adapter.

FIGURE 21: Back view of Portable UFM connections

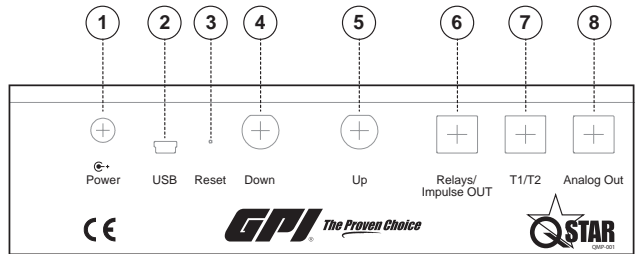

- 1 Power Input**
This jack is used to connect the plug-in power adapter that is included with the UFM package.
- 2 USB Interface (Mini.USB Type B)**
Enables access to the integrated SD memory card from a PC. This card is used to store data logging information and measurement data (LOG files). Windows XP or later versions detect the internal SD Card as mass storage medium. No need to install additional drivers.
- 3 Hardware Reset**
Use a small screwdriver (or paper clip) to press the reset button.
- 4/5 BNC Inputs for Ultrasonic Transducers**
Jacks for the ultrasonic transducers.
- 6 Relay/Pulse Output (4-Pol Mini DIN)**
Electrically isolated output with NO (normally open) contact. This internal NO contact is open unless an actuating signal is generated. Allows user to assign alarm or threshold limit functions to this output.
- 7 Input for Temperature Sensors QMP-PT100 (6-Pole Mini DIN)**
Receptacle for the optional temperature sensors that enable the use of the internal heat measurement function of the UFM.
- 8 4-20mA Analog Output (5-Pol Mini DIN)**
These outputs can be assigned variables such as the flowrate and return a current that is proportional to the value of the variables. The outputs operate in active (power provided by flow transmitter) 2-wire mode.

SAFETY INSTRUCTIONS

- The flow transmitter cannot be operated outside the temperature range from -4° F to 140° F.
- The ultrasonic transducers are sensitive to mechanical stress such as impact and vibration. Always safeguard the transducers against strong vibration or impact to avoid damage or destruction.
- The plug-in power supply is suitable for in-door use only.
- The plug-in power adapter or the power cable must be replaced completely in the case of mechanical or electrical damage.
- The flow transmitter is not approved for operation in hazardous locations. The standard ultrasonic transducers are not approved for operation in hazardous locations.
- The ultrasonic transducers may not be operated outside their specified fluid temperatures.

OPERATING

CONTROL BUTTONS

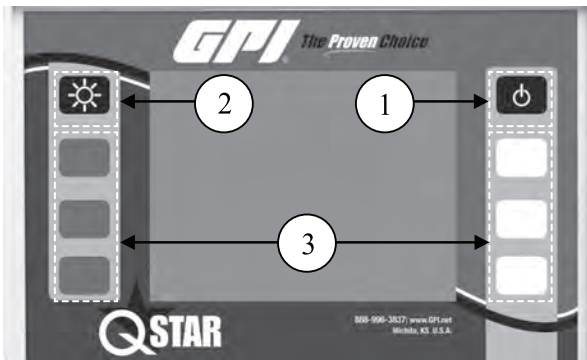

1. Turns on Portable transmitter. Fixed transmitter will automatically start when connected to voltage supply.
2. Switches the backlight On and Off.
3. Multifunctional buttons: Use this button to select the function that is displayed next to it on the screen.

HOW TO NAVIGATE

Use the corresponding multifunctional buttons:

				Arrow buttons for navigation
	Confirms entry			
	Confirms entries and opens the next window			
	Returns to the previous window			
	Increases the value			
	Reduces the value			
	Activates a certain function (depending on chosen menu)			
	No function			

GETTING STARTED

BASIC SETTINGS, MAIN MENU, NAVIGATION

Setting Language

1. Switch on the device. During the start sequence, press the multifunctional button that is located next to the "SETUP" field.

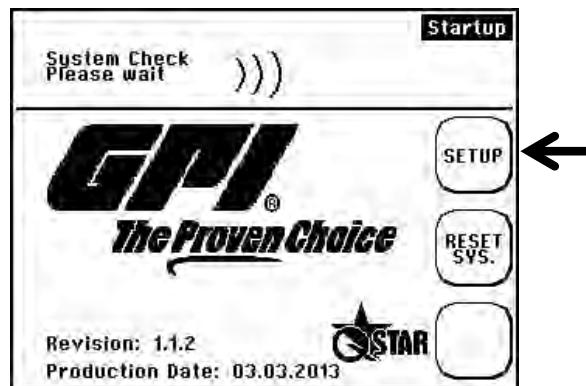

2. Confirm the "SETUP LANG." button

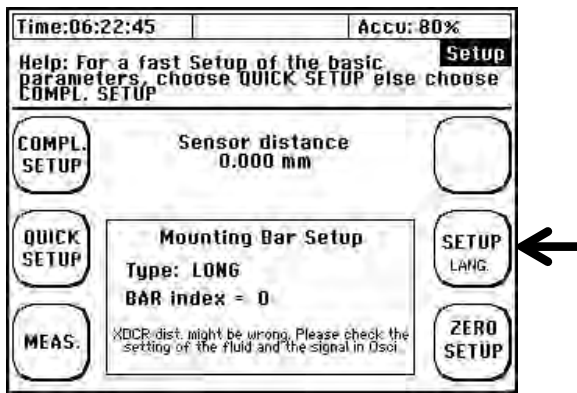

2. Select "COMPL Setup" when window appears.

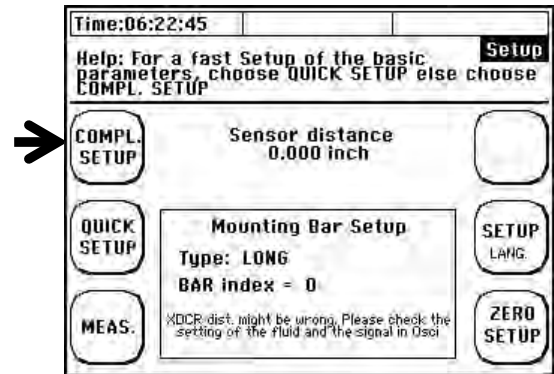

3. Use the arrows in the next window to select the dialog language. Confirm entry with "Enter". Exit the menu with "SETUP."



You are now in the main menu. Select all necessary functions of the device in this menu.

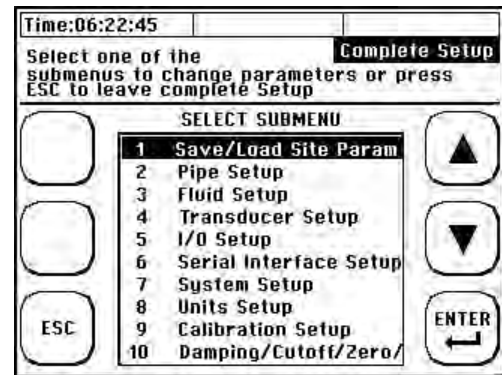

To return to the measuring window, proceed as follows: Select "ESC" -> "MEAS" in the next window.

CAUTION
The language setting selects the language used in the menus. The language in the fields next to the multifunctional button remains unchanged.

i To accelerate access to the main menu after power on, select the start sequence "SETUP." Select "COMPL SETUP" in the next window.

Setting the Time and Date

After selecting the dialog language, the setup menu opens.

Navigation in Main Menu "Flow 1"

The "Flow 1" measuring window is automatically opened with a delay of a few seconds after turning on the power. The "Flow 1" measuring window provides an overview of all data that is necessary for flow and optional heat measurements.

1. Scroll the "System Setup" menu command using the arrow keys.

1. Select "Setup"

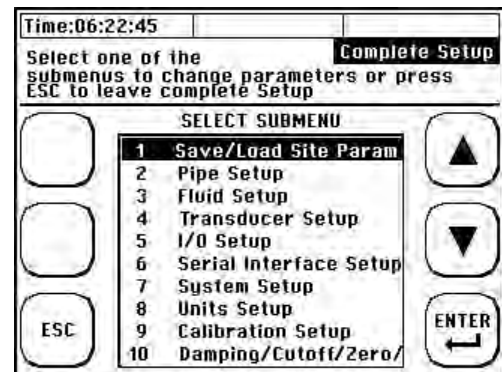
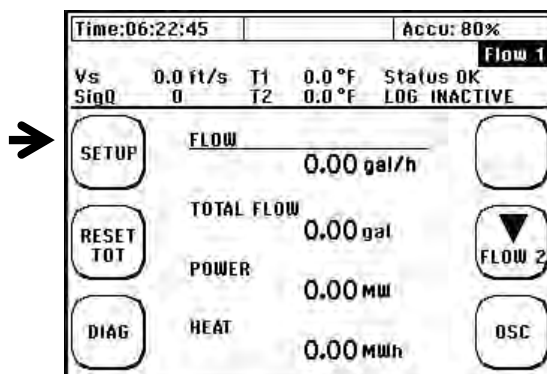

2. Select the "Time and Date" menu command

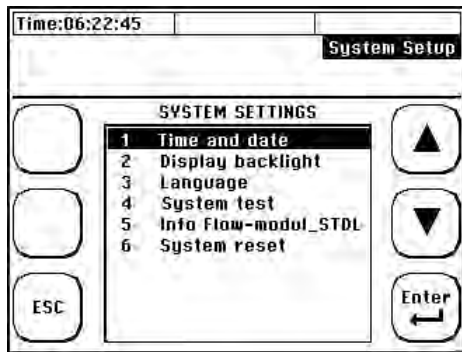

3. Enter the time as: **Hour (hh): Minute (mm): Second (ss)**.
Enter the date as: **Month (mm): Day (dd): Year (yy)**.

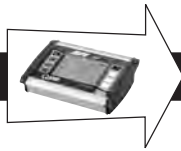
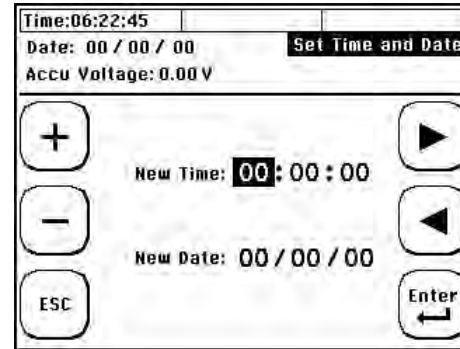

APPLIES TO PORTABLE QSTAR

The status bar is located in the uppermost row of the display.



Time

Displays the current time (system time). The time stamp that is derived from the system time will be applied to the measurement data.

SD memory

Displays the free space on the internal SD memory card of the device (standard is 2 GB).

Backup battery

Provides information about the status of the rechargeable battery.

- **Load:** The device is powered using the power adapter while the battery is charged. The empty battery needs a charging time of approximately five hours.
- **Full:** The battery is in a charged state. The device may be operated for approximately five hours when the display backlight is switched off or for approximately three hours when it is switched on.

Percentage display

Displays the charging state of the battery.

The times specified applies to a new battery. The factual operating/load cycles may deviate from the specified time values.

PREPARING FOR MEASUREMENT

The following section elaborates on essential aspects that must be taken into account for successful flowrate measurements.

STRAIGHT RUN REQUIREMENTS

The selection of the mounting location has a significant impact on measurement quality. The charge and discharge areas listed in the following table should be taken into account.

FIGURE 22: Straight run requirements

Classification	For upstream side	For downstream side
90° bend		
Tee		
Diffuser		
Reducer		
Valves		
Pump		

TRANSDUCER MOUNTING POSITIONS

Mounting Ultrasonic Transducers

⚠ CAUTION

The pipe must always be filled completely at the mounting positions of the ultrasonic transducers. It is not possible to take measurements on partially filled pipe.

The ultrasonic transducer can be operated in any mounting position. However, conforming with the mounting positions shown below is mandatory. The drawing shows the side view of the piping.

Mounting Ultrasonic Transducers On Horizontal Pipe

FIGURE 23: Preferable mounting positions for ultrasonic transducers (1)

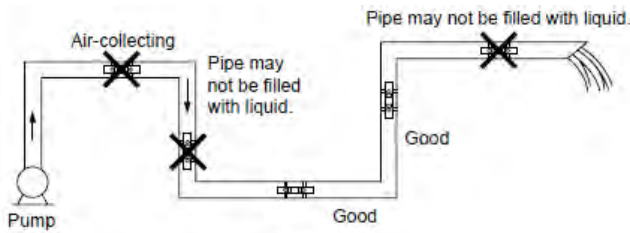

On horizontal piping, mount the transducer with an offset of about +/-45% to the horizontal plane. Otherwise, there is a risk of the accumulation of bubbles in the upper section and sedimentation in the lower section of the pipe.

FIGURE 24: Preferred mounting positions for ultrasonic transducers (2)

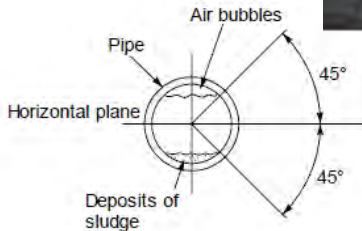
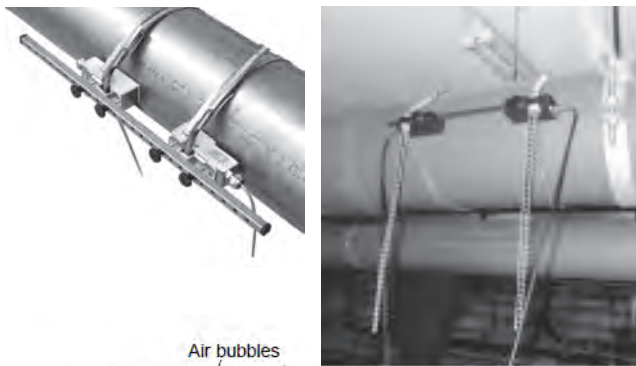

UFM uses the cross section of the pipe to calculate the flow. The cross section is calculated from the inner diameter setup (user setting). If there is sedimentation in the pipe, which decreases the real inner diameter, a small amount of uncertainty may result. The same happens when the inner diameter is not known/estimated.

$$Q = L \frac{(T2 - T1)}{T1 \cdot T2 \cdot 2 \cos \alpha} \cdot \frac{D^2}{4} \cdot \pi$$



To measure pipes with unknown wall thicknesses a wall thickness gauge is available from GPI. Ask GPI Customer Service Representative for more information or visit www.GPIimeters.net.

Ultrasonic Transducers On Non-Planar Surface

Never mount the transducers on non-planar surfaces such as welding seams or deformations. Always try to remove thick and uneven protective paint coating from the piping area where the ultrasonic transducers will be mounted.

Mounting Ultrasonic Transducers

Following are the options for mounting the ultrasonic transducers. The V-mode is standard for most applications.

V-Mode

FIGURE 25: Mounting of transducers in V-mode

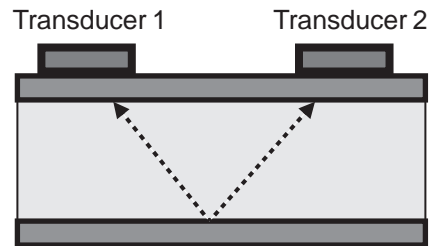

In the V-mode, both ultrasonic transducers are mounted onto the same side of the pipe. This mode is the standard for small and medium pipe dimensions. The ultrasonic signals are reflected from the pipe wall.

W-Mode

FIGURE 26: Mounting of Transducers in W-Mode

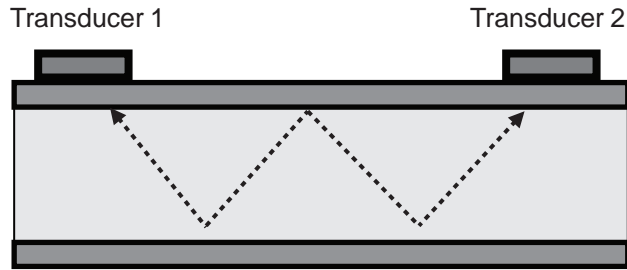

The W-mode is a special method for mounting the ultrasonic transducers. This method is usually employed on very small pipes.

Z-Mode

FIGURE 27: Mounting of Transducers in Z-Mode

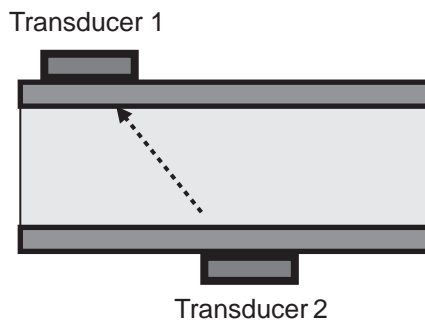

The Z-mode is a special method for mounting the ultrasonic transducers. The signal is transmitted across a shorter distance with this installation method. Use for measuring large-scale piping systems, or where the system is filled with heavily contaminated or gas-loaded fluid.

SETUP PARAMETERS

This section defines the input of all data that is necessary for flow measurement.

- **“QUICK SETUP”**: The Quick Setup guide offers step-by-step instructions on the essential tasks required to setup parameters.
- **“COMPL SETUP”**: The complete setup function enables access to all options and expert settings.

WHAT NEEDS TO BE SETUP

- The pipe's outer diameter or circumference.
- The wall thickness of the pipe. The material and thickness of the pipe lining, if such lining exists.
- The pipe material
- The fluid
- The type of ultrasonic transducers
- The mounting mode for the ultrasonic transducers



Ultrasonic measurement is based on the signal transit time process. The ultrasonic signals penetrate the piping and the fluid. In order to calculate the signal transit time, each fluid, piping material and existing lining will be assigned a sonic speed value, as well as the pipe diameter or circumference value. The tabular database specifies the sonic speed values for the materials and fluid. The sonic speed for materials not listed in the tables must be entered manually. Tables that list additional sonic speed parameters for different materials are available in the back of these operating instructions.

MEASURING WITH UFM

5 Steps to Flow Measurement:

- Select a suitable location for mounting the ultrasonic transducers
- Setup the UFM pipe parameters
- Mount the ultrasonic transducers onto the piping
- Perform a zero calibration
- Start the flow measurement

USING QUICK SETUP

Accessing the setup dialog:

After power on: Select "Setup" -> "Quick Setup" within the start sequence.

In the primary measuring window "Flow 1": Select "Setup" -> "Quick Setup."

Enter the kinematic viscosity of the fluid:

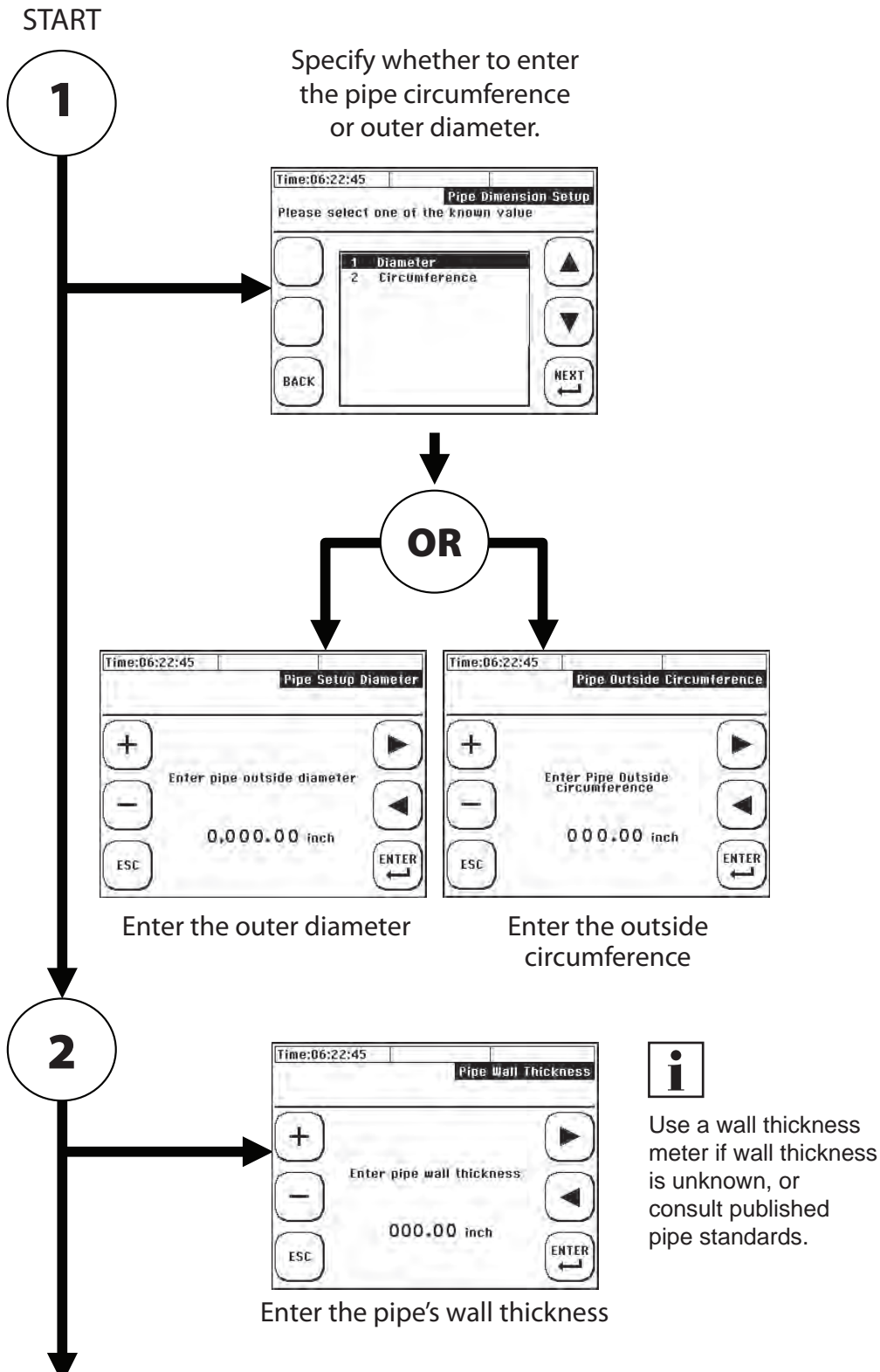

USING QUICK SETUP (CONTINUED)

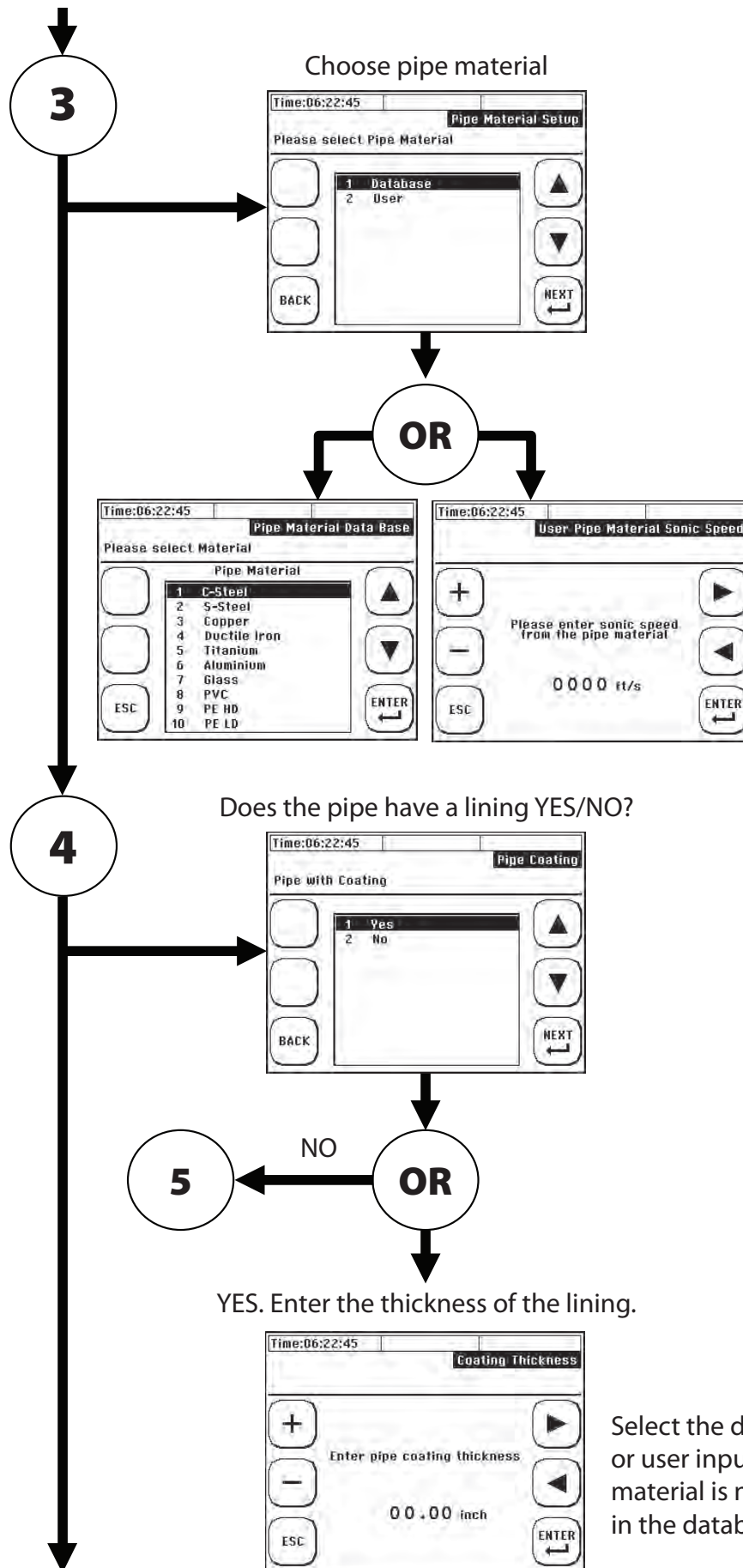

Select the database, or user input if a material is not listed in the database.

USING QUICK SETUP (CONTINUED)

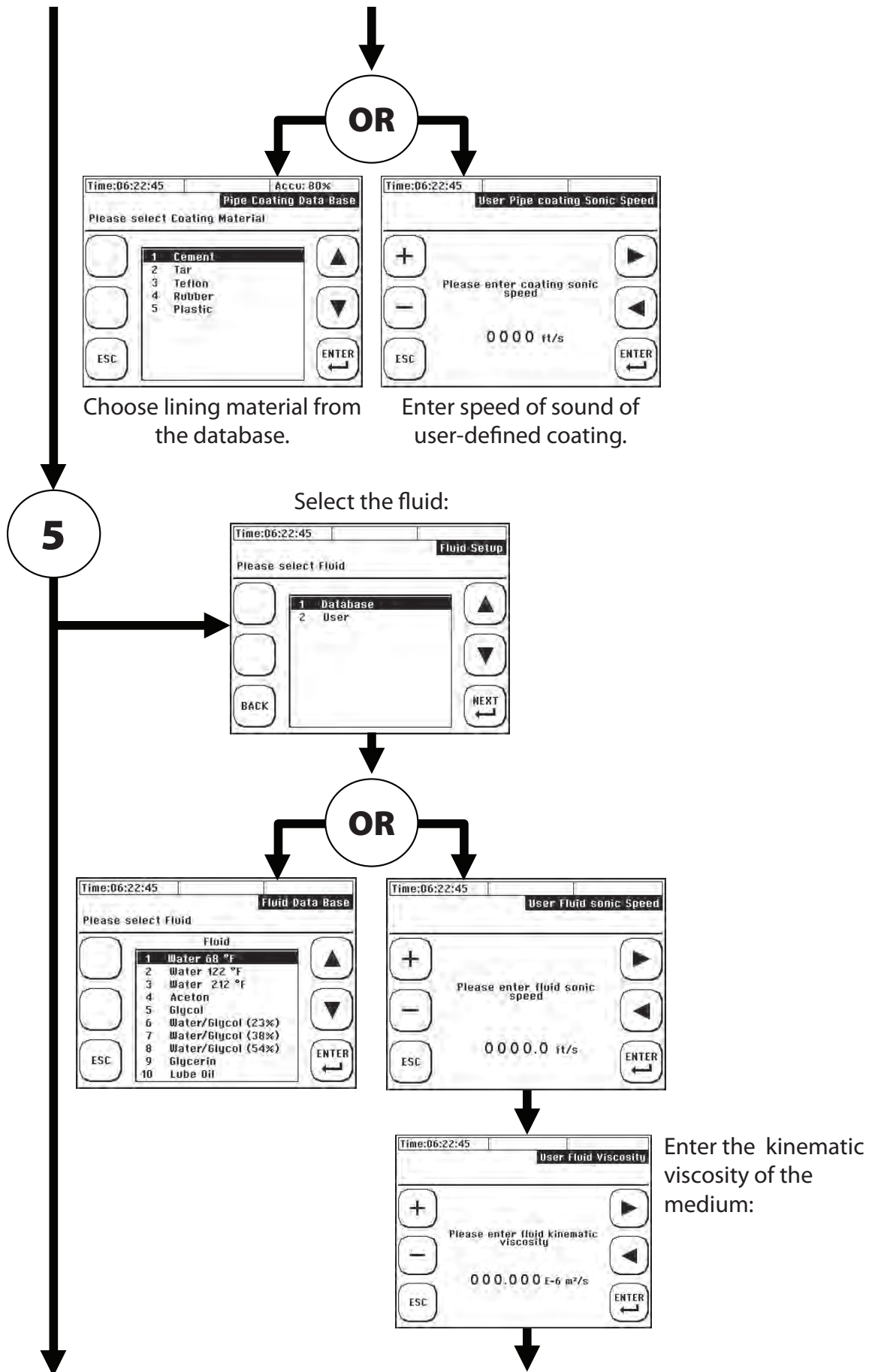

USING QUICK SETUP (CONTINUED)

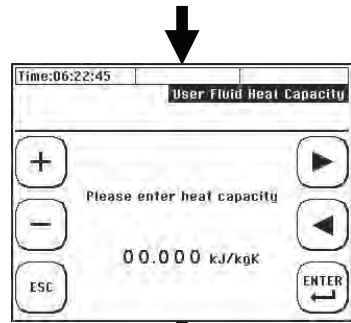
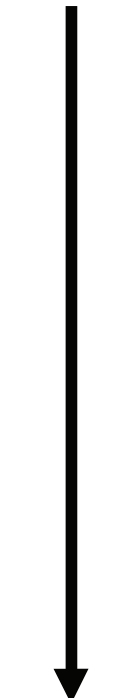

Enter the thermal capacity of the fluid:

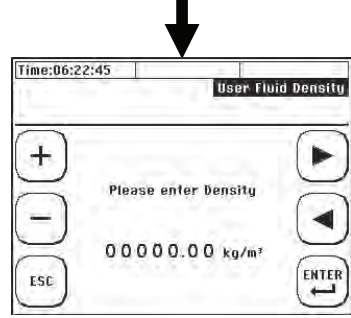

Enter the density of the fluid:



Select a suitable ultrasonic transducer:



For information on suitable transducers for specific pipe dimensions, refer to section "QStar UFM and Components."



Select a suitable mounting mode:

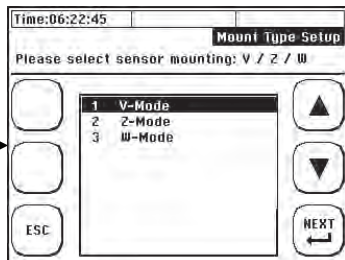

For information on suitable transducers for specific pipe dimensions, refer to section "QStar UFM and Components."

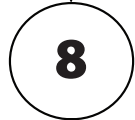

Output of the distance between the ultrasonic transducers:

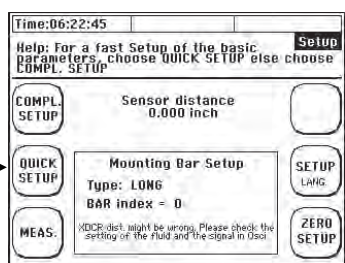

The distance between transducers is specified in inches and always measured between the faces of transducers 1 and 2. These dimensions are not the same for each mounting mode.

END

MOUNTING DISTANCE

The distance between the ultrasonic transducers is always measured between their opposing surfaces in all mounting modes. After setting up the measuring point, the flow transmitter displays the distances that have to be set up using a measuring tape. When using a spacer bar in the V-mode, position the transducers conveniently using the spacer bar.

V-mode and W-mode

FIGURE 28: Mounting of ultrasonic transducers V-mode

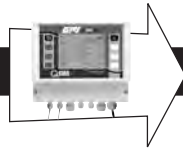
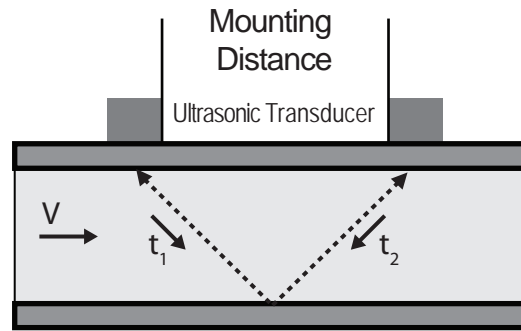

APPLIES TO FIXED UFM

FIGURE 29: V-Mode or W-Mode with Spacer Bar



FIGURE 30: V-Mode Mount with Fabric-Reinforced Tensioning Tapes for Large Pipe Diameters



Installation at Z-Mode

FIGURE 31: Mounting of ultrasonic transducers (Z-mode)

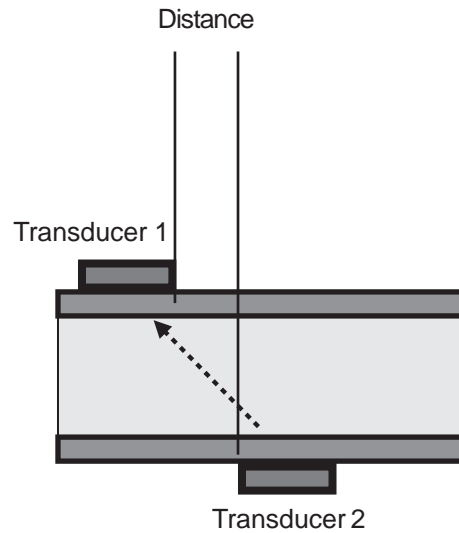

FIGURE 32: Mounting of ultrasonic transducers in Z-mode using mounting belts

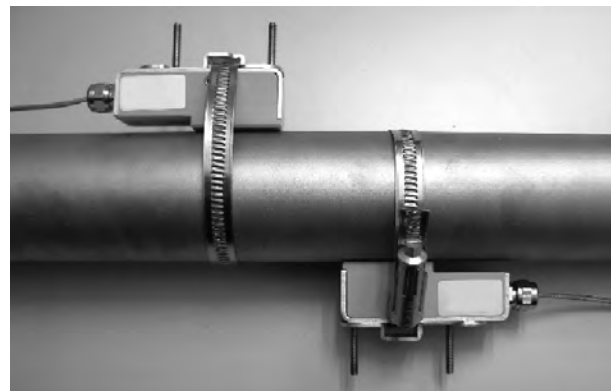

FIGURE 33: Z-mode installation with fabric-reinforced tensioning tapes for large pipe diameters



ULTRASONIC TRANSDUCER MOUNTING

The ultrasonic transducer (F10 and F21) is made of plastic (PEEK) that has a beige color and is protected by means of a metal sheath. The sheath has two threaded bars on top that prepares the transducer for use of spacer bar.

The ultrasonic transducer type F05 consists only of the sensor sheath and the ultrasonic transducer.

FIGURE 34: View of the back side of the transducer. Some coupling grease (approximately the size of a peanut) has to be applied where the part touches the pipe wall after installation.

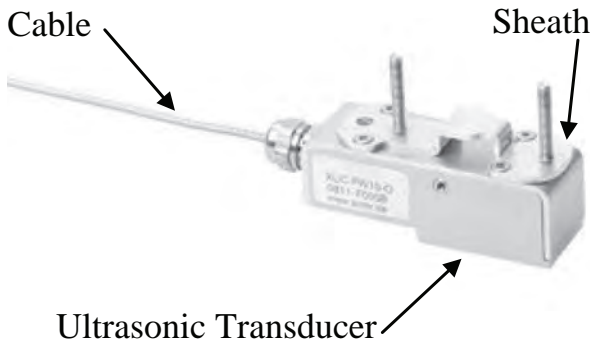
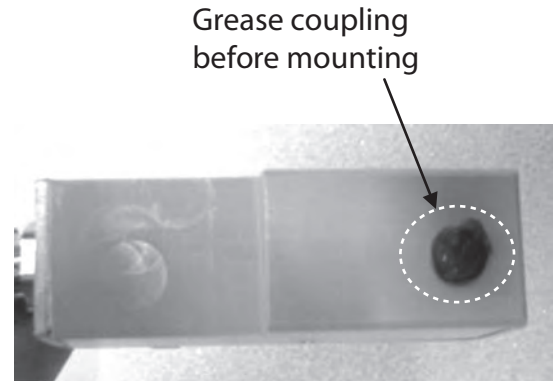

FIGURE 35: Lower side of ultrasonic transducer (touching pipe wall)



Mounting in V-mode or W-mode

After setting up the parameters of the measuring point, the flow transmitter displays the distance between the transducers in inches (face-to-face, see Figure 36) and as number of grid holes for use of the spacer bar (ultrasonic transducers type F10 and F21). Bar index number 4, for example, shows three free grid holes between the ultrasonic transducers. Install the transducers on the spacer bar as shown in the figure. Secure the transducers on the spacer bar using the knurled screws .

FIGURE 36: Using spacer bar – bar index holes numbering, Example number of holes = 4

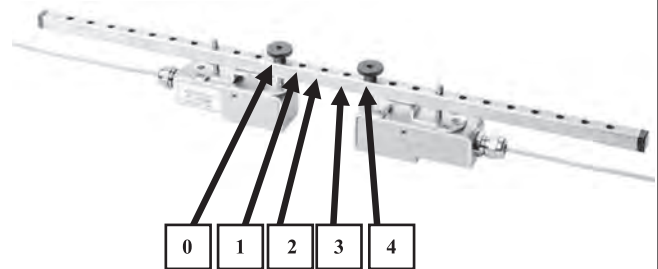

APPLIES TO FIXED UFM

Fix Transducers on Pipe Using Mounting Belts

The transducers are mounted by using the metal tension belts. The length of the belts are related to the maximum pipe size of the corresponding transducer (for example, when using -F10 (1 1/4" to 16") size of belt is suited for max. 16"). If using the same transducer for smaller pipes, shorten the belts. The belts are fastened by a tightener (Figure 37) which can be tightened by using a screwdriver (Figure 38).

FIGURE 37: Tightener for Metal Tension Belts

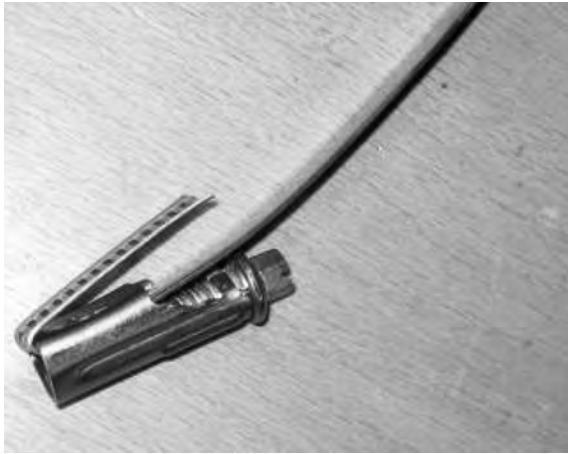
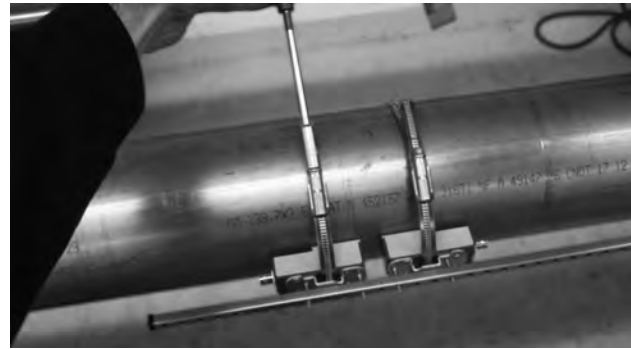
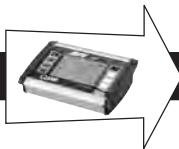

FIGURE 38: Tighten metal belts with screwdriver



Z-mode Mounting of Ultrasonic



APPLIES TO PORTABLE UFM

FIGURE 39: V-mode or W-mode without spacer bar



FIGURE 40: V-mode or W-mode with spacer bar



FIGURE 41: V-Mode Mount with Fabric-Reinforced Tensioning Tapes for Large Pipe Diameters



Z-Mode Installation

FIGURE 42: Z-mode mounting of ultrasonic transducers

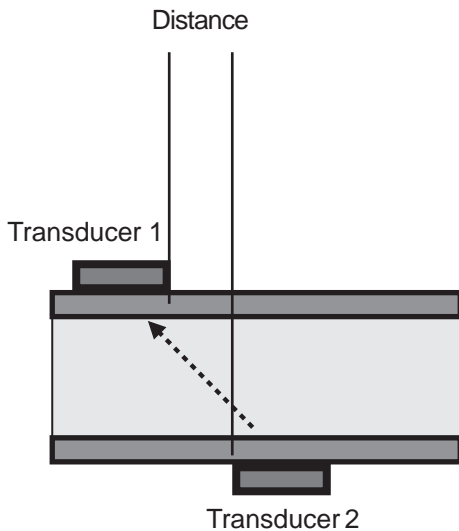

FIGURE 43: Z-mode mounting of ultrasonic transducers using mounting chains

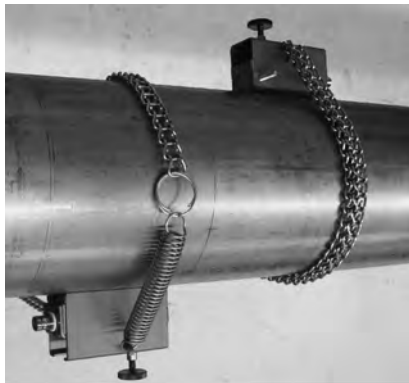

FIGURE 44: Z-mode installation with fabric-reinforced tensioning tapes for large pipe diameters



ULTRASONIC TRANSDUCER MOUNTING

Basic structure of the ultrasonic transducer:

The ultrasonic transducer (F10 and F21) is made of plastic (PEEK) that has a beige color and is protected by means of a metal sheath. The transducer is secured by means of a knurled screw that is passed through the transducer support. This support can be shifted in axial direction (arrow) with the help of the knurled screw (A).

The ultrasonic transducer type F05 consists only of the sensor sheath and the actual ultrasonic transducer.

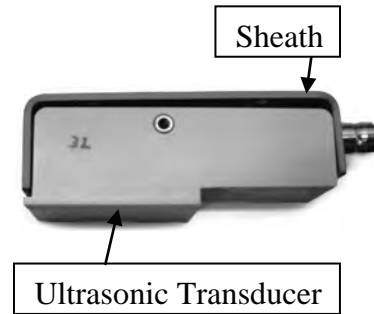

Layout of ultrasonic transducer

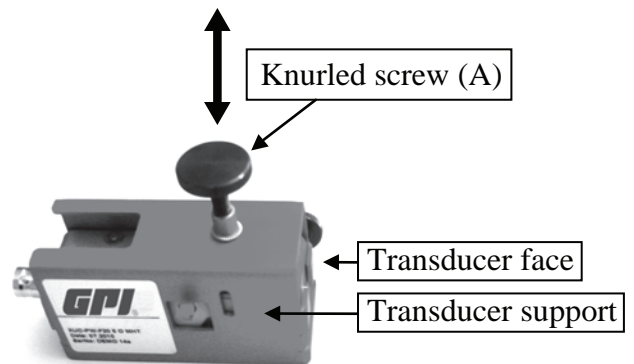

Before mounting the ultrasonic transducer onto the piping, the beige transducer surface must be brought into the position underneath the bottom edge of the transducer support (screw transducer into support).



Apply acoustic gel on the sensing face of the ultrasonic transducer.

Mounting in V-mode or W-mode

After setting up the parameters of the measuring point, the flow transmitter displays the distance between the transducers in inches (Figure 45) and as number of grid holes for use of the spacer bar (ultrasonic transducers type F10 and F21). Bar index number 5, for example, is equivalent to the number of grid holes between the ultrasonic transducers, plus the position at which the knurled screw of the opposing transducer has to be mounted. Install the transducers on the spacer bar as shown in the figure. Secure the transducers on the spacer bar using the knurled screws (B).

FIGURE 45: Positioning the ultrasonic transducers by means of spacer bar index

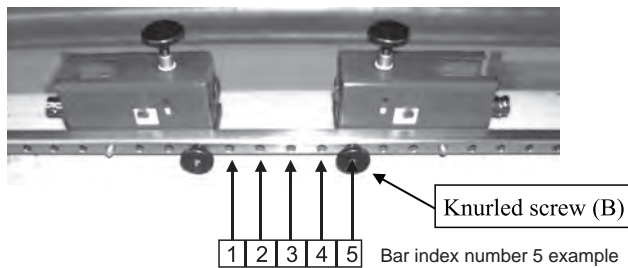

Fix Transducers on Pipe Using Mounting Chains

FIGURE 46: Secure the ultrasonic transducers (types F10 and F21) by means of stainless steel tensioning chain.

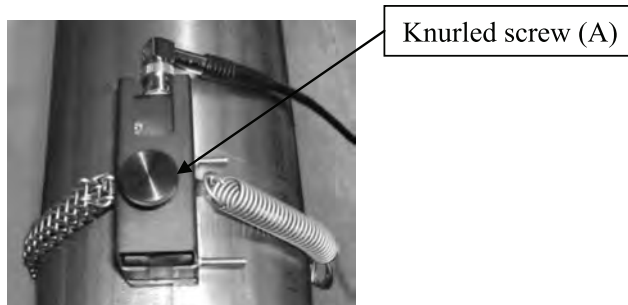

Fix the ultrasonic transducers using the stainless steel chains (with or without spacer bar).

Attach the chains to the hooks on the transducers while keeping them under slight tension. Attach the ultrasonic transducers to the pipe by adjusting the knurled screw (A) until the transducer is pressed slightly onto the pipe.

Transducers

The mounting of transducers in Z-Mode might be useful for bigger pipes and/or applications with low signals strengths (high particle/gas load). When using Z-mode, the spacer bar cannot be used since the two transducers are located on the opposite sides of the pipe. The distance between the transducers (“mounting distance”) depends on application (mainly pipe size). In Figure 47 the principle is illustrated. The following sections show how to place the transducers correctly.

FIGURE 47: Transducers mounted in Z-Mode

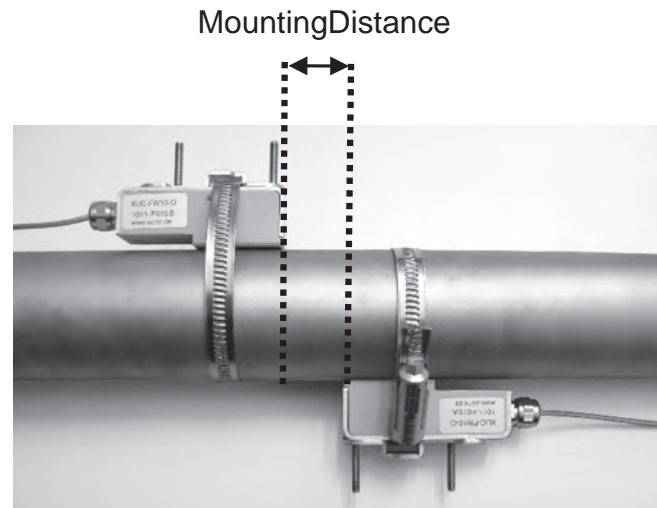

Use a plastic or paper template (not supplied) to mark the mounting positions. The example shows how to mark the positions using a plastic template.

1. Wrap the plastic template once around the pipe at the mounting position of the first ultrasonic transducer (transducers face has to be in line with the line to be drawn).
2. Using a felt tip pen, draw a line on the pipe along the template (corresponds with the pipe circumference)

FIGURES 48 AND 49: Attaching Plastic Template

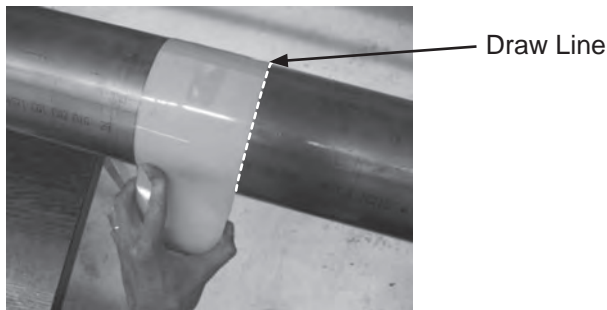
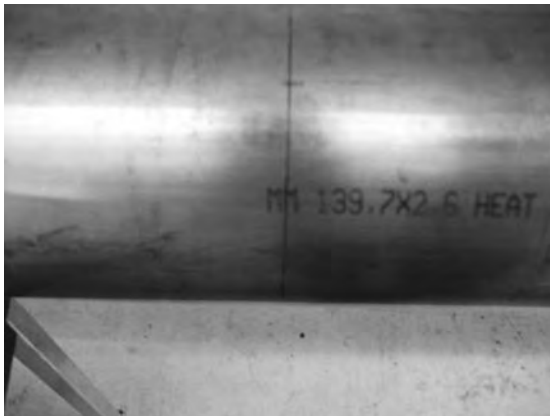

FIGURE 50: Pipe with First Mounting Line for First Transducer



3. After setting up parameters, the UFM displays the axial distance between the ultrasonic transducers (transducer distance) is displayed. Measure the transducer distance based on the value displayed on the UFM, starting from the first line drawn to the position at which the second line is to be drawn (mounting position for face of the second transducer).

FIGURE 51: Measure Required Distance (Given by Flow Transmitter)

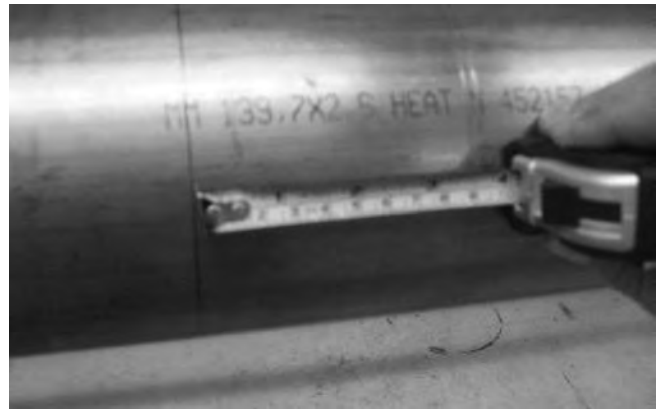
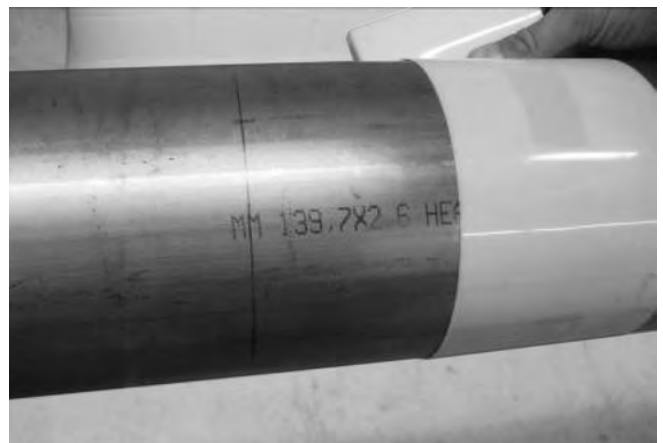
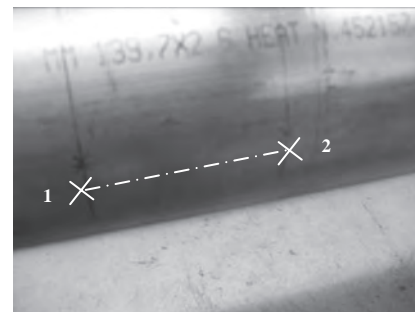

FIGURE 52: Set Up the Template to Mark the Mounting Position of the Second Transducer



4. Draw two cross hairs on the same axis, centered on the lines drawn with the help of the template.

FIGURE 53: Auxiliary marks



5. Mount the first transducer. Its face is positioned on the axis of the first line drawn. The **transducer face** (not the transducer) is centered onto the first cross hair. Now calculate half of the pipe's outer circumference.

$$U_{1/2} = \frac{2 \cdot \pi \cdot r}{2}$$



r = Radius of pipe including wall thickness
("outer radius")

Example: Radius (outer) = 250mm -> U =
2*3.1415*250mm/2 = 785.4mm

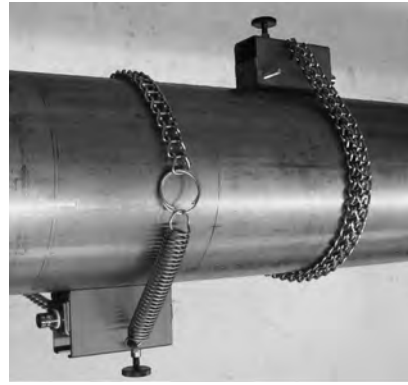

- Position the zero line of the measuring tape onto the center of the second cross hair drawn on the pipe (at same level as first transducer). Measure the previously calculated distance (half circumference). You should now have located the precise position opposite to the first transducer. Draw a third line at this position.

FIGURE 54: Determining the Mounting Position for Transducer

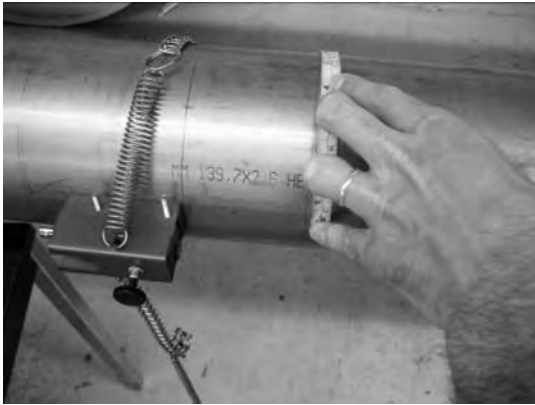

- Mount the second transducer. Its face is positioned on the axis of the second line drawn. The **transducer face** is centered onto the third cross hair. The transducers are now mounted precisely opposite to each other and are prepared for measuring in Z-mode.

FIGURE 55: Right Mounting of Transducers in Z-mode

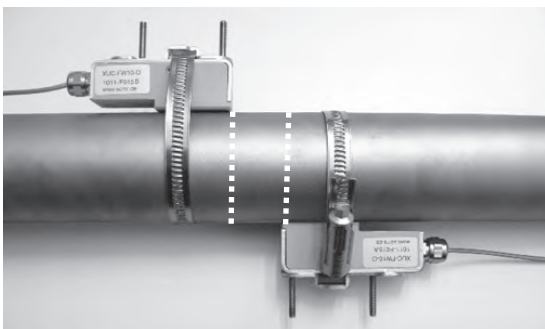

EDIT PARAMETERS

Edit system parameters using the complete setup menu. However, this method is less convenient, as it does not offer a step-by-step guide to setting up the parameters. It is therefore recommended to use the main menu only in situations that require editing of an individual parameter.

Editing the parameters includes access to piping, fluid and dialogs for selecting the ultrasonic transducer and mounting mode.

If you only want to change the mounting mode from V to Z, simply select "Transducer parameters" and change it without having to run a complete "Quick Setup" session.

This document provides only a brief overview of how to setup the parameters and main menu in the form of structure diagrams that help identify the functions grouped in the respective menu.

Navigate to the main menu:

In the primary measuring window "Flow 1": Select "Setup" -> "CMPL. SETUP"

Select the parameters to edit, for example, "Pipe Setup," "Fluid Setup," or "Transducer Setup."

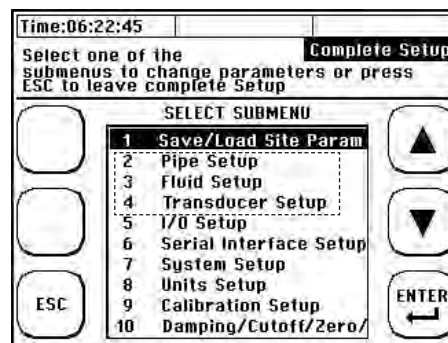

Direct access to the pipe parameters:

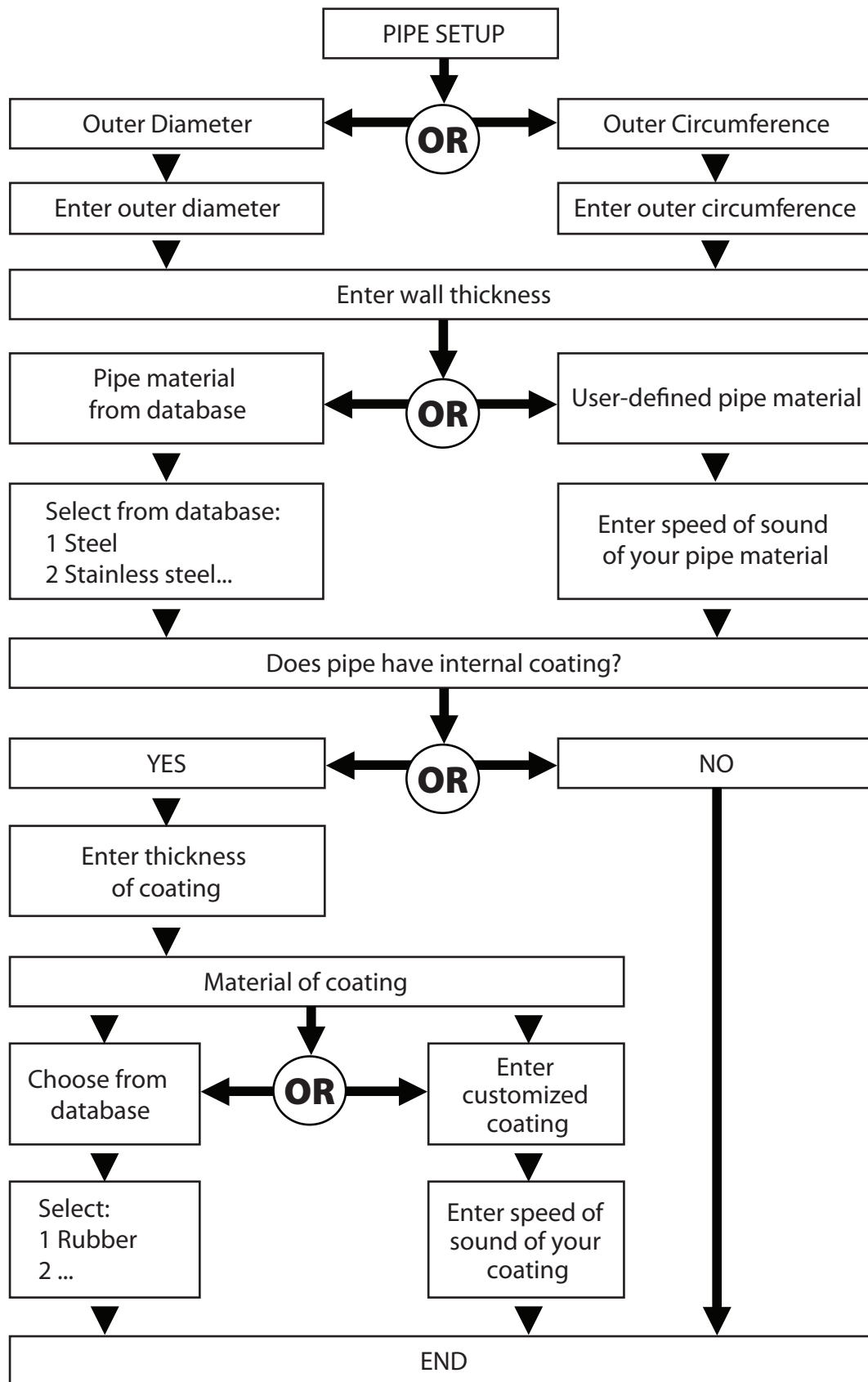

Setup Fluid Data

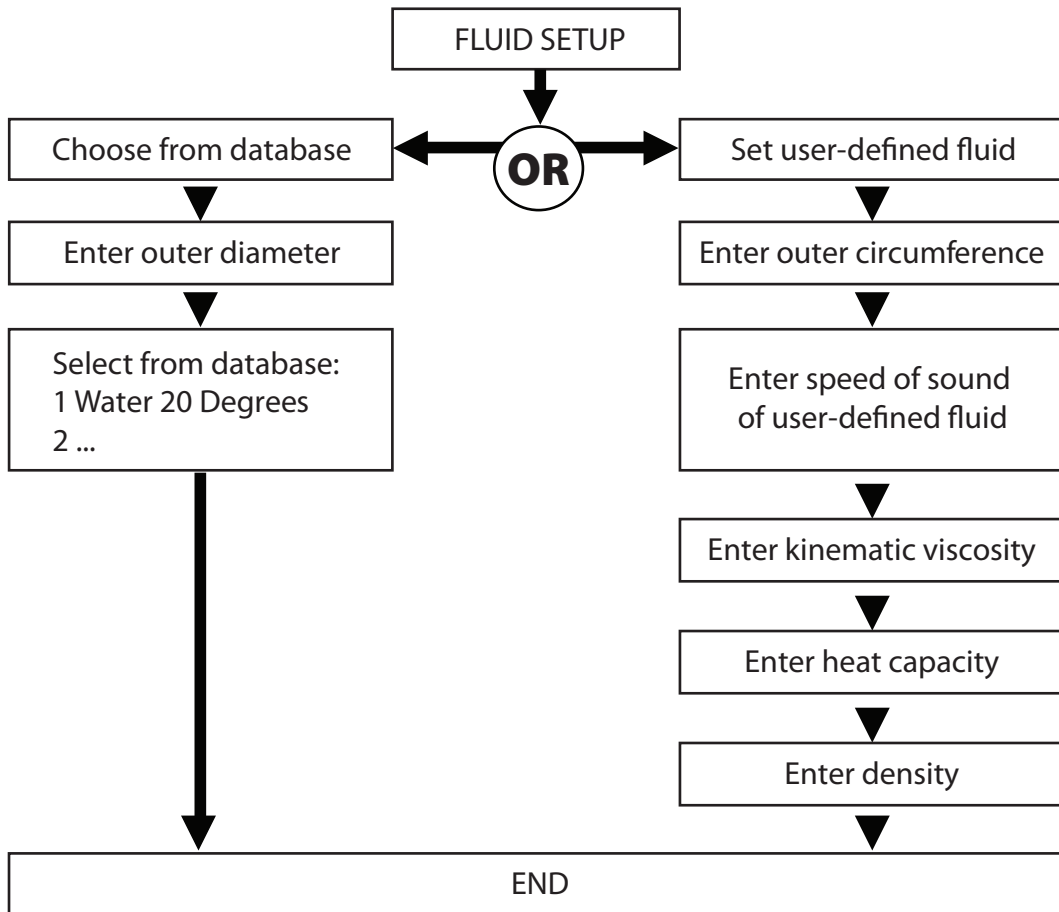

Direct access to selection of ultrasonic transducer and mounting mode:

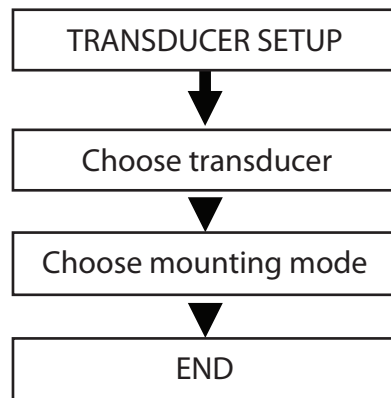

ZERO SETTING

It is advisable to run a zero calibration before starting measurements, if possible.

⚠ CAUTION
<p>Prerequisite for error-free zero calibration is the complete setup of the device, proper installation of both ultrasonic transducers on the pipe, and their electrical interconnection with the flow transmitter. Zero-flow is required for error free calibration. Wait two minutes after stopping process/shut-off pipe to allow the flow to calm down.</p>

Zero Calibration Starting in “Flow 1” Menu

1. Close the valves of the piping.
2. Navigate to the “Setup” window as follows, using one of three options:
3. After power-on: Select “Setup” within the start sequence
4. In the primary measuring window “Flow 1”: Select “Setup” and “Zero Setup”
5. Select “Set Zero”



The following window opens on completion of zero calibration:

Time:06:22:45		Diagnosis	
Flow	0.0 gal/h	T1	0.0°F
Power	0.0 MW	T2	0.0°F
Theta	0.0°		
Path Length	0.0 mm		
Delay	0.0 μs		
XDCR dist.	0.0 mm		
BAR index	0		
Gain	0		
dT Corr	0.0 ns		
SNR Indices	0		
Max Ampl. 1	0		
MEAS. Max Ampl. 2	111		
Quality	0		

The UFM displays the calculated correction value for the signal transit-time on completion of zero calibration.

Zero Calibration Using the Main Menu:

In the main menu, select “damping/cutOff/Zero” -> “Zero calibration”

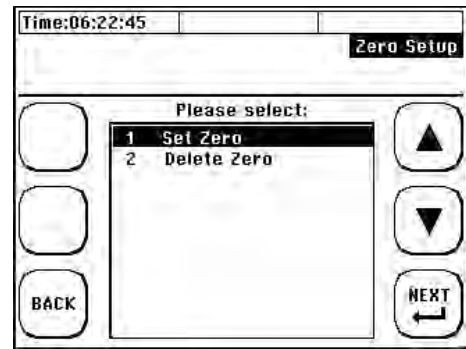

- Stop flow of fluid (close a valve)
- Choose Set Zero

Deleting the zero value

In the main menu, select “Zero Setup” - “Zero” - “Delete zero”. This action deletes the zero calibration and resets the meter to factory settings.

⚠ CAUTION
<p>Once the zero offset has been set, it will remain in the system until it is deleted or a new zero offset has been set. We recommend to make new zero setting at each new measurement when possible.</p>

i In the course of zero calibration with closed pipe valves, the UFM calculates the transit-time differential that may develop between the transducers and any residual flow. This calculated time (including zero) is automatically included for subsequent calculations during flow measurement. This method enhances the precision of the flow measurements. If it is not possible to close the pipe valves, delete the zero value that may have been set previously. If anything prevents performing a zero calibration, take the corresponding imperfection into account in your measurements. The zero setpoint is retained in device memory until it is overwritten with a new zero setpoint. If it was possible to close the pipe valves, check the “Flow” column in one of the three measuring windows to determine whether or not the flowrate is going down. Do not perform a zero calibration until a settled value is output to the flow display. A stop valve is not available at all positions of the piping. The tolerances that develop during installation, including tolerances of the ultrasonic transducers and pipe data, will lead to a certain zero offset error in the measuring equipment. Provided care was taken during installation, the flow velocity error should stay within the range from 0.00 ft./s to 0.09 ft./s. The zero offset error is reduced in proportion with increasing pipe size.

HEAT MEASUREMENT

The integrated heat measurement function enables you to determine the heat and cooling flow in your application using QMF-PT100 or QMP-PT100 temperature sensors.

Introduction

The temperature sensor no.1 is installed in the warmer section, while temperature sensor no. 2 is installed in the cooler section of the circuit (The QMF-PT100 are numbered on the cable). You can position the ultrasonic transducers at the warmer or cooler section. GPI recommends installing the transducers in the cooler section, as it is unlikely that they will be operated beyond their permissible temperature limit in these sections.

QStar UFM displays the thermal output and the accumulated heat quantity.

FIGURE 56: Block Diagram of Heat Measurement

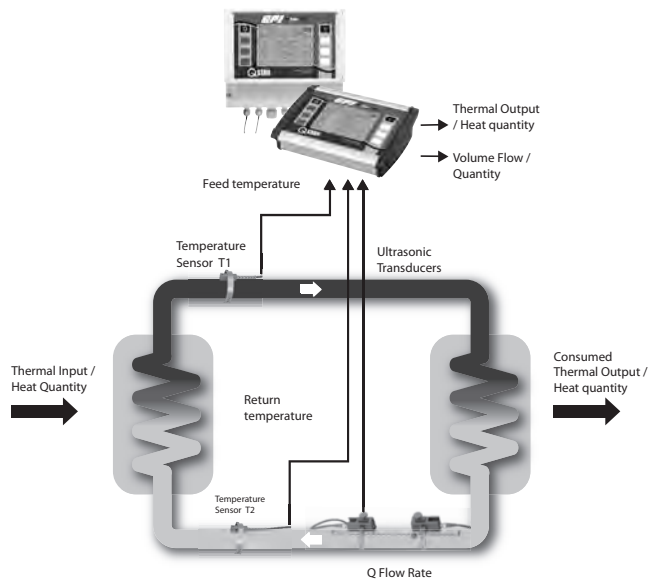

QStar UFM shows heat (kWh) and thermal output (kW)

Calculating Thermal Output

The cross-sectional area of the pipe's inner diameter [A] is multiplied by the flow velocity [v] and specific thermal capacity of the medium [c], as well as the differential temperature of both sensors, [T_hot - T_cold]. The product defines thermal output [Q] in W units.

$$Q = A \cdot v \cdot c_w \cdot (T_{hot} - T_{cold}) \quad Q = [W, kW]$$

Calculating heat (quantity)

The heat quantity is derived as a function of thermal output over time.

$$Q = \int \dot{Q} dt \quad Q = [J, kW / h]$$

INSTALLING THE TEMPERATURE SENSOR

Temperature sensors can be mounted on piping using a metal belt (photo) or fabric-reinforced tape. Install the temperature sensor on the pipe as follows.

FIGURE 57: Mounted Temperature Sensor



The measuring method used is a relative measurement. This means that the measured temperature values with absolute reference may deviate from this measuring equipment (for example, compared to submersion thermometers). It is important to set up a relation between both sensors. The ideal differential temperature between the temperature sensors should amount to zero degrees prior to installation on the piping.

Zero Setup of Temperature Sensors

From main menu "Flow 1": Press button **SETUP** -> **COMPL SETUP** -> **CALIBRATION SETUP** -> Select "QMF-PT100 T2-T1"

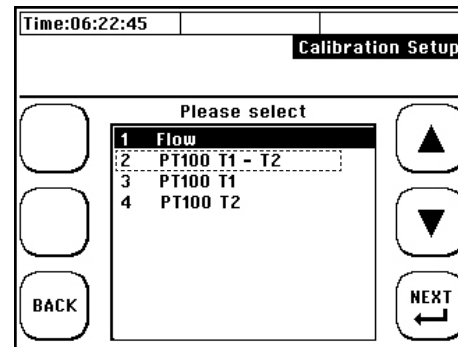

The differential temperature between both temperature sensors should amount to approximately zero degrees prior to installation of the transducers on the piping. Avoid touching the transducers in the preliminary phases. To equal both temperature sensors put them in a glass of water for a couple of minutes. To check the temperature of both sensors, use the values displayed in the "Heat quantity" measuring window that is described in the following section.

Select "READ OFFSET". QStar UFM automatically calculates the T2 to T1 offset. On completion of this calculation, the differential temperature T1 to T2 should amount to approximately zero degrees. Use the "Reset Offset" command to reset the calculated differential temperature to zero.

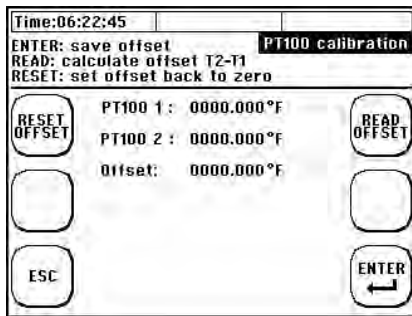

Absolute thermal output measurements (absolute measurement)

The device supports the alignment of the displayed temperature with a reference thermometer for each temperature sensor used. This functionality can be useful, for example, for heat measurements.



Example: The resistance thermometer installed in the pipe displays 348° F. However, the temperature sensors of your QStar UFM displays only 343° F. QStar UFM also supports manual adjustment of the offset. In this case, specify a setpoint of 348° F. The setpoint is an absolute value and not an offset.

Proceed as follows:

In the primary measuring window "Flow 1": Select "SETUP" -> "CMPL SETUP" -> CALIBRATION SETUP -> "PT100 T1"

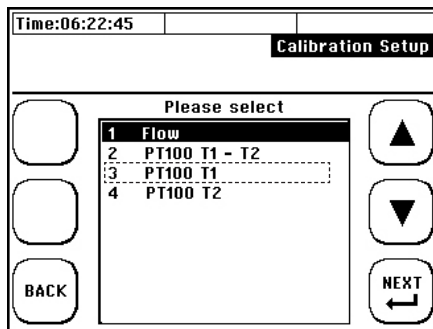

Enter the absolute setpoint for T1. Caution: The setpoint is an absolute value and not an offset in terms of the temperature displayed. You can select "RESET" to delete the setpoint for the PT100 T1. In this case the temperature sensor will indicate the actual temperature.

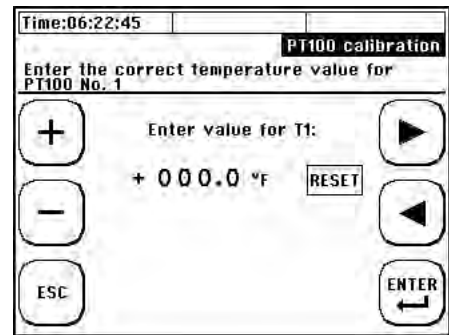

Same procedure is applicable for second temperature sensor. In this case please choose PT100 T2 in calibration menu.

MEASURING WINDOWS

THE MAIN DISPLAY "FLOW 1"

The "Flow 1" menu is the main menu that shows the current measured values like flow and thermal output.

Opening the central measuring window "Flow 1"

After power on: Wait approximately five seconds for the display of the start screen. The QStar UFM automatically opens the central measuring window "Flow 1".

Starting in the main menu: Select "ESC" > "MEAS."



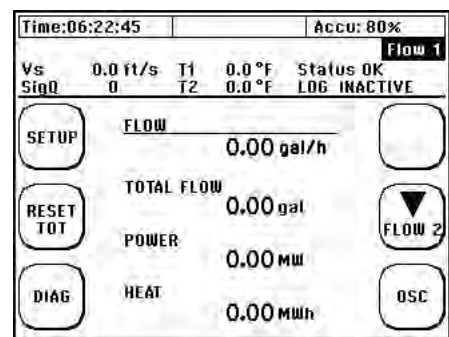

The "Flow 1" measuring window provides concise information that is important for flow and heat.



DATA IN MAIN MENU "FLOW 1"

PARAMETER	DESIGNATION
FLOW 0.00	Displays the current flowrate
TOTAL FLOW 0.00	Totalizer = flowrate counter. Displays the actual flowrate value.
POWER 0.00	Displays the actual thermal output
HEAT 0.00	Displays the actual heat quantity
Vs 0,0	Returns the sonic speed of the fluid

DATA IN MAIN MENU "FLOW 1"	
PARAMETER	DESIGNATION
SigQ 0	Specifies the signal quality in [%]
T1 0.0 °F T2 0.0 °F	Outputs the actual temperature of the connected QMF-PT100 temperature sensors. Signals the measurement status
Status OK	Indicates the status of the measurement
LOG INACTIVE	Indicates deactivated data logging
LOG ACTIVE	Indicates ongoing data logging
USB ON	Indicates USB-connection to PC

-  Resets the Totalizer (flowrate counter) to zero
-  Change to the diagnostics windows. Only necessary for information or if you do not receive any measurement results
-  Change to measuring window "Flow 2" providing further information
-  Change to oscilloscope menu to watch signals

MEASURING WINDOW "FLOW 2"



How to open the central measuring window "Flow 2."

Starting in the primary measuring window "Flow 1": Select "Flow 2."

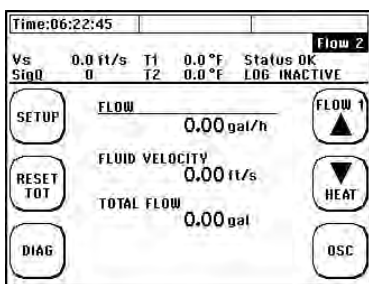
Flow measuring window 2 provides concise information that is important for flow measurements (without heat measurement). The window also provides additional flow velocity data.



ADDITIONAL CONTENT OF MENU "FLOW 2"	
FUNCTION	DESIGNATION
FLUID VELOCITY 0.00	Displays the actual flow velocity

-  Change to the primary measuring window "Flow 1".
-  Change to measuring window "Heat"

MEASURING WINDOW "HEAT"

Starting in the primary measuring window "Flow 1: Select 'Flow 2' -> Heat"

The "Heat" measuring window outputs concise information that is important for heat measurements.

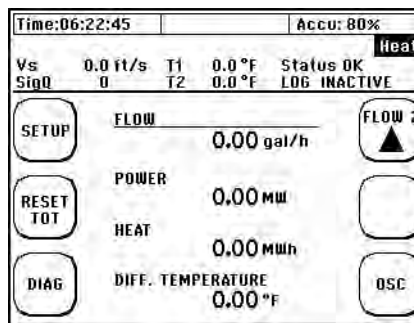

DATA IN MENU "HEAT"	
PARAMETER	DESIGNATION
POWER 0.00	Displays the actual thermal output.
HEAT 0.00	Displays the actual heat quantity.
DIFF. TEMPERATURE 0.00	Displays the differential temperature between the connected PT100 T1 and PT100 T2 temperature sensors.

-  Change to measuring window "Flow 2."

SELECTING THE PHYSICAL UNITS

How to access the "Units Setup" menu:

In the primary measuring window "Flow 1": Select "SETUP" -> "CMPL SETUP" -> Navigate to "Units Setup" in the main menu.

Select the variable to change the physical unit:

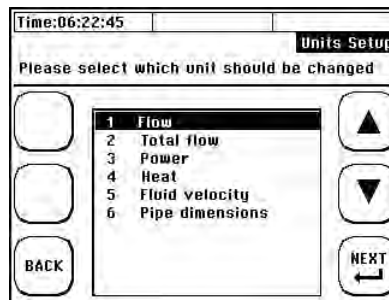

SELECTING THE FLOW UNIT

To access the physical unit from submenu “Flow 1”

In the primary measuring window “Flow 1”: Select “SETUP” -> “CMPL SETUP” -> Navigate to “Units Setup” in the main menu and then select “Flow.”

Select the parameter to change the unit:

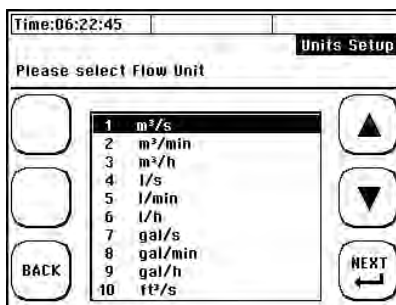
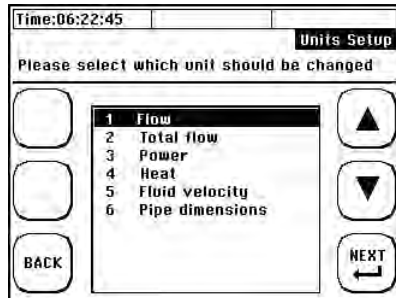

Now select the desired unit.

SELECTING THE PHYSICAL UNIT FOR THE TOTALIZER

To access the physical unit submenu “Totalizer”

In the primary measuring window “Flow 1”: Select “SETUP” -> “CMPL SETUP” -> Navigate to “Units Setup” in the main menu and then select “Total Flow”

Select the physical unit:

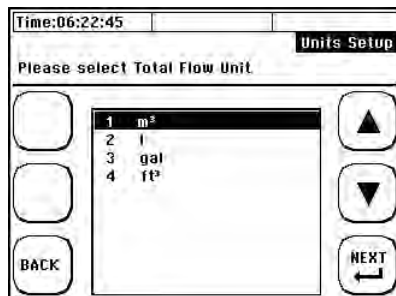

SELECTING THE PHYSICAL UNIT FOR THERMAL OUTPUT

To access the physical unit submenu “Thermal output”

In the primary measuring window “Flow 1”: Select “SETUP” -> “CMPL SETUP”. In the main menu, select “Units Setup” -> “Power.”

Select the physical unit:

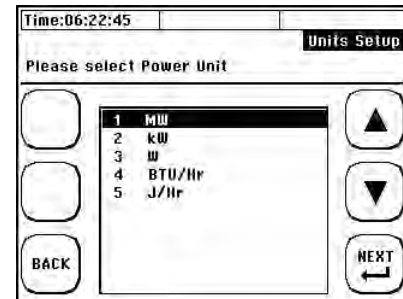

SELECTING THE PHYSICAL UNIT FOR HEAT QUANTITY

To access the physical unit submenu “Heat quantity”

In the primary measuring window “Flow 1”: Select “SETUP” -> “CMPL SETUP” — In the main menu, select “Units Setup” -> “Heat.”

Select the physical unit:

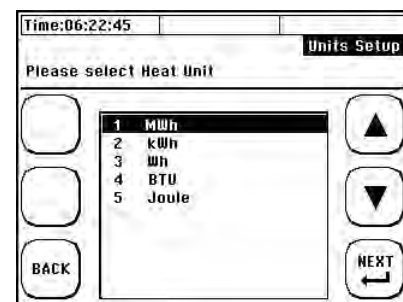

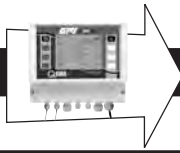

APPLIES TO FIXED QSTAR UFM

SETUP THE I/O

To access the I/O setup menu:

In the primary measuring window "Flow 1": Select "SETUP" -> "CMPL SETUP". In the "complete setup" menu, select "I/O Setup."

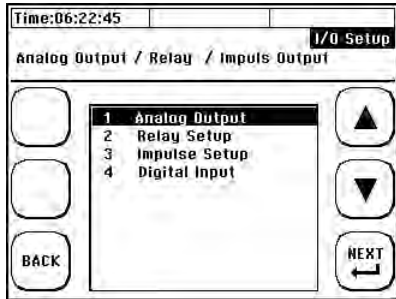

SETUP THE 4 mA TO 20 mA CURRENT OUTPUTS

CAUTION

Any connection of an active 4 mA to 20 mA analog output of QStar UFM with an external device that also provides a voltage at its inputs will cause fatal damage to your QStar UFM and external device. Before you interconnect both devices, always verify that your external recording (PCS) system is set to passive state.

The outputs of QStar UFM are working in active mode in factory state. That means that the flow transmitter provides the required voltage to run the outputs.

The inputs of the external device are connected directly to QStar UFM.

Outputs are activated (factory setting)

Active 1:

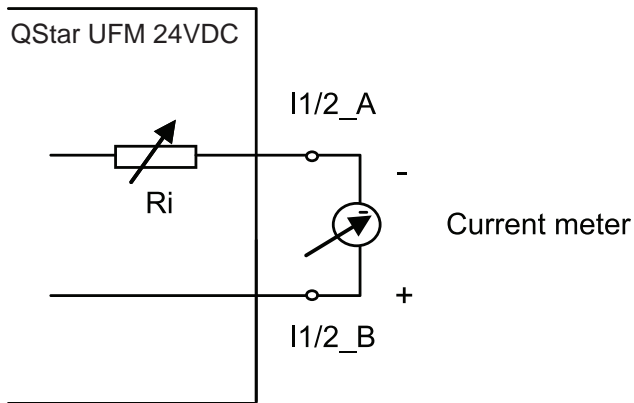

Output passive

Passive 1

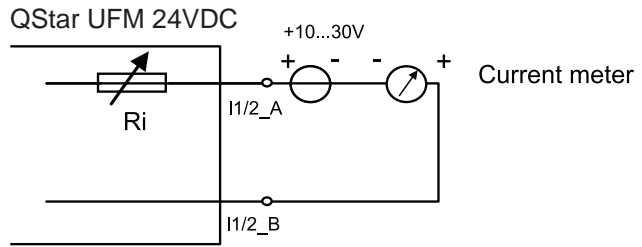

Passive 2

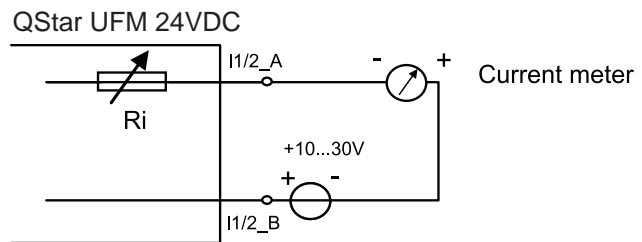

The mode (passive or active) of the outputs can be changed inside the QStar UFM. Always use the factory setting (active mode). If you need to change the mode, contact your GPI Customer Service Representative.

To access the "Analog output" menu:

In the primary measuring window "Flow 1": Select "SETUP" -> "CMPL SETUP". In the main menu, select -> "I/O Setup" -> Analog outputs".

Select the analog output to be used:

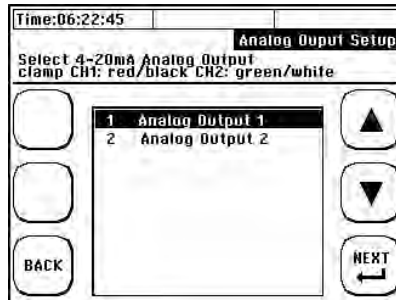

APPLIES TO FIXED QSTAR UFM (Continued)

Specify the variable to be output at the analog output:

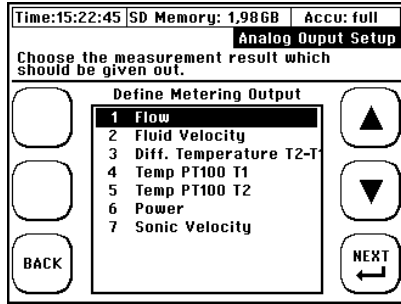

Select the value to be assigned to the 4 mA output (Example Flow).

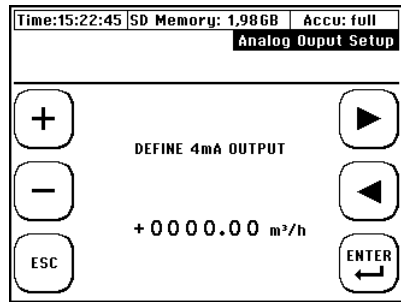

Select the value to be assigned to the 20mA output. The analog outputs only support unidirectional flow.

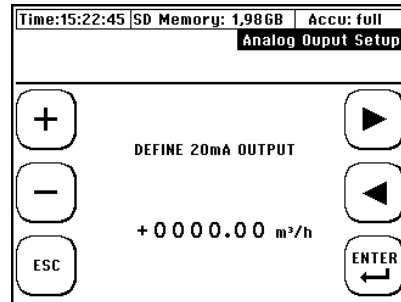

QStar UFM can only provide positive flows to the outputs. The flow display must return positive values. What happens if the value exceeds the setup high or low limits? Example: You expect a flowrate of 100m³/h and assigned this rate a value of 20 mA. However, the flowrate may reach 130 m³/h. This means that a value of 20 mA will also be output for flowrates higher than 100 m³/h.

SETUP RELAY PARAMETERS

QStar UFM is equipped with a relay output.

This output can be assigned a function or a range.

Example of an external circuitry:

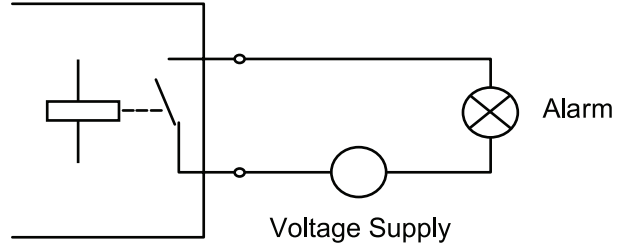

⚠ CAUTION

The relay has a NO (normally open) contact. The contact is only closed when triggered by a setup parameter function. The contact will retain its open state on power failure. You do not have to observe the polarity of the wiring since it is potential free.

To access the “Relay” menu:

In the primary measuring window “Flow 1”: Select “SETUP” -> “CMPL SETUP”. In the main menu, select -> “I/O Setup” -> “Relay”:

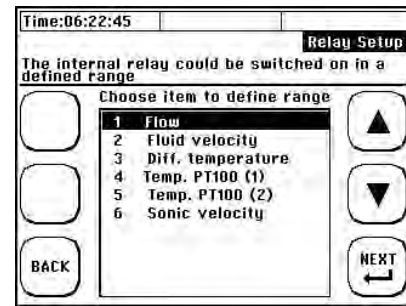

Choose value (lower limit) for activation of relay. Relay will be activated when measured value fall below the limit.

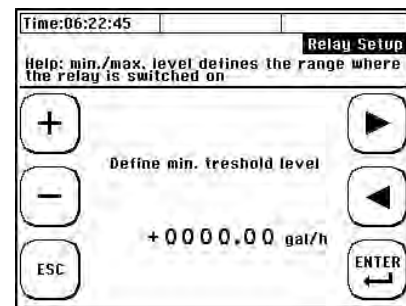



In addition to setup variables such as flow, QStar UFM applies the corresponding unit that is selected in the “Units Setup” setting and appended to the respective variable that is displayed in a measuring window. Example: If you selected the physical unit m³ for flow variables, the values of the switching points are also the parameters set in cubic meter.

Select the upper limit value for the relay. Relay will be activated when measured value exceeds the maximum limit.

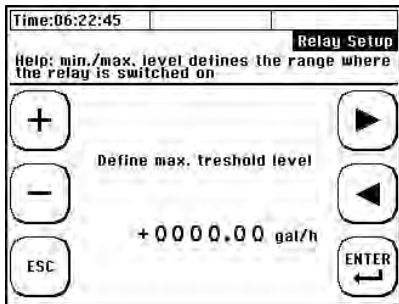

Example: A pump is operated in an application and the discharge volume of this pump is measured. The pump has a maximum discharge volume of 6000 m³/h and there is a risk of damage to the pump when the discharge volume drops to less than 150 m³/h. The objective is for QStar UFM to shut down the pump as soon as the value drops below a point at which damage to the pump can be expected. So in that case lower limit has to be set to 150m³/h, upper limit to 6000m³/h. Relay will be activated if flow falls below 150m³/h or exceeds 6000m³/h.

The physical unit cubic meter must have been assigned to the flow variables in the physical unit settings. The minimum activation point must have the parameters setup.

Setup the Digital Output (transistor)

QStar UFM provides one digital output (DO). The DO is a transistor output (open collector) and is typically used as a counter for volume (m³) or heat (kWh). The DO is operated in passive mode. That means a supply voltage (10...30VDC) has to be provided externally.

⚠ CAUTION

Be careful not to confuse the positive (+) and negative (-) voltage in order to avoid damage to the flow transmitter.

Connecting Digital Output

Example 1:

Connect the plus terminal of evaluation unit (for example, PCS) to the plus terminal of voltage supply. Connect the negative terminal of evaluation unit to the plus terminal of the DO. The negative terminal of the DO has to be connected to the negative terminal of external voltage supply.

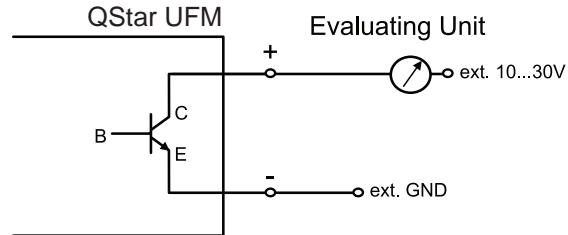

Example 2:

Connect a PNP transistor's emitter to the positive terminal of the external voltage supply. The basis of the transistor should be connected (via a resistance) to the positive terminal of the DO. The collector of the transistor should be connected to the positive terminal of evaluating unit (PCS). The negative terminal of the evaluating unit has to be connected to the negative terminals of the DO and the voltage supply.

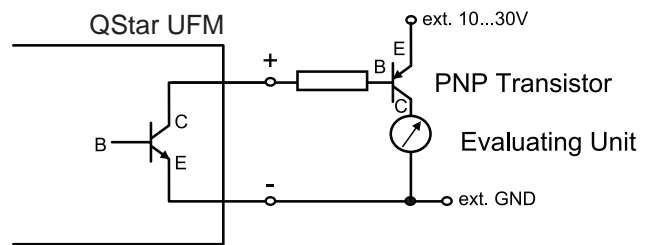

To enter the menu for Digital outputs:

Starting from main menu “Flow 1”: Choose SETUP -> COMPL SETUP -> I/O SETUP -> Digital Output.

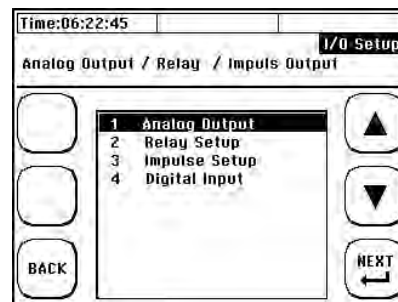

APPLIES TO FIXED QSTAR UFM (Continued)

Choose related data (heat or volume) to use with DO.

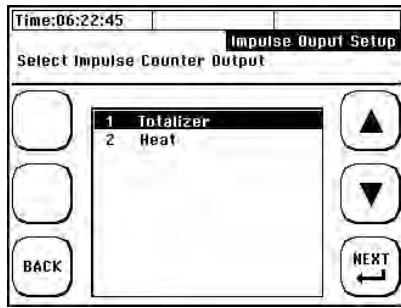

Choose the value (totalizer or heat) that represents one pulse.

Example: To get a pulse at the DO each 10m3 enter 10 here. Units can be changed in units setup.

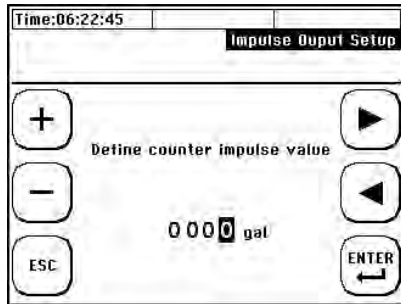

The unit in the digital output menu (for example, m3) is related to the chosen unit of the counter (totalizer). Example: Choosing unit l (litres) for the totalizer in the units setup menu also provides litres in the DO.

Choosing kWh as unit of the totalizer when using it for heat measurement also provides kWh in the DO.

SETUP THE SERIAL INTERFACE RS232

Using a separate RS232 interface board is an option. QStar UFM upgrades by simply plugging in the separate RS232 board. The RS232 sends ASCII strings including measurement data.

UPGRADE QSTAR UFM

Disconnect transmitter from power supply. Plug the RS232 board (QMF-RS232) into the two plugs in the region of the connection terminals (see *QStar UFM and Components: Interfaces of QStar UFM* to access the connection terminals).

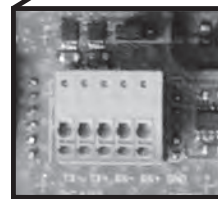
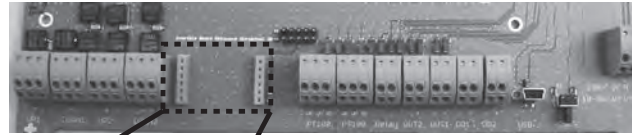

RS232 Board (QMF-RS232)

Now reconnect the power supply.

CONNECT RS232 BOARD TO A RECEIVER (PC OR PCS)

Requires a cable to be connected at the RS232 board and –typically– to a SubD (others possible due to customers demands).

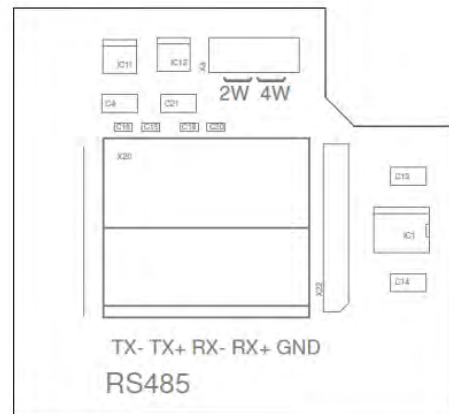

RS232 Interface board

TAG	Designation	Pin 9 Pol. Sub D
TX	Transmit Data	3
RX	Receive Data	2
GND	Ground	5



Pin assignment of standard Sub-D 9 pins

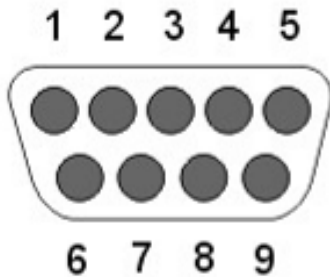

CONFIGURE RECEIVER (for example, PC) TO RECEIVE RS232 DATA

Choose interface where the RS232 is connected (for example, COM4).

Configure input according to Figure 58. Note: Bit rate cannot be changed (115200 bits/sec).

FIGURE 58: Configure Input for RS232 Communication

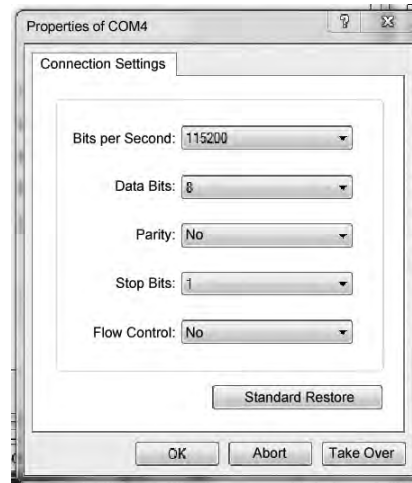

ACTIVATE THE RS232 INTERFACE

To activate the RS232 go to menu "Flow 1"

From main menu "Flow 1": Choose SETUP -> COMPL SETUP -> SERIAL INTERFACE (6)

To activate RS232 interface press YES

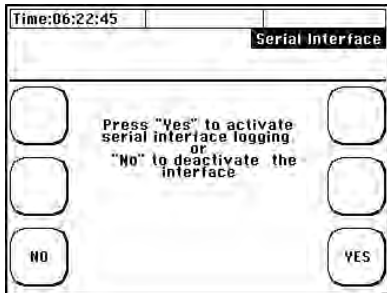

After successful configuration you should receive data as shown in Figure 59.

FIGURE 59: Receiving Data via RS232 Interface

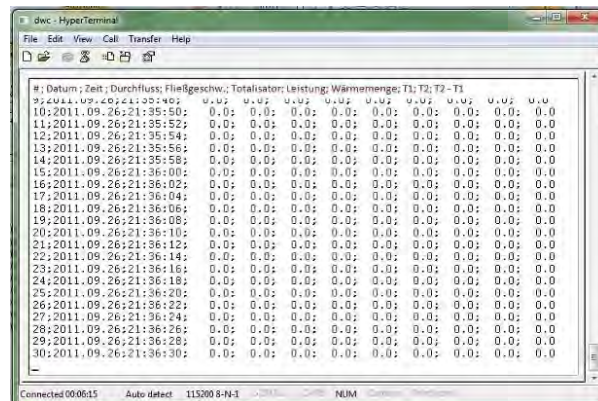

Then choose some parameters:

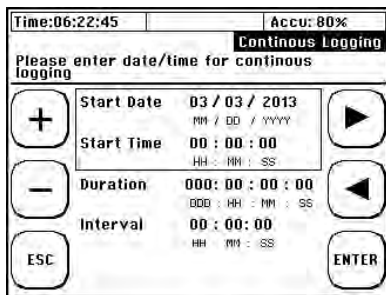

Start Date: Set date where RS232 communication should start.

Start Time: Set time where RS232 communication should start.

Duration: Set duration of RS232 communication.

Interval: Set interval (for example, 5 means that a data package is sent each five seconds).

i If you do not set a start time and date the communication starts immediately after setting duration and interval.

i To receive data use the Hyper Terminal provided by Windows. If serial interface is not available on the PC, use standard RS232 (Sub D-9) to USB converter.



APPLIES TO PORTABLE OSTAR UFM

SAVE, LOAD AND MANAGE DATA

Logging Data

The term data logging denotes the recording (saving) of measured value data on the internal SD Memory Card. All measurement data like time and date, flow, velocity, totalizer and thermal output, heat quantity and temperatures (when using temperature sensors). If temperature sensors should not be in use these values are shown as "0" in the log files. The data is stored in a text file (*.txt) which allows easy and quick export into office software like Microsoft® Excel or similar.

Time-Controlled Data Logging

Your UFM supports time controlled data logging to the internal SD memory card.

i The time controlled data logging uses the internal system time which is set by user. Make sure the system time is correct.

In the primary measuring window "Flow 1": Select "SETUP" -> "CMPL SETUP" -> "Data logger"

Navigate to the Data logger parameters field and confirm your entry with "NEXT". Assign a file name (min. 4 characters). Use the arrow keys to select the letters, or delete a letter by means of "DEL". Accept the letter with "ENTER". Select "DONE" and press "ENTER" to conclude data input

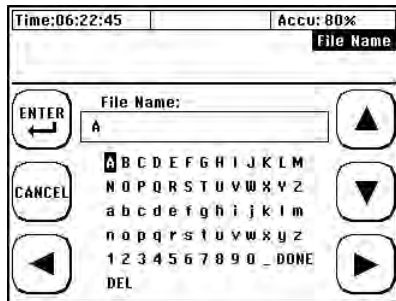

Continuous Data Logging:

Example: You want to log the data generated from May 25, 20YY, 3:00 PM to May 26, 20YY, 4:00 PM. The data is logged at cyclic intervals of 60 seconds to the SD Card.

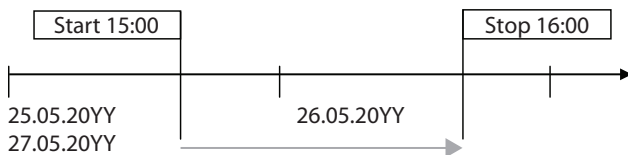

- Enter the start date May 25, 20YY
- Enter the start time 3:00 PM
- Enter the duration in 001:01:00:00 format
- Enter the interval in 00:00:60 format

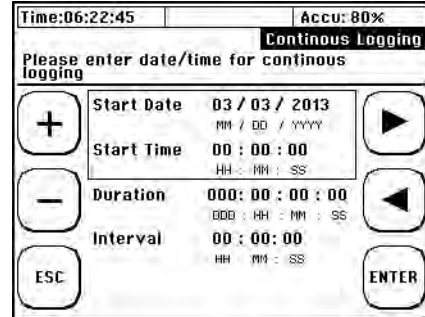

i The data logger does not average values over the cycling period. The current values are always stored. If you choose interval of 10 seconds the current values each 10 seconds are stored (not the average over last 10 sec).

To delete or to rename existing log files please connect your UFM to your PC using the USB cable. Then access the log files directly at the SD card.

Message "LOG ACTIVE" is being shown at the display while data logging is going on. If there is no data logging display shows "LOG INACTIVE."

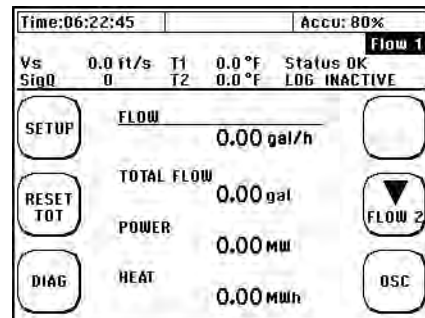

Cancel active data logging

If you want to quit an ongoing data logging before the defined stop time please go to main window "Flow": Choose "SETUP" -> COMPLSETUP -> DATALOGGER

The following window appears:

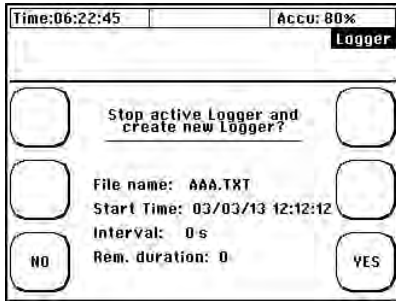

To cancel data logging press YES. The stored data will be still available on the SD card.

Save/load/edit parameters

The primary measuring window "Flow 1": Select "SETUP" -> "CMPL SETUP" -> "Save/load parameters".

Your UFM provides functions for saving and loading the parameter data. This saves time if you are taking measurements at different locations.

To save the parameters, use the arrow keys to select the memory space and confirm your entry with "NEXT":

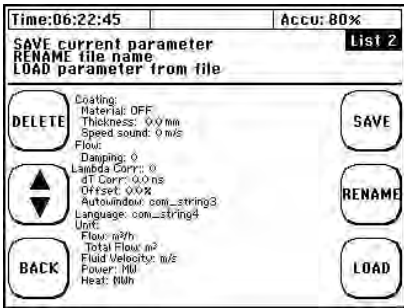

Your current data setup is displayed:

Enter a file name. Use the arrow keys to select the letters, or delete a letter by means of "DEL". Accept the letter with "ENTER". Select "DONE" and press "ENTER" to exit data input.

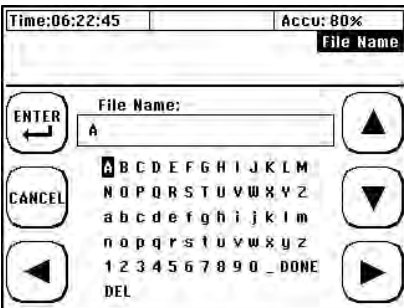

Select "SAVE" to save the parameter data.

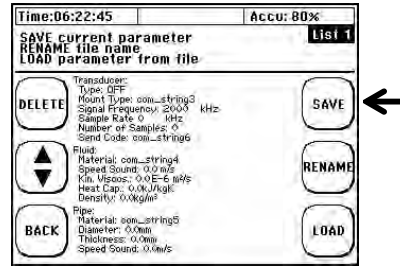

Select "LOAD" to load a parameter set from memory. Select "RENAME" to rename the stored file. Select Delete to delete the chosen parameter file.

Use the (up/down arrow) button to scroll through the details of the stored parameter file.

i The parameter files are stored into an internal data logger and not in the SD card. The SD card is reserved for data log files only. If you perform software reset stored parameter files will be deleted.

READING DATA ON THE COMPUTER

Connect via USB port to a computer using the USB cable supplied by GPI. Your UFM is automatically detected as mass storage medium (like a USB drive). Compatible operating systems include: XP, WIN2000, Vista, Windows 7, or MAC OS X.x. Your UFM is equipped with a USB 2.0 interface.

When successfully connected to a PC display will show message USB ON in the main menu "Flow 1".

FIGURE 60: Display when connected to a PC

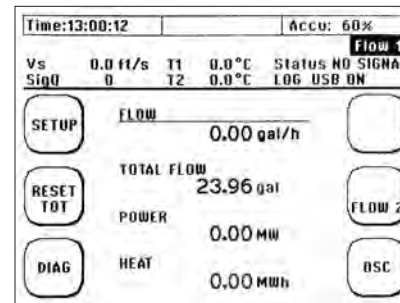

QStar's SD card will be detected from Windows/Linux and can be accessed in order to rename/delete or copy files.



Exporting data in Microsoft® Excel

Data logs are saved to a file with *.txt extension on the SD Card. The data can be imported directly to a standard data processing software such as Microsoft® Excel.

Copy the desired file to your PC. This guide shows basics of exporting the files into Microsoft® Excel. Of course working with the data logs is not restricted to Excel and is possible with comparable software.

i Free office software similar to Microsoft® Office can be found at www.openoffice.org.

The log file will look like this: Each line represents the data from one measuring point. The different values are separated by semicolon.

FIGURE 61: Log file opened by text editor

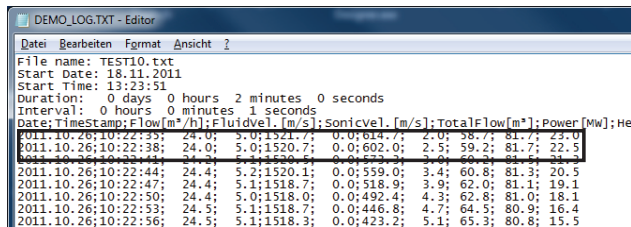
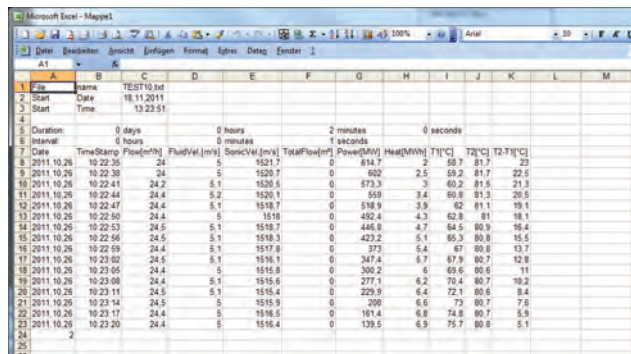

FIGURE 62: Data imported into Microsoft® Excel



SETTING THE PARAMETERS

How to access the I/O setup menu

In the primary measuring window “Flow 1”: Select “SETUP” -> “CMPL SETUP.” In the “complete setup” menu, select “I/O Setup.”

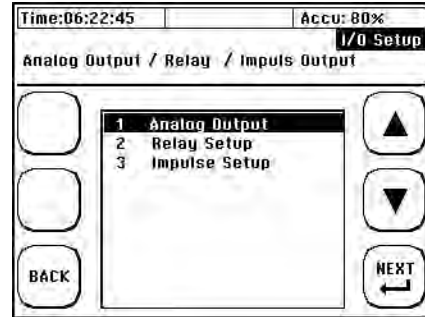

SETUP THE 4 mA TO 20 mA CURRENT OUTPUTS

QStar UFM provides two 4 mA to 20 mA current outputs. These outputs can be assigned different measured values. The outputs are set actively by default. This means that your QStar UFM always provides a voltage at these outputs.

CAUTION

Any connection of an active 4 mA to 20 mA analog output of QStar UFM with an external device that also provides a voltage at its inputs will cause fatal damage to your QStar UFM and external device. Before you interconnect both devices, always verify that your external recording (PCS) system is set to passive state.

The outputs of your UFM are working in active mode in factory state. That means that the flow transmitter provides the required voltage to run the outputs.

The inputs of the external device are connected directly to your UFM.

Outputs are activated (factory setting).

Activ 1:

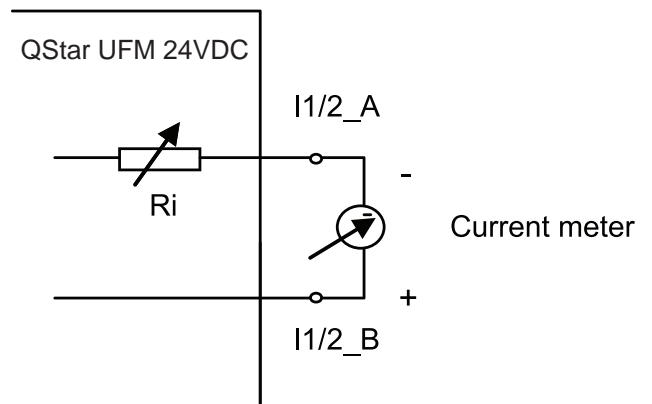

APPLIES TO PORTABLE QSTAR UFM (Continued)

Color coding of the 4mA to 20 mA output cable:

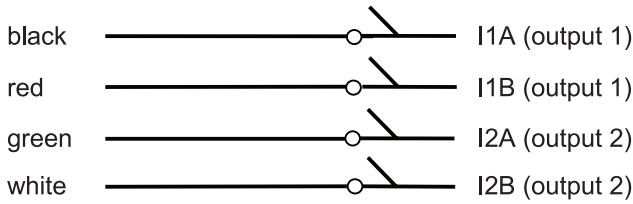

Current output 1 (I1A/B): Current flow is directed from I1B to I1A.

Current output 2 (I2A/B): Direction of the current flow is directed from I2B to I2A

How to access the “Analog output” menu:

In the primary measuring window “Flow 1”: Select “SETUP” -> “CMPL SETUP”. In the main menu, select -> “I/O Setup” -> Analog outputs.

Select the analog output to be used:

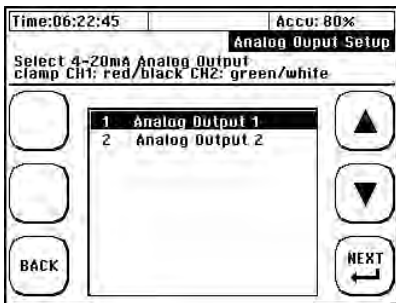

Specify the variable to be output at the analog output:

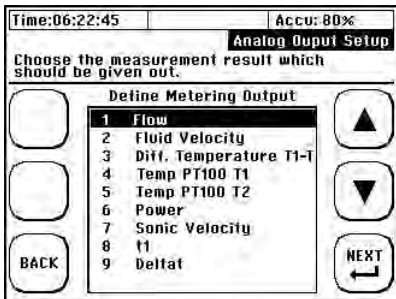

Select the value to be assigned to the 4mA output (Example Flow)



Select the value to be assigned to the 20mA output. The analog outputs at your UFM only support uni-directional flow.

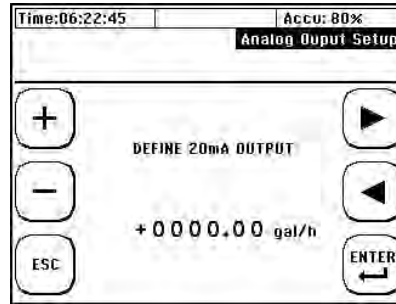

QStar UFM can only provide positive flows to the outputs. The flow display must return positive values. What happens if the value exceeds the setup high or low limits? Example: You expect a flowrate of 100m³/h and assigned this rate a value of 20 mA. However, the flowrate may reach 130 m³. This means that a value of 20mA will also be output for flowrates higher than 100 m³/s.



When do you have an error situation?

- If limits of the values previously assigned to the 4mA and 20mA outputs were exceeded on expiration of a specific time (burnout)
- Signal loss

Example: You expect a maximum flowrate of 100 m³ in your application and assigned this rate the 20mA value. You also set the following defaults for the error mode.

If an error is pending, the 4mA to 20mA output enters the error mode and outputs 4mA on expiration of a delay time of 20 seconds. In practical operation you may have a flowrate of 130 m³ in the piping for a duration up to two minutes. In this case, QStar UFM would output 20mA for the duration of 20 seconds and then enter the error mode and output 4mA on expiration of a timeout of 20 seconds. After the flowrate has dropped again to a value less than 100 m³ (on expiration of 100 seconds), the QStar UFM will automatically exit the error mode and output the setup current for the flow.

SETUP THE RELAY

Your QStar UFM is equipped with a relay output. This output can be assigned a function or a range. Example of an external circuitry:

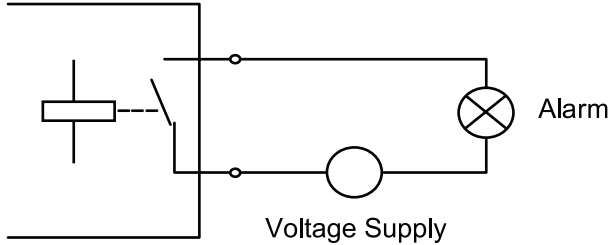

You link an alarm beacon with the output to signal that the flowrate has undershot the lower threshold limit.

Color coding of the relay output cable:

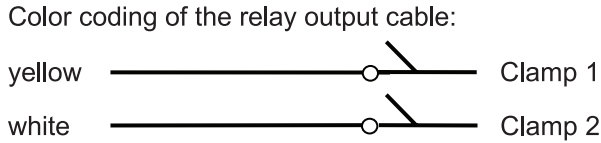

CAUTION

The relay has a NO (normally open) contact. The contact is only closed when triggered by a setup function. The contact will retain its open state on power failure and with low rechargeable battery. You do not have to observe the polarity of the wiring since it is potential free.

To access the "Analog output" menu:

In the primary measuring window "Flow 1": Select "SETUP" -> "CMPL SETUP". In the main menu, select -> "I/O Setup" -> "Relay":

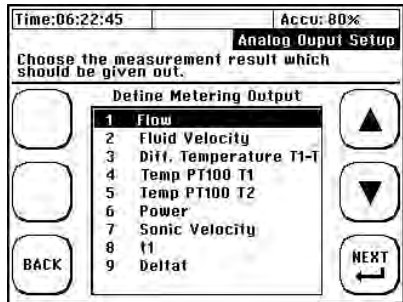

Choose value (lower limit) for activation of relay. Relay will be activated when measured value fall below the limit.

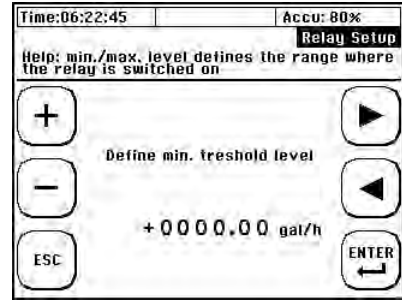

In addition to setup variables such as flow, QStar UFM applies the corresponding unit that is selected in the "Units Setup" setting and appended to the respective variable that is displayed in a measuring window. Example: If you selected the physical unit m³ for flow variables, the values of the switching points are also setup in cubic meter.

Select the upper limit value for the relay. Relay will be activated when measured value exceeds the maximum limit.

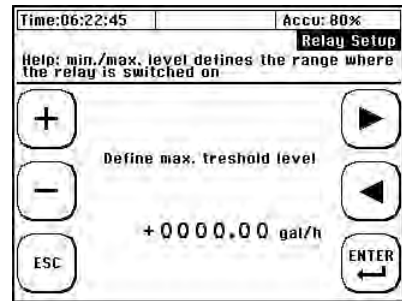

Example: A pump is operated in an application and the discharge volume of this pump is measured. The pump has a maximum discharge volume of 6000 m³ /h and there is a risk of damage to the pump when the discharge volume drops to less than 150 m³/h. The objective is for QStar UFM to shut down the pump as soon as the value drops below a point at which damage to the pump can be expected. So in that case, lower limit has to be set to 150m³/h, upper limit to 6000m³/h. Relay will be activated if flow falls below 150m³/h or exceeds 6000m³/h.

The physical unit cubic meter must have been assigned to the flow variables in the physical unit settings. The minimum activation point must have been setup.

CALIBRATION

QStar UFM provides a calibrating function that can be used to calibrate the flow. It may also be used to calibrate the analog outputs and temperature sensors.

To access the “Calibration” menu:

In the primary measuring window “Flow 1”: Select “SETUP” -> “CMPL SETUP” -> Navigate to “Calibration Setup” in the main menu”.

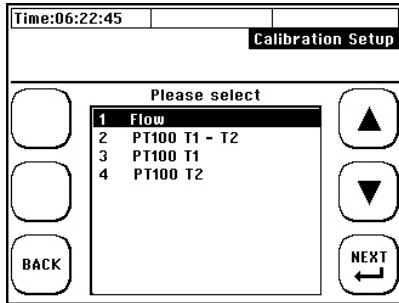

CALIBRATING FLOW

Select “Flow” from the calibration menu”.

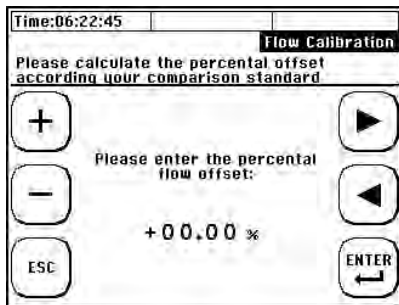

Enter an offset percentage that is relative to calibration reference.



To calibrate QStar UFM, we recommend you take measurements at different flow velocities then calculate the mean value of the results. GPI calculates the mean value based on five different flow velocities. The flow offset is retained in device memory until it is overwritten with a new value word.

CALIBRATING THE TEMPERATURE SENSOR

For more information on temperature sensor calibration, refer to the section *Measuring with QStar UFM: Heat measurement*.

SYSTEM SETTINGS

To access the “System settings” menu:

In the primary measuring window “Flow 1”: Select “SETUP” -> “CMPL SETUP” -> Navigate to “System Setup” in the main menu

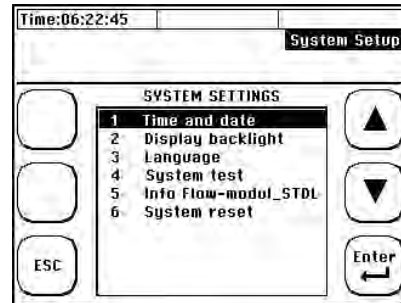

Editing the Time and Date

To access the “Time and date” menu:

In the primary measuring window “Flow 1”: Select “SETUP” -> “CMPL SETUP”. In the main menu, select “System Setup” -> “Time and date

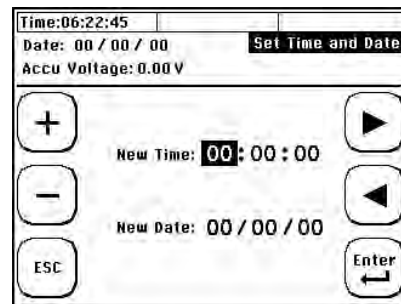

Enter the time with the format hh(hour):mm(minutes):ss (seconds). Enter the date with the format: mm(month).dd(day).yy(year).

Modifying the Display Backlight

To access the “Backlight” menu:

In the primary measuring window “Flow 1”: Select “SETUP” -> “CMPL SETUP” — In the main menu, select “System Setup” -> “Backlight”

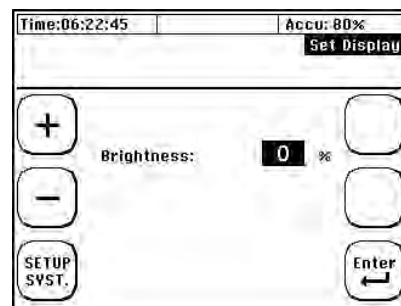

Adjust the display brightness by setting value (0% = no backlight, 100% maximum brightness).

Change Language

1. Switch on the UFM— Within the start sequence, press the multifunctional key next to the “SETUP” field.

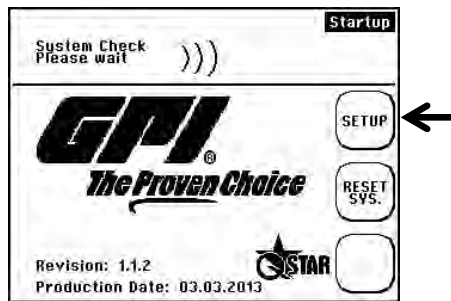

2. Confirm the “SETUP LANG.” button.

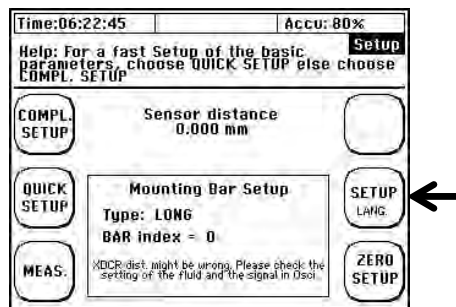

3. Use the arrows in the next window to select the dialog language. Confirm entry with “Enter” and exit the menu with “SETUP”.



⚠ CAUTION

The language setting changes the language used in the menus. The language in the fields next to the multifunctional button remain unchanged.

MISCELLANEOUS

To access the “Miscellaneous” menu:

In the primary measuring window “Flow 1”: Select “SETUP” -> “CMPL SETUP” — In the main menu, navigate to “Damping/CutOff/Zero” menu.

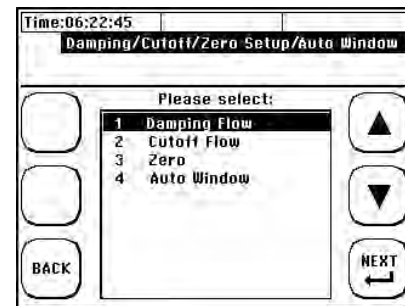

Flow Damping

In the primary measuring window “Flow 1”: Select “SETUP” -> “CMPL SETUP”. In the main menu, navigate to “Damping/CutOff/Zero” -> “Damping Flow”

Specify an attenuation of signal output in this dialog. Enter a damping time. It is a T63 damping. That means after damping time the displayed value has reached 63% of real change.

Example: Damping time 5 seconds, Flow change from 1 m³/h to 2 m³/h.

Display: Shows 1.63m³/h after 5 seconds, 2.00 m³/h after another 5 seconds (10 seconds in total).

Typical values are 5-30 seconds. The higher the damping the slower the measurement but the “smoother” the measurement curve.

Flow Cut off

In the primary measuring window “Flow 1”: Select “SETUP” -> “CMPL SETUP”. In the main menu, navigate to “System Setup” -> “Damping/Cut off/ Zero” -> “Cut off Flow”.

Only the flow velocities that are greater than the setup “Cut off” will be displayed. Lower velocities will be displayed as 0.

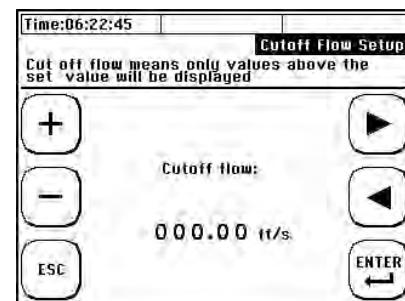

Zero Setting

In the primary measuring window “Flow 1”: Select “SETUP” -> “CMPL SETUP”. In the main menu, navigate to “System Setup” -> “Damping/CutOff/Zero” -> “Zero”.

System Setup-> “System information”

In the primary measuring window “Flow 1”: Select “SETUP” -> “CMPL SETUP” — In the main menu, navigate to “System Setup” -> “Info Flow Module”. Check version of software to see if an update is available.

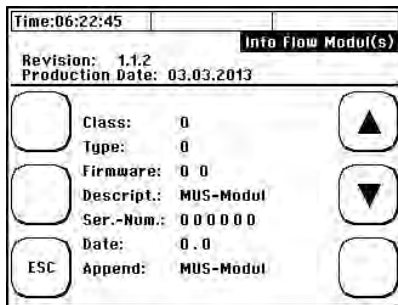

Software Reset

Use software reset in all other cases like getting an implausible measurement or reading on the display. Data stored on SD card will not be deleted. Data stored internally (parameter files) will be deleted.

There are different possibilities to make a software reset

- Immediately after switching on, press “RESET SYS” at the starting screen.



- From the main menu “Flow 1” choose SETUP -> COMPL SETUP -> SYSTEM -> RESET SYS.

RESETTING QSTAR UFM

Two different types of resets:

- Hardware Reset
- Software Reset

Hardware Reset

Hardware reset is only necessary when QStar UFM hangs up and cannot be operated any longer by using the buttons. Data stored internally or on the SD card will not be deleted.

Fixed QStar UFM: The hardware reset can be activated by pressing the reset button located behind the cover.

Portable QStar UFM: The hardware can be reset by putting a small screwdriver or a paper clip into the hole on the backside of the transmitter.

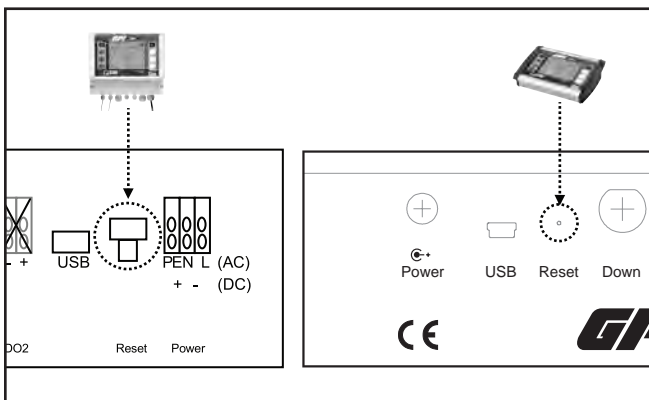

CAUTION

Reset the date and time after each software reset.

TROUBLESHOOTING

Use the following check lists for troubleshooting and check all items listed. If an error prevents you from taking proper measurements after you completed the check, contact GPI Customer Service Representative at: (888) 996-3837.

Make sure to have the following information available:

- Pipe material
- Pipe outer diameter
- Wall thickness
- Medium type and temperature
- Type/length of the intake/discharge circuits
- Type of transducer used



Use the “QStar UFM troubleshooting” information for troubleshooting by means of step-by-step elimination of items. This procedure helps when troubleshooting complex issues and in locating the fault systematically.

TROUBLESHOOTING	
A: NO MEASURE AT ALL	
1. Are you absolutely certain that the piping is completely filled?	<input type="checkbox"/>
2. Can you exclude gas load on the medium? Is a pump close by? If there is gas load: <ul style="list-style-type: none"> • Are the transducers installed at the 10 AM or 2 PM position on the horizontal pipe? • If there is gas load on the medium, is there an option of mounting the transducers to a vertical pipe? If yes, mount the transducers to a vertical pipe. 	<input type="checkbox"/>
3. What is the solid particle content of the fluid?	<input type="checkbox"/>
4. Are you absolutely certain of the wall thickness? Check the piping for the presence of engraved information that may be of relevance. Hot water piping is subject to the formation of lime deposits that may propagate the deposit of solid particles of fluid with high content. Use a wall thickness meter. You can purchase a wall thickness meter from GPI. Check the wall thickness entry on the device.	<input type="checkbox"/>
5. Did you enter the outer diameter of the pipe, or its circumference ? Check the corresponding values once again.	<input type="checkbox"/>
6. Have you selected the correct piping material? Are you certain the piping is not lined ? When taking measurements on a pipe made of concrete you must presume that this piping does not have sound conducting properties. Check the setup values once again.	<input type="checkbox"/>
7. Does the ultrasonic transducer match the application with regard to pipe dimensions and medium temperature? Is the temperature of the fluid within permitted limits? Did you select a suitable ultrasonic transducers for the application with regard to the pipe dimensions? Once again, verify that you selected the correct ultrasonic transducer and that it is setup.	<input type="checkbox"/>
8. Which transducer mounting mode did you select? Standard is the V-mode. If you selected the W-mode, you should first try the V-mode.	<input type="checkbox"/>
9. Verify the proper transducer distance. Take the measurements at the transducer faces. When using a spacer bar, check the number of holes between the transducer mounting positions.	<input type="checkbox"/>

TROUBLESHOOTING	
A: NO MEASURE AT ALL	
10. Does the piping have a thick paint coating? If yes, try to remove the paint at the position where you are planning to install the ultrasonic transducers using sand paper. Never take any measurements on piping insulation, no matter what type of material is involved.	<input type="checkbox"/>
11. Did you apply an appropriate film of acoustic coupling gel (MagnaLube) to the transducer faces? Small transducers (types QMP-F10 and F21) need approximately 1.2 inches, whereas the large transducer (QMP-F05) requires approximately 2.4 inches of coupling gel.	<input type="checkbox"/>
12. Do the transducers apply adequate pressure on the piping?	<input type="checkbox"/>
13. Are the transducers that are mounted without spacer bar precisely aligned along a common axis on the piping?	<input type="checkbox"/>
14. Are there sources of strong disturbance such as transformers, electrical drives, or sources of vibration in the immediate area of measurement?	<input type="checkbox"/>
15. Use the Z-mode for installation if all of your efforts did not yield a satisfactory result. Setup your device accordingly. You might also try to test your equipment on a different piping section that is close by in order to find out whether or not you can perform a measurement. Check all measuring leads for damage.	<input type="checkbox"/>

B: IMPRECISE MEASUREMENT RESULTS	
1. Did you observe the corresponding upstream and downstream distances? The quality of measurements will deteriorate in proportion to shorter upstream and downstream distances.	<input type="checkbox"/>
2. Did you perform a zero calibration after having closed a stop valve on piping?	<input type="checkbox"/>
3. Check the setup values with regard to the: <ul style="list-style-type: none"> • Pipe outer diameter • Wall thickness • Piping material • Transducer distance 	<input type="checkbox"/>

Measures to take if the piping is not filled completely.

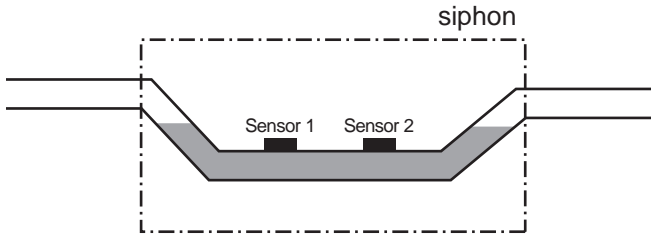

If you cannot separate the piping, because it is plastic piping, for example, or if the application is in the planning or installation phase, it is recommended to use a siphon to compensate for partially filled piping. The gradient of the siphon is calculated based on the expected flow velocity and contamination load. Contact GPI for support if it is necessary to install a siphon for your application.

DIAGNOSTIC MENU

Oscilloscope/Auto-Window

Signal propagation

QStar UFM offers sophisticated diagnostic menus allowing users to optimize challenging measurements in harsh conditions. To use the diagnostic menu for troubleshooting, a background in signal propagation is provided.

Figure 63 illustrates which signals occur and how they propagate at the pipe.

FIGURE 63: Signal propagation

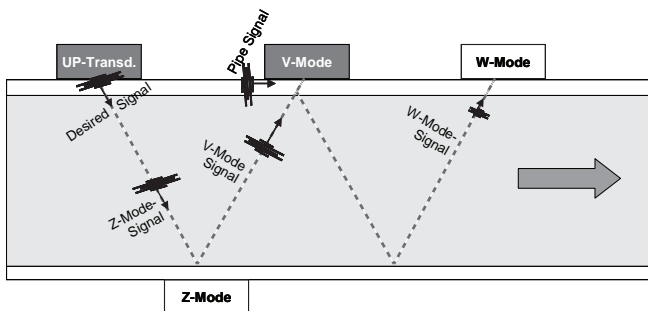

The UP-transducer mounted at upstream position emits the send (or desired) signal. This signal propagates within the pipe wall (“pipe signal”) as well as in the fluid. The signal propagating in the fluid is reflected a couple of times at the pipe walls (Z-Mode signal, V-mode signal, W-mode signal). The signal which represents the desired signal depends on mounting mode. For example, when mounted in V-mode the V-mode signal is the desired signal. The other signals (Z-mode, W-mode, pipe wall) may also disturb this signal. The corresponding transducer is mounted in V-mode as standard but Z-mode and W-modes are possible. This transducer receives the signals and returns another signal to UP transducer.

The time the signals needs from one transducer to the corresponding transducer (run time) depends on path length (distance), speed of sound of materials, fluid and flow velocity.

Depending on mounting mode the signals might look as shown in Figure 64.

FIGURE 64: Signal Images

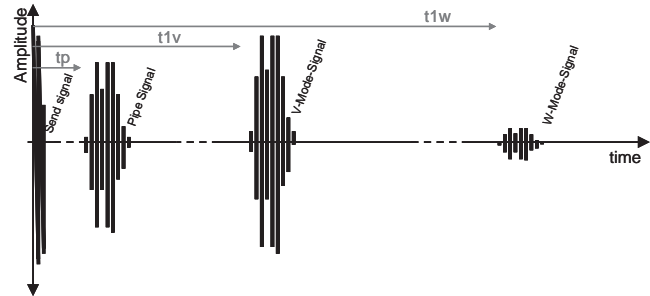

At $t=0$ the UP-transducer starts signal transmission. After time $T=tp$ you can see the pipe wall signal which reaches the corresponding transducer first because of shorter distance and (usually) faster propagation caused by higher speed of sound of pipe material.

After that, at time $T=t1v$, the V-mode signal reaches the transducer (single reflection at opposite pipe wall). After $t1w$ (approximately $2x t1p$) the W-mode signal is being detected. Usually, when having pipe materials highly conductible for ultrasonic signals (metals) and small pipes, the pipe wall signal has high amplitude which is similar to amplitude of V-mode signal. When having sound-absorbing materials (plastic, concrete) and/or coating the pipe wall signal is usually weak indicated by low amplitude. The V-mode signal is usually stronger than the W-mode signal.

The time between the different signals might be significantly higher or lower depending on pipe sizes and speed of sound of involved materials.

A different situation occurs when measuring in Z-mode.

FIGURE 65: Signals in Z-mode

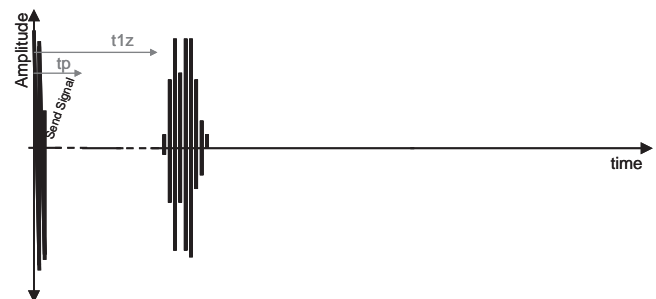

Beside the send signal, only the desired signal (Z-signal) is visible. The Z-signal reaches the receiving transducer after $T=t1z$.

Oscilloscope Menu

With the oscilloscope menu you can analyze signals and even manipulate them in order to handle challenging applications.



QStar UFM sets all necessary parameters for the signal processing. When manipulating signals these settings will change. This might result in a loss of signals and/or failure in measurement. The changes done in the oscilloscope menu might remain valid even when leaving the menu. To get settings from QStar UFM the site should be setup again.

QStar UFM only works with the signals within the measuring window. The measuring window represents a certain period of time which is analyzed by QStar UFM about signals. The measuring window can be moved back and forth by using the arrow buttons.

FIGURE 66: Measuring Window

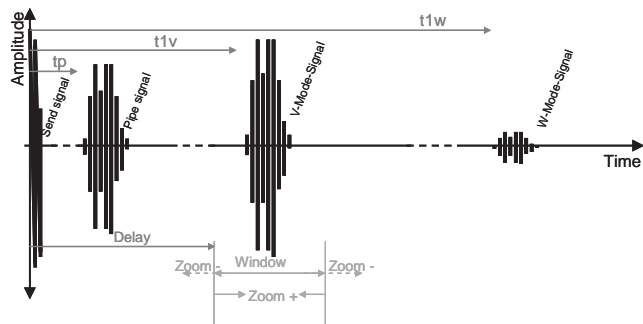

QStar UFM tries to set the measuring window so that only the desired signal (for example, V-mode) is visible.

FIGURE 67: Oscilloscope Menu Showing Desired Signals

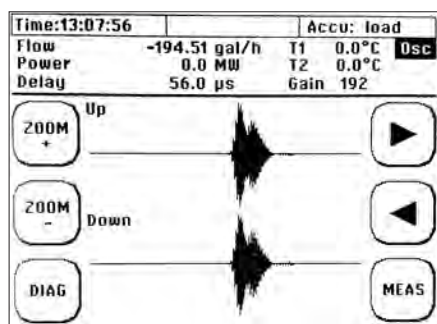

Use ZOOM-/ZOOM+ buttons, to scale-up/scale-down the measuring window (decrease/increase the time the window is open). Use arrow buttons to move window left or right (opens earlier/later).

QStar UFM only uses signals within the window. If you move the window, the signal will disappear and you might get wrong/no measurement.

Information about starting point ("delay") of measuring

window displays (Figure 50). In this picture, window starts at 154 µSec. Use arrow buttons to change this starting time.

Signal Analysis Using Oscilloscope

The oscilloscope allows quick check of signal quality. This helps to get accurate measurements. Good signal to noise ratio and "sharpness" of signals are important for best results.

Signal-to-noise ratio (SN)

SN indicates the difference of amplitudes between the desired signal and the noise. The higher the SN the better the signal processing. Figure 68 shows good signals with very good SN.

FIGURE 68: Oscilloscope Menu Showing Good Signals

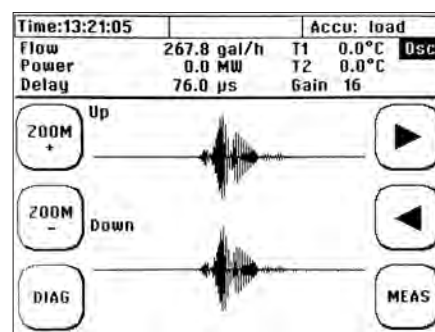

There is almost no noise at all and a clear and distinguished signal.

Figure 69 shows a noisy signal with lower SN. Screen shows noise around the signal which reaches 20-40% of signal.

FIGURE 69: Oscilloscope Menu Showing Noisy Signal

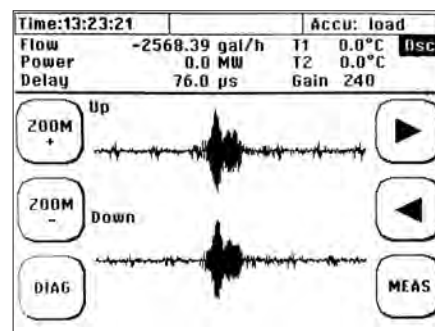

QStar UFM is able to handle noisy signals thanks to its sophisticated signal processing. However, if a high SN is encountered, the user should use caution in case of additional interferences.

If there are problems with your measurement SN can be improved by:

- Surface of pipe: Remove paint or rust
- Coupling grease: Use sufficient coupling grease (MagnaLube).
- Alignment of transducers: Make sure the transducers are mounted as suggested by QStar UFM. Make sure that center of transducers touches the pipe sufficiently (might be a problem with very small pipes). You can check the oscilloscope while mounting the transducers.
- Make sure the transducers are not mounted on welding seams.
- Make sure to remove air from liquid.
- Choose another mounting position (for example, vertical pipe).
- Make sure to provide sufficient straight run.
- Make sure that signal cables are not disturbed by power cables.
- Pumps and motors (with frequency inverters) generate electric noise and should be avoided.
- Use Z-mode rather than V-mode to reduce path length and therefore to increase signal strength.
- Try V-mode rather than W-mode.
- Use stronger transducers, for example, -F05 instead of -F10 or -F10 instead of -F21.

Sharpness of Signals

QStar UFM uses coded signals to make sure to detect signals in case of noise. Coded means QStar UFM makes phase shifts within a signal package.

Figure 70 shows a sharp signal. You can see approximately 5 waves followed by a phase shift and other waves.

FIGURE 70: Sharpness of signals

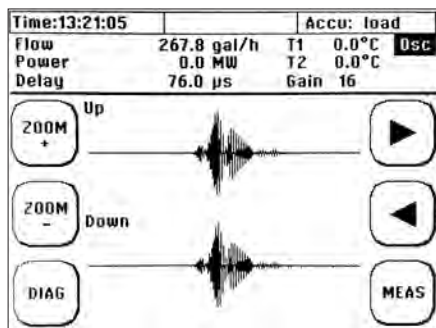
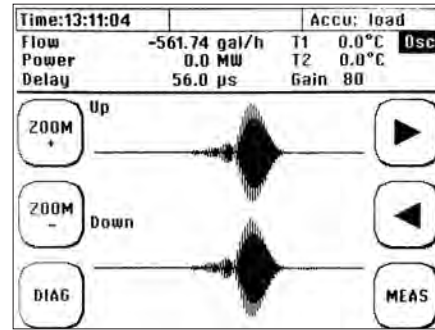

Figure 71 shows diffused signals. There is basically no phase shift. This might result in undetected signals.

FIGURE 71: Diffuse Signals



QStar UFM is able to handle diffused signals until a certain limit. Nevertheless sharp signals should be the goal.

If there are problems, the sharpness can be increased by:

- Choosing different signal sequence
- Using other mounting mode
- Using different transducer
- Improving pipe surface: Removing paint and/or rust
- Making sure to use sufficient amount of coupling grease (MagnaLube)
- Aligning of transducers: Make sure that transducers are mounted as suggested and that the center of transducers touches the pipe sufficiently (might be problem at very small pipes). You can check the oscilloscope while mounting the transducers.
- Making sure that transducers are not blocked by welding seams
- Choosing a different location for measurement

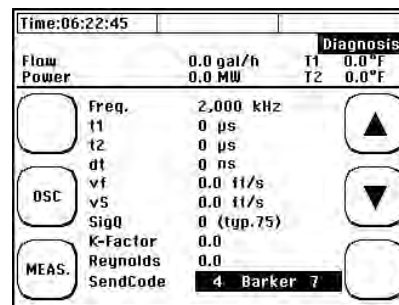

To select a different signal sequence, enter the diagnostic menu (Diag) and press button on the right of parameter SendCode. Usually the signal sequences 3-Barker 5 or 4-Barker 7 are expected to bring best performance. You can try different sequences and check influence in diag-

nostic data (SigQ, see **Troubleshooting: Oscilloscope Menu of QStar UFM**) as well as visually in oscilloscope.

Separating Signals (small pipes)

When measuring at small pipes (<1.9 in.) the distances between the received signals become smaller. In the worst case, signals might interfere as shown in Figure 72 Interfering signals.

FIGURE 72: Interfering Signals

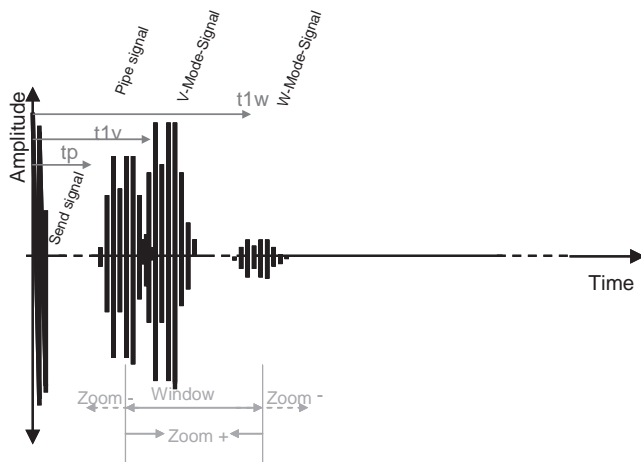

In this case, there are not only the desired signal within the measuring window but also the interfering pipe wall signal and also a part of the W-mode signal.



QStar UFM uses sophisticated algorithms to separate desired signals from interfering signals. These algorithms are mainly applied when having the auto window function activated. But especially when measuring at very small pipes interference might occur anyway. In that case the user can separate signals (in order to filter out the desired signal) manually in the oscilloscope mode.

If interference does occur:

- Use W-Mode rather than V-mode (first counter-measure)
- Use Z-Mode rather than V-mode (when W-mode does not work)
- Deactivate Auto-Window and use ZOOM function/shift function (arrow buttons) to kick out disturbing signals of the measuring window.
- Use different signal sequence, for example, 3-Barker5 or 1Puls rather than 4-Barker 7
- Use transducer working at higher frequency (F21 rather than F10) to get sharper signals. When using F21 (2MHz) instead of F10 (1MHz) the signals become half as wide (half of time) which makes it easier to separate signals.

FIGURE 73: Separated Signals

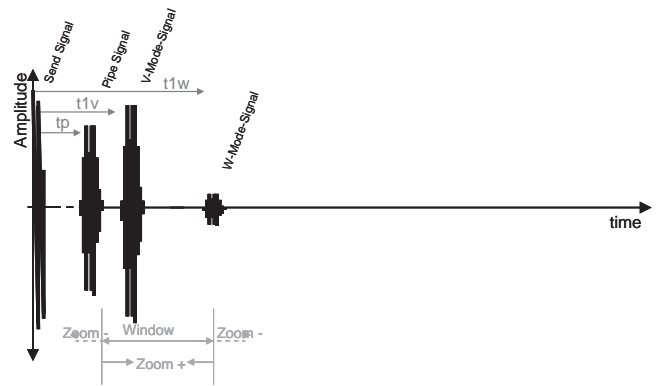

Deactivate the auto-window in order to separate signals manually. Always check the measured speed of sound of the separated signal. When the (separated) desired signal is within the measuring window, the speed of sound (parameter vS in diagnostic menu) should be within +/- 20% of the expected speed of sound (for example, when measuring water at 68° F speed of sound should be within 1400-1500 ft/s). If vS exceeds the expected values you most likely have separated the wrong signal (example, pipe wall signal, then vS is showing speed of sound of pipe material).

Activate/Deactivate Auto-Window

When in main menu “Flow 1”, choose OSZ to enter the oscilloscope menu.

Determine whether to use auto window or not. In case of problems with measurement we recommend to try without auto window first.

Choose “NO”

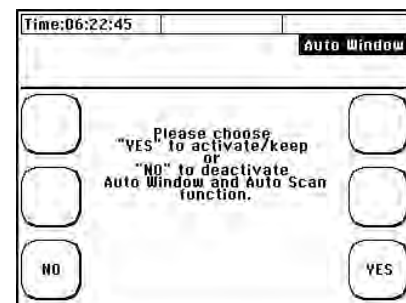

Display shows distinguished signals (UP and DOWN) in the oscilloscope.

Press DIAG and OSZ again to activate auto window. Answer with YES. Check if position of ultrasonic signals have been changed. Check if value for delay has been changed. If yes, use auto window for your measurement. Auto window is activated when you say YES and when you leave oscilloscope mode. To deactivate auto window enter oscilloscope mode again and answer with NO).

DIAGNOSTIC MENU

⚠ CAUTION

The diagnostic menu shows a lot of parameters that are mainly readable for experienced users. The diagnostic data are also suited for troubleshooting.

Diagnostic Window 1:

Time:06:22:45		Accu: 80%		Diagnosis	
Flow	0.0 gal/h	T1	0.0°F		
Power	0.0 MW	T2	0.0°F		
OSC	Freq. 2,000 kHz	t1	0 μs	▲	
	t2 0 μs	t2	0 μs		
	dt 0 ns	df	0.0 ft/s	▼	
	vs 0.0 ft/s	vs	0.0 ft/s		
	SigQ 0 (typ.75)	SigQ	0 (typ.75)		
MEAS.	K-Factor 0.0	K-Factor	0.0		
	Reynolds 0.0	Reynolds	0.0		
	SendCode 4 Barker 7	SendCode	4 Barker 7		

MENU 1: Diagnostic Data

Frequency: Shows the signal frequency which depends on the selected transducer.

There are three different transducers using different frequencies (500kHz, 1000kHz, 2000kHz).

Signal: Shows the type of signal code. Coded signals allow reliable detection of signals.

T1: Signal run time signal 1 (Upstream signal or downstream signal depending on connection of cables).

T2: Signal run time of back signal 2 (Upstream signal or downstream signal depending on connection of cables).

dT: Measured difference between T1 and T2 (minus zero offset if applicable). dT is proportional to flow.

vF: Measured velocity

vS: Measured speed of sound of fluid. Depends on temperature.

SigQ: Number of valid signals (in percentage). QStar UFM makes numerous measurements per second and automatically filters out unreliable signals. The number of measurements in relation to valid measurements is SigQ.

The achievable number is related to the chosen quality (see Menu 2). The higher the quality the lower usually the SigQ. When setting quality to 0 there is basically no filtering of signals and all signals are used for measurement (with the risk of using bad signals).

K-Factor: Factor which compensates the influence when measuring laminar flow ($Re < 8000$). When measuring in that area a (small) additional uncertainty might occur.

Reynolds: The number of Reynolds automatically affects the chosen compensation factor.

Send Code (=signal sequence): The used signal sequence.

Diagnostic Menu 2:

Time:06:22:45		Accu: 80%		Diagnosis	
Flow	0.0 gal/min	T1	0.0°F		
Power	0.0 MW	T2	0.0°F		
OSC	Theta 0.0°			▲	
	Path Length 0.0 mm				
	Delay 0.0 μs			▼	
	XDCR dist. 0.0 mm				
	BAR index 0				
	Gain 0				
	dT Corr 0.0 ns				
	SNR Indices 0				
MEAS.	Max Ampl. 1 0				
	Max Ampl. 2 111				
	Quality 0				

MENU 2: Diagnostic Data

Theta: Angle between ultrasonic path and flow vector.

Path length: Length of acoustic path. Depends on pipe size and on chosen installation mode of transducers.

(Delay): Represents the time when the measuring window starts.

Sensor distance: Distance between the two transducers.

Bar index: Mounting positions when using spacer bar.

Gain: The required amplification (gain) of the signals is automatically set continuously. 0 represents no amplification (not applicable) while 255 represents the maximum amplification. The lower the gain the better the signal transmission. Very high gain might indicate a disturbed signal (gas, particles, wrong mounting).

dT Corr: Time shift of signals created by zero setting.

Quality: The quality parameter represents the "thoroughness" of the internal filter. Filter means that QStar UFM checks each signal if plausible or not using the quality parameter. When choosing quality 0, there will be no filtering. That means that each signal is used for measurement even the bad (and maybe wrong) ones. Filtering of 100 would mean that filtering is very strict. Both values (0/100) are not recommended. Typical values are 50-75. When not getting measurement it might be useful to set quality lower (for example, set to 20).

Diagnostic Menu 3:

Time:06:22:45		Accu: 80%		Diagnosis	
Flow	0.0 gal/h	T1	0.0°F		
Power	0.0 MW	T2	0.0°F		
OSC	t1 (raw value) 0.0 μs			▲	
	t2 (raw value) 0.0 μs				
	dt (raw value) 0.0 ns			▼	
	XDCR Delay 0.0 μs				
	Pipe Delay 0.0 μs				
	Coating Delay 0.0 μs				
	qp 0.0000				
	LambdaCorr 0				
MEAS	Delay Corr 111.00 μs				
	t1a 0.00 μs				

Menu 3: Diagnostic Data
T1/T2 (raw): Signal run times along complete signal path including pipe wall and transducer enclosure.
dt (raw): Measured time difference of T1/T2 (raw).
XDCR (DCR=Transducer): Signal run time within transducer.
Pipe delay: Signal run time within pipe wall.
qp: Compensation factor considering changes in temperature (and therefore changes in speed of sound of fluid).
Coating delay: Delay in signal run time generated by coating (if applicable).
Lambda Corr.: Delay can be manually edited (not recommended, only for maintenance) by multiples of wave length of signal.
Delay Corr: Shows Lambda Corr in seconds.

SOFTWARE UPDATE

Check software version

Before making any software update, check version of software.

Switch off transmitter and restart it. During “start” locate the version at the bottom of start screen (see arrow). Note this value.

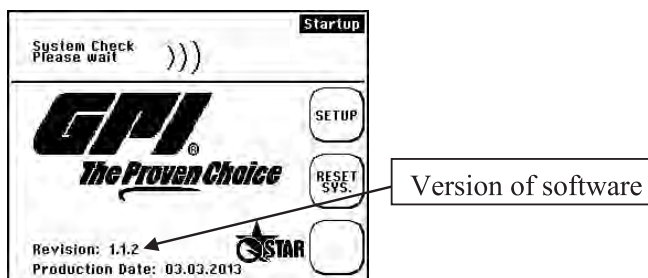

Consult GPI/website for latest revision levels. If you are using an earlier version, contact GPI for updates and procedures.

FLUID PROPERTIES

SPEED OF WATER

° C	V in/s	° C	V in/s	° C	V in/s	° C	V in/s	° C	V in/s
0	1403	21	1486	42	1532	63	1553	84	1554
1	1408	22	1489	43	1534	64	1553	85	1553
2	1413	23	1492	44	1535	65	1554	86	1553
3	1417	24	1494	45	1537	66	1554	87	1552
4	1422	25	1497	46	1538	67	1554	88	1552
5	1427	26	1500	47	1539	68	1555	89	1551
6	1431	27	1502	48	1541	69	1555	90	1551
7	1435	28	1505	49	1542	70	1555	91	1550
8	1439	29	1507	50	1543	71	1555	92	154958
9	1444	30	1509	51	1544	72	1555	93	1549
10	1448	31	1512	52	1545	73	1555	94	1548
11	1452	32	1514	53	1546	74	1555	95	1548
12	1455	33	1516	54	1547	75	1555	96	1547
13	1459	34	1518	55	1548	76	1555	97	1546
14	1463	35	1520	56	1549	77	1555	98	1545
15	1466	36	1522	57	1549	78	1555	99	1544
16	1470	37	1524	58	1550	79	1555	100	1543
17	1473	38	1526	59	1551	80	1555		
18	1476	39	1527	60	1551	81	1555		
19	1480	40	1529	61	1552	82	1554		
20	1483	41	1531	62	1552	83	1554		

° F	V in/s	° F	V in/s	° F	V in/s	° F	V in/s	° F	V in/s
32	55226	69.8	58492	107.6	60330	145.4	61138	183.2	61167
33.8	55422	71.6	58607	109.4	60389	147.2	61156	185	61152
35.6	55613	73.4	58720	111.2	60446	149	61172	186.8	61135
37.4	55800	75.2	58830	113	60501	150.8	61185	188.6	61117
39.2	55983	77	58937	114.8	60554	152.6	61198	190.4	61098
41	56161	78.8	59041	116.6	60604	154.4	61209	192.2	61077
42.8	56335	80.6	59142	118.4	60652	156.2	61218	194	61055
44.6	56506	82.4	59239	120.2	60698	158	61225	195.8	61031
46.4	56672	84.2	59335	122	60743	159.8	61231	197.6	6100709
48.2	56834	86	59427	123.8	60785	161.6	61235	199.4	60981
50	56992	87.8	59516	125.6	60825	163.4	61238	201.2	60954
51.8	57146	89.6	59603	127.4	60863	165.2	61239	203	60925
53.6	57297	91.4	59687	129.2	60899	167	61238	204.8	60896
55.4	57444	93.2	59769	131	60933	168.8	61236	206.6	60865
57.2	57587	95	59847	132.8	60965	170.6	61233	208.4	60832
59	57726	96.8	59924	134.6	60995	172.4	61228	210.2	60799
60.8	57862	98.6	59997	136.4	61024	174.2	61221	212	60764
62.6	57995	100.4	60069	138.2	61050	176	61213		
64.4	58124	102.2	60137	140	61075	177.8	61204		
66.2	58250	104	60204	141.8	61098	179.6	61193		
68	58372	105.8	60268	143.6	61119	181.4	61180		



FLUID PROPERTIES (Continued)

DYNAMIC VISCOSITY

LIQUID	° F	V in/s	° C	pg/cm ³	V m/s	V (x10-6m ² /s)
Acetone	68.00	46850	20	0.7905	1190	0.407
Aniline	68.00	65315	20	1.0216	1659	1762
Ether	68.00	39606	20	0.7135	1006	0.336
Ethylene glycol	68.00	65591	20	1.1131	1666	21.112
Chloroform	68.00	39409	20	1.4870	1001	0.383
Glycerin	68.00	75709	20	1.2613	1923	1188.5
Acetic acid	68.00	45630	20	1.0495	1159	1.162
Methyl acetate	68.00	46496	20	0.928	1181	0.411
Ethyl acetate	68.00	45827	20	0.900	1164	0.499
Heavy water	68.00	54646	20	1.1053	1388	1.129
Carbon tetrachloride	68.00	36929	20	1.5942	938	0.608
Mercury	68.00	57126	20	13.5955	1451	0.114
Nitrobenzene	68.00	57992	20	1.207	1473	1.665
Carbon disulfide	68.00	45591	20	1.2634	1158	0.290
n-pentane	68.00	40630	20	0.6260	1032	0.366
n-hexane	68.00	42638	20	0.654	1083	0.489
Spindle oil	89.60	52126	32	0.905	1324	15.7
Gasoline	93.20	49213	34	0.803	1250	0.4 to 0.5
Water	56.30	57480	13.5	1.	1460	1.004(20°C)

SPEED OF SOUND OF PIPE MATERIALS

Material	V m/s	V in/s
Iron	3230	127165
Steel	3206	126220
Ductile cast iron	3000	118110
Cast iron	2460	96850
Stainless steel	3206	126220
Copper	2260	88976
Lead	2170	85433
Aluminum	3080	121260
Brass	2050	80709
Vinylchloride	2640	103937
Acrylics	2644	104094
FRP	2505	98622
Mortar	2500	98425
Tar epoxy	2505	98622
Polyethylene	1900	74803
Teflon	1240	48819

SPEED OF SOUND SUBJECT TO CHANGE OF TEMPERATURE IN WATER

LIQUID	° C	° F	pg/cm ³	V m/s	V in/s
Acetone	20	68	0.7905	1190	46850
Aniline	20	68	1.0216	1659	65315
Alcohol	20	68	0.7893	1168	45984
Ether	20	68	0.7135	1006	39606
Ethylene glycol	20	68	1.1131	1666	65591
n-octane	20	68	0.7021	1192	46929
o-xylene	20	68	0.871	1360	53543
Chloroform	20	68	1.4870	1001	39409
Chlorobenzene	20	68	1.1042	1289	50748
Glycerin	20	68	1.2613	1923	75709
Acetic acid	20	68	1.0495	1159	45630
Methyl acetate	20	68	0.928	1181	46496
Ethyl acetate	20	68	0.900	1164	45827
Cyclohexane	20	68	0.779	1284	50551
Dithionic acid	20	68	1.033	1389	54685
Heavy water	20	68	1.1053	1388	54646

LIQUID	° C	° F	pg/cm ³	V m/s	V in/s
Carbon tetrachloride	20	68	1.5942	938	36929
Mercury	20	68	13.5955	1451	57126
Nitrobenzene	20	68	1.207	1473	57992
Carbon disulfide	20	68	1.2634	1158	45591
Chloroform	20	68	2.8904	931	36654
n-propyl alcohol	20	68	0.8045	1225	48228
n-pentane	20	68	0.6260	1032	40630
n-hexane	20	68	0.654	1083	42638
Light oil	25	77	0.81	1324	52126
Transformer oil	32.5	91	0.859	1425	56102
Spindle oil	32	90	0.905	1342	52835
Petroleum	34	93	0.825	1295	50984
Gasoline	34	93	0.803	1250	49213
Water	13.5	56	1.	1460	57480
Sea water (salinity: 3.5%)	16	61	1.	1510	59449



SPECIFICATIONS		OSTAR PORTABLE	OSTAR FIXED
Operation:	Intuitive via 8 main keys (Soft Keys), plain text display		
Languages:	English, Spanish and French		
Units:	Metric/US		
Outputs:	2x 4-20 mA, 1x Relay, 1x MicroUSB 1x Pulse	2x 4-20 mA, 1x Pulse, 1x MicroUSB 1x Relay, RS232 (opt.)	
Inputs:	2x PT100		
Integrated Data Logger:	2 GB	N/A	
Data Logged:	Measurement and totalizers	N/A	
Data Format:	Can be exported into standard office programs	N/A	
Memory Cycle:	Adjustable, 1 second to 24 hours	N/A	
Power Supply:	Integrated rechargeable battery and 110V AC adapter Battery Duration: Approximately 5 hours	85-264VAC, 18-36VDC (opt.) Power Consumption: 10 W	
Protection Class:	IP40	IP65, Ex	
Housing:	Aluminium, PVC	PVC, wall-mounted	
Dimensions:	10.4 x 7.5 x 2.7 in.	10.2 x 9.4 x 4.7 in.	
Operating Temp:	-4° F to 140° F		
Transducer Temp:	-40° F to 300° F		
Weight:	3.3 lbs	2.9 lbs	
Display:	QVGA (320x240), black and white, adjustable backlighting		
Carrying Case	20 x 16 x 16	N/A	

MEASUREMENT	
Principle:	Ultrasonic transit time difference with AFC technology
Values Meas:	Flow, flow speed, heat flow
Totalizers:	Heat quantity, volume
Meas. Range:	+/- 98 ft/s
Signal Damping:	0 - 100 sec (adjustable)
Diagnostic Functions:	Acoustic velocity, signal strength, SNR, signal quality, amplitude, energy Oscilloscope function allows graphical display and analysis of signals.

MEASUREMENT ACCURACY		
Inner Diameter Ø	Range	Deviation
.39 - .98 in.	6.56-98.42 ft/s	2.5% of reading
	0-6.56 ft/s	± 0.16 ft/s
.98-1.97 in.	6.56-98.42 ft/s	1.5% of reading
	0-6.56 ft/s	± 0.10 ft/s
1.97-11.81 in.	6.56-98.42 ft/s	1% of reading
	0-6.56 ft/s	± 0.07 ft/s
11.81-236.22 in.	3.28-98.42 ft/s	1% of reading
	0-3.28 ft/s	± 0.03 ft/s
Repeatability for majority of applications is <0.2%		

MODEL NO.	DESCRIPTION	PIPE SIZES
QME05	Ultrasonic Flowmeter (ENERGY-FIXED, .5 MHz)	8" to 240"
QME10	Ultrasonic Flowmeter (ENERGY-FIXED, 1 MHz)	1.5" to 16"
QME20	Ultrasonic Flowmeter (ENERGY-FIXED, 2 MHz)	.5" to 4"
(Above include temperature sensors)		
QMF05	Ultrasonic Flowmeter (FIXED, .5 MHz)	8" to 240"
QMF10	Ultrasonic Flowmeter (FIXED, 1 MHz)	1.5" to 16"
QMF20	Ultrasonic Flowmeter (FIXED, 2 MHz)	.5" to 4"

MODEL NO.	DESCRIPTION	PIPE SIZES
OMP05	Ultrasonic Flowmeter (PORTABLE, .5 MHz)	8" to 240"
OMP10	Ultrasonic Flowmeter (PORTABLE, 1 MHz)	1.5" to 16"
OMP20	Ultrasonic Flowmeter (PORTABLE, 2 MHz)	.5" to 4"
QMF-PT100	Temperature Sensor Kit, FIXED (16 FT)	
OMP-PT100	Temperature Sensor Kit, PORTABLE (16 FT)	
	Pipe Wall Thickness Gauge	



Limited Warranty Policy

Great Plains Industries, Inc. 5252 E. 36th Street North, Wichita, KS USA 67220-3205, hereby provides a limited warranty against defects in material and workmanship on all products manufactured by Great Plains Industries, Inc. This product includes a 1 year warranty. Manufacturer's sole obligation under the foregoing warranties will be limited to either, at Manufacturer's option, replacing or repairing defective Goods (subject to limitations hereinafter provided) or refunding the purchase price for such Goods theretofore paid by the Buyer, and Buyer's exclusive remedy for breach of any such warranties will be enforcement of such obligations of Manufacturer. The warranty shall extend to the purchaser of this product and to any person to whom such product is transferred during the warranty period.

The warranty period shall begin on the date of manufacture or on the date of purchase with an original sales receipt. This warranty shall not apply if:

- A. the product has been altered or modified outside the warrantor's duly appointed representative;
- B. the product has been subjected to neglect, misuse, abuse or damage or has been installed or operated other than in accordance with the manufacturer's operating instructions.

To make a claim against this warranty, contact the GPI Customer Service Department at 316-686-7361 or 888-996-3837. Or by mail at:
Great Plains Industries, Inc.
5252 E. 36th St. North
Wichita, KS, USA 67220-3205

The company shall, notify the customer to either send the product, transportation prepaid, to the company at its office in Wichita, Kansas, or to a duly authorized service center. The company shall perform all obligations imposed on it by the terms of this warranty within 60 days of receipt of the defective product.

GREAT PLAINS INDUSTRIES, INC., EXCLUDES LIABILITY UNDER THIS WARRANTY FOR DIRECT, INDIRECT, INCIDENTAL AND CONSEQUENTIAL DAMAGES INCURRED IN THE USE OR LOSS OF USE OF THE PRODUCT WARRANTED HEREUNDER.

The company herewith expressly disclaims any warranty of merchantability or fitness for any particular purpose other than for which it was designed.

This warranty gives you specific rights and you may also have other rights which vary from U.S. state to U.S. state.

Note: In compliance with MAGNUSON MOSS CONSUMER WARRANTY ACT – Part 702 (governs the resale availability of the warranty terms).



GREAT PLAINS INDUSTRIES, INC.

