

User Manual



PR650

3 Phase Sequence and Non-Contact Motor Rotation Tester



Please read this manual before switching the unit on.
Important safety information inside.

Content	Page
1.Introduction.....	4
2.Safety Information.....	4
3.Symbols.....	5
4.Ships with the Following Items.....	5
5.Meter Description.....	6
6.Operation.....	7
6-1.Determine Rotary Field Direction.....	7
6-2.Non-Contact Rotary Field Indication.....	8
6-3.Determine the Motor Connection.....	9
6-4.Magnetic Field Detection.....	9
7.Battery Replacement.....	9
8.Specifications.....	10

1. Introduction

The Motor and Phase Rotation indicator is a handheld, battery-operated instrument designed to detect the rotary field of three-phase systems and determine motor-rotation direction.

2. Safety Information

 **CAUTION** identifies conditions and actions that may damage the phase rotation indicator.









  **WARNING** identifies conditions and actions that pose hazard to the user.

To avoid possible electric shock or fire, do the following:

- Read the following safety information carefully before using or servicing the instrument.
- Adhere to local and national safety codes.
- Individual protective equipment must be used to prevent shock and injury.
- Use of instrument in a manner not specified by the manufacturer may impair safety features/ protection provided by the equipment.
- Avoid working alone.
- Inspect the test leads for damaged insulation or exposed metal. Check test lead continuity, damage leads must be replaced, do not use the phase Rotation indicator if it looks damaged.
- Be careful when working above 30V ac rms, 42V ac peak and 60V dc, Such voltages pose a shock hazard.
- When using the probes, keep fingers away from probe contacts, keep fingers behind the finger guards on the probes.
- Measurements can be adversely affected by impedances of additional operating circuits connected in parallel or by transient currents.
- Verify operation prior to measuring hazardous voltages (voltages above 30V ac rms, 42V ac peak and 60V dc).
- Do not use the phase rotation indicator with any of the parts removed.
- Do not use the phase rotation indicator around explosive gas, vapor, or dust.
- Do not use the phase rotation indicator in a wet environment.

3.Symbols

The following symbols appear on the Motor and Phase Rotation indicator or in this manual.

	Risk of electric shock
	Risk of Danger, Important information see manual.
	Hazardous Voltage.
	Equipment protected by double or reinforced insulation
	Battery
	Earth
	AC or DC
	Conforms to EU directives
CAT III	Overvoltage (Installation) Category III, Pollution Degree 2 per ICE 1010-1 refers to the level of Impulse withstand voltage protection provided. Equipment of Overvoltage Category III is equipment in fixed installations (e.g., electricity meter and primary over-current protection equipment).
	Recycling information

4.Ships with the Following Items

- 3 Test Leads
- 3 Test Probes
- 3 Alligator Clips
- 9V Battery
- Users Manual

5. Meter Description

- 1-Test Lead Input Jack
- 2-L1 Indicator
- 3-L2 Indicator
- 4-L3 Indicator
- 5-Clockwise Rotation Indicator
- 6-Counter Clockwise Rotation Indicator
- 7-ON/OFF Indicator
- 8-ON/OFF Button
- 9-Brief Instructions on Instrument Rear
- 10-Battery Cover

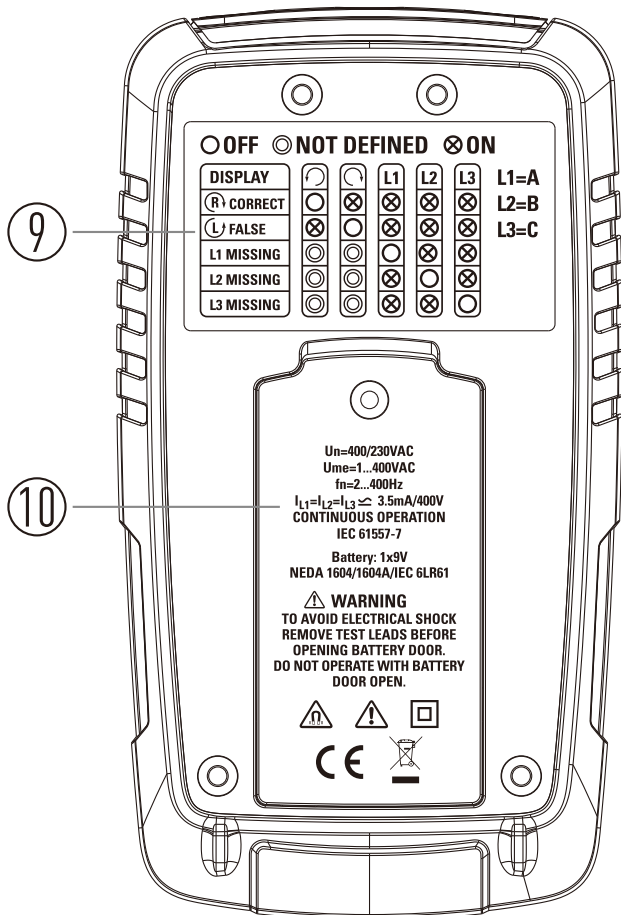
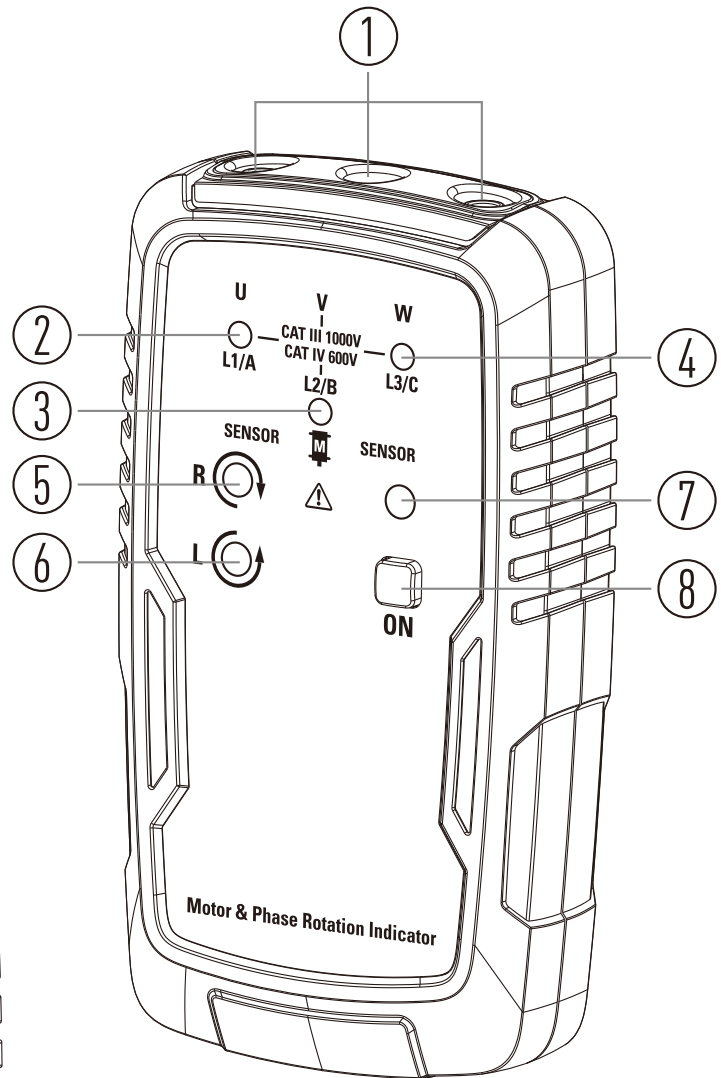

6. Operation

6-1. Determine Rotary Field Direction

1. Connect one end of the test leads to the Motor and Phase Rotation indicator, make sure the L1, L2 and L3 test leads are connected to the corresponding input jacks.
2. Connect the test probes to the other end of the test leads.
3. Connect the test probes to the three mains phases, press the **ON/OFF** Button, the green ON indicator shows that the instrument is ready for testing.
4. Either the Clockwise or Counter Clockwise Rotary indicator illuminates showing the Type of rotary field direction present.
5. The rotary indicator lights even if the neutral conductor, N, is connected instead of the Test lead input jacks.
6. Refer to Figure (Also shown on the back of the Motor and Phase Rotation indicator) for more information.

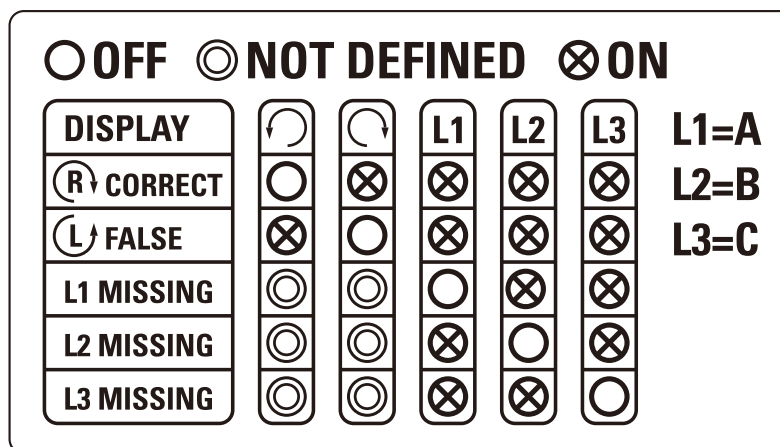

6-2.Non-Contact Rotary Field Indication

- 1.Disconnect all test leads from the Motor and Phase Rotation indicator.
- 2.Position the Indicator on the motor so that it is parallel to the length of the motor shaft, the Indicator should be one inch or close to the motor.
- 3.Press the **ON/OFF** Button, the green ON indicator shows that the instrument is ready for testing.
- 4.Either the Clockwise or Counter Clockwise Rotary indicator illuminates showing the type of rotary field direction present.

Note: The indicator will not operate with engines controlled by frequency converters. The bottom of the Motor and Phase Rotation indicator should be oriented towards the drive shaft. See the Orientation Symbol on the Motor and Phase Rotation indicator.

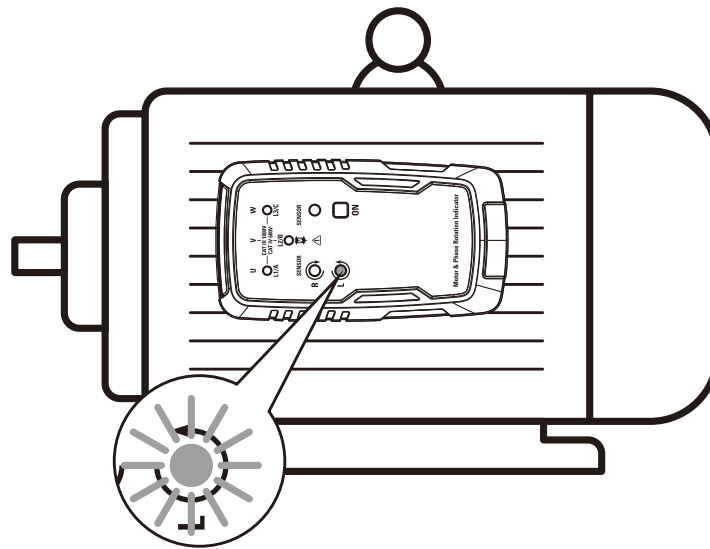

See Table for the minimum motor diameter and number of pole pair to obtain a reliable test result.

Number of Pole Pair	Rotary Number of Rotary Field (1/min) at Frequency (Hz)			Angel Between Poles	Min. Ø of Motorcase
	16 2/3	50	60		
1	1000	3000	3600	60	5.3
2	500	1500	1800	30	10.7
3	333	1000	1200	20	16.0
4	250	750	900	15	21.4
5	200	600	720	12	26.7
6	167	500	600	10	32.1
8	125	375	450	7.5	42.8
10	100	300	360	6	53.5
12	83	250	300	5	64.2
16	62	188	225	3.75	85.6

6-3. Determine the Motor Connection

1. Connect one end of the test leads to the Motor and Phase Rotation indicator, make sure the L1, L2 and L3 test leads are connected to the corresponding jack.
2. Connect the alligator clamps to the other end of the test leads.
3. Connect the alligator clamps to the motor connections, L1 to U, L2 to V, L3 to W.
4. Press the **ON/OFF** Button, the green ON indicator shows that the instrument is ready for testing.
5. Turn the motor shaft half a revolution towards the right.

Note: The bottom of the Motor and Phase Rotation indicator should be oriented towards the drive shaft. See the Orientation Symbol on the Motor and Phase Rotation indicator.

Note: Either the Clockwise or Counter Clockwise Rotary indicator illuminates showing the type of rotary field direction present.

6-4. Magnetic Field Detection

- To detect a magnetic field, place the Motor and Phase Rotation indicator to a solenoid valve.
- A magnetic field is present if either the Clockwise or the Counter Clockwise Rotary indicator illuminate.

7. Battery Replacement

The Motor and Phase Rotation indicator uses a 9V battery (supplied), To replace the battery, follow these steps.

1. Place the Motor and Phase Rotation indicator face down on a nonabrasive surface and loosen the battery-door screw with a screwdriver.
2. Lift the battery access lid away from the Motor and Phase Rotation indicator.
3. Observe the battery polarity shown in the battery compartment.
4. Secure the battery access lid back in position with the screw.

Note: The Motor and Phase Rotation indicator contains alkaline batteries. Do not dispose of these batteries with other solid waste. Used batteries should be disposed of by a qualified recycler or hazardous materials handler.

8. Specifications

Determine Rotary Field Direction

Nominal Voltage Rotary Direction	1 to 400VAC
Nominal Voltage phase indirection	120 to 400VAC
Frequency Range (fn)	2 to 400Hz
Test Currents (In per phase)	Less than 3.5mA

Non-Contact Rotary Field Indication

Frequency Range (fn)	2 to 400Hz
----------------------	------------

Determine the Motor Connection

Nominal Test Voltage (U me)	1 to 400VAC
Nominal Test Currents (In per phase)	Less than 3.5mA
Frequency Range (fn)	2 to 400Hz

Electrical Specifications

Battery	9V alkaline, IEC 6LR61
Current Consumption	Max 20mA
Battery life Minimum	1 year for average use

Safety Specifications

Electrical Safety	Meets DIN VDE 0411, IEC 61010 DIN, VDE 0413-7, IEC 61557-7/EN 61557-7
Maximum Operating Voltage (Ume)	400 V AC for all ranges
Protection Levels	CAT III 1000V and CAT IV 600V

Environmental

Operating Temperature	0 to 40°C
Operating Humidity	15% to 80%
Operating Altitude	2000m
Pollution Degree	2
Type of protection	IP 40

Mechanical Specifications

Size (HxWxD)	135x75x31mm.
Weight	173.9g (With the battery)

Warranty

Triplett / Jewell Instruments extends the following warranty to the original purchaser of these goods for use. Triplett warrants to the original purchaser for use that the products sold by it will be free from defects in workmanship and material for a period of (2) two years from the date of purchase. This warranty does not apply to any of our products which have been repaired or altered by unauthorized persons in any way or purchased from unauthorized distributors so as, in our sole judgment, to injure their stability or reliability, or which have been subject to misuse, abuse, misapplication, negligence, accident or which have had the serial numbers altered, defaced, or removed. Accessories, including batteries are not covered by this warranty.

Copyright © 2023 Triplett

www.triplett.com