

Precision Pressure Measurement

User Guide to Pressure Measurement

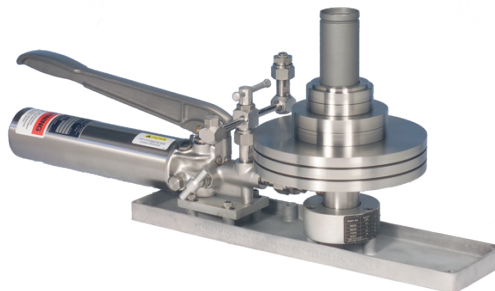

Table of Contents

Chapter 1—Fundamentals of Pressure Measurement

1.1 Gauge Versus Absolute Pressure	4
1.2 Nominal Versus Actual Pressure	4
1.3 Units of Pressure Measurement	4
1.4 Units of Mass Measurement	5
1.5 Gravity	5
1.6 Primary and Secondary Pressure Standards	5

Chapter 2—Deadweight Pressure Testers

2.1 Piston Gauge Type Deadweight Testers	6
2.1.1 Simple Piston & Cylinder	6
2.1.2 Re-entrant Piston & Cylinder	6
2.1.3 Controlled Clearance Piston & Cyl.	7
2.2 Floating Ball Type Deadweight Testers	7
2.3 Other Types of Deadweight Testers	8
2.4 Intrinsic Pressure Correction Terms	8
2.4.1 Air Buoyancy	9
2.4.2 Thermal Expansion	9
2.4.3 Surface Tension	9
2.4.4 Tare Force	9
2.4.5 Area	9
2.4.6 Pressure Coefficient	9
2.5 Site Location Correction Factors	10
2.5.1 Gravity	10
2.5.2 Temperature	10
2.5.3 Test Level	11
2.6 Traceability and Uncertainty	11
2.6.1 Traceability	11
2.6.2 Laboratory Uncertainty	12

Chapter 3—Calibration of Deadweight Testers

3.1 Methods of Calibration	13
3.1.1 Fundamental Characterization	13
3.1.2 Calibrated Characterization	13
3.2 Test Equipment for a Pressure Standards Lab	13
3.2.1 Introduction	13
3.2.2 Hydraulic Piston & Cylinder Type Testers	14
3.2.3 Pneumatic Floating Ball Type Testers	15
3.3 Frequency of Calibration	16
3.3.1 Piston & Cylinder Hydraulic Deadweight Testers	16
3.3.2 Floating Ball Pneumatic Deadweight Testers	16

Chapter 4—AMETEK Deadweight Testers

4.1 Deadweight Testers and Deadweight Gauges	18
4.2 Features of AMETEK Hydraulic Deadweight Testers	18
4.2.1 Model T & R Hydraulic Testers	20
4.2.2 Model 10 Hydraulic Testers	21
4.2.3 Model HL Hydraulic Testers	22
4.2.4 Dual Column Hydraulic Testers	22
4.3 Features of AMETEK Deadweight Gauges	22
4.3.1 Model HLG Deadweight Gauge	23
4.4 Features of AMETEK Pneumatic Deadweight Testers	24

Table of Contents

4.4.1 Model PK II Pneumatic Tester	26
4.4.2 Model RK Pneumatic Deadweight Tester	27
4.4.3 Model HK Pneumatic Deadweight Tester	27
4.4.4 Model PK Medical Pneu. Deadweight Tester	28
4.5 Care of AMETEK Deadweight Testers	28
4.5.1 Hydraulic Deadweight Testers	28
4.5.2 Floating Ball Pneumatic Testers	30
4.6 Procedures for the Use of AMETEK Testers	31
4.6.1 Procedures for Cleaning Hydraulic Piston & Cylinder	31
4.6.2 Procedures for Use of Hydraulic Deadweight Testers	32
4.6.3 Procedures for Use of Hydraulic Deadweight Gauges	33
4.6.4 Procedures for Use of Pneumatic Deadweight Testers	34
Chapter 5—Manometers	
5.0 Principle of Operation	36
5.1 Types of Manometers	36
5.1.1 U Tube Manometers	36
5.1.2 Inclined Tube Manometers	36
5.1.3 Well Type Manometers	37
5.2 Intrinsic Correction Factors	37
5.2.1 Fluid Density Correction	37
5.2.2 Gravity Correction	38
5.2.3 Pressure Medium Head Correction	39
5.2.4 Scale Correction	40
5.2.5 Compressibility, Absorbed Gases and Capillary Considerations	40
5.2.6 Parallax (Readability)	41
Chapter 6—Secondary Comparison Pressure Standards	
6.1 Types of Secondary Comparison Pressure Stds.	42
6.1.1 Mechanical Pressure Gauges	42
6.1.2 Electronic Pressure Gauges	42
6.2 Overall Application Accuracy	43
6.2.1 Application Task	43
6.2.2 Accuracy Measurement	43
6.2.3 Hysteresis, Linearity, Repeatability	44
6.2.4 Temperature Effect	45
6.2.5 Resolution	46
6.2.6 Stability	46
6.2.7 Laboratory Uncertainty	46
6.2.8 Overall Accuracy	47
Chapter 7—Selection of a Pressure Measurement Standard	
7.1 Application Considerations	49
7.1.1 Test Fluid	49
7.1.2 Pressure Range	49
7.1.3 Task to be Performed	49
7.2 Cost of Measurement	49
7.2.1 Custody Transfer	50
7.2.2 Process Control	51
7.2.3 Safety	51
7.2.4 Maintenance	51
7.3 Summary & Conclusions	52

Chapter 1

Fundamentals of Pressure Measurement

Pressure, by definition, is a derived parameter. One cannot create an artifact of one pound per square inch or any other measure of pressure. Pressure is derived by the combination of a mass measurement imposed upon an area. It is commonly expressed in terms of pounds force or per unit area (Pounds per square inch). Pressure can also be expressed in terms of the height of a liquid column (Inches of water or millimeters of mercury) that produces the same pressure at its base.

1.1 Gauge Versus Absolute Pressure

Pressure measurements are always expressed as the difference between the measured pressure and some base pressure. Gauge pressure is the pressure measured from, or in addition to, atmospheric pressure. Gauge pressure is normally expressed in terms such as PSIG or pounds per square inch gauge. Absolute pressure is measured from a base of zero pressure and is expressed as PSIA or pounds per square inch absolute. Negative pressures such as vacuum are expressed as the difference between atmospheric pressure and the measured pressure. Vacuum or negative pressures are normally expressed as inches or millimeters of mercury or water vacuum.

1.2 Nominal Versus Actual Pressure

The accuracy of the generated pressure is measured as the difference between the actual pressure produced by the pressure standard and a standard pressure to be used for the calibration of a secondary standard pressure measuring instrument. AMETEK deadweight testers are referred to "Nominal" or even unit pressures, such as 1000, 2000, 3000 PSIG etc. Pressure standards manufactured by other manufacturers, Ruska, D.H., refer the output pressure to the actual output pressure as stated on the certification or computed by an equation included within the certification.

AMETEK accuracy is therefore the difference between the output pressure and the nominal pressure stated in percentage of the reading. AMETEK further states the ability of the instrument to repeat identical pressures with identical weights and piston as the percentage of "Repeatability". Ruska, D&H accuracy as stated is the statistical ability of the instrument to repeat the identical pressure with the same weights and piston. This is comparable to AMETEK's stated percentage for instrument repeatability.

1.3 Units of Pressure Measurement

Pressure is measured in several different units depending upon the application and the country in which the measurement is taken. Within the United States, the most common unit of measure is Pounds (Force) per Square Inch, for low pressure measurements a measure of Inches of Water Gauge and for vacuum Millimeters of Mercury Vacuum. The official unit of pressure measurement within United States is the Pascal which is defined as Newton per square meter. A detailed listing of the various measures of pressure and the equivalent pressure in pounds per square inch is as follows:

Low Pressure

Inches of Water Gauge (20°C) =
0.036063 PSI (ISA RP 2.1)

Inches of Water Gauge (60°F) =
0.036092 PSI (AGA Report 3)

Inches of Water Gauge (4°C) = 0.036126 PSI
Millimeters of Water Gauge (20°C) = 0.0014198 PSI
Millimeters of Water Gauge (4°C) = 0.00142228 PSI

Vacuum

Inch of Mercury (0°C) = 0.49114999 PSI
Torr = 1 Millimeter of Mercury (0°C) = 0.019718 PSI
Millimeters of Mercury (20°C) = 0.019266878 PSI

Pressure

Pascal = 1 Newton/Meter² = 0.0001450377 PSI
Bar = 100 Kilopascal = 14.50377 PSI
Kilogram (Force) per Square Meter = 14.22334 PSI

1.4 Units of Mass Measurement

The term mass as used in the mathematical expressions for pressure is understood to be the true mass or the mass value that would be measured in a vacuum. Although this is the value required for the pressure equation, many different methods have been used by both deadweight tester manufacturers and calibration facilities. These methods fall into two categories: true mass and apparent mass versus some material of a different stated density. Typical materials and conditions for apparent mass are brass with a density of 8400 kg/m³ and stainless steel at 8000 kg/m³, both measured at 20°C.

1.5 Gravity

The term force that is used within the deadweight tester mathematical expression for pressure is defined as the mathematical product of the true mass and the local gravity. The total variation due to gravity over the surface of the earth can vary as much as 0.5%. Acceleration due to gravity can be calculated as follows:

$$g = 980.6160 (1 - 0.0026373 \cos 2\phi + 0.0000059 \cos^2\phi)$$

Where ϕ is the latitude at sea level and

$$g_1 = g_0 - .0003086 h + .0001118 (h - h_1)$$

Where h_1 is the elevation, in meters, of the general terrain for a radius of 70 km and h , in meters, is the elevation of the location above sea level.

An exact measurement of a specific location can be achieved by the conduct of a gravimetric survey. An estimate of local gravity for continental United States locations is available at nominal cost from the United States Department of Commerce, National Ocean Survey (301-713-3242).

1.6 Primary and Secondary Pressure Standards

Primary pressure standards must be directly traceable to the physical standards of length and mass, and any errors must either be eliminated or evaluated. Within the deadweight tester the area of the piston and cylinder or the ball and nozzle can be measured and directly traceable to the physical standard of length. The weights can be measured directly traceable to the physical standard of mass. The only other pressure measurement device that fulfills this definition of primary is the U tube manometer wherein the column difference is traceable to length and the fluid density is traceable to both mass and length.

All other devices for measuring pressure, regardless of accuracy, uncertainty, etc. are considered as secondary. This includes electronic, quartz tube, vibrating cylinder, etc. type pressure measuring instruments.

Chapter 2

Deadweight Pressure Testers

Deadweight pressure testers derive pressure by the combination of a mass, usually weights, which are floated on a piston and cylinder combination with a defined area. The basic equation for the deadweight tester is:

$$P = F/A$$

Where:

- P = the pressure being derived
- F = the force applied by the weights
- A = the effective area of the piston cylinder

2.1 Piston Gage Type Deadweight Testers

Within a piston gage or deadweight tester, a platform containing calibrated weights is balanced upon a piston which is floated within a cylinder. The fluid can be either a liquid, a hydraulic deadweight tester, or a gas, a pneumatic deadweight tester.

Piston gages commonly incorporate three designs of cylinders; the simple cylinder, the re-entrant cylinder and the controlled clearance cylinder.

2.1.1 Simple Piston and Cylinder

As illustrated on Figure 2-1, within the simple piston and cylinder design the test fluid is connected into a chamber below the interior of the cylinder, the weights are suspended upon the piston and the piston is floated upon the pressurized test fluid.

Since the pressure is applied only to the interior of the cylinder, increasing pressures result in the expansion of the cylinder bore and reduction of the piston diameter, thus increasing the effective area of the combination. This combination of effects results in an increased clearance between the piston and cylinder. This increased clearance results in an increased leakage of the test fluid, thus limiting the available test time before fluid replenishment. For these reasons, the simple piston cylinder design is used primarily within pneumatic piston and cylinder gages and hydraulic piston and cylinder gages below 10000 PSI (690 bar).

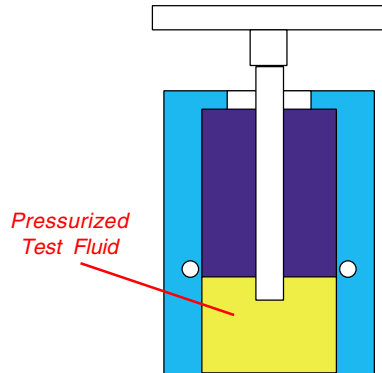

Figure 2-1
Simple Type Piston & Cylinder

2.1.2 Re-entrant Piston & Cylinder

As illustrated on Figure 2-2, within the re-entrant piston and cylinder design the test fluid is connected to a chamber on the outside of the cylinder as well as being connected to the interior of the cylinder. In operation, since the area of the outside of the cylinder is larger than the inside increasing test pressures will reduce the bore of the cylinder as well as reduce the diameter of the piston. The net effect of these reductions will be to reduce the effective area and clearance between the piston and cylinder at high pressures. The available test time is not restricted by the excessive loss of test fluid. The re-entrant type piston and cylinder design is used in all pressure ranges, including high pressures exceeding 50000 PSI (3450 bar).

2.1.3 Controlled Clearance Piston & Cylinder

The controlled clearance piston and cylinder is similar to the re-entrant piston and cylinder except that the chamber on the outside of the piston and cylinder is connected to a separate source of calibration pressure. As illustrated on Figure 2-3, the calibration pressure can be adjusted at each point of pressure measurement to maintain the effective diameter of the cylinder.

In operation, this type of piston gage although very accurate is very slow to operate and very expensive to purchase. It is used primarily by

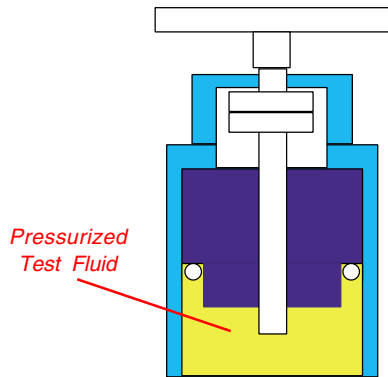

Figure 2-2
Reentrant Type Piston & Cylinder

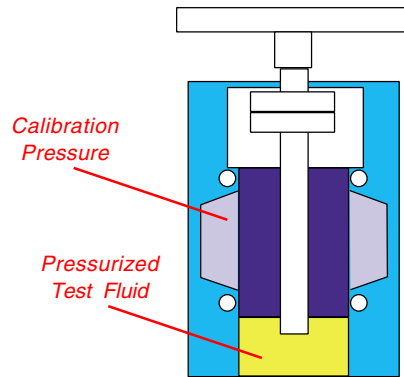

Figure 2-3
Controlled Clearance Type Piston & Cylinder

standards laboratories such as the National Institute of Standards and Technology (NIST) in the United States.

2.2 Ball Type Deadweight Tester

Ball type deadweight gages measure pressure in terms of force over unit area. These instruments operate identical to piston gages except that a ball is used instead of a piston.

A schematic diagram of the AMETEK ball gage is shown on Figure 2-4. In this instrument, clean air is supplied from a flow regulator to an equalizing annulus and from there to a spherical chamber under the ball and to the output port. In operation the ball, with weight hanger and weights suspended from it, floats on a film of air with virtually no friction. The nozzle bore is tapered in the area where the circumference of the ball is located. This taper permits a variable exhaust flow which functions in a pneumatic feedback loop together with the flow regulator to maintain the ball in a fixed vertical position. Pressure builds up within the spherical chamber below the ball until the ball and the weights are suspended. The pressure within the spherical chamber is ported through stabilizing tubing to eliminate pressure oscillations.

2.3 Other Types of Piston Gages

A vacuum-backed piston gage is designed to measure absolute pressure. This instrument is similar to the conventional piston gage except that both the piston and cylinder and the weights operate within a vacuum evacuated bell jar. The pressure within the evacuated chamber must be measured accurately to arrive at the total absolute pressure being measured by the instrument.

The tilted piston gage is designed to operate at lower pressures. Since lower pressures are limited by the weight of the piston itself, the weight can be reduced by using a hollow piston, backing it with a vacuum, and tilting the assembly.

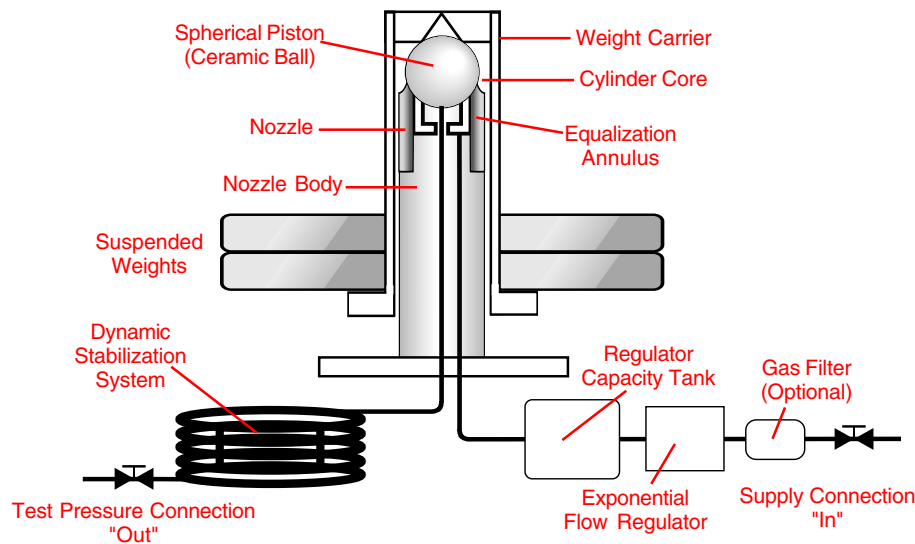

Figure 2-4
Schematic Diagram - Floating Ball-type Deadweight Tester

2.4 Intrinsic Correction Terms

As described by P.L.M. Heideman and B.E. Welch, United States National Institute of Standards and Technology¹, the pressure P generated by a piston gage at its reference level is given by the following equation:

$$P = \frac{\sum Mg \left(1 - \frac{\rho_{\text{air}}}{\rho_M}\right) + \gamma C + T_w}{A_0 [1 + (\alpha_c + \alpha_p)(T - T_{\text{ref}})] [1 + bp]}$$

Where:

- M, ρ_M = Mass and density of weights
- g_i = Local gravity
- ρ_{air} = Density of air at the temperature, barometric pressure and humidity prevailing in the laboratory
- γ = Surface tension of the pressure-transmitting fluid
- C = Circumference of the piston where it emerges from the fluid
- T_w = Tare weight or error
- A_0 = Effective area of the assembly at zero pressure
- α_c, α_p = Thermal expansivities of cylinder and piston
- T = Temperature of the assembly
- T_{ref} = Temperature at which A_0 is referred
- b = Pressure coefficient of the effective area

2.4.1 Air Buoyancy Correction

The term $(1 - \rho_{\text{air}}/\rho_M)$ is the air buoyancy correction for weight M . The density of brass weights is 8.4 grams/cm³ and the density of stainless steel weights is 8.0 grams/cm³. The density of moist air has been tabulated^{2,3}. It can be computed from the equation

$$\rho_{\text{air}} = 1.2929 \times 10^{-3} \left(\frac{273.13}{T}\right) \rho_{\text{bar}} - 0.3783 \text{ Hp}_{\text{sat}}$$

2.4.1.1 Air Buoyancy

The air buoyancy correction must be carefully evaluated. For a measurement at 23°C, 30% relative humidity, 1000 mb barometric pressure and stainless steel weights, the correction would be 147.5 ppm or 0.00147%.

2.4.2 Thermal Expansion

The term $[1 + (\alpha_c + \alpha_p)(T - T_{\text{ref}})]$ corrects the area for thermal expansion. This correction does not contribute significantly to accuracy. For a tungsten carbide piston inside a steel cylinder the correction amounts to 17 ppm or 0.00017% with $T - T_{\text{ref}} = 1^\circ\text{C}$.

2.4.3 Surface Tension

The term γC describes the force generated by the surface tension of the fluid acting on the piston where it emerges from the fluid. γ is the surface tension of the fluid and C is the circumference of the piston. The value of Spinesso 38 is representative for many oils used in piston gages. For a piston of 32 mm² cross sectional area this correction amounts to about 10⁻⁴ Newtons. This constitutes a minimal correction at high pressures, but for low pressure oil gages it should always be taken into account. This correction does not apply to air-operated gages.

2.4.4 Tare Force

T_w is the tare force which may result from an error in the determination of the mass of one of the weights or in computation of the head corrections; it might also be characteristic of a gage.

2.4.5 Area

A_0 is the cross sectional area of the piston. This area can be determined in two different methods. The first method is to perform numerous measurements of the diameter along the length of the piston and transform these measurements using a suitable mathematical model. An alternative method is to cross-float a piston against another piston or instrument of known pressure or effective area.

2.4.6 Pressure Coefficient

The term $(1 + bP)$ describes the change of effective area with pressure. This is the most important correction term. The pressure coefficient is determined by the mathematical expression¹:

$$\begin{aligned}
 b = & \frac{1 - 3\mu}{2Ep} && \text{Piston Distortion} \\
 & + \frac{(1 + \mu_c) R_c^2 + (1 + \mu_c) r_c^2}{2E_c (R_c^2 - r_c^2)} && \text{Cylinder Distortion due to internal pressure} \\
 & - \left(\frac{p_o}{pE_c} \right) \left(\frac{2R_c^2}{R_c^2 - r_c^2} \right) && \text{Cylinder Distortion due to external pressure} \\
 & + \left(\frac{p_e}{p} \right) \left(\frac{\mu_c}{E_c} \right) && \text{Cylinder Distortion due to end loading}
 \end{aligned}$$

Where:

- μ = Poissons ratio
- E = Modulus of elasticity
- r_c = Inside cylinder radius
- R_c = Outside cylinder radius
- r_p = Radius of a solid piston
- p = End pressure on piston
- p_c = Pressure surrounding the piston in the clearance between the piston and cylinder
- p_o = Pressure on outside of the cylinder
- p_e = Pressure on the end faces of the cylinder

Depending upon the design and the materials of construction of a piston and cylinder, the pressure coefficient can be either positive (Area increases) or negative (Area decreases), and that under certain conditions it could approach zero (Constant area).

2.5 Site Location Correction Factors

AMETEK Certification of Accuracy states the accuracy of each deadweight tester based on specific conditions for the gravity and for the temperature. Corrections to the pressures stated in the Certification can be made to compensate for the actual conditions at the test site as follows:

2.5.1 Gravity

If the local gravity at the test site is different from the gravity for which the deadweight tester was calibrated, the actual pressure as shown on the Calibration Report can be converted to actual pressure at the test site through the use of the following formula:

$$P_L = P_A \times G_L / G$$

Where:

- P_L = Actual Pressure at the local gravity of the test site
- P_A = Actual Pressure as shown in the Calibration Report
- G_L = Local Gravity in Gals. (cm/sec²)
- G = Gravity for which the deadweight tester was calibrated in Gals. (cm/sec²)

An example of this correction would be a reading of 3000 PSIG, taken at a site with a local gravity of 979.2 Gals., the tester calibrated for International standard gravity 980.665 Gals.

$$P_L = 3000 \times 979.2 / 980.665$$

or

$$P_L = 2995.518 \text{ PSIG}$$

2.5.2 Temperature

If the temperature at the test site is different from the temperature for which the deadweight tester was calibrated, the actual pressure as shown on the Calibration Report can be converted to actual pressure at the test site through the use of the following formula:

$$P_L = \frac{P_A}{1 + A \times (T_s - T)}$$

Where:

- P_L = Actual Pressure at the temperature of the test site
- P_A = Actual Pressure as shown on the Calibration Report
- A = Thermal Coefficient per °C as shown on the Calibration Report
- T_s = Temperature in °C at the test site
- T = 23°C, the Reference calibration temperature

An example of this correction would be a reading of 100 Inches of Water (60°F), taken at a site with a local temperature of 40°C (104°F). The AMETEK Model PK II Deadweight Tester has a thermal coefficient of 0.0000167 per °C.

$$P_L = 100 + 100 \times 0.0000167 (40 - 23)$$
$$= 100 + 0.02839$$
$$= 100.02839 \text{ inches W.C.}$$

2.5.3 Test Level

If the instrument being calibrated by a deadweight tester is not at the same height as the tester, compensation for the difference in height must be made. This compensation can be made using the following formula:

$$P_L = P_A + P_A \times (H_i - H_t) \times D_f$$

Where:

- P_L = Actual pressure applied to the instrument under test
- P_A = Actual pressure shown in the Calibration Report
- H_i = The calibration height of the deadweight tester (A height line is on the T & R weight carrier, the major diameter of the PK II ball).
- H_t = The calibration height of the instrument being calibrated.
- D_f = Density of the fluid being used for calibration (Oil, water, etc.)

An example of this correction would be a measurement of 100 PSIG, using an AMETEK Model T tester (H₂O), where the instrument being calibrated is located on a platform 20 feet (6 meters) above the tester:

$$P_L = 100 + (0 - 20) \times 62.4 \text{ #/ft.}^3 / 144$$
$$= 100 - 8.666$$
$$= 91.334 \text{ PSIG}$$

2.6 Traceability and Uncertainty

The parameters of both traceability and uncertainty are concerned with the accuracy of measurement within the laboratory that conducted the testing on the pressure standard. Traceability is a measure of the ability of the laboratory to trace the calibration of a pressure standard through a direct chain of calibrations to a national standards laboratory such as the United States National Institute of Standards and Technology. Uncertainty is an estimate of the measurement accuracy of the traceability chain of calibrations.

2.6.1 Traceability

Traceability in United states is defined as the ability to demonstrate conclusively that a particular instrument or artifact either has been calibrated by NIST at accepted intervals or has been calibrated against another standard in a chain or echelon of calibrations ultimately leading to a calibration performed by NIST⁴.

All testers produced by AMETEK are directly traceable to NIST. This traceability of deadweight testers is shown on Figure 2-5. As shown on this diagram, AMETEK sends master testers to NIST on a regular interval for testing. These master testers are then utilized on an annual basis to calibrate working master testers within the AMETEK Standards Laboratory. The working masters are used to test and calibrate all new and repaired testers prior to shipment.

2.6.2 Laboratory Uncertainty

In general, the result of a measurement, such as pressure, is only an approximation or estimate of the specific quantity subject to measurement, and the result is complete only when accompanied by a quantitative statement of its uncertainty⁵. To state this in a different way, a measurement, such as accuracy, is only as good as the technique and equipment used to take the measure, and the accuracy of the standard against which the accuracy was measured. The overall uncertainty must take into account all testing between the national standard (NIST) and the instrument to which the uncertainty is assigned.

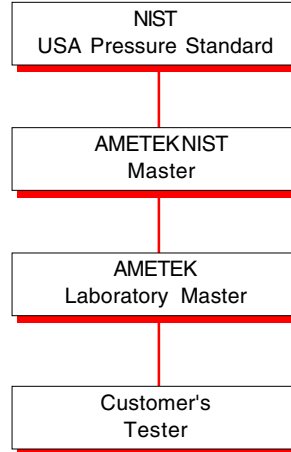

Figure 2-5
Traceability Path
AMETEK Deadweight Testers

The measurement uncertainty of the deadweight testers has been estimated for all of the deadweight testers that are currently being produced⁶. Within this analysis all of the terms which effect the calibration process were evaluated to establish an estimate of the uncertainty of pressure measurement within the AMETEK Standards Laboratory. This measurement, when combined with the NIST uncertainty, is an estimate of the overall uncertainty of testers produced by AMETEK.

The factors contributing to uncertainty of the AMETEK Laboratory included the following:

1. Laboratory conditions. The effect of temperature, pressure and relative humidity on the air density in the vicinity of the weights.
2. Accuracy of the mass values that were used to certify the balances used to measure weights at AMETEK.
3. The effects of surface tension, fluid head and thermal expansion on the piston during the testing.
4. The sensitivity and uncertainty of the cross-float measurement instrumentation.
5. The uncertainty of the master testers as reported to AMETEK by NIST.
6. The local gravity at the AMETEK laboratory.
7. The pressure range of calibration on each dead weight tester.

Currently, equipment specifications and advertisements include only claims on the accuracy of deadweight testers and do not include the uncertainty on the accuracy measurement. The traceability path and uncertainty measurement within the AMETEK Pressure Standards Laboratory as reported are well above industry average.

Future efforts on a United States national level including laboratory accreditation (Already in place in Europe and Asia) should require that both the accuracy and uncertainty levels of instruments such as deadweight testers be reported.

Chapter 3

Deadweight Tester Calibration

Deadweight testers can be calibrated using either the “Fundamental” or “Calibrated” methods to measure the pressure and effective area. A fundamental calibration involves having the effective area of the gauge determined using only measurements of the SI base units (e.g. mass, length) plus a suitable model. A calibrated calibration has the effective area determined via calibration against a gauge for which the effective area or generated pressure is already known.

3.1 Methods of Calibration

3.1.1 Fundamental Characterization of Deadweight Testers

The dimensional characterization of both the piston and cylinder are usually performed under conditions of atmospheric pressure and room temperature. Depending upon the shape of both the piston and the cylinder and the support structure for the mass loading mechanism, the detailed dimensional characterization is usually confined to that part of the piston that is inside the cylinder during normal operation. Pistons of unusual shape are not normally characterized using this technique.

Once a set of dimensional measurements has been performed on both the piston and cylinder, there are several ways in which the area of both the piston and cylinder can be specified. Depending upon the severity of the departure of the piston surface from true cylindricity, an average radius of the piston and cylinder may be calculated, or more sophisticated approaches including distortion of the piston by the applied pressure and thermal expansion of the piston can be applied. The overall area of the piston and cylinder assembly is then computed using an appropriate mathematical model.

This technique is used primarily by national standards laboratories, such as the National Institute of Standards and Technology, that are responsible for establishing reference measurements for a larger group such as the United States.

3.1.2 Calibrated Characterization of Deadweight Testers

The calibrated characterization of deadweight testers involves the transfer of effective areas of one piston and cylinder to another utilizing pressure based cross-float techniques. To use this technique, identical piston and cylinders are placed in identical mountings with the output pressures connected. Means, such as a differential pressure meter are included to identify the time when a pressure balance between the two pressure generating components has been achieved at the reference levels of both the test and reference units. During the test the weights are exchanged on the columns and the piston and cylinders are exchanged in the mountings to reduce the uncertainty of measurement. This technique is used primarily by industry and calibration laboratories. The reference or master pressure generating units (Piston-Cylinder & Weights) are usually tested at a standards laboratory (AMETEK masters are tested at NIST).

3.2 Test Equipment for a Pressure Standards Laboratory

Many different combinations and assemblies of equipment may be utilized with varying degrees of uncertainty of measurement (See paragraph 2.2). We will use for purposes of illustration, the equipment that is used within the AMETEK Pressure Standards Laboratory.

3.2.1 Hydraulic Piston-Cylinder Deadweight Testers

The equipment, as illustrated on Figure 3-1, consists of four identical column assemblies to hold the master piston and cylinders and one identical column to hold the piston and cylinder under test. Each of the master columns contains a master piston of a single range (0.01, 0.020, .05, 0.1 in²) to minimize disassembly after calibration. Master weights with known mass are used on both the test and master piston and cylinders. A analog differential pressure meter is used to indicate when a pressure balance is achieved. A cross-over valve permits interconnection of the output

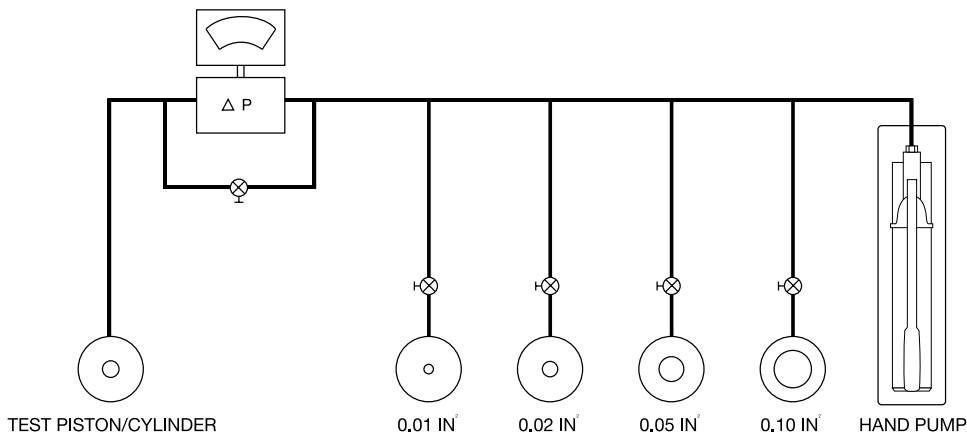

Figure 3-1
Test Equipment for a Hydraulic Piston and Cylinder Pressure Calibration Laboratory

pressure generating components. The pressure balance is illustrated by the following equation:

$$\frac{M_u \times g_i}{A_u} = \frac{M_m \times g_i}{A_m}$$

Which simplifies to:

$$A_u = \frac{A_m (M_u \times g_i)}{(M_m \times g_i)}$$

Where:

- A_u = Area of the unknown piston and cylinder
- A_m = Area of the master piston and cylinder
- M_u = Known mass of the test weights
- M_m = Known mass of the master weights
- g_i = Local gravity

The procedure for calibration of a piston and cylinder with an unknown effective area consists of the following steps:

1. The unknown piston and cylinder is cleaned and installed in the test column.
2. Pressure is applied to both the unknown piston and cylinder and the master piston and cylinder to bring both pistons to position in the middle of the vertical float range.

3. Both pistons are rotated approximately 30 RPM and the cross-over valve is closed.
4. The pressure differential between the master and the test piston-cylinders is indicated on the null meter.
5. Tare weights are added to the piston-cylinder that is low in pressure until the null meter shows a pressure balance. The required tare weights are recorded on the test log.
6. A small tare weight is placed upon the opposite piston and cylinder to unbalance the pressure to the opposite side. This test assures that the piston was free and sensitive when the pressure balance was measured.
7. The steps 2-6 are repeated for each required test pressure.
8. The effective area of the unknown piston and cylinder is determined using the equation in paragraph 2.4 (AMETEK uses a proprietary computer program for this task).

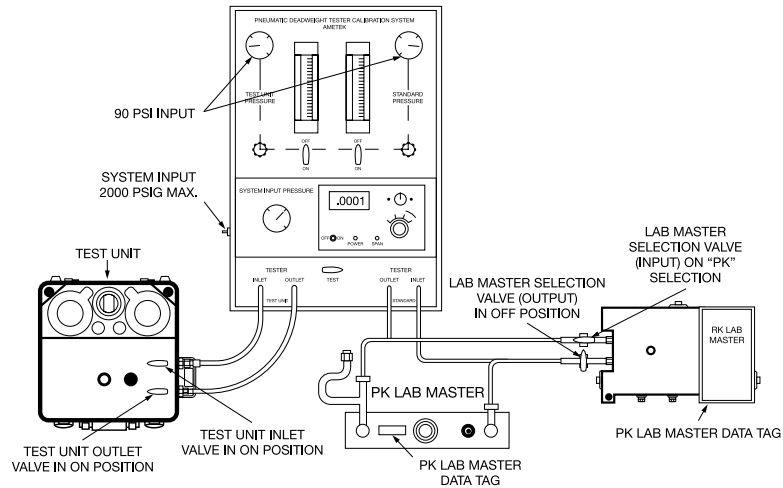

Figure 3-2
Test Equipment for a Pneumatic Floating Ball Deadweight Pressure Calibration Laboratory

3.2.2 Pneumatic Floating Ball Deadweight Testers

The equipment, as illustrated on Figure 3-2, consists of an AMETEK Pneumatic Tester Calibration System, a master floating ball pneumatic tester, with a known effective area, of the identical design (Model PK or RK) as the tester being tested, master weights with known mass and test weights with known mass. The calibration system incorporates a cross-over valve, a digital readout differential pressure meter and input flow meters for both the test and master testers.

The procedure for calibrating the floating ball testers is as follows:

1. The ball, nozzle and nozzle body of the floating ball tester with unknown effective area are thoroughly cleaned (See Section 4. for the recommended cleaning procedure).
2. The tester is leveled and the bulls-eye level is adjusted accordingly (See Section 4. for the recommended procedure for leveling).
3. Input pressure is applied to both testers with the cross-over valve in the open position.
4. Weights are added to both the test unit and the master unit for the initial test point.

5. The cross-over valve is closed. The pressure differential between the test and the master tester is displayed on the differential pressure meter display.
6. The steps 3 and 4 are repeated for each required test pressure.
7. The effective area of the unknown ball and nozzle is determined using the equation in paragraph 2.4 (AMETEK uses a proprietary computer program for this task).

3.3 Frequency of Calibration

3.3.1 Frequency of Recertification and Recalibration of Piston & Cylinder Type Deadweight Testers

The precision piston and cylinder assembly, the operating heart of the hydraulic deadweight tester, is a device which given proper care and use has a long service life. M&G has many customers who have pistons and cylinders in use for over 10 years.

Recertification of a deadweight tester is a precautionary measure required by each user to assure that each device has not worn sufficiently to produce inaccurate pressures. As discussed in paragraphs 2.6.1 and 3.3, many different

pressure between the output on the master and factors can contribute to wear of the piston and cylinder. No specific time period for recertification is appropriate for each application. If the device is exposed to heavy usage and factors that contribute to wear such as dirty instruments being tested, frequent calibration is appropriate. Infrequently used instruments used only in laboratory conditions need not be calibrated frequently.

The United States National Institute of Technology has suggested that⁷"For piston gages for use as plant or laboratory standards (Accuracy within 0.1%) when the gage is connected to a leak tight system and the piston is set into rotation that the piston should fall slowly as a result of the leak between it and the cylinder. At maximum pressure, the fall rate of a good instrument should be less than 0.1 inch per minute. We regard this as the most important single index of quality".

Confirming the NIST findings, AMETEK has found that the leakage rate of the piston and cylinder is the best measure of wear. This is an easy test to perform on AMETEK testers:

1. Load the tester with 100# of weights.
2. Pump piston to the top of the stroke.
3. Spin the weights and measure the time until the weights descend to the bottom of the stroke.
4. If the time, thus the leak rate, increases significantly ($\pm 5\%$) wear is indicated and the tester should be recalibrated.

AMETEK suggests that for users with unknown history of usage with deadweight testers consider conducting leakage tests monthly and have the testers recertified annually. This annual recertification should include the actual performance data. As the user accumulates a history of usage and wear, the recertification interval can be adjusted accordingly.

3.3.2 Frequency of Recertification of Floating Ball Type Pneumatic Type deadweight Testers

Frequency of recertification of a pneumatic deadweight tester is a precautionary measure undertaken by each user to assure that the device is functioning accurately and has not worn in such a way as to produce inaccurate pressure. As discussed in Section 4.5, many factors can contribute to malfunction and wear. No standard period of recertification is appropriate for every application. If the device is used for portable service in dirty or dusty environment, frequent recalibration is appropriate. Infrequently used instruments used only under laboratory conditions need not be calibrated as frequently.

AMETEK has found that the input flow rate to the tester for a specific output pressure is the best measure of the operation of the tester. A flow meter capable of reading flow in Standard cubic Feet per Hour is placed in the input nitrogen line prior to the tester. The tester is cycled through several output pressures within its pressure range and the input flow rate is recorded. This flow recording should be initiated when the tester is new or immediately after a recalibration is completed. If a flow rate for a given pressure changes significantly ($\pm 5\%$), wear or malfunction are indicated.

Formal recertification should be done at regular intervals by cross-floating the tester against a NIST Certified Master Tester in a pressure laboratory. AMETEK recommends that users with an unknown history of usage with ball type pneumatic testers initially consider conducting flow tests monthly and have the testers recertified annually. The annual test recertification should include performance data (Area, mass, correction factors, etc). As the user accumulates a history of usage and wear, the recertification cycle can be adjusted accordingly.

Chapter 4

AMETEK® Deadweight Testers

AMETEK produces an extensive line of both hydraulic and pneumatic deadweight testers and deadweight gauges for both laboratory and field portable applications. Within this chapter we will describe the unique features of the AMETEK instruments, the features of each tester, operating procedures and care of the testers.

4.1 Deadweight Testers and Deadweight Gauges

All deadweight testers and deadweight gauges are primary pressure standards. These instruments are one of only two instruments that can be used to generate pressure using the fundamental S.I. units. Pressure within both the deadweight tester and the deadweight gauge is generated using the fundamental expression:

$$\text{Pressure} = \frac{\text{Force}}{\text{Area}}$$

Deadweight testers incorporate a source for generating pressure, such as a hand pump. Instruments that are to be tested are attached to deadweight testers and the pump is used to pressurize both the instrument under test and the deadweight piston and cylinder.

Deadweight gauges, on the other hand, do not incorporate a pressure source. A deadweight gauge is attached to a source of pressure, such as a pressurized line, and is used to measure the pressure within the line very accurately.

4.2 Features of AMETEK Hydraulic Piston & Cylinder Deadweight Testers

The AMETEK hydraulic deadweight testers are shown schematically on Figure 4-1. These instruments consist of a re-entrant type piston and cylinder mounted in a pressure containing column assembly, a weight carrier suspended on the piston, weights, a pump to supply pressure and a vernier assembly.

AMETEK hydraulic deadweight testers and deadweight gauges incorporate many features that are designed to improve the performance and safety of these instruments:

Dual Volume Hand Pump

The lever action hand pump that is supplied with both the Type R & T Hydraulic Deadweight Testers incorporates a dual volume control valve. This permits the pump to deliver a high volume to rapidly fill systems and build pressure. The low volume permits easy pumping at high pressures and a more gradual approach to the point of pressure calibration.

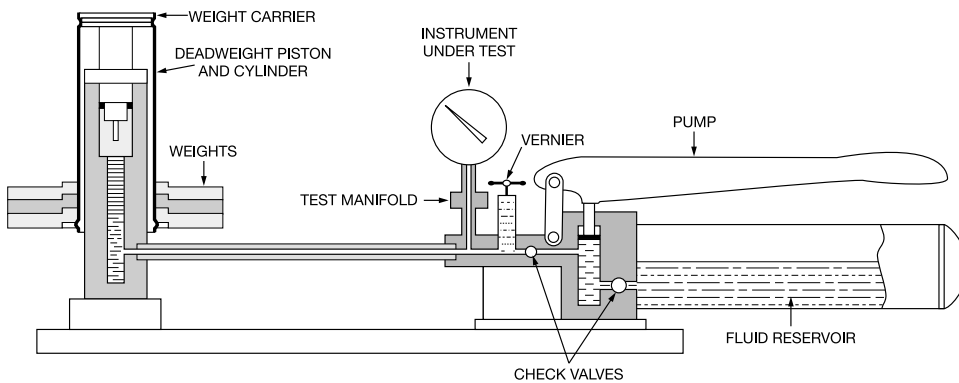

Figure 4-1
Deadweight Tester Schematic

Overhung Weight Carriers

The weights are suspended from a weight tube which is suspended from the piston assembly. As shown on Figure 4-2, this design lowers the center of gravity of the suspended weights and reduces side thrust and friction on the measuring piston and cylinder assembly thus improving the measurement accuracy.

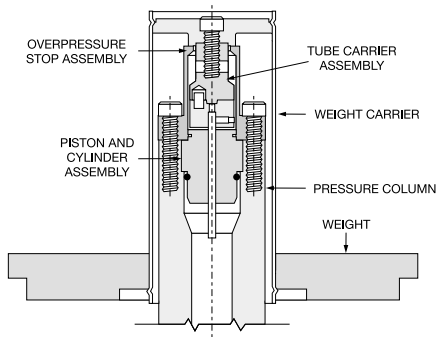

Figure 4-2
Piston & Cylinder Mounting Assembly

Re-entrant Type Piston & Cylinder Assembly

This design of piston and cylinder, as described in Section 2.1.2, has a reduced clearance between the piston and cylinder at higher pressures. The advantage of this design is to reduce the rate of fluid leakage at high pressures, thus increasing the time available for the technician to calibrate instruments prior to pumping to restore fluid loss.

Enclosed Piston & Cylinder Assembly

The piston and cylinder assembly is enclosed in a unique column design, see Figure 4-2. The weight carrier is floated on the piston assembly to prevent side thrust. These features prevent accidental damage to the piston assembly.

Positive Over-pressure Protection of the Measuring Piston Assembly

The vertical movement of the measuring piston assembly is restricted by a positive stop as illustrated on Figure 4-2. This positive stop will prevent the piston from damage caused by accidental removal of the weights when pressurized. These stops are rated at the maximum tester pressure.

Interchangeable Piston & Cylinder Assemblies

The column assemblies will accept several different size piston & cylinder assemblies as illustrated on Figure 4-3. The Type T or R column accepts piston and cylinder assemblies with cross section areas of 0.1, 0.05, 0.02 and 0.01 square inch. The Type HL column accepts piston and cylinders with 0.1 and 0.02 square inch areas. With the use of a single weight set, this feature increases the test pressure range capability of the testers.

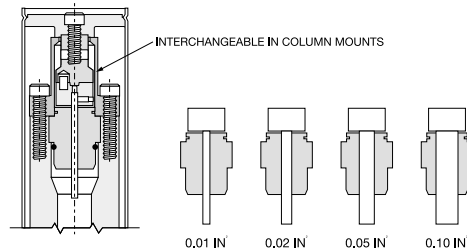

Figure 4-3
Interchangeable
Piston & Cylinder Assemblies

Pressure Vernier

An auxiliary screw type piston on the Type T & R deadweight testers permits fine adjustment of pump pressure. The pump in the Type HL deadweight testers is a screw type piston pump which permits fine adjustment.

Accuracy

The standard accuracy of the Type T, R & HL deadweight testers is $\pm 0.1\%$ of the indicated pressures at nominal readings. An optional accuracy of $\pm 0.025\%$ of the indicated reading is available on the T & R testers.

Certification of Accuracy and Traceability

A certification of accuracy and traceability to NIST is included with each deadweight tester. An optional certification of accuracy with area, mass, intrinsic correction factors and pressures is provided with the optional $\pm 0.025\%$ accuracy.

Weight Materials

The weights for all AMETEK deadweight testers are manufactured of non magnetic materials to prevent inaccuracy. The standard model T,R,10 and HL weights are manufactured of a hard non-magnetic zinc alloy. Optional weights for the Model T & R testers are manufactured from forged brass conforming to the material requirements of NIST Class Q.

Interchangeable Weights

The weights for standard accuracy (0.1%) dead-weight testers are interchangeable and lost or damaged weights may be replaced.

Test Fluid

The test fluid for the Type T is distilled water. The test fluid for the Types R ,10 and HL is AAA tester oil.

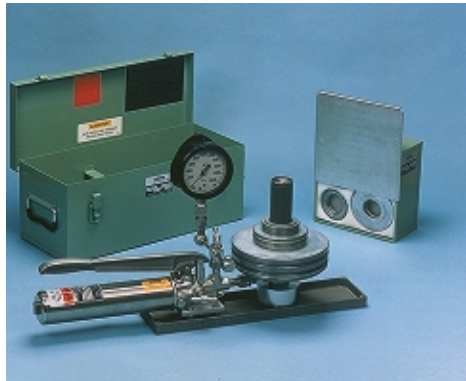

Figure 4-4
Type T & R Hydraulic Deadweight Tester

4.2.1 AMETEK Type T & R Hydraulic Deadweight Testers

The AMETEK Type T & R are pictured on Figure 4-4. These are high accuracy pressure standards designed for both laboratory or portable use. Specifications and features of these testers are as follows:

Pressure Range:

Type T- 10 to 15000 PSI (0.7 to 1034.3 bar)

Type R- 10 to 10000 PSI (0.7 to 689.5 bar)

Pressure Increments:

High range 50 PSI (3.5 bar)

Low range 5 PSI (0.4 bar)

Standard Models:

Type T- 11 English, 6 metric

Type R- 11 English, 6 metric

Accuracy:

$\pm 0.1\%$ of indicated reading

$\pm 0.025\%$ of indicated reading (optional)

Features:

- Dual Volume Hand Pump
- Overhung Weight carriers
- Re-entrant type Piston and Cylinder Assemblies
- Enclosed Piston and Cylinder Assembly
- Positive Over-pressure Protection of the Piston Assembly
- Interchangeable Piston & Cylinder Assemblies
- Interchangeable weights on standard accuracy testers
- Pressure Vernier
- Test Fluid- Type T, Distilled Water or AAA oil; Type R, AAA oil

4.2.2 AMETEK Type 10 Hydraulic Deadweight Tester

The AMETEK Type 10 hydraulic deadweight tester is illustrated on Figure 4-5. This tester is designed for both laboratory and portable applications. Specifications and features are as follows:

Dual Pressure Range:
5 to 2000 and 25 to 10000 PSI
(0.4 to 138 and 1.7 to 689.5 bar)

Pressure Increments:
High range 25 PSI (1.7 bar)
Low range 5 PSI (0.4 bar)

Standard Models:
5 English, 10 metric

Accuracy:
±0.1% of indicated reading

Features

- Interchangeable coaxial design piston and cylinder assemblies for rapid changeover.
- Interchangeable weights
- Single volume pump
- Simple Piston and Cylinder assembly
- Pressure Vernier
- Test Fluid, AAA oil



Figure 4-5
Type 10 Hydraulic Deadweight Tester

4.2.3 AMETEK Type HL Hydraulic Deadweight Testers

The AMETEK Type HL, Hydra Lite, hydraulic deadweight tester is illustrated on Figure 4-6. This tester incorporates a unique single case design for portable applications. The entire tester, including weights, is contained in a 9.0 x 9.0 x 10.0-inch (228.6 x 228.6 x 254.0 mm) case. Specifications and features are as follows:

Dual Pressure Range:
10 to 600 and 50 to 3000 PSI
(0.7 to 41.4 and 3.5 to 206.9 bar)

Pressure Increments:
High range 0.5 PSI
Low range 0.1 PSI

Standard Models:
9 English, 18 metric

Accuracy:
±0.1% of indicated reading

Features

- Screw type single piston pump with ratchet handle
- Interchangeable weights
- Tripod mountable for field use
- Overhung weight carriers
- Re-entrant type piston and cylinders
- Enclosed piston and cylinder assembly
- Positive over-pressure protection of the measuring pistons
- Test fluid, AAA oil



Figure 4-6
Type HL Hydraulic Deadweight Tester

4.2.4 AMETEK Dual Column Hydraulic Deadweight Testers

The AMETEK dual column hydraulic deadweight testers are illustrated on figure 4-7. These testers, which are manufactured in both Type T and Type R design, are designed for both laboratory or shop installation. Separate columns are provided for both the high and the low pressure piston and cylinder assemblies. Range changes are accomplished rapidly by actuating a crossover valve.

The features and specifications are identical to the Type T and Type R described in paragraph 4.2.1.

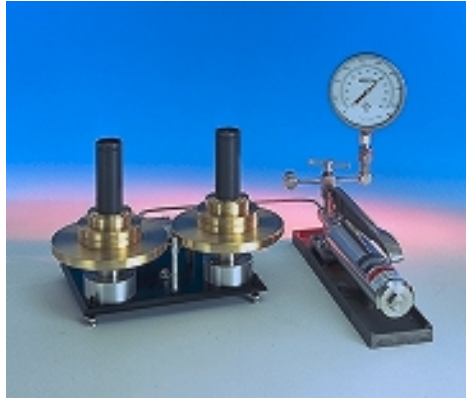

Figure 4-7
Dual Column Hydraulic Deadweight Testers

4.3 Features of AMETEK Hydraulic Piston & Cylinder Deadweight Gauges

A deadweight gauge is designed to be connected to a source of pressure, such as a feed water line in a steam power plant or a gas well head, and measure the pressure with a high degree of accuracy. In operation, after the tester is connected to the pressure source, weights are added onto the piston until the piston floats freely in mid stroke. The features of the deadweight gauges are identical to the comparable deadweight testers (Type T and Type HL) with the following additions:

- **Elastomer Membrane Fluid Separator**
An elastomer membrane is included to permit isolation of the piston and cylinder from the process fluid to permit operation with both contaminating or abrasive fluids and also to permit operation with pneumatic pressure.
- **Conversion Capability to a Deadweight tester**
The Type HLG may be converted to a deadweight tester with the addition of a conversion kit.

4.3.1 AMETEK Model HLG Deadweight Gauge

The AMETEK Model HLG deadweight gauge is shown on Figure 4-8. This instrument is designed as a portable instrument to take accurate pressure measurements under field conditions. The range and features are identical to the Type HL deadweight tester. This instrument can be upgraded to a Model HL deadweight tester by the addition of an AMETEK conversion kit (P/N T-535).



Figure 4-8
Model HLG Hydraulic Deadweight Gauge

4.4 Features of AMETEK Floating Ball Type Pneumatic Dead Weight Testers

The AMETEK pneumatic deadweight testers are self-regulating primary type pressure standards. An accurate calibrating pressure is produced by bringing into equilibrium the pneumatic pressure on the under-side of the ball with known effective area by weights of known mass on the top.

The ball type pneumatic deadweight tester is shown on the schematic diagram on Figure 4-9. In this type of construction a precision ceramic ball is floated within a tapered stainless steel nozzle. A flow regulator produces pressure under the ball, lifting it in the stainless steel nozzle until equilibrium is reached. At this point the ball is floating and the vented flow equals the fixed flow from the supply regulator. The pressure, which is also the output pressure, is proportional to the weight load. During operation the ball is centered by a dynamic film of air, eliminating physical contact between the ball and nozzle.

When weights are added or removed from the weight carrier, the ball rises and lowers, affecting the air flow. The regulator senses the change and adjusts the pressure under the ball to bring the system under equilibrium, changing the output pressure accordingly. This regulation of output pressure is automatic with changes in weight mass on the spherical piston (ball). When minimum supply pressures are maintained, the unit equilibrium is unaffected by variations in supply pressure.

AMETEK floating ball type pneumatic dead weight testers incorporate many features that are designed to improve the performance and safety of these instruments:

Floating Ball

In operation, the ball and weights float freely, supported only by a film of air which is virtually frictionless. This feature eliminates the necessity to rotate the weights during testing, thus freeing the technician to concentrate on the task of instrument calibration.

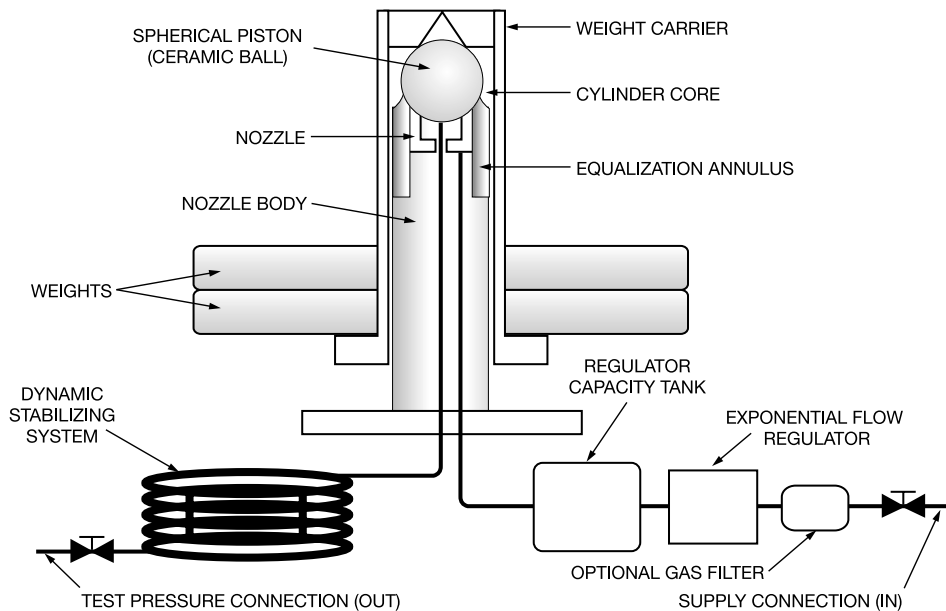

Figure 4-9
Schematic AMETEK Floating Ball Pneumatic Deadweight Testers

Self Regulating

The built-in flow regulator automatically adjusts the input air flow to maintain the ball and weights in a float position. The regulator also compensates for variations in pressure from the air supply. These features eliminate the necessity of the technician continually adjusting the supply during the test, thus permitting the technician to calibrate instruments more efficiently.

Rugged Ceramic Measuring Ball

The floating ball/piston is manufactured from aluminum oxide ceramic. This material has near diamond hardness. The ball, unlike steel and carbide pistons, can be dropped on hard surfaces without damage.

Quick Setup and Operation

Set up is completed by connecting two tubes and adding the appropriate weights. Operation is fast with no valves to adjust or regulation between set points. Pressure regulators are not required if the air supply is within the tester operational requirements.

Non Contaminating Test Fluid

The test fluid is nitrogen or instrument quality air complying to the ISA Standard S7.3. This fluid is non contaminating to virtually all processes, thus eliminating the need to clean instruments after calibration before use.

Tripod Mounting

The Models PK II and RK are designed for both laboratory and portable use. Both instruments incorporate built-in tripod mounts.

Closed Cover Operation

The Model PK II is designed to operate with the cover closed, thus eliminating the effects of wind during outside portable operation.

Ball Valves

All of the AMETEK floating ball testers incorporate multi-position ball valves for both the inlet and outlet valve connections. These valves afford quick, easy and trouble free operation.

Pre-fill Valve

A pre-fill valve connection is provided on the Model HK high pressure pneumatic testers. This valve permits the inlet pressure to bypass the

flow regulator to permit rapid filling of the system volume to be tested.

Accuracy

The standard accuracy of the Models PK II and RK is $\pm 0.05\%$ of the indicated pressures at nominal readings. Optional improved accuracies of $\pm 0.025\%$ and $\pm 0.015\%$ of the indicated pressures at nominal readings are available.

The standard accuracy of the Model HK tester is $\pm 0.025\%$ of the indicated pressure or ± 0.025 PSI whichever is greater.

Gravity

Standard weights for all of the ball type deadweight tester models are manufactured from non magnetic 300 series stainless steel. These weights can be calibrated to operate at International Standard Gravity (980.665 Gals.) or at the customers local gravity.

An economic model of the PK II tester is available with cast weights. These weights are calibrated to U.S. Mean Gravity (980.000 Gals.)

Certification of Accuracy and Traceability

A certification of accuracy and traceability to NIST is included with each floating ball type deadweight tester. An optional certification of accuracy with area, mass and intrinsic correction factors is available.

Weight Materials

The weights for all floating ball pneumatic deadweight testers are manufactured from non magnetic materials to prevent inaccuracy. The standard Model PK II, RK and HK weights are manufactured from 300 series stainless steel. The economic Model PK II uses cast weights manufactured of a hard nonmagnetic zinc alloy.

Interchangeable Weights

The cast weights for the economy Model PK II tester are interchangeable and lost or damaged weights may be replaced. AMETEK maintains a permanent file on all deadweight testers. All damaged or lost stainless steel weights can be replaced to the original mass when manufactured. In most instances, it is recommended that these testers be recalibrated prior to weight replacement.

4.4.1 AMETEK Model PK II Portable Deadweight Tester

The AMETEK Model PK II floating ball deadweight testers are pictured on 4-10. These instruments are high accuracy instruments designed for both laboratory and portable operation. This instrument is self contained in a rugged ABS plastic case designed for "Closed case operation", eliminating wind problems. The weights are individually stacked vertically in pockets in the case for ease of operation. Specifications and features of these testers are as follows:

Pressure Range:
4" H₂O to 30 PSI

Standard Models:
10 English, 5 metric

Accuracy:

±0.05% of indicated reading
±0.025% or ±0.015% of indicated reading (optional)

Features

- Floating Ball
- Self Regulating
- Rugged Ceramic Measuring Ball
- Quick Setup and Operation
- Non Contaminating Test Fluid
- Tripod Mount is Standard
- Closed Cover Operation
- Ball Valves for Inlet and Outlet
- Stainless Steel weights Calibrated to Local or International Standard Gravity
- Interchangeable Weights on Economical Model Tester



Figure 4-10
Model PK II Pneumatic Deadweight Tester

4.4.2 AMETEK Model RK Portable Floating Ball Deadweight Tester

The AMETEK Model RK floating ball deadweight testers are pictured on Figure 4-11. These instruments are high accuracy instruments designed for both laboratory and portable operation. This instrument is self contained in a cast metal base with an ABS plastic cover. It is self contained with weights for pressures to 50 PSI (3.5 bar), with additional cases to carry the remaining weights. The weights are stacked vertically in the cases for ease of operation. Specifications and features of these testers are as follows:

Pressure Range:

4" H₂O to 300 PSI

Accuracy:

±0.05, ±0.025% or ±0.015% of indicated reading

Repeatability:

±0.005% of output reading

Temperature Coefficient:

0.00167% output pressure per °C

Models

10 English, 15 metric

Features

- Floating Ball
- Self regulating
- Rugged Ceramic measuring ball
- Quick Setup and Operation
- Non Contaminating Test Fluid
- Tripod Mount is Standard
- Ball Valves for Inlet and Outlet
- Stainless Steel Weights



Figure 4-11

Model RK Pneumatic Deadweight Tester



Figure 4-12

Model HK Pneumatic Deadweight Tester

4.4.3 AMETEK Model HK High Pressure Floating Ball Deadweight Tester

The AMETEK Model HK floating ball pneumatic deadweight testers are pictured on Figure 4-12. These instruments are high accuracy instruments designed for laboratory operation. All instruments are supplied with stainless steel weights with a protective storage case. The tester itself is supplied with a laminated wood grained storage case. Specifications and features of these instruments are as follows:

Pressure Range:

Standard 10 to 1000 PSI (0.7 to 69 bar)
Optional 100 to 1500 PSI (6.9 to 103.4 bar)

Accuracy:

±0.025% of indicated reading

Repeatability:

±0.005% of Output Reading

Temperature Coefficient:

0.00167% output pressure per °C

Models

5 English, 3 metric

Features:

- Floating Ball
- Self Regulating
- Rugged Ceramic Measuring Ball

- Quick Setup and Operation
- Non Contaminating Test Fluid
- Ball Valves for Inlet and Outlet
- Pre-fill Valve
- Stainless Steel Weights Calibrated for Local International Standard Gravity

4.4.4 AMETEK Model PK II Medical Floating Ball Deadweight Tester

The AMETEK Model PK II Medical floating ball deadweight tester, shown on Figure 4-12, is a self regulating, portable, primary type pressure standard designed to provide an accurate pressure calibration standard for physiologic pressure ranges. Standard hospital wall oxygen outlets or therapeutic oxygen pressure regulators provide a convenient source of supply pressure. The instrument will also operate on compressed air or dry nitrogen. Specifications and features of these testers are as follows:

Pressure Range:
10 to 325 mm Hg

Accuracy:
 $\pm 0.05\%$, $\pm 0.025\%$ or $\pm 0.015\%$ of Indicated Reading

Repeatability:
 $\pm 0.005\%$ of indicated reading

Temperature Coefficient:
0.00167% of output pressure per °C

Features

- Floating Ball
- Self regulating
- Rugged Ceramic Measuring Ball
- Quick Setup and Operation
- Non Contaminating test fluid
- Closed Cover Operation
- Oxygen Swivel Valve and Hose on Inlet, 1/8" Male Luer Lock on Outlet
- Stainless Steel Weights Calibrated to Local or International Standard Gravity



Figure 4-12
Model PK II Medical
Pneumatic Deadweight Tester

4.5 Care of AMETEK Deadweight Testers

4.5.1 Care of AMETEK Piston & Cylinder Type Deadweight Testers

The United States National Institute of Standards and Technology has suggested that⁷ “For piston gages for use as plant or laboratory standards (Accuracy within 0.1%), the following points are pertinent to the instrument performance:

1. The weights should be non magnetic, solid, preferably of a hard, nonporous metal, such as brass or stainless steel. They should mesh accurately, and should have a smooth finish, preferably polished.
2. The piston should turn freely in the cylinder. When the weights are loaded on top of the piston and set into rotation, they should continue to rotate for several minutes. Some instruments have means for rotating or oscillating the piston. These devices should produce negligible longitudinal thrust.
3. When the gauge is connected to a leaktight system, and the piston is set into rotation, the piston should fall slowly as a result of the leak between it and the cylinder. At maximum pressure, the fall rate of a good instrument should be less than 0.1 inch per minute. We regard this as the most important single index of quality.
4. The structure should be such that the level of oil surrounding the piston is known at all positions of the piston, in order to correct for air buoyancy. The weight of oil displaced by the submerged portions of the piston, and the weight of air displaced by the rest of the piston and load, must be subtracted from the load. The pressure thus measured is that which obtains at the level of the oil surface. If the reference level of the gauge being calibrated is higher or lower than this level, corrections should be made for the head of oil, about 0.03 PSI (2 mbar) for each inch of difference in height.
5. Occasionally the direction of rotation will affect the pressure developed by the piston gauge. This has been attributed to helical tool marks on the piston or cylinder or guide bearing. Observations should be taken, at least occasionally, reversing the direction of rotation, but changing nothing else.
6. Erratic behavior has sometimes been observed if the weights are stacked off center. There may be fluctuation of pressure in synchronism with the rotation, or a change of pressure which depends on the speed of rotation or a change of pressure which depends on the speed of rotation, but not the direction. These problems are most severe in instruments with the weights stacked in a tall pile on top of the piston. A suspended, non rotating load may oscillate abnormally when the piston is rotated or oscillated at a particular speed. Such speeds should be avoided.”

AMETEK has found the following items to be important factors affecting performance and life of piston gauges⁸:

1. **FLUID CLEANLINESS**-Deadweight testers are closely fit devices with clearances of 1 or 2 millionths of an inch and finishes exceeding 1 micro inch. The principle source of fluid contamination is the interior of instruments being calibrated. When pressure is relieved, contaminants within the instrument being calibrated are exhausted into the deadweight tester. If instruments contain dirty fluid or particles, they should be flushed prior to testing. Individual users must consider the cleanliness of the instruments when establishing the frequency of changing the test fluid.

2. **FLUID LUBRICITY**-The test fluid creates a lubricating film between the closely fit piston and cylinder. The ability of the fluid to lubricate at high pressure is an important criteria in determining the wear rate of pistons and cylinders. A high pressure spindle type oil such as AMETEK AAA Tester Oil affords maximum protection. Other test fluids such as water which is used within the AMETEK Type T testers afford satisfactory operation but reduce service life slightly. Silicone oils must be avoided as they tend to crystallize at high pressures causing the piston and cylinder to seize.

3. **STORAGE TECHNIQUES**-The storage of the close fitting piston and cylinder assembly is important to continued service life. AMETEK has found that the piston and cylinder should be separated and individually coated with light oil during storage. After storage, both the piston and cylinder must be cleaned prior to use.

4. **INSTALLATION**-It is important to install the piston and cylinder so that the piston does not bind within the cylinder. The cover that secures the piston and cylinder within the AMETEK Type T & R testers contains eight cap screws. These screws should be tightened in a criss-cross pattern to minimize distortion. Frequent changes of the piston and cylinder should be avoided because of the attendant risk of damage. If the users task involves frequent calibration of instruments, the AMETEK Dual Column Assembly should be considered. In this device, the high and low pressure pistons are separately mounted and range changes are accomplished by adjusting the high pressure valves.

5. **CLEANING**- The most important care that can be given to a deadweight piston and cylinder assembly is cleaning. Cleaning is particularly important during the initial use of pistons and cylinders. Although efforts are made to clean all parts after manufacture, some abrasive particles remain within the pores of the material. After application of pressure, these particles are discharged. It is recommended that new pistons and cylinders be cleaned prior to each usage for the first month of operation. Monthly cleaning thereafter is satisfactory. AMETEK recommended cleaning procedures are included in paragraph 4.6.1.

4.5.2 Care of AMETEK Floating Ball Type Pneumatic Deadweight Testers

AMETEK has found the following items to be important factors affecting performance and life of the floating ball type pneumatic deadweight testers⁸.

1. **AIR CLEANLINESS**- The AMETEK floating ball deadweight tester contains several small diameter bores. Free passage of air within these bores is important for the correct operation of this device. The air used to operate the tester must be both clean and dry to preclude problems. M&G recommends the use of instrument quality air as defined by Instrument Society of America Specification ISA-S7.3 "Quality Standard for Instrument Quality Air".

2. **CLEANING**- Cleaning of the ball and nozzle is important prior to the use of the pneumatic deadweight tester. This cleaning is easily done by removing the tester nozzle and cleaning the ball, nozzle and nozzle body with a non residue solvent such as grain alcohol and a lint free cloth or paper. Tester weights should be cleaned periodically with alcohol and a lint free cloth or tissue paper.

3. **LEVELING**- For proper operation, the air stream exhausting around the ball should be equally distributed around the periphery of the ball and the weight carrier is not in any contact with the nozzle body. Each tester is equipped with a bullseye level which is pre set during manufacture. Proper level may be verified by either of the following methods:

A. The tester should be leveled and operated with only the weight carrier (4"H₂O or 10"H₂O) in place. The carrier should be carefully set into rotation. This rotation should continue for at least two (2) minutes. If the rotation stops prematurely, the level should be corrected.

B. The hand may be placed above the nozzle and feeling the direction of the exhaust gas. This stream should be approximately vertical when the tester is in operation. The weight carrier may be rotated to aid in the determination of the air stream direction.

It should be noted that once the tester is calibrated and the level is adjusted, the level should not be reset unless the accuracy of calibration is re-tested.

4. OPERATING TECHNIQUE- The pneumatic deadweight tester is designed as a self regulating device which produces an accurate pressure independent of operator technique. The operator must, however, exercise care during operation. The weight carrier is suspended from the ball on three prongs. Care should be taken not to drop the carrier or drop weights onto the carrier in such a way as to bend one or more prongs.

5. LEAKAGE- The accuracy of the pneumatic tester is seriously affected by leaks in the output or input connections and/or within the instrument being calibrated. Leaks within the output connection or instrument are easily determined by closing the tester output valve and determining whether the instrument under test shows pressure loss. Internal tester leaks are identified by placing an O-ring under the ball and closing the pressure inlet. Again, pressure loss shown on the instrument being calibrated indicates a leak.

6. TEST GAS- The pneumatic deadweight tester is calibrated for pressure accuracy with nitrogen gas. The use of gases with other density will affect the output pressure. The testers can be calibrated for some gas densities other than nitrogen on special order. Gases used with the tester must also be compatible with the materials used for construction. AMETEK can assist users, on request, to evaluate alternate gases.

4.6 Procedures for the Use of AMETEK Deadweight Testers

4.6.1 Procedures for Cleaning Hydraulic Pistons and Cylinders

Each piston and cylinder should be cleaned prior to use. If a piston and cylinder has been stored outside the tester, it should be recleaned prior to use. It is very important that new pistons and cylinders be cleaned repeatedly prior to use to remove all evidence of the abrasive particles used during manufacture. Periodic recleaning of piston and cylinders is necessary. A lack of sensitivity to small pressure changes is an indication that cleaning is necessary.

The suggested cleaning procedure for pistons and cylinders is as follows:

1. Carefully wipe off any visible dirt or foreign matter from the protruding part of the piston and slowly withdraw the piston from the cylinder. Do not use force, but be sure that all dirt is removed so that the piston will slip out easily.
2. Boil both the piston and cylinder for at least 15 minutes in distilled water. The cylinder bore should be wiped with a small wood handled wiper such as a cotton swab to remove all evidence of dirt. Wipe the piston dry and clean with a lint free tissue paper.
3. Rinse both the piston and cylinder in grain alcohol.
4. Wipe the cylinder bore and the piston again to remove any dirt or grit.
5. Pick up the piston by the piston cap and dip it into clean fluid to be used in the tester, then carefully insert the piston into the cylinder. If any feeling of roughness or what might be grit in the annulus area is suspected, disassemble and repeat the cleaning procedure.
6. At the same time, the deadweight column output post and tubing should be drained and flushed with a residue free solvent such as grain alcohol, then cleaned, dried and refilled using clean test fluid.

7. The piston and cylinder assembly then can be installed carefully in the mounting column.

CAUTION

Do not touch the piston and cylinder with the fingers or other soiled or contaminating surfaces after cleaning. Extremely minute particles may cause trouble in a closely fitted assembly.

4.6.2 Procedures for the Use of Hydraulic Deadweight Testers

The following procedure is typical of methods used to test pressure instruments using hydraulic deadweight pressure testers. The user is encouraged to modify these procedures to test critical instrument characteristics.

The step by step procedure is as follows¹³:

1. Remove the pressure instrument from service and blowdown (Vent to atmosphere to remove trapped pressure from the pressure side of the instrument).
2. Set up the deadweight tester and level the instrument.
3. Connect the pressure input of the pressure instrument to the pressure test port on the deadweight tester.
4. Put weights on the deadweight tester carrier equal to 90 to 100% of the range of the instrument being tested.
5. Build up pressure with the tester hand pump until the weights float freely. Rotate the weights 10 to 30 RPM. Check to be sure that no leaks are present.
6. If no leaks are present, proceed with the calibration. If leaks are apparent, they must be located and repaired before proceeding with the calibration.

7. Remove all pressure from the tester hand pump. Vent the high and low side of the pressure instrument to atmosphere. Adjust zero on the instrument.

8. Leave the low side of the instrument open to atmosphere, open the high side of the instrument to the deadweight tester.

9. Begin calibration by placing weights on the deadweight tester weight carrier equal to 25% of the range of the instrument being tested.

10. Build up pressure with the tester hand pump until the weights float freely. Rotate the weights 10 to 30 RPM. Allow the instrument to settle for one (1) minute. Tap case of the instrument. Record the reading.

11. Place additional weights on the deadweight tester to read points at 50%, 75% and 100% of the instrument range.

12. Close valve between the deadweight tester and the instrument being tested.

13. Remove weights from the deadweight tester to read 75% of the range of the instrument being tested.

14. Open the valve between the deadweight tester and the instrument being tested. Allow the deadweight tester weights to settle. Weights must be floating freely and rotating 10 to 30 RPM. Allow the tester to stabilize for one (1) minute. Tap case of the instrument. Record reading.

15. Repeat steps 12 through 14 to read points at 50% and 25% of the instrument range.

16. Remove all pressure from the instrument being tested. Recheck the zero on the instrument.

4.6.3 Procedures for the Use of Hydraulic Deadweight Gauges

Deadweight gauges are used to measure pressures contained within an external source with high precision. Deadweight gauges do not contain a pump or any self contained source of pressure.

It is important to emphasize that all tubing, fittings and chambers within the deadweight gauge be rated at pressures higher than any pressure source that may be attached to the gauge. deadweight testers should not be used as deadweight gauges unless so certified by the manufacturer.

The following procedure is typical of the methods used for hydrostatic testing on pipelines and well static pressure testing.

The step by step procedure is as follows¹³:

1. Set up the deadweight gauge and level the instrument.
2. Connect the pressure port on the device to be tested to the inlet port of the deadweight gauge. A shut off valve should be placed at the pressure port and at the inlet of the deadweight gauge. A separator may be connected between the pressure tap and the inlet of the deadweight gauge. Some deadweight gauges contain isolation devices to prevent contamination from coming into contact with the piston and cylinder (See 4.3.1 , Elastomer Membrane).
3. Shut the valve on the deadweight gauge inlet, open the valve on the pressure port. Check for leaks; if leaks are present they must be repaired before proceeding, if no leaks are present proceed with the test.
4. Place weights on the deadweight gauge equal to 100% of the pressure within the line or well to be tested.
5. Open the inlet valve to the deadweight gauge slowly. Rotate the weights 10 to 30 RPM.

6. Observe the direction of the float of the piston and cylinder. If the piston is falling, weight must be removed. If the piston is rising, weight must be added. Weights should be added or deleted until equilibrium within the mid one-third of the piston and cylinder float range is achieved.

7. Sufficient time must be allowed for pressure conditions to stabilize. The higher the pressure the longer the period required for the conditions to stabilize.

8. Close the valve on the pressure port on the device being tested. Open the deadweight gauge vent valve to relieve pressure. Close the input valve on the deadweight gauge.

9. Remove the weights on the deadweight gauge. Use the manufacturer's data to determine the measured pressure. For example:

Piston & Cylinder Area- 0.01 inches²
Weight of Piston/Cylinder Carrier Assembly - 0.5 lbs
Weights on Carrier: 2 - 10 lb
 1 - 5 lb
 3 - 1 lb
 4 - 0.1 lb

$$\begin{aligned} \text{Pressure} &= \frac{\text{Weight}}{\text{Area}} \\ &= \frac{28.9 \text{ lbs}}{0.01 \text{ inches}^2} \\ &= 2890 \text{ lbs/inch}^2 \text{ (PSI)} \end{aligned}$$

10. The pressure measured by a piston gauge loaded with a particular value of weights is proportional to the local value of gravity. Once the local value of gravity is known (See paragraph 1.4), the nominal values can be converted to actual values by the equation:

$$\text{Force} = \frac{M \times g_l}{g_s}$$

Where:

M = Mass
g_l = Local value of gravity in cm/sec²
g_s = 980.665 (International Standard Gravity)

Under standard conditions, the pounds weight is equal to the pounds mass.

Continuing the example:

Local Gravity = 979.628 Gals (cm/sec²)
 Calibrated Gravity of Deadweight Gauge Weights = 980.665 Gals.

$$P = 2890 \times \frac{979.628}{980.665}$$

$$P = 2886.944 \text{ lbs/inch}^2 \text{ (PSI)}$$

4.6.4 Procedures for the Use of Floating Ball Type Pneumatic Deadweight Testers

A suggested step by step procedure to be used when calibrating a flow measuring instrument (Meter) with a PK tester is as follows¹⁴:

1. Remove meter from service and blowdown.
 2. Level PK and connect gas supply (30-35 PSIG) to inlet of the PK. PK should be close to meter to eliminate long tubing line on outlet. (Be sure skirt of the weight table is not dragging on the nozzle body.)
 3. Connect the PK outlet to the high side of the meter. vent the low side of the meter to atmosphere. Turn on the supply gas to the PK and open the outlet valve. provide filtered gas, free of liquids.
 4. Put weight equal to above 90% to 100% of the meter range of the PK and allow the pen to travel to a full stop on the chart (At least one minute).
 5. Close the outlet of the PK and observe the reading on the chart for about two or more minutes.
 6. If no leaks are present, proceed with the calibration. If leaks are present they must be located and repaired before proceeding with the calibration.
 7. With the PK outlet valve closed, vent the high and low side of the meter to atmosphere and adjust the zero on the chart.
 8. Leave the low side of the meter open to atmosphere, connect the high side to the PK.
 9. Begin meter calibration by placing the table and the necessary weights on the PK to read about 6" on a 50" meter (12" on a 100" Meter). Allow meter and PK to settle in for at least one full minute minimum time before pulling point on the chart.
- (Note: Use weights which allow reading to fall on the narrow line of the calibrating chart)
10. Place additional weights in increments of 10" on table to read points at 16", 26" and 46" on a 50"

meter (32", 52", 72" and 92" on a 100" meter, etc). Care should be taken when placing weights on the table to see that all points are reached with the meter travel in the up direction, in other words do not overshoot the points. Again, wait a minimum of one full minute before pulling any points.

13. Check down points at 42", 32", 22" and 12" on a 50" meter (84", 64", 44", and 24" on a 100" etc.). Care should be taken to remove weights in the proper manner so that all down points are reached from the downward travel of the meter. This is important as it will tell if there are binds in the meter.

14. Recheck zero of the meter.

Chapter 5

Manometers

Principle of Operation

Manometers derive pressure by the combination of a height differential of a liquid column and the density of the fluid within the liquid column. The U type manometer, which is considered as a primary pressure standard, derives pressure utilizing the following equation:

$$P = P_2 - P_1 = h_w \rho g$$

Where:

- P = Differential pressure
- P_1 = Pressure applied to the low pressure connection
- P_2 = Pressure applied to the high pressure connection
- h_w = is the height differential of the liquid columns between the two legs of the manometer
- ρ = mass density of the fluid within the columns
- g = acceleration of gravity

5.1 Types of Manometers

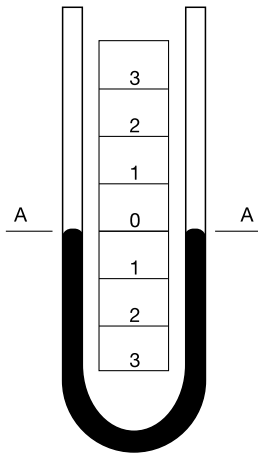

Figure 5-1
U-Tube Manometer Zero Pressure

5.1.1 U Tube Manometers

"The principle of operation of the U type manometer is shown on Figure 5-1. It is simply a glass tube bent to form the letter U and partially filled with some liquid. With both legs of the instrument open to atmosphere or subjected to the same pressure, Figure 5-1, the liquid maintains exactly the same level or zero reference. As illustrated on Figure 5-2, if a pressure is applied to the left side of the instrument, the fluid recedes in the left leg and raises in the right leg. The fluid moves until the unit weight of the fluid as indicated by "H" exactly balances the pressure. This is known as hydrostatic balance. The height of fluid from one surface to the other is the actual height of fluid opposing the pressure.

The pressure is always the height of fluid from one surface to the other regardless of the shape or size of the tubes, as illustrated in Figure 5-3. The left hand manometer has a uniform tube, the center one has an enlarged leg and the right one has an irregular leg. Manometers at the top are open to atmosphere on both legs so the indicating fluid level in both legs is the same. Imposing an identical pressure on the left leg of each manometer, as shown on Figure 5-4, causes the fluid level in each manometer to change. Because of the variations in volume of the manometer legs, the distances moved by the fluid columns are different. However, "H" the total distance between the fluid levels, remains identical in the three manometers"¹⁵.

5.1.2 Inclined Tube Manometers

"Many applications require accurate measurements of low pressure such as drafts and very low differentials. To better handle these applications, the manometer is arranged with the indicating tube inclined, as in Figure 5-5, providing for better resolution. This arrangement can allow 12" of scale length to represent 1" of vertical height. With scale subdivisions, a pressure of 0.00036 PSI (1/100 inch of water) can be read"¹⁵.

5.1.3 Well Type Manometers

The well type manometer is illustrated on Figure 5-6. In this design, the pressure is applied to a fluid well attached to a single indicating tube. As the fluid moves down in the well, the fluid displaced into the smaller indicating leg of the manometer. This permits direct reading on a single scale.

The well type manometer utilizes the principle of volume balance wherein the fluid displaced from the well is equal to the added fluid in the smaller indicating column. The well area and the internal diameter of the indicating type must be carefully

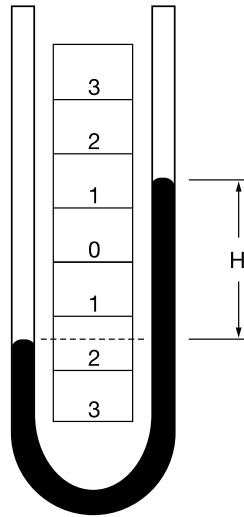

Figure 5-2
U-Tube Manometer Pressure Applied

controlled to insure the accuracy of the instrument.

The well type manometer does not fulfill the requirements of a primary standard as described in paragraph 1.5 and can be considered as one form of a secondary standard.

5.2 Intrinsic Correction Factors

5.2.1 Fluid Density Correction

Manometers indicate the correct pressure at only one temperature. This is because the indicating fluid density changes with temperature. If water is the indicating fluid, an inch scale indicates one inch of water at 4°C only. On the same scale mercury indicates one inch of mercury at 0°C only. If a reading using water or mercury is taken at 20°C then the reading is not an accurate reading. The error introduced is about 0.4% of reading for mercury and about 0.2% of reading for water. Since manometers are used at temperatures above and below the standard temperature, corrections are needed. A simple way for correcting for density changes is to ratio the densities.

$$\text{(Standard)} \rho_o g h_o = \text{(Ambient)} \rho_t g h_t$$

$$h_o = \frac{\rho_t}{\rho_o} \times h_t$$

Where:

h_o = Corrected height of the indicating fluid to standard temperature

h_t = Height of the indicating fluid at the temperature when read

ρ_o = Density of the indicating fluid at standard temperature

ρ_t = Density of the indicating fluid when read

Using this method is very accurate, when density/temperature relations are known. Data is readily available for water and mercury.

Density (g/cm³) as a function of temperature (°C) for mercury:

$$= 13.556786 [1 - 0.0001818 (T - 15.5556)]$$

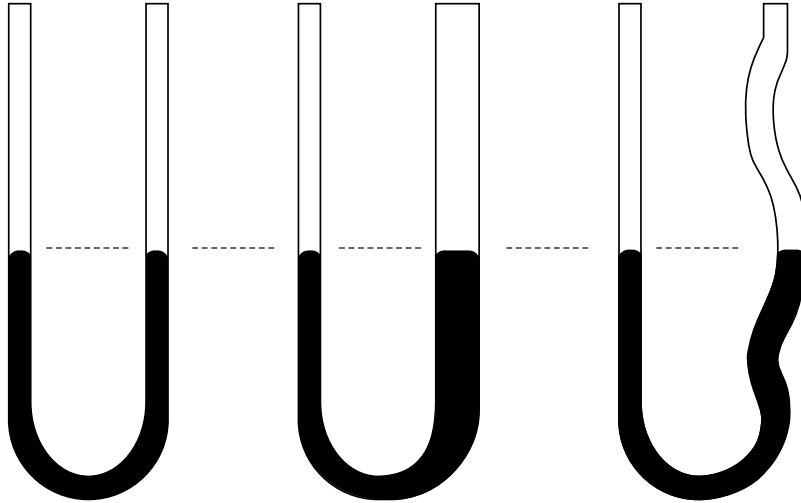

Figure 5-3
U-Tube Manometers Non-uniform Tubes, No Pressure

Density (g/cm³) as a function of temperature for water:

$$= 0.9998395639 + 6.798299989 \times 10^{-5} (T) - 9.10602556 \times 10^{-6} (T^2) + 1.005272999 \times 10^{-7} (T^3) - 1.126713526 \times 10^{-9} (T^4) + 6.591795606 \times 10^{-12} (T^5)$$

For other fluids, manometer scales and fluid densities may be formulated to read inches of water or mercury at a set temperature. The manometer still only reads correct at one temperature, and for precise work the temperature corrections cannot be overlooked.¹⁵

5.2.2 Gravity Correction

The need for gravity corrections arises because gravity at the location of the instrument governs the weight of the liquid column. Like the temperature correction, gravity correction is a ratio.

$$\text{(Standard)} \rho_o g_o h_o = \text{(Ambient)} \rho_i g_i h_i$$

$$h_i = \frac{\rho_o g_o}{\rho_i g_i} \times h_o$$

Where:

- g_o = International Standard Gravity(980.665 Gals.)
- g_i = Gravity at the instrument's location (In Gals.)

A 10° change in latitude at sea level will introduce approximately 0.1% error in reading. At the Equator (0° Latitude) the error is approximately 0.25%. An increase in elevation of 5000 feet (1524 m) will introduce an error of approximately 0.05%.

For precise work you must have the value of the gravity measured at the instrument location. Gravity values have been determined by the U.S. Coast and Geodetic Survey at many points in the United States. Using these values, the U.S. Geodetic Survey may interpolate and obtain a gravity value sufficient for most work. To obtain a gravity report, the instruments latitude, longitude and elevation are needed. Similar agencies are available in countries outside the United States. Contact local authorities for the agency and procedures to determine local gravity.

Where a high degree of accuracy is not necessary and values of local gravity have not been determined, calculations for differences in local gravity can be obtained. Gravity at a known latitude is:

$$G_x = 980.616 [1 - 0.0026373 \cos(2x) + 0.0000059 \cos^2(2x)]$$

Where:

- G_x = gravity value at latitude x, sea level (cm/sec²)
- x = latitude (degrees)

The relationship for inland values of gravity at elevations above sea level is:

$$G_i = G_x - 0.000094H + 0.00003408(H - H_1)(\text{cm/sec}^2)$$

Where:

- H = Elevation (feet) above mean sea level
- H_1 = Average elevation (feet) of the general terrain within a radius of 100 miles of the point¹⁵

5.2.3 Pressure Medium Head Correction

Commonly, a differential pressure is measured by the height of the fluid column. Actually the differential pressure, measured by the indicating fluid height, is the difference between the density of the fluid column and the density of equal height of the pressure medium.

The relationship is:

$$\rho_o g_o h_o + \rho_{pm} g_i h_i = \rho_i g_i h_i$$

$$h_o = \frac{g_i (\rho_i - \rho_{pm})}{g_o \rho_o} \times h_i$$

Where:

ρ_{pm} = density of the pressure medium

The significance of the pressure medium correction effect on the manometer reading varies with the indicating fluid and pressure medium. Whether this correction is necessary depends upon the user's accuracy requirements. The most common pressure medium is air. Not correcting for air over water yields an error of 0.12% (using the

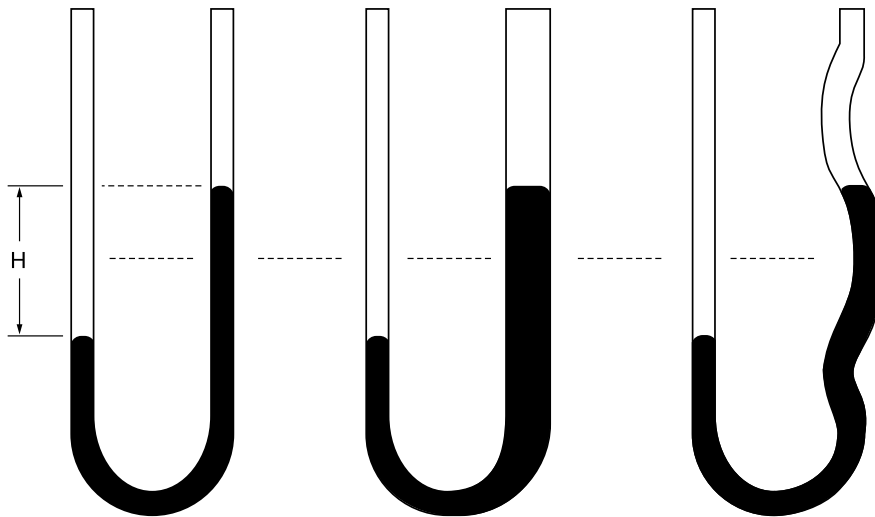

Figure 5-4
U-Tube Manometers Non-uniform Tubes, Pressure Applied

density of air as 0.0012 g/cm³). In precise work, air density can be determined exactly knowing the temperature, pressure and relative humidity of the air. The correction for air over mercury is extremely small (0.008% error) and therefore may usually be ignored. Another application, often used in flow applications, is water over mercury. The pressure medium correction in this situation is mandatory. An error of 7.4% is introduced if the correction is not applied. In many instances manometer scales can be designed with this correction built-in.

5.2.4 Scale Corrections

“Another factor governing manometer’s accuracy is the scale. As with indicating fluids, temperature changes affect the scale. At higher temperatures the scale will expand and graduations will be further apart. The opposite effect will occur at lower temperatures. All Meriam scales are fabricated at a temperature of 22°C (71.6°F). A 10°C shift in temperature from that temperature will induce an error in the reading of about 0.023% in an aluminum scale. All Meriam scales are made of aluminum.

$$h_o = h_t [1 + \alpha(T - T_o)]$$

Where:

- α = Coefficient of linear expansion for the scale material (0.0000232/°C for aluminum)
- T = the temperature when the manometer was read
- T_o = temperature when the scale was manufactured

5.2.5 Compressibility, Absorbed Gases and Capillary Considerations

Compressibility of indicating fluids is negligible except in a few applications. For compressibility to have an effect, the manometer must be used in measuring high differential pressures. At high differential pressures the fluid shrinkage (Increase in density) may begin to be resolvable on the manometer. At 250 PSI the density of water changes approximately 0.1%. Depending upon accuracy requirements compressibility may or may not be critical. The relationship between pressure and density of water is as follows:

$$\rho = 0.00000364 p + 0.9999898956$$

Where:

- ρ = density of water(g/cm³) at 4°C and pressure p
- p = pressure in PSIA

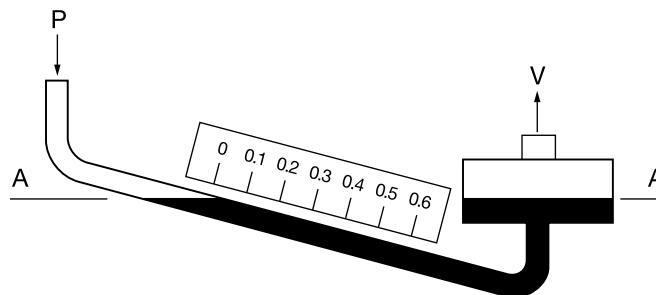

Figure 5-5
Inclined Tube Manometer

Since the need to correct is very rare, other indicating fluid's compressibilities have not been determined. Mercury's compressibility is negligible.

Absorbed gases are those gases found dissolved in a liquid. The presence of dissolved gases decreases the density of the liquid. Air is a commonly dissolved gas that is absorbed by most manometer fluids. The density error of water fully saturated with air is 0.00004% at 20°C. The effect is variable and requires consideration for each gas in contact with a particular fluid. Mercury is one exception in which absorbed gases are not found. This makes mercury an excellent manometer fluid in vacuum and absolute pressure applications.

Capillary effects occur due to the surface tension or wetting characteristics between the liquid and the glass tube. As a result of surface tension, most fluids form a convex meniscus. Mercury is the only fluid that does not wet the glass, and consequently forms a concave meniscus. For consistent results, you must always observe the fluid meniscus in the same way, whether convex or concave. To help reduce the effects of surface tension, manometers should be designed with large bore tubes. This flattens the meniscus, making it easier to read. A large bore tube also helps fluid drainage. The larger the bore the smaller the time lag while drainage occurs. Another controlling factor is the accumulation of corrosion and dirt on the liquid surface. The presence of foreign material changes the shape of the meniscus. With mercury, it helps to tap or vibrate the tube to reduce error in the readings. A final note to capillary effects is the addition of a wetting agent to the manometer fluid. Adding the wetting agent helps in obtaining a symmetrical meniscus.¹⁵

5.2.6 Parallax (Readability)

In order to achieve consistent results, the level of the meniscus on a manometer must be read with the eyes level to the meniscus. Placing the eyes level with the meniscus eliminates reading distortions caused by angle of reading, parallax, etc. If a mirror back is available, it will aid in placing the operators eyes in the proper position before taking a reading.

To duplicate the factory calibration procedure, read the lowest indicated liquid level as measured by the hairline at which the original zero was set.

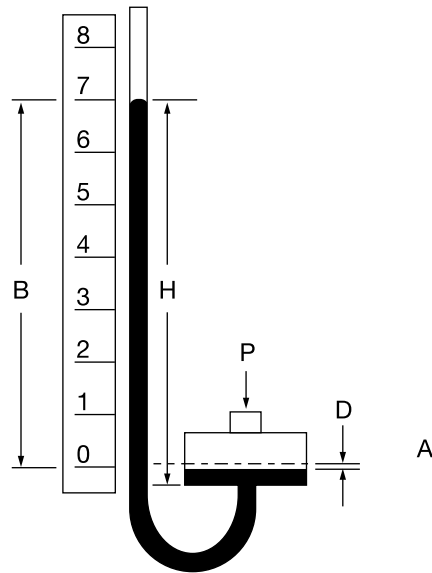

Figure 5-6
Well-type Manometer

Chapter 6

Secondary Comparison Pressure Standards

A secondary comparison pressure standard is any device that measures pressure which does not meet the criteria of a primary pressure standard. Secondary pressure standards therefore comprise both mechanical and electronic instruments with varying rates of measurement accuracy.

In general, secondary pressure standards have the following advantages in comparison to primary pressure standards:

1. Faster and easier to use
2. Usually no measurement corrections
3. Non-incremental measurements
4. Generally less expensive

In general, secondary pressure standards have the following disadvantages in comparison to primary pressure standards:

1. Must be periodically recalibrated by a primary pressure standard traceable to national standards
2. Pressure measurements cannot be reduced to measurements of mass, length or temperature

6.1 Types of Secondary Pressure Standards

6.1.1 Mechanical Pressure Gauges

The most commonly used secondary pressure standard is the mechanical pressure gauge. This instrument utilizes a hollow tube (Bourdon) that is formed into the shape of a C, a spiral or a helix. When pressure is applied within the tube, the tube tends to straighten out. This movement is transferred to a display pointer either through a gear rack and pinion mechanism or a direct drive.

The measurement accuracy of mechanical pressure gauges varies generally from 3% full scale to 0.10% full scale. The higher accuracy gauges are known as "Test gauges". The hollow tubes are generally manufactured from nonferrous materials such as beryllium copper, Monel, stainless

steel and Inconel "C". Other mechanical pressure gauges use diaphragms and capsules to expand with the applied pressure.

The Bourdon tube can also be constructed from a stable material such as quartz to achieve higher levels of measurement accuracy. Accuracies will vary with the manufacturer, but accuracies as high as 0.015% Full Scale are available.

6.1.2 Electronic Pressure Gauges

The electronic pressure standards comprise a large, divergent group of instruments with widely varying features and accuracy. Each of these instruments incorporates a pressure transducer, the function of which is to convert an input pressure signal to an electronic signal such as a resistance, voltage, current etc. The most common transducers incorporate an electronic strain gauge and a Wheatstone bridge generally located on a silicon chip. Other transducers incorporate piezo electric, vibrating wire or cylinders and other technologies.

The advantages of these instruments is that they display the pressure on easily read digital displays, are easy to use and are generally small, light in weight and portable. On the negative side, the secondary standards are generally not as accurate as primary standards and the accuracy is seriously affected by temperature variations. In most cases, the overall accuracy of the instrument is divided into several elements such as:

1. Accuracy, % Full Scale or % Indicated Reading
2. Precision, Repeatability, Hysteresis
3. Temperature Effect
4. Resolution

It is important when selecting a secondary pressure standard, therefore, to consider first the application task to be performed and then to evaluate the overall accuracy capabilities of each instrument.

6.2 Overall Application Accuracy

Many different elements must be combined to establish the overall application accuracy of an instrument when performing a specific test. These elements include the accuracy measurement, repeatability, hysteresis, linearity, temperature affect, resolution and laboratory uncertainty. Each of these elements is described within the following paragraphs.

6.2.1 Application Task

When evaluating the overall accuracy of an instrument, the first item that must be considered is the application or task for which the pressure standard will be used. Elements that should be considered are the minimum and maximum pressures to be measured and the minimum and maximum ambient temperatures within which the instrument will be used.

For purposes of illustration we have selected an application where the customer wishes to measure pressure over a range of 4" H₂O (20°C) to 200" H₂O with ambient temperature variations from 20° to 110°F (-7° to 43°C).

6.2.2 Accuracy Measurement

The measurement accuracy of instruments is generally expressed as "Per Cent of Full Scale"

or "Percent of Indicated Reading". As illustrated on Figure 6-1 if the accuracy of a 200 inch of water column capacity instrument is stated as $\pm 0.05\%$ full scale, the guaranteed accuracy is ± 0.1 inch of water column throughout the operating range. If the instrument is used at 10 inches of water, the accuracy of measurement is 1%. If on the other hand the accuracy of the same 200 inch of water column instrument is stated as $\pm 0.05\%$ indicated reading, the accuracy at 200 inches of water column would still be ± 0.1 inch of water but the accuracy at 10 inch of water column would be ± 0.005 inch of water column.

As an example of this calculation, consider an electronic pressure gauge (A) with a specified range from 0 to 280" H₂O, a stated accuracy of 0.1% full scale plus 1 Least Significant Digit. For the application of 4" H₂O to 200" H₂O, the accuracy portion of the overall application accuracy at the 4" and 25" H₂O test points would be:

Specified error:

$$280" \text{ H}_2\text{O (Full Scale)} \times 0.1\% = 0.28" \text{ H}_2\text{O}$$

$$\text{Least Significant Digit} = 0.1" \text{ H}_2\text{O}$$

$$\text{Total} = 0.28 + 0.1 = 0.38" \text{ H}_2\text{O}$$

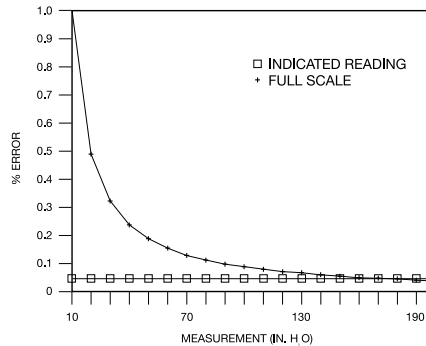

Figure 6-1
Accuracy % Full Scale versus % Indicated Reading

Application error @ 4" H₂O:

$$0.38" \text{ H}_2\text{O} / 4 \times 100 = 9.5 \%$$

Application error @ 25" H₂O:

$$0.38" \text{ H}_2\text{O} / 25 \times 100 = 1.52 \%$$

As a further example of an electronic pressure gauge, consider an instrument (B) with an operating range of 0 to 5 PSIG, a stated accuracy of $\pm 0.03\%$ full scale plus 0.07% of the indicated reading plus 1 Least Significant Digit. The accuracy portion at the 4" and 25" H₂O test points would be:

Specified error:

$$5 \text{ PSI} \times 27.72" \text{ H}_2\text{O}/\text{PSI} \times 0.03\% = 0.04158" \text{ H}_2\text{O}$$

$$0.07\% \text{ Indicated Reading} \times 4" \text{ H}_2\text{O} = 0.0028" \text{ H}_2\text{O}$$

or

$$0.07\% \text{ indicated Reading} \times 25" \text{ H}_2\text{O} = 0.0175" \text{ H}_2\text{O}$$

Least Significant Digit = 0.001" H₂O

Total @ 4" H₂O = 0.04538" H₂O

Total @ 25" H₂O = 0.06008" H₂O

Application error @ 4" H₂O:

$$0.04538" \text{ H}_2\text{O} / 4 \times 100 = 1.1345 \%$$

Application error @ 25" H₂O:

$$0.06008" \text{ H}_2\text{O} / 25 \times 100 = 0.24032 \%$$

Consider as a further example a deadweight tester with a specified range of 250" H₂O and a stated accuracy of 0.015% of the indicated reading.

Since the accuracy is stated as percent of indicated reading, the application error at both the 4" and 25" H₂O test points would be 0.015%.

6.2.3 Hysteresis, Linearity, Repeatability

As illustrated on Figure 6-2, hysteresis is defined as the maximum difference for the same measured quantity between the upscale and the down scale readings during a full range traverse in each direction. Linearity is defined as the maximum deviation of the instrument characteristics from a corresponding point on a specified straight line. If the straight line does not pass through zero, the difference between the location of the line and zero is defined as "Zero Offset". Repeatability is defined as the closeness of agreement among a number of consecutive measurements of the output of an instrument for the same value of the input under the same operating conditions, approaching the measurement from the same direction, and for full range traverses. This term is identical to the statistical "Precision" of a measurement. In general, the combined error from hysteresis, linearity and repeatability is stated as a single error percentage in instrument specifications.

Continuing the example, the hysteresis, linearity and repeatability are included within the accuracy specification of most of the electronic digital gauges, therefore the incremental contribution of both the example (A) and (B) gauges to the overall accuracy of these instruments is zero.

For the deadweight tester, the repeatability or precision is usually specified as a separate portion of the accuracy statement. For the example, the repeatability of the deadweight tester is estimated at 0.005% of the indicated reading.

6.2.4 Temperature Effect

The "Temperature Coefficient" is a measure of the change of a parameter as a result of a change in ambient temperature. It is generally expressed as a percentage change in the parameter per degree of change (Percent/ °C or Percent/°F).

The electronic digital gauge (A) example is not temperature compensated. The temperature coefficient is specified as 0.01% full scale per °F. The calibration temperature is 68°F. The maximum

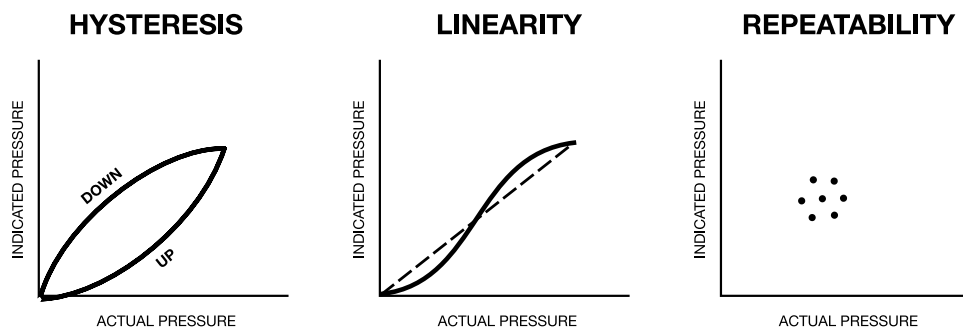

Figure 6-2
Precision- The Random Error Observed in a set of Repeated Measurements

application temperature difference is:

$$68^{\circ}\text{F} - 20^{\circ}\text{F} = 48^{\circ}\text{F}$$

Temperature error = $48^{\circ}\text{F} \times 0.01\% = 0.48\%$ full scale

$$0.48\% \text{ full scale} \times 280'' \text{H}_2\text{O} (\text{Full scale}) = 1.344'' \text{H}_2\text{O}$$

Application temperature error @ $4'' \text{H}_2\text{O} =$

$$1.344'' \text{H}_2\text{O} / 4'' \text{H}_2\text{O} (\text{Low Application Pressure}) \times 100 = 33.6\%$$

Application temperature error @ $25'' \text{H}_2\text{O} =$

$$1.344'' \text{H}_2\text{O} / 25'' \text{H}_2\text{O} \times 100 = 5.376\%$$

Electronic pressure gauge (B) is temperature compensated over a range of 20° to 130°F (-7 to 54°C). The temperature coefficient portion of the overall efficiency is zero.

The deadweight tester is not temperature compensated but has a very low temperature coefficient. The temperature coefficient is 0.0009278% per $^{\circ}\text{F}$. The calibration temperature is 73.4°F .

The maximum application temperature differential is:

$$73.4^{\circ}\text{F} - 20^{\circ}\text{F} = 53.4^{\circ}\text{F}$$

Temperature error =

$$53.4^{\circ}\text{F} \times 0.0009278\% = 0.049\%$$

Application temperature error =

$$(4'' \text{ and } 25'' \text{H}_2\text{O}) = 0.049\%$$

6.2.5 Resolution

Resolution is defined as the least incremental value of input or output that can be detected, caused, or otherwise discriminated by the measuring device. This parameter is best illustrated by the following example of a 100 PSI capacity

instrument. At 100 PSI, if the instrument has 3 digits, it can display only 99.6 to 100.4 PSI with a potential resolution error of .4%. If the display is 4 digits, the error is reduced to 99.96 to 100.04 PSI or 0.4%. A five digit display reduces the error to 99.996 to 100.004 PSI or 0.004%. However, with the same instrument, if the measurement is measuring 10 PSI the 3 digit measurement is 9.6 to 10.4 PSI or 4%, the 4 digit instrument is 9.96 to 10.04 PSI or 0.4% and the 5 digit measurement is 9.996 to 10.004 PSI or 0.04%.

Resolution error is not additive to other error parameters but the overall error can never be less than the instrument resolution at the lowest point of measurement.

The electronic digital pressure gauge (A) has a 3 1/2 digit display with one decimal maximum (0.1" H₂O). The maximum resolution error is therefore:

4" H₂O:

$$0.1" \text{ H}_2\text{O} / 4" \text{ H}_2\text{O} \times 100 = 2.5\%$$

25" H₂O:

$$0.1 \text{ H}_2\text{O} / 25" \text{ H}_2\text{O} \times 100 = 0.4\%$$

Electronic pressure gauge (B) has a 5 digit display with a 3 decimal maximum (0.001" H₂O). Maximum resolution error is therefore:

4" H₂O:

$$0.001" \text{ H}_2\text{O} / 4" \text{ H}_2\text{O} \times 100 = 0.025\%$$

25" H₂O:

$$0.001" \text{ H}_2\text{O} / 25" \text{ H}_2\text{O} \times 100 = 0.004\%$$

The deadweight tester does not have a display, therefore the resolution error component of the overall application accuracy is not applicable.

6.2.6 Stability

Stability is defined as the ability of an instrument to maintain the measurement accuracy over a specified time period. All instruments must be calibrated after some time interval to assure that the accuracy performance has not degraded. The shorter the stability time period, the more frequently the instrument must be recalibrated. Recalibration of some instruments can be done by the customer while other types must be returned to the manufacturer.

The stability or frequency of calibration requirement is seldom included within the advertised literature for secondary pressure standards. Users frequently must consult the manufacturer for recommended intervals.

6.2.7 Laboratory Uncertainty

Laboratory uncertainty is defined as the ability or certainty of a laboratory to measure the specific parameters necessary to establish the various elements of the instrument accuracy. Currently this measure is only applied to national standards laboratories such as United States National Institute of Standards and Technology and a few manufacturers of equipment for primary standards laboratories. A world wide program is underway to accredit laboratories with regard to their capability. This measure should become more important in the future.

6.2.8 Overall Accuracy

In order for the user to determine the overall accuracy of measurement for each application it is necessary to consider all of the elements contributing to the accuracy of measurement together with the minimum and maximum pressure and ambient temperatures for the planned application.

A Worksheet for Estimated Overall Accuracy is shown on Figure 6-3. This worksheet can be used to evaluate alternate instruments for individual applications.

For the three instruments that have been used for the example, the overall accuracy at the 4 and 25 inch H₂O test conditions are as follows:

*Table 6-1
Overall Accuracy and Characteristics of Test Devices*

Accuracy Element	Deadweight Tester		Digital (A)		Digital (B)	
	4"H2O	25"H2O	4"H2O	25"H2O	4"H2O	25"H2O
Accuracy	0.015%	0.015%	9.5%	1.52%	1.1345%	0.24032%
Hysteresis	0.005%	0.005%	-	-	-	-
Temperature	0.049%	0.049%	33.6%	5.376%	-	-
Total	0.069%	0.069%	43.1%	6.986%	1.1345%	0.24032%
Resolution	-	-	2.5%	0.4%	0.025%	0.004%
Application Accuracy	0.069%	0.069%	43.1%	6.986%	1.1345%	0.24032%

Figure 6-3
Worksheet Estimated Overall Accuracy for
Pressure Calibration Instruments

Instrument	Model	Range

I. Application

Measurement Pressure: High Low
 Ambient Pressure: High Low

II. Instrument Accuracy

A. Accuracy %: Indicated Reading Full Scale ±1 LSD

Pressure Errors: Indicated Reading
 Full Scale
 Least Significant Digit

Total Error Low Measured Pressure x 100 = %

B. Precision, Hysteresis, Repeatability: Included in Accuracy = %
 NOT Included in Accuracy

C. Temperature Compensated YES NO Range to

Temperature Effect: % °F
 Full Scale Indicated Reading Cal Temp.

Temperature Differential: High Temp. - Cal Temp. or,
 Cal Temp. - Low Temp.

1. If % Full Scale: Temp. Diff. x Temp. Effect = % FS

$$\frac{\text{Temp. Diff.} \times \text{Temp. Effect}}{\text{Low Measured Pressure}} \times 100 = \text{Result} \%$$

2. If % Indicated Reading:
 Temp. Diff. x Temp. Effect = %

III. Resolution

Instrument Display Digits Decimal, Maximum

$$\frac{\text{Low Measured Increment}}{\text{Low Measured Pressure}} \times 100 = \text{Result} \%$$

IV. Overall Accuracy for Application

- SUM of IIA, IIB, IIC1 or IIC2 %
- Resolution III %
- Overall Accuracy (Greater IV1 or IV2) %

Chapter 7

Selection of a Pressure Measurement Standard

The selection of a pressure calibration standard is a critical decision in the success of many industries. If the standard is not sufficiently accurate, significant losses both of revenue and/or process control can occur. On the other hand, if the standard is excessively accurate for the task being performed, cost of the standard may be too high and the labor time to calibrate may be high. It is important, therefore, for the potential user of a pressure standard to investigate both the needs of the task requiring the pressure standard and the overall costs associated with each pressure standard that is being considered.

7.1 Application Considerations

Many different types of pressure calibration standards are available. In order for the user to select the correct tester, several aspects of the task to be performed should be considered.

7.1.1 Test Fluid

An important element is the test fluid. Since the test fluid will enter the pressure sensing element of the instrument being tested, the test fluid must be compatible with the process fluid to which the instrument will be attached. Otherwise, all instruments must be cleaned after testing, an expensive operation. The most common test fluid is instrument grade mineral oil. Where useable, oil provides an outstanding combination of corrosion resistance with lubrication of the close fitting parts of the pressure standard. Distilled water also provides an excellent test fluid which is inert to most process fluids. Clean, dry air or nitrogen gas however, eliminates the problem altogether.

7.1.2 Pressure Range

A survey should be made of the pressure range of all instruments to be tested. The pressure standard should be capable of producing pressures in excess of the highest instrument to be tested. Care must be taken to consider the accuracy of the pressure standard at the lowest pressure to be tested. Several pressure standards of different ranges may be required to maintain acceptable levels of accuracy.

7.1.3 Task To Be Performed

Consideration should be given to the task to be performed. If most of the instruments to be tested are fixed in place, such as recorders, transmitters, etc. the portability of the instrument is important. If air transportation is required, such as oil/gas platforms, the size and weight is important. If many instruments are to be tested, dual column dead weight testers which change test range quickly should be considered. If many technicians will use the tester, the tester should be rugged and relatively independent of operator technique. High performance tasks, such as testing of instruments at manufacture, require custom designed testers.

7.2 Cost of Measurement

The most important consideration in the selection of a pressure standard should be the potential loss of revenue resulting from the use of the instrument. If the pressure standard is used to measure the quantity of product either being purchased or sold then the accuracy of pressure measurement can be directly related to the profit or loss to the user. In other instances, the pressure measurement is related to the efficiency of a piece of equipment or process and can again be directly related to profit or loss. Another use of pressure standards may be the test or calibration of safety related equipment. In this instance the consequences of failure should be considered when selecting the pressure standard. On the other hand, some pressure measurements are made for routine maintenance activities with minimal consequences of failure. Each of these considerations will be discussed in more detail in the following paragraphs.

A Worksheet for determining the economic analysis is shown on Figure 7-1. This worksheet can be used to evaluate various instruments for any desired application.

7.2.1 Custody Transfer

The custody transfer involves the use of a pressure standard to determine the quantity of a

commodity to be purchased or sold by a customer. A typical example is a natural gas pipeline wherein all natural gas entering the pipeline is being purchased and all gas leaving the pipeline is being sold. The quantity of gas in each transaction is determined by a measurement of flow across a meter, usually an orifice plate.

For purposes of this analysis the flow rate at a single metering station is assumed as 1,000,000 cubic feet per day at a 25" H₂O test point, the price of natural gas is estimated at \$2.00 per 1000 cubic feet.

The equation for flow through an orifice meter is:

$$\text{Flow} = C \times \text{SQRT}(\Delta P \times P_s)$$

Where:

- C = Flow constant
- P = Differential pressure over the orifice plate
- P_s = Static pressure at the meter

At the 4" H₂O calibration point, the flow rate is:

$$\begin{aligned} \text{Flow}(4" \text{H}_2\text{O}) &= \\ 1,000,000 \text{ Ft}^3/\text{Day} \times \text{SQRT}(4" \text{H}_2\text{O}/25" \text{H}_2\text{O}) & \\ &= 400,000 \text{ Ft}^3/\text{Day} \end{aligned}$$

As computed in Chapter 6, the overall accuracy of the deadweight tester at 4" H₂O was 0.069% and at 25" H₂O was 0.069%. The overall accuracy of digital (A) at 4" H₂O was 43.1% and at 25" H₂O was 6.986%. For digital (B) the accuracy at 4" H₂O was 1.1345% and at 25" H₂O was 0.24032%.

The estimated measurement accuracy losses per test station for these three examples are therefore:

A. Deadweight Tester

$$\text{Error}(4" \text{H}_2\text{O}) = 4" \text{H}_2\text{O} \times 0.069\% = 0.00276" \text{H}_2\text{O}$$

$$\text{Error}(25" \text{H}_2\text{O}) = 25" \text{H}_2\text{O} \times 0.069\% = 0.01725" \text{H}_2\text{O}$$

$$\begin{aligned} \text{Loss}(4" \text{H}_2\text{O}) &= 400,000 - 400,000 \text{ SQRT}(4 - 0.00276)/ \\ \text{SQRT}(4) &= 138 \text{ Ft}^3/\text{Day} \times 365 \text{ days} \times \$2.00/\text{MCF} = \\ &= \underline{\$100.74 \text{ per Year}} \end{aligned}$$

$$\begin{aligned} \text{Loss}(25" \text{H}_2\text{O}) &= \\ 1,000,000 - 1,000,000 \text{ SQRT}(25 - 0.01725)/\text{SQRT}(25) & \\ = 345 \text{ Ft}^3/\text{Day} \times 365 \text{ Days} \times \$2.00/\text{MCF} &= \\ \underline{\$251.85 \text{ per Year}} \end{aligned}$$

B. Digital Electronic Tester (A)

$$\begin{aligned} \text{Error}(4" \text{H}_2\text{O}) &= 4" \text{H}_2\text{O} \times 43.1\% = 1.724" \text{H}_2\text{O} \\ \text{Error}(25" \text{H}_2\text{O}) &= 25" \text{H}_2\text{O} \times 6.986\% = 1.7465" \text{H}_2\text{O} \end{aligned}$$

$$\begin{aligned} \text{Loss}(4" \text{H}_2\text{O}) &= \\ 400,000 - 400,000 \text{ SQRT}(4 - 1.724)/\text{SQRT}(4) &= 98,272 \text{ Ft}^3/ \\ \text{Day} \times 365 \text{ Days} \times \$2.00/\text{MCF} &= \\ \underline{\$71,738.56 \text{ per Year}} \end{aligned}$$

$$\begin{aligned} \text{Loss}(25" \text{H}_2\text{O}) &= \\ 1,000,000 - 1,000,000 \text{ SQRT}(25 - 1.7465)/\text{SQRT}(25) & \\ = 35,562 \text{ Ft}^3/\text{Day} \times 365 \text{ Days} \times \$2.00/\text{MCF} &= \\ \underline{\$25,960.99 \text{ per Year}} \end{aligned}$$

C. Digital Electronic Tester (B)

$$\begin{aligned} \text{Error}(4" \text{H}_2\text{O}) &= 4" \text{H}_2\text{O} \times 1.1345\% = 0.04538" \text{H}_2\text{O} \\ \text{Error}(25" \text{H}_2\text{O}) &= 25" \text{H}_2\text{O} \times 0.24032\% = 0.06008" \text{H}_2\text{O} \end{aligned}$$

$$\begin{aligned} \text{Loss}(4" \text{H}_2\text{O}) &= 400,000 - 400,000 \text{ SQRT}(4 - 0.04538)/\text{SQRT}(4) \\ &= 2275 \text{ Ft}^3/\text{Day} \times 365 \text{ Days} \times \$2.00/\text{MCF} = \\ &= \underline{\$1660.75 \text{ per Year}} \end{aligned}$$

$$\begin{aligned} \text{Loss}(25" \text{H}_2\text{O}) &= 1,000,000 - 1,000,000 \text{ SQRT}(25 - 0.06008)/ \\ \text{SQRT}(25) &= 1202 \text{ Ft}^3/\text{Day} \times 365 \text{ Days} \times \$2.00/\text{MCF} = \\ &= \underline{\$877.46 \text{ per Year}} \end{aligned}$$

7.2.2 Process Control

Process control involves the use of a pressure standard to measure pressures that are critical to the efficiency and/or control of processes. An example of this type of application is the measurement of feed water pressure in steam powered electric generating plants. The operating efficiency of the plant is affected by the accuracy of measurement of this pressure. Other applications involve the uniform control of pressures within a process to assure optimum operating efficiency.

The worksheet for determining the economic analysis of various pressure standards is used in the identical manner as that illustrated in Section 7.2.1 except that the algorithm for process efficiency is substituted for the orifice plate flow algorithm.

7.2.3 Safety

Pressure standards are frequently used to test and/or calibrate safety related control systems. These systems may be designed to prevent overpressure within tanks or lines, overfilling of tanks, etc. with the potential of severe environmental damage, employee injury, etc.. If the pressure standard is not sufficiently accurate, the safety system may be certified as accurate and malfunction in the event of an emergency.

Using the three pressure standard examples from Section 7.2.1, consider a safety application wherein the actuation pressure is 4 inches of water column with a set point tolerance of one percent. The maximum pressure tolerance acceptable would be 1% x 4 inch Water Column or 0.04 Inches of Water. If a 4:1 margin of safety is required, only instruments with .04/4 or 0.01 inches of water accuracy would be acceptable. The deadweight tester (0.069%) would then be the only acceptable instrument for the test.

7.2.4 Maintenance

Many pressure measurements are made only to verify that the operating pressure recording devices are operating. Accuracy of measurement is generally not a major concern for this type of application. Of concern may be the size, weight, portability and cost of the pressure standard.

As an example, consider that a customer has an application that utilizes process gauges with accuracy of $\pm 3.0\%$, and a minimum range of 25 Inches of water. The actual error of this equipment would be $3.0\% \times 25 \text{ inch Water Column} = 0.75 \text{ inch Water Column}$. Of the three examples evaluated in Section 7.2.1 both the deadweight tester (0.069%) and the digital gauge (B) (0.24032%) would be acceptable solutions. The final consideration would then be the size, weight, portability, ease of use and cost of each instrument.

7.3 Summary and Conclusions

Many different factors must be considered when selecting a pressure standard. The customer must consider the requirements of the task to be performed, the overall accuracy of the pressure standard for the application, any specific application considerations including the test fluid, pressure range and the task to be performed, the cost of inaccurate pressure measurement either on the purchase or sale of product, the adequacy of the pressure standard to test or adjust safety related systems or specific requirements for routine maintenance inspections.

Figure 7-1
Worksheet Economic Analysis Pressure Measurement Instrument

Instrument	Model	Range

Overall Accuracy:

Test Point:

Cost:

Application: Custody Transfer
 Process Control
 Safety
 Maintenance

I. Custody Transfer

Product Test: Rate of Flow Pressure Other

A. Rate of Flow (% Overall Accuracy x Test Pressure = Actual Error)

$$\text{[]} \times \text{[]} = \text{[]} \text{ Actual Error}$$

Dollar Loss: Flow Equation (Orifice Meter): $F = C \times \text{SQRT}(\Delta P \times P_g)$

Flow = C x SQRT Test Point = Actual Error

Flow = C x SQRT Actual Error = Indicated Error

$$\text{Error} = \frac{\text{[] Actual Error} - \text{[] Indicated Error}}{\text{[] Actual Error}} \times 100 = \text{[] \% Error}$$

$$\text{Flow/Day} = \text{[]} \times \text{Cost []} \times \% \text{ Error []} = \text{[]} \text{ Loss/Day}$$

II. Process Control

Test Instrument: (% Overall Accuracy x Test Pressure = Actual Error)

$$\text{[]} \times \text{[]} = \text{[]} \text{ Actual Error}$$

Dollar Loss: Using Your Process Efficiency Algorithm, compute:

1. Process Error resulting from Actual Pressure Error

2. Cost of Process Error

Process Error = x Cost = Loss/Test

Test/Day = x Loss/Test = Loss/Day

III. Safety

Test Instrument:

% Overall Accuracy x Test Pressure = Actual Error

Safety Parameters:

Process Maximum Pressure
 Setpoint Minimum Pressure

Potential Loss:

Employee Injury Equipment

Safety Analysis:

- Instrument is adequate
- Instrument is not adequate

IV. Maintenance

Test Instrument:

% Overall Accuracy x Test Pressure = Actual Error

Special Requirements:

- Portable
- Size
- Weight
- Other _____

Maintenance:

Task: _____ Setpoint _____ Tolerance _____

Maintenance Evaluation:

- Instrument is adequate
- Instrument is not adequate

Appendix

References

- 1 P.L.M. Heideman, B.E. Welch, Part 3, Piston Gages, Pure and Applied Chemistry, Experimental Thermodynamics, Volume II Experimental Thermodynamics of Non-reacting Fluids
- 2 Handbook US National Bureau of Standards No. 77, Vol.III, "Precision Measurement and Calibration".
- 3 Bowman, H.A. and R.M. Schoonover. J. Res. Nat. Bur. Std. 71C,179 (1967).
- 4 Belanger, Brian C., "Traceability, An Evolving Concept", ASTM Standardization News, Vol.8, Number 1.
- 5 Taylor, Barry N & Kuyatt, Chris E., NIST Technical Note 1297, "Guidelines for Evaluating and Expressing the Uncertainty of Uncertainty of NIST Measurement Results".
- 6 Fawcett, L.W. Jr., AMETEK Engineering. Report 312, "Measurement Uncertainty in the Calibration Process for Deadweight Testers".
- 7 Factors Affecting Performance of Piston Gauges", National Bureau of Standards, 6.2 February 1957.
- 8 Reed, C.J., AMETEK Engineering Report 247, "Calibration of Pressure Standards".
- 9 Dadson, R.S., Lewis, S.L., Peggs, G.N., "The Pressure Balance, Theory and Practice", Her Majesties Stationary Office, London, 1982.
- 10 Delajoud, P., Girard, M., "Increasing the Accuracy of pressure Measurements Through Improved Piston Gauge Area Determination", Instrument Society of America.
- 11 Legras, J.C., Schatz, B., Delajoud, P., "La Reference National de Pression Du BNM dans la Domaine de 10 a 400 kPa", Reference National de Pression BNM.
- 12 Bridge, M.L., "Internal Calibration Chain", Proceedings for Measurement Science Conference, January 1993.
- 13 Reed, C.J., "Effective Use of Deadweight Testers", Proceedings for The International School of Hydrocarbon Measurement, May 1993
- 14 Drake, Charles P., Natural Gas Pipeline of America, Proceedings of AGA Gulf Coast Measurement Short Course, Houston, Texas, 1974.
- 15 "Manometer Principles", Meriam Instrument, a Scott Fetzer Company
- 16 Harland, P.H., "Pressure Gauge Handbook", by AMETEK, Marcel Dekker Incorporated

Pressure Terms & Definitions

GENERAL TERMS

AMETEK CERTIFICATION - The document stating the device, either a tester, piston & cylinder, or weights, the guaranteed accuracy of the device, the device serial number, certification (not the actual test date), and the recommended recertification date (normally 1 year), the National Bureau of Standards traceability report numbers, and the test conditions. The purchase order number is included so that proof of certification can be directly connected to a specific device and a specific Purchase Order.

CERTIFICATION WITH DATA - This is a second page to the certification. The document reports all of the testers measured particulars, (e.g. effective area, "B" pressure coefficient, etc.) The masses of each weight in the weight set is also reported as well as nominal and actual pressures. The customer can use this information to conduct more accurate tests than simply just working to the accuracy of the tester. With this information the customer can calculate his own actual pressures per the equations on the back of his certification.

CROSSFLOAT - A testing method or procedure which compares a known pressure for the purpose of determining the effective area of the unknown pressure source.

DEADWEIGHT GAUGE - A device used to measure pressure, using a known area and mass (deadweights).

DEADWEIGHT TESTER - A device used to generate or produce a known pressure, using a known area and masses (deadweights).

GAUGE - This term is normally used with reference to pressure requirements.

GAGE - this term is normally used with reference to dimensional requirements, such as a "Go-No Go" Plug Gage.

INSTRUMENT AIR - Air defined by the ISA - S7.3 standard.

NIST REPORT NO. - This number appears on the certification for each tester. Numbers preceded by "P" e.g. P-7800 represent pressure test report numbers assigned by and on file with the NIST temperature and pressure measurements and standards division center for absolute physical quantities. Numbers such as 212.31/193712 are NBS numbers used in calibrating the weights used to calibrate AMETEK scales. All of these numbers are part of the traceability reported to the customer.

TEMPERATURE COEFFICIENT - As the piston and cylinder or ball and nozzle heat up or cools, their linear dimension changes, thus affecting the effective area. The temperature coefficients are well documented for the materials AMETEK uses and are reported in case the customer wishes to use his own computations.

TRANSDUCER - A device for converting mechanical stimulation into an electrical signal. It is used to measure quantities like pressure, temperature and force.

ACCURACY

ACCURACY - The closeness or agreement between a measured value and a standard or true value; uncertainty as used herein, is the maximum inaccuracy or error that may reasonably be expected.

PRECISION ERROR - The random error observed in a set of repeated measurements. This error is the result of a large number of small effects, each of which is negligible alone.

TRUE VALUE - The reference value defined by the National Institute of Standards & Technology which is assumed to be the true value of any measured quantity.

UNCERTAINTY (U) - The maximum error reasonably expected for the defined measurement process.

CALIBRATION

CALIBRATION - The process of comparing and correcting the response of an instrument to agree with a standard instrument over the measurement range.

CALIBRATION HIERARCHY - The chain of calibrations which link or trace a measuring instrument to the National Bureau of Standards.

LABORATORY STANDARD - An instrument which is calibrated periodically at the NIST. The laboratory standard may also be called an interlab standard.

NIST - National Institute of Standards & Technology. The reference or source of the true value for all measurements in the United States of America.

TRACEABILITY - The ability to trace the calibration of a measuring device through chain of calibrations to the NIST.

TRANSFER STANDARD - A laboratory instrument which is used to calibrate working standards and which is periodically calibrated against the laboratory standard.

WORKING STANDARD - An instrument which is calibrated in a laboratory against an interlab or transfer standard and is used as a standard in calibrating measuring instruments.

HYDRAULIC TESTER TERMS

ACTUAL AREA (PISTON) - The area as determined by measuring the piston with a dimensional gage.

CONTROLLED-CLEARANCE PISTON & CYLINDER - This design permits an external pressure to be exerted around the cylinder thus controlling the clearance between the piston and cylinder. While this device is sophisticated and cumbersome to use, it is well documented and is the primary standard used by the NIST.

EFFECTIVE AREA (PISTON & CYLINDER OR BALL & NOZZLE) - The area as determined by a calibration process, such as crossfloating.

NOMINAL AREA (PISTON) - An ideal specific area which is not measured, but is used as a reference. In the case of AMETEK pistons, nominal areas are as follows: 0.01, 0.05, 0.02, 0.1 square inch.

"B" PRESSURE COEFFICIENT - This term represents the piston's non-linearity. As the pressure increases in a hydraulic tester the piston and cylinder experience large stresses which change the effective area. Depending on the piston and cylinder shape the value of "B" can be (+) or (-).

SURFACE TENSION - As fluid leaks up between the piston and cylinder it puts an upward force on the piston, this is a result of the fluid surface tension acting on the circumference of the piston.

SIMPLE PISTON & CYLINDER - A piston and cylinder design which permits pressure to be applied only to the piston. This is represented by hydraulic cylinders used in machinery.

RE-ENTRANT CYLINDER - This design allows the pressure being exerted on the piston to also act on the cylinder. As pressure increases the cylinder is being forced to reduce the fluid leakage between the piston and cylinder. The AMETEK Type T & R series testers and gauges are of this design.

MASS TERMS

AIR BUOYANCY - When considering the load on the piston and cylinder in a deadweight tester, the load has to be reduced by an amount equal to the mass of the air displaced by the weights.

APPARENT MASS - Mass of a weight as referenced to the density of a comparison mass. When weights are weighed on scales, the internal calibration standard of the scale is normally brass or stainless steel. AMETEK uses brass thus all masses are reported as apparent mass against a brass standard.

CALIBRATION GRAVITY - The gravity of the location for which the tester was calibrated. Note, this is not necessarily the same as the gravity of the location in which the tester was calibrated.

GRAVITY - Since dead weight testers rely on known masses to generate known pressures it is necessary to correct the mass of the weight for different gravities. The weights for all dead weight testers are referenced to or calibrated at a specific gravity. When correcting for a change in gravity, it is only necessary to take a ratio of the local gravity to the calibrated gravity and multiply it by the pressure. See the handbook for a further explanation.

LOCAL GRAVITY - The gravity of the area of location in which the tester is being used.

TRUE MASS - Mass of a weight as referenced to its own density.

PNEUMATIC TESTER TERMS

ACTUAL WEIGHT FACTOR - The weight Factor computed by using a pneumatic tester's effective area, or by an actual calibration at a specific test point.

HI/LO WEIGHT FACTOR - The average weight factor of the highest and lowest actual weight factors determined by calibration at AMETEK. The HI/LO weight factor is also called the average weight factor or the reported weight factor. This value is used to calculate all actual pressures. Reported on the certification with data.

NOMINAL WEIGHT FACTOR - This term corresponds to the hydraulic nominal area terminology. The nominal weight factor for the pneumatic testers are as follows:

PK:	200.51 grams/PSI
RK:	100.25 grams/PSI
HK:	20.05 grams/PSI

NOTE: The RK is 1/2 the PK and HK is 1/10 the PK so that all the areas are multiples of each other.

WEIGHT FACTOR - A term used by AMETEK to describe the relationship between the ball area and the mass required to generate 1 PSIG. Weight factor is defined as grams/PSI.

PRESSURE TERMS

ACTUAL PRESSURE - The pressure measured by a gauge or generated by a tester.

ABSOLUTE PRESSURE (PSIA) - Pressure measured with reference to zero gauge pressure, or a perfect vacuum. Atmospheric pressure is absolute pressure or about 14.7 Measurement PSIA. 0 PSIA would be a perfect vacuum.

BACKGROUND, LINE, OR STATIC PRESSURE - The magnitude or pressure in a differential pressure gauge, or transmitter. This pressure could be at 3000 PSIG, but the differential pressure may only be 1 PSID. This means that one side of the device could be 3000 PSIG and the other side at 3001 PSIG.

DIFFERENTIAL PRESSURE (PSID) - The difference between two pressures as measured by a differential pressure gauge.

GAUGE PRESSURE (PSIG or PSI) - Pressure measured with reference to atmospheric pressure. 14.7 PSIA is equal to 0 PSIG.

NOMINAL PRESSURE - An ideal specific pressure used as a reference. Generally this would be the pressure desired by a gauge user. The difference between the nominal pressure and the actual pressure represent the accuracy of that pressure.

VACUUM - A negative gauge pressure, with the maximum (or perfect vacuum) having no atmosphere pressure, i.e. about -14.7 PSIG or 0 PSIA.