

UNI-T®

Instruments.uni-trend.com



User's Manual

MSO2000X/3000X Series Mixed Signal Oscilloscope

This document applies to the following models:

MSO2000X series

MSO3000X series

V1.0

2024.05.29

1.888.610.7664

 www.calcert.com

sales@calcert.com

Foreword

Dear Users,

Hello! Thank you for choosing this brand new UNI-T instrument. In order to use this instrument safely and correctly, please read this manual thoroughly, especially the Safety Requirements part. After reading this manual, it is recommended to keep the manual at an easily accessible place, preferably close to the device, for future reference.

Copyright Information

Copyright is owned by Uni-Trend Technology (China) Limited.

UNI-T is the registered trademark of Uni-Trend Technology (China) Co., Ltd.

Warranty Service

If the product is proved to be defective within the warranty period, UNI-T reserves the rights to either repair the defective product without charging of parts and labor, or exchange the defected product to a working equivalent product. Replacement parts and products may be brand new, or perform at the same specifications as brand new products. All replacement parts, modules, and products become the property of UNI-T.

The "customer" refers to the individual or entity that is declared in the guarantee. In order to obtain the warranty service, "customer" must inform the defects within the applicable warranty period to UNI-T, and to perform appropriate arrangements for the warranty service. The customer shall be responsible for packing and shipping the defective products to the designated maintenance center of UNI-T, pay the shipping cost, and provide a copy of the purchase receipt of the original purchaser. If the product is shipped domestically to the location of the UNI-T service center, UNI-T shall pay the return shipping fee. If the product is sent to any other location, the customer shall be responsible for all shipping, duties, taxes, and any other expenses.

This warranty shall not apply to any defects or damages caused by accidental, machine parts' wear and tear, improper use, and improper or lack of maintenance. UNI-T under the provisions of this warranty has no obligation to provide the following services:

- a) Any repair damage caused by the installation, repair, or maintenance of the product by non UNI-T service representatives.
- b) Any repair damage caused by improper use or connection to an incompatible device.
- c) Any damage or malfunction caused by the use of a power source which does not conform to the

requirements of this manual.

- d) Any maintenance on altered or integrated products (if such alteration or integration leads to an increase in time or difficulty of product maintenance).

This warranty is written by UNI-T for this product, and it is used to substitute any other express or implied warranties. UNI-T and its distributors do not offer any implied warranties for merchant ability or applicability purposes.

For violation of this guarantee, regardless of whether UNI-T and its distributors are informed that any indirect, special, incidental, or consequential damage may occur, UNI-T and its distributors shall not be responsible for any of the damages.

File Version



MSO2000X/3000X 20240529-V1.00













Statement

- UNI-T products are protected by patent rights in China and foreign countries, including issued and pending patents.
- UNI-T reserves the rights to any product specification and pricing changes.
- UNI-T reserves all rights. Licensed software products are properties of Uni-Trend and its subsidiaries or suppliers, which are protected by national copyright laws and international treaty provisions. Information in this manual supersedes all previously published versions.

1. Safety Requirements

This section contains information and warnings that must be followed to keep the instrument operating under safety conditions. In addition, user should also follow the common safety procedures.

Safety Precautions		
Warning	Please follow the following guidelines to avoid possible electric shock and risk to personal safety.	
	Users must follow the following conventional safety precautions in operation, service and maintenance of this device. UNI-T will not be liable for any personal safety and property loss caused by the user's failure to follow the following safety precautions. This device is designed for professional users and responsible organizations for measurement purposes. Do not use this device in any way not specified by the manufacturer. This device is only for indoor use unless otherwise specified in the product manual.	
Safety Statements		
Warning	"Warning" indicates the presence of a hazard. It reminds users to pay attention to a certain operation process, operation method or similar. Personal injury or death may occur if the rules in the "Warning" statement are not properly executed or observed. Do not proceed to the next step until you fully understand and meet the conditions stated in the "Warning" statement.	
Caution	"Caution" indicates the presence of a hazard. It reminds users to pay attention to a certain operation process, operation method or similar. Product damage or loss of important data may occur if the rules in the "Caution" statement are not properly executed or observed. Do not proceed to the next step until you fully understand and meet the conditions stated in the "Caution" statement.	
Note	"Note" indicates important information. It reminds users to pay attention to procedures, methods and conditions, etc. The contents of the "Note" should be highlighted if necessary.	
Safety Sign		
	Danger	It indicates possible danger of electric shock, which may cause personal injury or death.
	Warning	It indicates that you should be careful to avoid personal injury or product damage.
	Caution	It indicates possible danger, which may cause damage to this device or other equipment if you fail to follow a certain procedure or condition. If the "Caution" sign is present, all conditions must be met before you proceed to operation.

	Note	It indicates potential problems, which may cause failure of this device if you fail to follow a certain procedure or condition. If the "Note" sign is present, all conditions must be met before this device will function properly.
	AC	Alternating current of device. Please check the region's voltage range.
	DC	Direct current device. Please check the region's voltage range.
	Grounding	Frame and chassis grounding terminal
	Grounding	Protective grounding terminal
	Grounding	Measurement grounding terminal
	OFF	Main power off
	ON	Main power on
	Power	Standby power supply: when the power switch is turned off, this device is not completely disconnected from the AC power supply.
CAT I		Secondary electrical circuit connected to wall sockets through transformers or similar equipment, such as electronic instruments and electronic equipment; electronic equipment with protective measures, and any high-voltage and low-voltage circuits, such as the copier in the office.
CAT II		Primary electrical circuit of the electrical equipment connected to the indoor socket via the power cord, such as mobile tools, home appliances, etc. Household appliances, portable tools (e.g. electric drill), household sockets, sockets more than 10 meters away from CAT III circuit or sockets more than 20 meters away from CAT IV circuit.
CAT III		Primary circuit of large equipment directly connected to the distribution board and circuit between the distribution board and the socket (three-phase distributor circuit includes a single commercial lighting circuit). Fixed equipment, such as multi-phase motor and multi-phase fuse box; lighting equipment and lines inside large buildings; machine tools and power distribution boards at industrial sites (workshops).
CAT IV		Three-phase public power unit and outdoor power supply line equipment. Equipment designed to "initial connection", such as power distribution system of power station, power instrument, front-end overload protection, and any outdoor transmission line.
	Certification	CE indicates a registered trademark of EU
	Waste	Do not place equipment and its accessories in the trash. Items must be properly disposed of in accordance with local regulations.
	EFUP	This environment-friendly use period (EFUP) mark indicates that

		dangerous or toxic substances will not leak or cause damage within this indicated time period. The environment-friendly use period of this product is 40 years, during which it can be used safely. Upon expiration of this period, it should enter the recycling system.
Safety Requirements		
Warning		
Preparation before use		Please connect this device to AC power supply with the power cable provided; The AC input voltage of the line reaches the rated value of this device. See the product manual for specific rated value. The line voltage switch of this device matches the line voltage; The line voltage of the line fuse of this device is correct. It is not used to measure the main circuit.
Check all terminal rated values		Please check all rated values and marking instructions on the product to avoid fire and impact of excessive current. Please consult the product manual for detailed rated values before connection.
Use the power cord properly		You can only use the special power cord for the instrument approved by the local and state standards. Please check whether the insulation layer of the cord is damaged or the cord is exposed, and test whether the cord is conductive. If the cord is damaged, please replace it before using the instrument.
Instrument Grounding		To avoid electric shock, the grounding conductor must be connected to the ground. This product is grounded through the grounding conductor of the power supply. Please be sure to ground this product before it is powered on.
AC power supply		Please use the AC power supply specified for this device. Please use the power cord approved by your country and confirm that the insulation layer is not damaged.
Electrostatic prevention		This device may be damaged by static electricity, so it should be tested in the anti-static area if possible. Before the power cable is connected to this device, the internal and external conductors should be grounded briefly to release static electricity. The protection grade of this device is 4 kV for contact discharge and 8 kV for air discharge.
Measurement accessories		Measurement accessories are of lower class, which are definitely not applicable to main power supply measurement, CAT II, CAT III or CAT IV circuit measurement. Probe subassemblies and

	accessories within the range of IEC 61010-031 and current sensor within the range of IEC 61010-2-032 can meet its requirements.
Use the input / output port of this device properly	Please use the input / output ports provided by this device in a properly manner. Do not load any input signal at the output port of this device. Do not load any signal that does not reach the rated value at the input port of this device. The probe or other connection accessories should be effectively grounded to avoid product damage or abnormal function. Please refer to the product manual for the rated value of the input / output port of this device.
Power fuse	Please use power fuse of specified specification. If the fuse needs to be replaced, it must be replaced with another one that meets the specified specifications by the maintenance personnel authorized by UNI-T.
Disassembly and cleaning	There are no components available to operators inside. Do not remove the protective cover. Maintenance must be carried out by qualified personnel.
Service environment	This device should be used indoors in a clean and dry environment with ambient temperature from 0 °C - 40 °C。 Do not use this device in explosive, dusty or humid air.
Do not operate in humid environment	Do not use this device in a humid environment to avoid the risk of internal short circuit or electric shock.
Do not operate in flammable and explosive environment	Do not use this device in a flammable and explosive environment to avoid product damage or personal injury.
Caution	
Abnormality	If this device may be faulty, please contact the authorized maintenance personnel of UNI-T for testing. Any maintenance, adjustment or parts replacement must be done by the relevant personnel of UNI-T.
Cooling	Do not block the ventilation holes at the side and back of this device; Do not allow any external objects to enter this device via ventilation holes; Please ensure adequate ventilation, and leave a gap of at least 15 cm on both sides, front and back of this device.
Safe transportation	Please transport this device safely to prevent it from sliding, which may damage the buttons, knobs or interfaces on the instrument panel.
Proper ventilation	Poor ventilation will cause the device temperature to rise, thus

	causing damage to this device. Please keep proper ventilation during use, and regularly check the vents and fans.
Keep clean and dry	Please take actions to avoid dust or moisture in the air affecting the performance of this device. Please keep the product surface clean and dry.
Note	
Calibration	The recommended calibration period is one year. Calibration should only be carried out by qualified personnel.

1.1. Environmental Requirements

This instrument is suitable for the following environment.

- Indoor use
- Pollution degree 2
- Overvoltage category: This product should be connected to a power supply that meets Overvoltage Category II. This is a typical requirement for connecting devices via power cords and plugs.
- In operating: altitude lower than 3000 meters; in non-operating: altitude lower than 15000 meters
- Unless otherwise specified, operating temperature is 0 to +40°C; storage temperature is -20 to + 70
- In operating, humidity temperature below to +35°C, ≤90% RH. (Relative humidity); In non-operating, humidity temperature +35°C to +40°C, ≤60% RH. (Relative humidity).

There are ventilation opening on the rear panel and side panel of the instrument. So please keep the air flowing through the vents of the instrument housing. To prevent excessive dust from blocking the vents, please clean the instrument housing regularly. The housing is not waterproof, please disconnect the power supply first and then wipe the housing with a dry cloth or a slightly moistened soft cloth.

1.2. Connecting Power Supply

The specification of input AC power.

Voltage Range	Frequency
100V ~ 240VAC (fluctuant: ±10%)	50 Hz/60 Hz
100V ~ 120VAC (fluctuant: ±10%)	400 Hz

Please use the attached power lead to connect to the power port.

Connecting to service cable

This instrument is a Class I safety product. The supplied power lead has good performance in terms of case ground. This spectrum analyzer is equipped with a three-prong power cable that meets international safety standards. It provides good case grounding performance for the specification of your country or region.

Please install AC power cable as follow.

- Ensure the power cable is in a good condition.
- Leave enough space for connecting the power cord.
- Plug the attached three-prong power cable into a well-grounded power socket.

1.3. Electrostatic Protection

Electrostatic discharge may cause damage to component. Components can be damaged invisibly by electrostatic discharge during transportation, storage and use.

The following measure can reduce the damage of electrostatic discharge.

- Testing in anti-static area as far as possible.
- Before connecting the power cable to the instrument, inner and outer conductors of the instrument should be briefly grounded to discharge static electricity.
- Ensure all the instruments are properly grounded to prevent the accumulation of static.

2. Introduction

This manual is to introduce the safety requirements, installment and the operation of MSO2000X/3000X series mixed signal oscilloscope.

3. MSO2000X/3000X Series

MSO2000X/3000X series mixed signal oscilloscope has 5 models.

Model	Analog channel number	Analog bandwidth	Digital	Gen
MSO2304X	4	300MHz	●	○
MSO2204X	4	200MHz	●	○
MSO2104X	4	100MHz	●	○
MSO3054X	4	500MHz	●	○
MSO3034X	4	350MHz	●	○

○: option ●: standard ×: not support

MSO2000X/3000X series mixed signal oscilloscope is a versatile, high-performance oscilloscope based on UNI-T's original Ultra Phosphor technology, which achieves the perfect combination of ease of use, excellent technical specifications, and a host of functional features to help users complete their test work faster. It is an oscilloscope designed for general purpose design/debug/test needs in the widest range of digital oscilloscope markets including communications, semiconductors, computers, instrumentation, industrial electronics, consumer electronics, automotive electronics, field maintenance, R&D/education, and many other areas.

4. Document Overview

This user's manual is used to guide the user quickly understand the front/rear panel, user interface and basic operation of MSO2000X/3000X series mixed signal oscilloscope.

Note : The latest edition of the user's manual can download from UNI-T website

(1) Software version

The software update may change or add new function, please subscribe UNI-T website for the latest version or contact UNI-T to upgrade the software.

(2) Document format

a. Key

A key with character frame represents that the key on the front panel. For example, Default represents the "Default" key.

b. Menu

Double quotation marks represents a menu or a pop-up menu. For example, "Channel Setting" pop-up menu on the operation interface, click on the "Vertical Scale" to operate and set the vertical scale settings.

c. Operation steps

Use an arrow ">" represent next step, for example, "Storage > Save" represents that in storage menu, click on "Storage" at first, and then click on "Save" to save the waveform, setting or picture file.

d. "Square brackets + Word" represents the connector on the front/rear panel, for example, [AUX OUT].

e. Hyperlink

"Underline + Blue word" represents a hyperlink, for example, [Connecting Power Supply](#)

f. Rotary knob

A key with underline represents a rotary knob, for example, Position represents the vertical rotary knob.

5. Getting Started Manual

- [General Inspection](#)
- [Before Use](#)
- [Front Panel](#)
- [Rear Panel](#)
- [Operation Panel](#)
- [User Interface](#)
- [Touch Screen](#)
- [Parameter Setting](#)
- [Remote Control](#)

This chapter is to introduce on using the MSO2000X/3000X series oscilloscope for the first time, the front and rear panels, the user interface, as well as touch screen function.

5.1. General Inspection

It is recommended to inspect the instrument follow the steps below before using the MSO2000X/3000X series oscilloscope for the first time.

(1) Check for Damages caused by Transport

If the packaging carton or the foam plastic cushions are severely damaged, please contact the UNI-T distributor of this product immediately.

(2) Check Attachment

Please check appendix for the list of accessories. If any of the accessories are missing or damaged, please contact UNI-T or local distributors of this product.

(3) Machine Inspection



If the instrument appears to be damaged, not working properly, or has failed the functionality test, please contact UNI-T or local distributors of this product.

If the equipment is damaged due to shipping, please keep the packaging and notify both the transportation department and UNI-T distributors, UNI-T will arrange maintenance or replacement.

5.2. Before Use

To perform a quick verification of the instrument's normal operations, please follow the steps below.

(1) Connecting to the Power Supply

Use the assembled power line or other power line that meets the local country standards to connect the oscilloscope. When the power switch  on the rear panel is not opened, the power soft indicator in the left bottom on the rear panel is extinguished, which indicates this soft switch key is no-effect. When the power switch  on the rear panel is opened, the power soft indicator in the left bottom on the rear panel is illuminated with red, and then press the soft switch key to enable the oscilloscope.

(2) Boot Check

Press the power soft switch key  and the indicator should change from red to green. The oscilloscope will show a boot animation, and then enter the normal interface.

(3) Connecting Probe

This oscilloscope provides 2 pieces of compensating signal probe. Connect the BNC of the probe to the BNC of oscilloscope's CH1, and connect the probe to the "probe compensating signal connection clip", and then connect the ground alligator clip of the probe with the ground terminal of compensating signal connection clip. The output of compensating signal connection clip: amplitude about 3 Vpp, frequency defaults to 1 kHz.

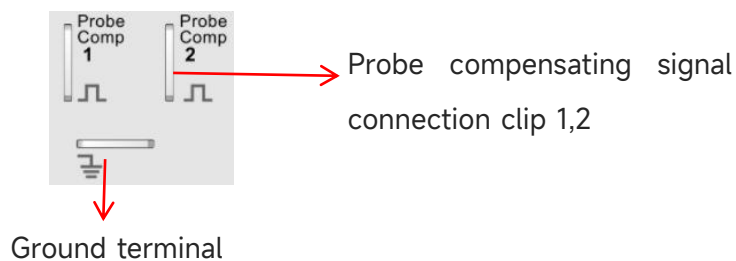

Probe Compensating Signal Connection Clip and Ground Terminal

(4) Function Check

Press the Autoset key, a square wave (amplitude 3 Vpp, frequency 1 kHz) should appear on the screen. Repeat the step 3 to check all channels.

(5) Probe Compensation

When the probe is connected to any input channel for the first time, this step might be adjusted to match the probe and the input channel. Probes that are not compensated may lead to measurement errors or mistake. Please follow the following steps to adjust the probe compensation.

- Set the attenuation coefficient in the probe menu to 10x and the switch of the probe at 10x,

and connecting the probe of the oscilloscope to CH1. If use the probe's hook head, make sure it stably touch to the probe. Connecting the probe to the "probe compensation signal connection clip" of the oscilloscope and connect the ground alligator clip to the ground terminal of probe compensating signal connection clip. Open CH1 and press the Autoset key.

- View the displayed waveform, as shown in the following figure.



- If the displayed waveform is look like the above "Insufficient Compensation" or "Excessive Compensation", use a non-metallic screwdriver to adjust the probe's variable capacitance until the display matches the "Correct compensation" waveform.

Warning: To avoid electric shock when using the probe to measure high voltage, please ensure that the probe insulation is in good condition and avoid physical contact with any metallic part of the probe.

5.3. Front Panel



Front Panel

No.	Description	No.	Description
1	Display area	10	Clear key
2	Quick screenshot key	11	Vertical control area
3	Multi-function area	12	Analog channel input terminal *
4	Touch/Lock key	13	Probe compensating signal connection clip and ground terminal
5	Common function area	14	Gen output port
6	Function menu key	15	Digital channel input port
7	Horizontal control area	16	USB HOST port
8	Trigger control area	17	Power soft switch key
9	Factory setting		

*MSO2000X have no probe power outlet board

5.4. Rear Panel

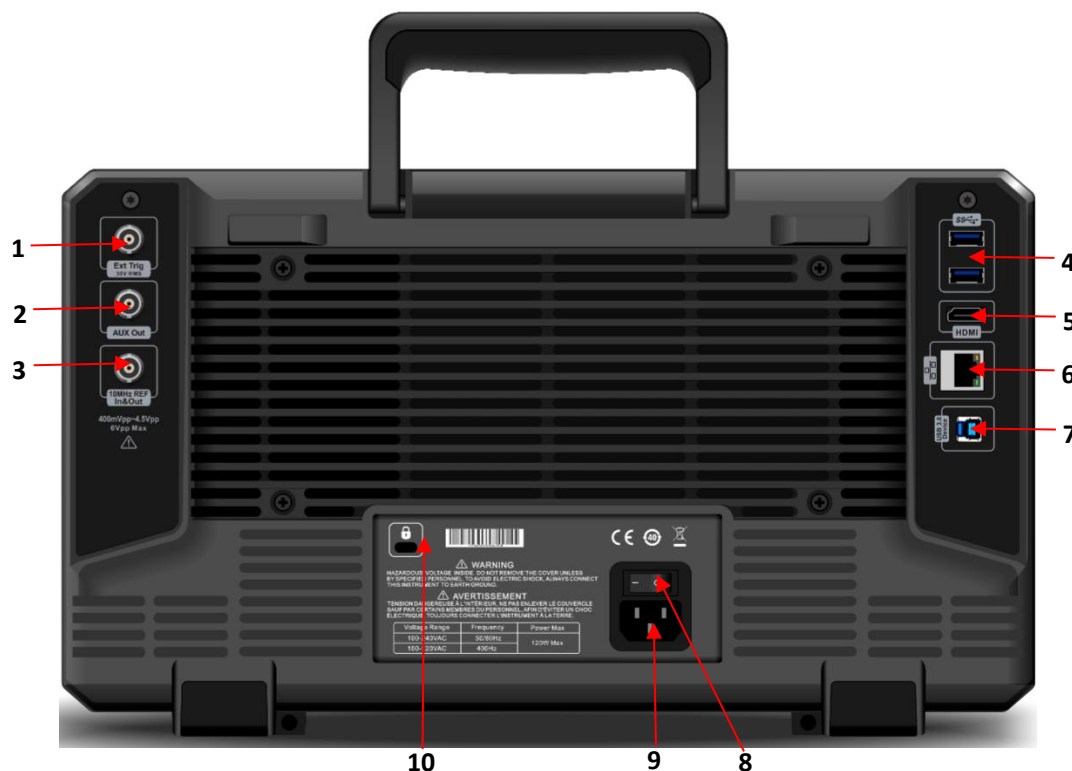

Rear Panel

1. EXT Trig: External trigger or the input terminal of external trigger/5
2. AUX OUT: Output terminal for trigger output, Pass/Fail output, DVM output

3. 10MHz REF: 10 MHz REF IN&OUT, BNC. Use this port to import the external reference clock signal or export 10 MHz clock signal generated by the internal crystal oscillator of the instrument.
4. USB HOST: Supports USB device
5. HDMI: Supports to connect an external displayer with HDMI port
6. LAN: Connects to LAN for remote control
7. USB Device: USB Device for communication between the oscilloscope and a PC
8. AC power input socket: Use the assembled power cable to connect the oscilloscope to AC power (the requirement of power supply: 100 ~ 240 V, 45 ~ 440 Hz)
9. Power switch: Open the power switch after AC power socket is connect correctly, the oscilloscope can be power up, at this point, press the power soft switch key on the front panel to turn on the oscilloscope
10. Safety lock: Lock the oscilloscope at fixed position (sold separately)

5.5. Operation Panel

(1) Vertical Control



- **Ref** : Loading the reference waveform from 'local or USB', so the measured waveform can compare with the reference waveform, and refer to the section of [16. Reference Waveform](#) for more details.
- **1** , **2** , **3** , **4** : Analog channel setting key respectively represents CH1, CH2, CH3 and CH4. Four channel's tab are identified by different colors and it also corresponding to the colors of waveforms on the screen and the channel input connectors. Press any keys to enter the related channel menu (activate or disable the channel), and refer to the section of [6. Vertical Channel Settings](#) for more details.
- **Math** : Press this key to open the mathematical operation menu to perform math operation (add, subtract, multiply, divide), digital filter and advanced operation, and refer to the section of [19. Mathematical Operation](#) for more details.
- **FFT** : Press this key to quickly open FFT setting, and refer to the section of [20. FFT](#) for more details.
- **Digital** : Press this key to enter Digital setting, to set basics, grouping, threshold, bus and label, and refer to the section of [21. Digital Channel](#) for more details.
- **BUS** : Press this key to enter protocol decoding setting, to set the decoding of RS232, I²C,

SPI, CAN, CAN-FD, LIN, FlexRay, I2S, 1553B, Manchester, SENT and ARINC429, and refer to the section of [9. Protocol Decoding](#) for more details.

- **Position**: Vertical position rotary knob is used to move the vertical position of the waveform in the current channel. Press this rotary knob to move the channel position back to the vertical midpoint.
- **Scale** : Vertical scale rotary knob is used to adjust the vertical scale in the current channel. Turn clockwise to decrease the scale, turn counterclockwise to increase the scale. The amplitude of waveform will increase or decrease with the adjustment and the scale at the



bottom of screen will change in real-time.

The vertical scale is step with 1-2-5, press this rotary knob to adjust the vertical scale between coarse tuning and fine tuning.

(2) Horizontal Control



- **Menu** : Horizontal menu key is used to display the horizontal scale, time base mode (XY/YT), horizontal, auto roll, quick roll time base, horizontal position, time base extension and time base selection, and refer to the section of [7. Horizontal System](#)

for more details.

- **Scale** : Horizontal scale rotary knob is used to adjust all channel time base. During the adjustment, the waveform is compressed or extended in horizontal show on the screen and the horizontal scale value will change in real-time. The time base is step with 1-2-5, press this rotary knob to adjust the horizontal scale between coarse tuning and fine tuning.

- **Position**: Horizontal position rotary knob is used to move the trigger point to left or right side that relative to the center of the screen. During the adjustment, all channel waveforms move to left or right side and the horizontal shift value on the top of the screen

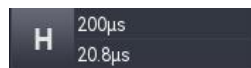

will change in real-time. Press this rotary knob to move the current position back to the horizontal midpoint.

(3) Trigger Control



- **Menu** : Display the trigger menu, refer to “[Trigger Settings](#)”.
- **Force** : Force trigger key is used to generate one trigger when the trigger mode is Normal and Single.
- **Mode**: Press this key to switch the trigger mode to Auto, Normal or Single. The currently selected trigger mode indicator will illuminate.
- **Position** : Trigger level rotary knob, turn clockwise to increase the level,

turn counterclockwise to decrease the level. During the adjustment, the trigger level

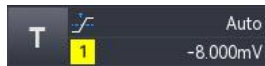

on the top right will change in real-time. When the trigger is single level, press this rotary knob to turn the trigger level to the trigger signal and quickly turn to 50%.

(4) Auto Setting

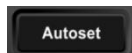

After this key is pressed, the oscilloscope will automatically adjust the vertical scale, scanning time base and trigger mode according to the input to display the most suitable waveform.

Note: When use the waveform automatic setting, if the measured signal is sine wave, it requires its frequency cannot less than 10 Hz and the amplitude should at the range of 12 mVpp ~ 60 Vpp. Otherwise, the waveform automatic setting may be invalid.

(5) Run/Stop



This key is used to set the operating mode of the oscilloscope to “Run” or “Stop”. In the “Run” state, the key is illuminated in green.

In the “Stop” state, the key is illuminated in red.

(6) Single Trigger



This key is used to set the trigger mode of the oscilloscope to “Single”, the key is illuminated in orange.

(7) Clear All

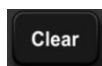

This key is used to clear all the load waveforms. When the oscilloscope is in the “RUN” state, the waveform is continuously refreshed.

(8) Touch/Lock



This key is used to enable/disable the touch screen function. When this key is pressed, the touch screen is enabled and the indicator will be illuminated. When the key is pressed again, the touch screen is disabled and the indicator will be extinguished.

(9) Print Screen



This key is used to quickly copy the waveform on the screen in PNG format to USB.

(10) Multi-purpose Rotary Knob



- **Multipurpose rotary knob**: This key is used to select the digital menu in function pop-up window. When the multi-purpose rotary knob is illuminated, indicating that this key can be used to change the numerical value.

- **Arrow key**: When adjusting the numerical value, this key is used to move the cursor and set the corresponding value.

(11) Function Key



- **Measure** : Press the **Measure** key to enter the measurement menu, to set the counter, voltmeter, parameter snapshot, measurement statistics, add measurement, clear measurement and global setting, and refer to the section of [10. Auto Measurement](#) for more details.

- **Acquire** : Press the **Acquire** key to enter the acquisition setting menu, to set acquire mode, storage mode and interpolation method, and refer

to the section of [13. Sampling System](#) for more details.

- **Cursor** : Press the **Cursor** key to enter the cursor measurement menu, to set time, voltage, screen measurement for each source, and refer to the section of [12. Cursor Measurement](#) for more details.

- **Display** : Press the **Display** key to enter the display setting menu, to set wave display type, grid type, grid brightness, wave brightness, backlight brightness, transparency of pop-up windows, and refer to the section of [14. Display System](#) for more details.

- **Storage** : Press the **Storage** key to enter the storage setting menu, to set storage, load and upgrade. The storage type includes setting, waveform and picture. It can save to local of the oscilloscope or external USB, and refer to [15. Storage](#) for more details.

- **Utility** : Press the **Utility** key to enter the auxiliary function setting menu, to set the basic information, network, WiFi, frp, socket server, rear panel, USB, self-inspection, auto calibration, About, option and Auto, and refer to [17. Utility Function](#) for more details.

- **Gen**: Press the **Gen** key to enter the Gen menu, to set Gen output, and refer to [23. Function/Arbitrary Waveform Generator](#) for more details.

- **APP**: Press the **APP** key to enter the shortcut APP setting box, refer to the section of [24. APP](#).

(12) Home Menu

Press the Home icon on the top right corner to pop up “Home” quick menu, including the quick menu of voltmeter, FFT, signal source, Math, reference, help, cursor, Bode diagram, storage, counter, measurement, regional drawing, display, auxiliary, decoding, search, regional diagram, guide, waveform recording, power analysis and Pass/Fail. Press the quick menu to enter the corresponding function module.

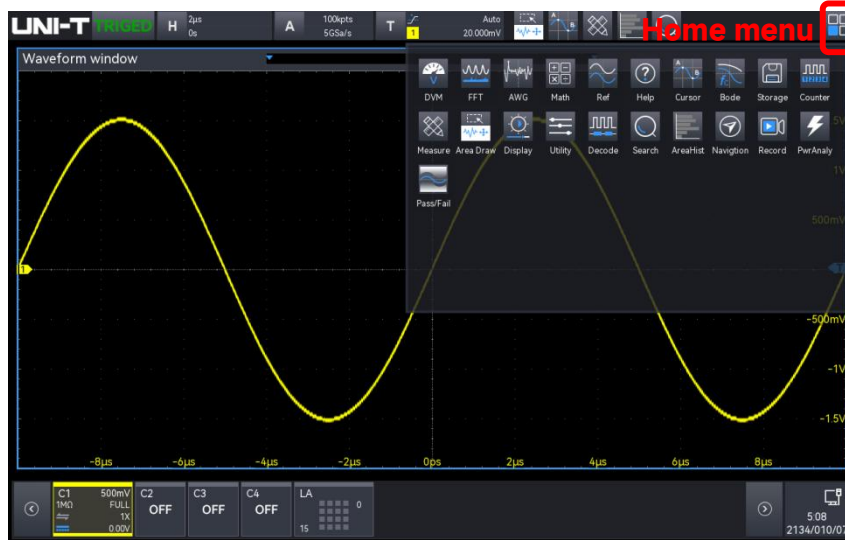

5.6. User Interface

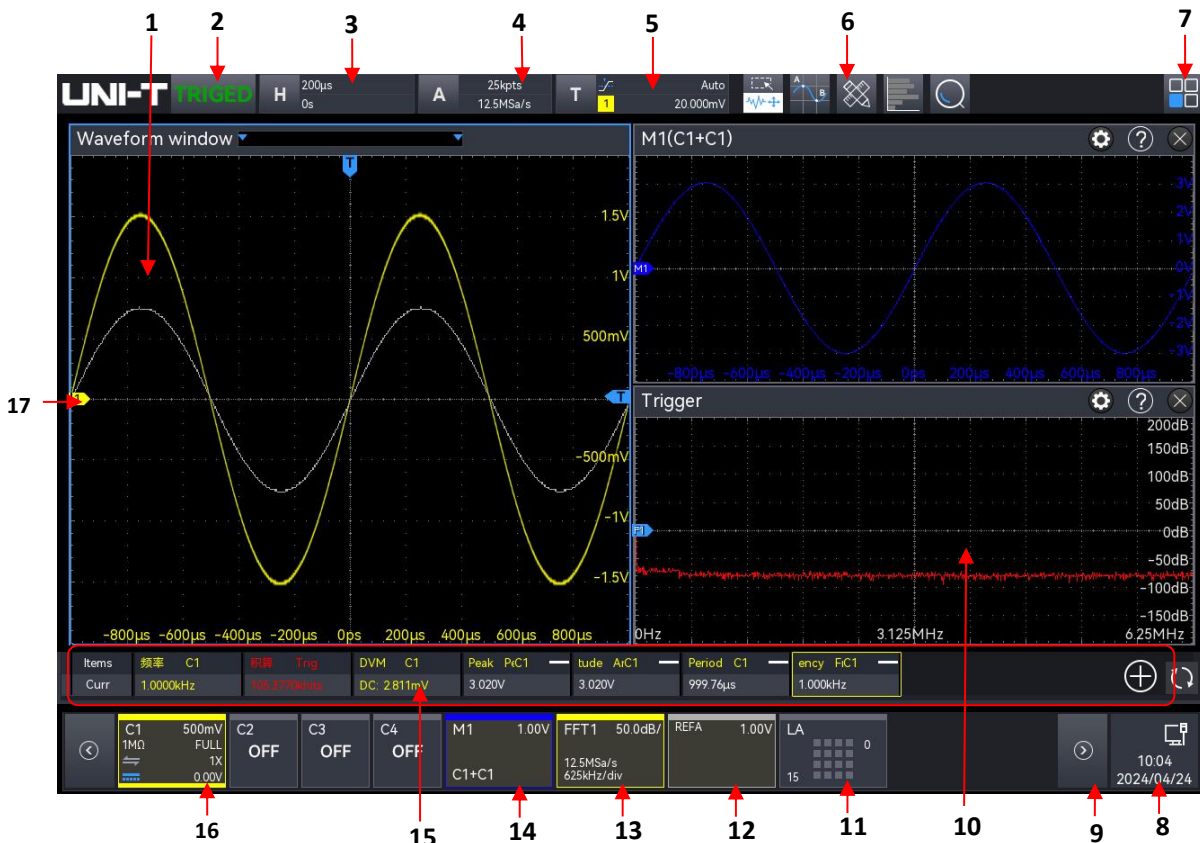

1. Display CH1~CH4 waveform measurement window, Ref waveform and Math waveform.

2. Trigger state: TRIGED, AUTO, READY, STOP, ROLL).
3. Time base label: Display the current horizontal time base, click to enter the horizontal setting menu.
4. Sampling rate and storage depth: Display the current sampling rate and storage depth, click to enter the horizontal setting menu.
5. Trigger info bar: Display the trigger information, including the trigger type, trigger source, trigger level and trigger mode, click the label to pop up the "Trigger Setting" window.
6. Function toolbar: Display the currently added function in toolbar, touch an icon to enter the corresponding function menu. A maximum of 9 icons can be displayed.
7. Home menu: Open the function guide menu, to click each function key to enter the corresponding menu.
8. Notification: Display USB, LAN connecting icon, WiFi and time, click this area to open the setting menu.
 - USB : When the instrument detects a USB is connected, a USB icon is displayed in this area.
 - LAN, WiFi: When LAN is successfully connected, a LAN and WiFi icon is displayed in this area.
 - Time: Display the system time, and refer to the section of Time Setting [Time Setting](#) for more details.
9. Volts/div signal bar: When the volts/div has multiple info box at the bottom of the screen, press this key  to move to left/right to show the hidden box.
10. Multiple window display area: This area can display the function windows of several functions at the same time.
11. Digital label: Display the switch state of digital channel, the open channel will be highlighted, click to open digital setting menu.
12. Ref label: Display the switch state of Ref1~Ref4 and vertical scale, it can display 4 Ref labels.
13. FFT label: Display the switch state of FFT1~FFT4, vertical scale, sampling rate and the frequency of each div. It can display 4 FFT labels.
14. Math label: Display the switch state of Math1~Math4, vertical scale and operation type. It can display 4 Math labels.
15. Measured result display window: Display the results of each measurement and statistics, click on "Measure" to turn on/off the results window.
16. Channel label: Display the switch state of CH1~CH4, vertical scale, impedance, bandwidth limitation, channel coupling, reversed phase, probe multiplying ratio and vertical bias.

17. Analog channel icon: Display the icon of CH1~CH4, the channel icon is the same as the waveform's color.

5.7. Touch Screen

MSO2000X/3000X series provides 10.1 inch super capacitive touch screen, multiple point touch control and gesture control. MSO2000X/3000X has easily operating system with flexible and high sensitive touch screen features for great waveform display and excellent user experience.

Touch control function includes tap, squeeze, drag and rectangle drawing.

Tip: The menu displayed on the screen of the oscilloscope can all use the touch control function.

(1) Tap

Use one finger to slightly tap on an icon or a word on the screen as shown in the following figure.

Tap gesture can use for:

- Tap the menu display on the screen and then to setup
- Tap the function icon on the top right corner to open the corresponding function
- Tap the pop-up numeric keyboard to set the parameter
- Tap the virtual keyboard to set the label name and file name
- Tap a message to pop up a close button on the top right corner to close the pop-up window.
- Tap other window displayed on the screen and then to setup



Tap Gesture

(2) Squeeze

Squeeze two fingers together or separate. Squeeze gesture can zoom out or zoom in the waveform. If the waveform need to zoom out, squeeze two finger together and then slide away; If the waveform need to zoom in, separate two fingers and then squeeze two fingers together as shown in the following figure.

Squeeze gesture can use for:

- Adjust the horizontal time base of waveform by squeezing on the horizontal direction
- Adjust the vertical time base of waveform by squeezing on the vertical direction

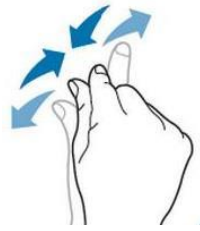

Squeeze Gesture

(3) Drag

Use one finger to press and drag the selected item to the aimed position as shown in the following figure.

Drag gesture can use for:

- Drag the waveform to change the waveform position
- Drag the window to change the window position
- Drag the cursor to change the cursor position



Drag Gesture

(4) Rectangle Drawing

Open the Home menu and click the icon “Rectangle Drawing” to enable the function, drag your finger to draw a rectangle on the screen as shown in Figure (a), (b), move the finger, a menu will appear on the screen, at this point, “Region A”, “Region B”, “Intersection”, “Non-intersect” can be selected. Drag your finger from bottom right to the top left on the screen to draw the trigger area.

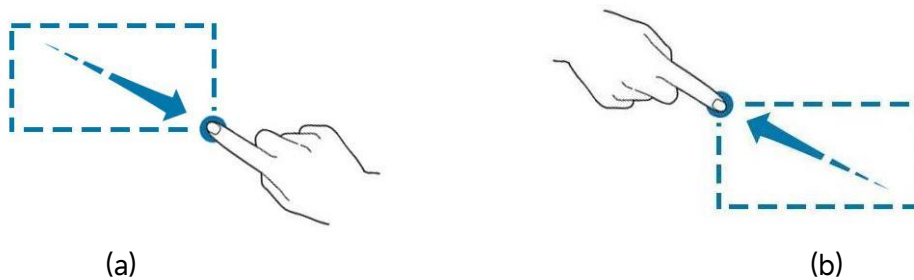



Drawing Gesture

Select “Region A”:

- Draw the trigger region A
- Open the trigger region A
- Open “Region trigger” menu

Select “Region B”:

- Draw the trigger region B
- Open the trigger region B;
- Open "Region trigger" menu

Tips : Click on "rectangle drawing" to step through rectangle drawing and operating waveform mode. Click on "rectangle drawing", if the icon shows , it means that "rectangle drawing" mode is enabled; if the icon shows , it means that "operating waveform" mode is enabled.

5.8. Parameter Setting

MSO2000X/3000X series supports use the Multipurpose rotary knob and touch screen to set the parameter, the setting steps as follows.

(1) Multipurpose rotary knob

For the parameter of time and voltage, once the parameter is selected, rotating the Multipurpose rotary knob on the front panel to enter the parameter value.

(2) Touch screen

Once the parameter or text field has been selected, double-click to pop up the virtual keyboard to enter the parameter value, label name or file name.

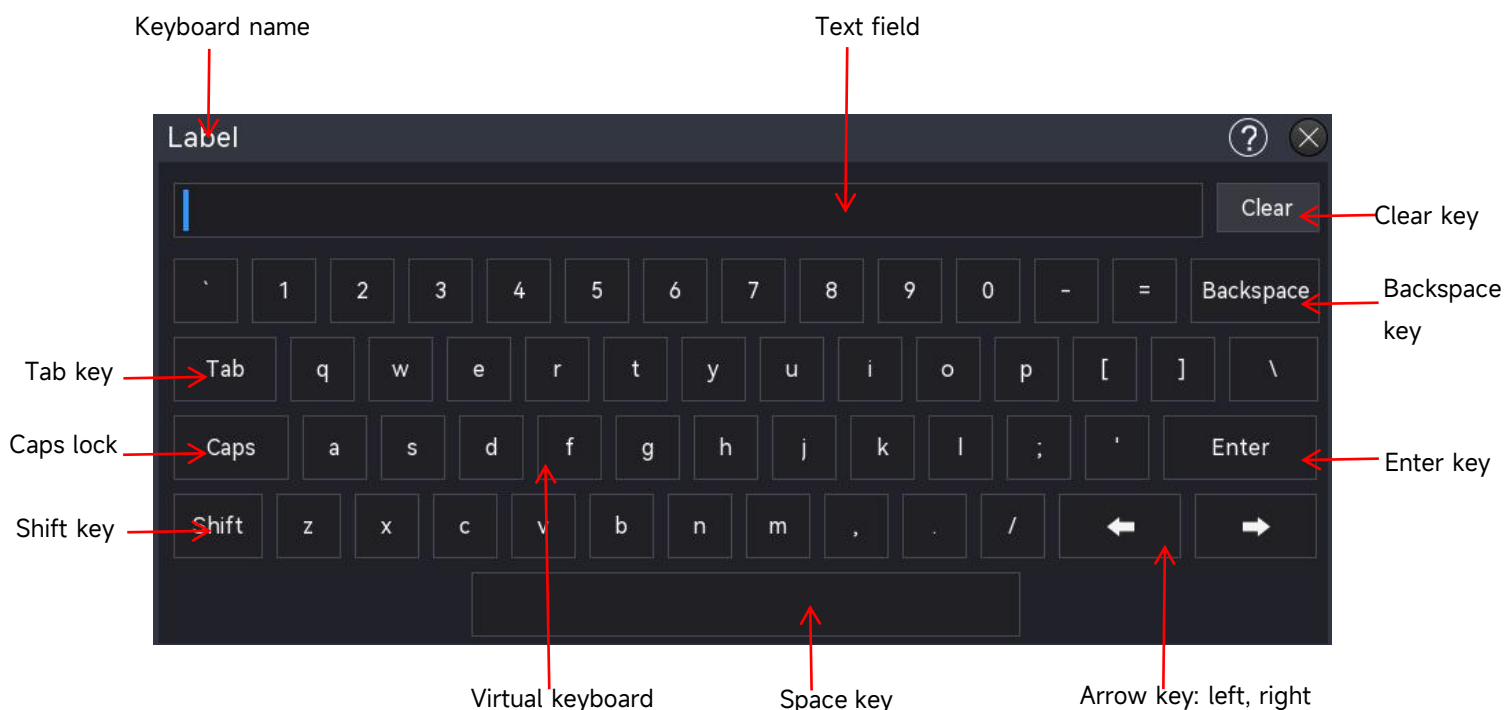

1. Enter character string

When renaming the file or file folder, use the figure keyboard enter a string of characters.



a. Text field

Enter text: letter, number, special character, the length up to 16 characters.

- b. Clear key
Press the "Clear" key to delete all content in the text field.
- c. Caps key
Press the "Caps" key to switch between upper and lower case.
- d. Tab key
Press the "Tab" key to enter 2 spaces at a time.
- e. Shift key
Press the "Shift" key to switch among number, special character, upper and lower case.
- f. Arrow key (left, right)
If part of the content needs to be changed, press the ", " key to move the cursor to left or right and then to edit the content.
- g. Space key
Press the "Space" key to enter one space in the text field.
- h. Backspace key
Press the "Backspace" key to delete a single character. This is used to delete a character when the text field a lot of content
- i. Enter key
Once the content has been entered, press the "Enter" key to confirm the setting and close the virtual keyboard.

2. Enter numeric value

When setting or editing a parameter, use the numeric keyboard to enter the numeric value.

- 1. Click the number or unit to enter

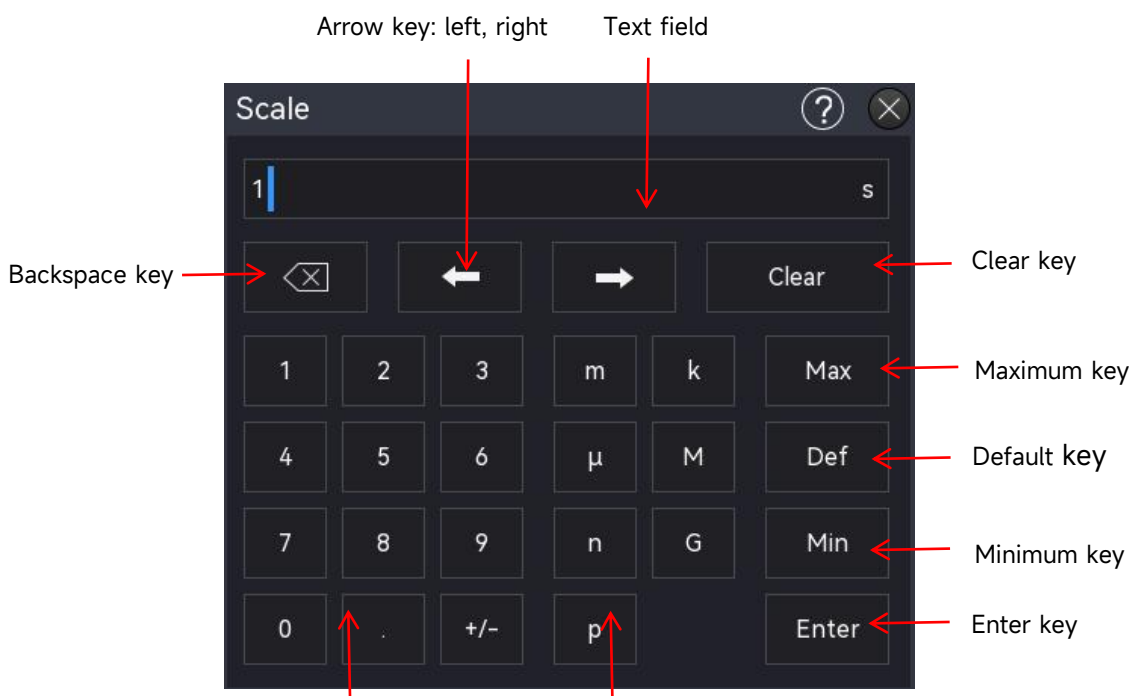

Once all the numeric value and unit have been entered, the numeric keyboard will automatically turn off, that means the parameter setting is completed. In addition, when the numeric value is entered, you can directly click on the “Enter” key to close the numeric keyboard, the unit of parameter will be set by default. You can also use the numeric keyboard to process the setting as follows.

- a. Delete the parameter value that has been entered
 - b. Set the parameter to Max or Min (sometimes, it refers specifically to the maximum or minimum value in the current state)
 - c. Set the parameter to default value
 - d. Clear the text field of parameter
 - e. Move the cursor to edit the parameter value
3. Enter binary, hexadecimal system value

During the decoding trigger, use the numeric keyboard to enter the binary, hexadecimal system value for data and address settings.

Enter method: Tap to select the number or the numeric to be edited in the text field, and then select the numeric or letter in the numeric keyboard to enter.



Once all the numeric value has been entered, press the “Ok” key , the numeric keyboard will automatically switch off, that means the parameter setting is completed. You can also use the numeric keyboard to process the setting as follows.

- a. Move the cursor to edit the parameter value
- b. Set the parameter to Max or Min (sometimes, it refers specifically to the maximum or

- minimum value in the current state)
- c. Set the parameter to default value
- d. Clear the text field of parameter
- e. Delete the parameter value that has been entered

5.9. Remote Control

MSO2000X/3000X series mixed signal oscilloscopes can communicate with a PC via USB and LAN port for remote control. The remote control is implemented on the basis of the SCPI (Standard Commands for Programmable Instruments).

MSO2000X/3000X series has three methods for remote control.

(1) Custom Programming

The user can perform the programming control on the oscilloscope through SCPI (Standard Commands for Programmable Instruments). For detailed descriptions on command and programming, please refer to MSO2000X/3000X Series Mixed Signal Oscilloscope-Programming Manual.

(2) PC Software Control (Instrument manager)

The user can use a PC software to remotely control the oscilloscope. The instrument manager can display the oscilloscope screen in real time, and control the operation with the mouse. It is recommended to use the PC software provided by UNI-T. It can be downloaded from UNI-T official website (<https://www.uni-trend.com>).

Operating steps:

- Setup the communication between the instrument and a PC
- Open the instrument manager software and search the instrument source
- Right-click to open the oscilloscope, operate the instrument manager to remotely control the oscilloscope (refer to Instrument Manager-User's Manual for more details)

(3) Web Control

Once the network is connected, use IP to open the Web. Log in to the Web to remotely control the oscilloscope. Web Control can display the oscilloscope screen in real time. It supports login from PC, mobile phone and iPad, and the network can use intranet or outer net. The user name and password are "admin" and "uni-t".

6. Vertical Channel Settings

- [Open/Activate/Close Analog Channel](#)
- [Vertical Scale](#)
- [Offset](#)
- [Channel Coupling](#)
- [Bandwidth Limitation](#)
- [Probe Setting](#)
- [Reversed Phase](#)
- [Impedance](#)
- [Unit](#)
- [Label](#)

MSO2000X/3000X provides a separate vertical control system for each channel. The setup method of the vertical system for each channel is exactly the same, and this chapter introduces the vertical channel setting using MSO3000X CH1 as an example.

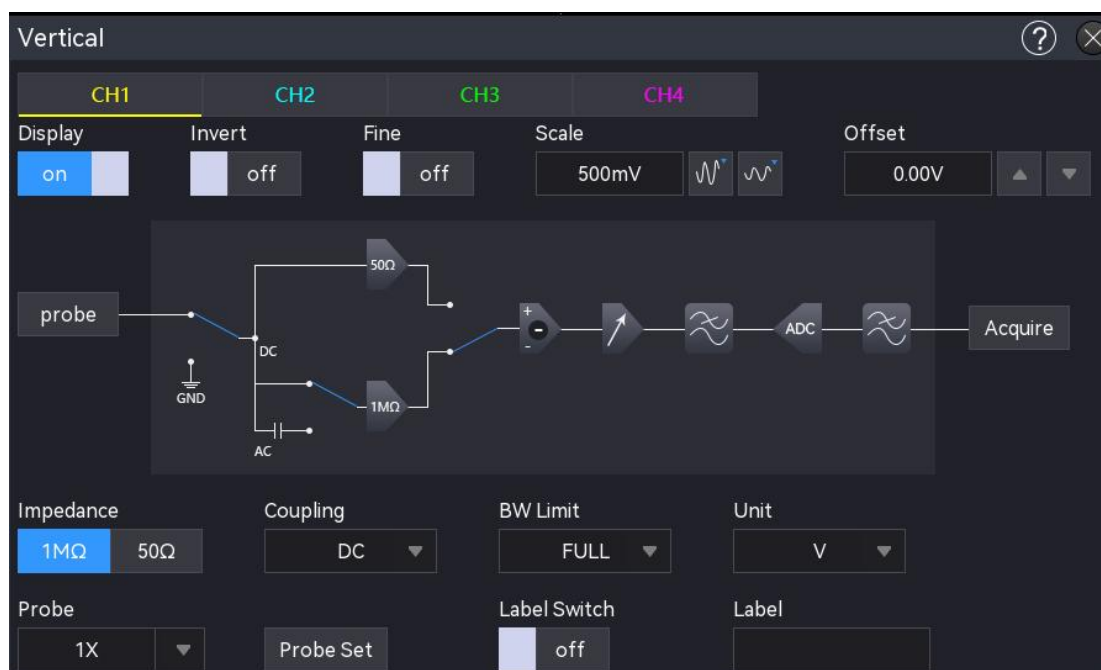

Vertical Channel Setting Menu

6.1. Open/Activate/Close Analog Channel

CH1 ~ CH4 analog channel contains three kinds of state, open, close and activated.

(1) Open the analog channel

- When an analog channel is turned off, click on the channel key **1** on the front panel to turn on CH1 and the indicator will be illuminated.
- Tap on the channel label at the bottom of the screen to turn on CH1.
- In "Channel Setting" menu, select "CH1" to set ON to turn on CH1, select "CH1" to set OFF to turn off CH1.

(2) Close the analog channel

- When CH1 is opened and in the activated state, press the channel key **1** on the front panel or tap on the channel label at the bottom of the screen to turn off CH1.
- When CH1 is opened but not in the activated state. CH1 should be activated at first, and then press the channel key **1** on the front panel or tap on the channel label at the bottom of the screen to turn off CH1.
- Open the "Channel Setting" menu, select "CH1" to set OFF to turn off CH1.

(3) Activate the analog channel

When multi-channel are opened at the same time, but only one channel is activated (the channel can only be activated in the open state), the vertical scale, vertical position and channel setting of the activated channel can be set.

- Press the channel key **1** on the front panel to activate CH1.
- Tap on the channel label at the bottom of the screen to activate CH1.
- Open the "Channel Setting" menu, select "CH1" to set ON and to activate CH1.

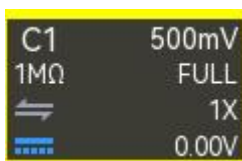

Activated State

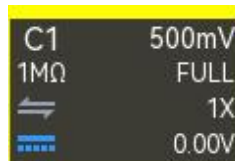

Open but not Activated





Off State

6.2. Vertical Scale

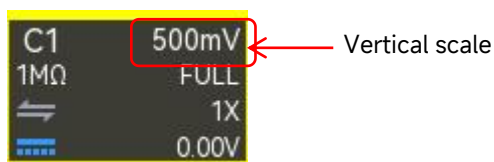
The vertical scale is the voltage value of each grid in the vertical direction, usually expressed as V/div. When adjusting the vertical scale, the amplitude of waveform will increase or decrease, and the scale in the channel label at the bottom of the screen will change in real time (as shown in the following figure).



The range of the vertical scale is related to the currently set probe and the input impedance. The default probe ratio is 1X. When the input impedance is 1 MΩ, the range of vertical scale is 500 uV/div ~ 10 V/div; When the input impedance is 50 Ω, the range of vertical scale is 500 uV/div ~ 1 V/div. When CH1 is in the activated state, the vertical scale can be set by the following steps.

- Use the vertical Scale rotary knob on the front panel to set the vertical scale, clockwise: decrease scale, anticlockwise: increase scale
- Use squeeze gesture to set the vertical scale
- Open the “Channel Setting” menu, select CH1, double-click on the “Vertical Scale” menu to pop up the numeric keyboard to enter the scale value, rotate the Multipurpose rotary knob to adjust the scale value, and then right-click on the icon ,  on the right to adjust the scale value.

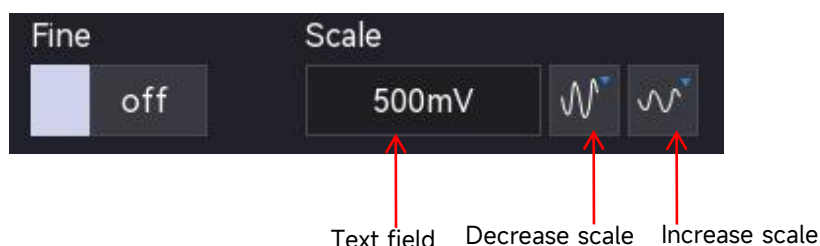

In the “Channel Setting” menu, the adjustment method can set to “Coarse tuning” or “Fine tuning”. “ON” indicates coarse tuning, “OFF” indicates fine tuning. The default is coarse tuning. Press the vertical Scale rotary knob on the front panel can switch between “Coarse tuning” and “Fine tuning”.

- Coarse tuning: Set the vertical scale by the step of 1-2-5 within the range.
- Fine tuning: Change the vertical scale by the step of 1% within the current vertical scale range. If the current scale is 100 mV, when the vertical scale is fine-tuned to 50 mV, adjust with 1 mV; when the vertical scale is fine-tuned to 200 mV, adjust with 2 mV.

6.3. Offset

The vertical offset indicates that the offset of the channel signal zero position of a waveform relative to the center of the screen in the vertical direction. When adjusting the vertical offset, the waveform of a channel will move up and down, and the vertical offset in the channel label at the bottom of the screen will change in real time (as shown in the following figure). The range of the vertical offset is related to the current input impedance, probe ratio and the vertical scale.



When CH1 is in the activated state, the vertical offset can be set by the following steps.

- Open the “Channel Setting” menu, select CH1 and select “Offset” to pop up the numeric keyboard to enter the offset value.
- Click on the “Offset” text field, rotate the Multipurpose rotary knob on the front panel to set the vertical scale.
- Press the icon \uparrow , \downarrow on the right side to adjust the offset value.
- Double-click on the “Offset” text field to pop up the numeric keyboard to directly enter the offset value. For details on the use of the numeric keyboard, refer to the section of [5.8 Parameter Setting](#).

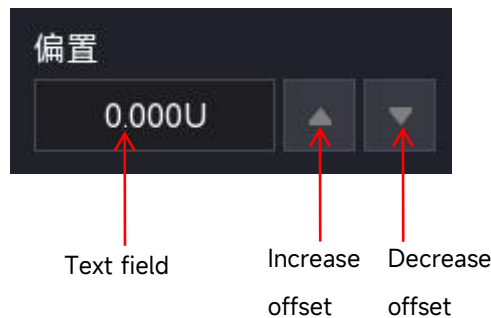

6.4. Channel Coupling

The channel coupling is used to filter out unwanted signals. For example, the measured signal is a signal containing DC offset.

Click the channel label at the bottom of the screen to pop up the “Channel Setting” menu, and then click on “Coupling” to select the coupling mode.

- When the coupling mode is “DC”, the measured signal containing DC component and AC component can all be passed through.
- When the coupling mode is “AC”, the measured signal containing DC component will be blocked
- When the coupling mode is “Ground”, the measured signal containing DC component and AC component will all be blocked.

Once the channel coupling is set, the channel coupling mode will display in the channel label at the bottom of the screen, as shown in the following figure.

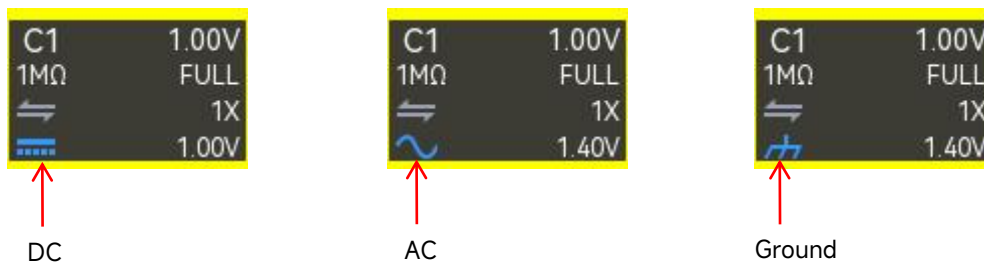

6.5. Bandwidth Limitation

The bandwidth limitation is used to decrease the noise in the waveform. It mainly used to reduce high-frequency noise in a signal when observing low-frequency signals. For example, the measured signal is a pulse signal containing high-frequency oscillation.

Click the channel label at the bottom of the screen to pop up the “Channel Setting” menu, and then click on “Bandwidth Limitation” to select the value of bandwidth limitation. When the bandwidth limitation is enabled, the value of bandwidth limitation will display in the channel label at the bottom of the screen, as shown in the following figure.



MSO2000X/3000X series can set the bandwidth limitation to 20 MHz or FULL.

- 20 MHz: When the measured signal contains the high-frequency that greater than 20 MHz, it will be attenuated.
- FULL: The measured signal containing the high-frequency can be passed through.

6.6. Probe

This oscilloscope supports common passive probe. To match the probe attenuation coefficient setting, the probe multiplying ratio should be set in the “Channel Setting” menu.

Click the channel label at the bottom of the screen to pop up the “Channel Setting” menu, and then click on “Probe multiplying ratio” to set.



Probe multiplying ratio: 0.001X, 0.01X, 0.1X, 1X, 10X, 100X, 1000X, custom.

When the channel unit is A, it is the current probe and can set to 5mV/A, 10mV/A, 50mV/A, 100mV/A, 200mV/A, 5000mV/A, 1V/A or custom.

6.7. Reversed Phase

Click the channel label at the bottom of the screen to pop up the “Channel Setting” menu, and then click on “Reversed Phase” to switch on/off. When the reversed phase is enabled, an icon  in the channel label will be illuminated.



When the reversed phase is disabled, the waveform is displayed normally. When the reversed phase is enabled, the waveform voltage will be reversed, and the results of math operation and waveform measurement will also be changed, as shown in the following figure.



Reversed Phase: ON

Reversed Phase: OFF

6.8. Impedance

To reduce the electric load cause by the interaction of the oscilloscope and the circuit to be measured, this oscilloscope provides two input impedance mode 1 MΩ (default)and 50 Ω. In the “Channel Setting” menu, click on “Impedance” to select the input impedance to1 MΩ or 50 Ω.

- 1 MΩ: The input impedance of oscilloscope is extremely high at this time, so the current flowing into the oscilloscope from the measured circuit can be ignored.
- 50 Ω: Match the oscilloscope to a device with an output impedance of 50 Ω.

The circuit diagram in the “Channel Setting” menu will change with the input impedance, as shown in the following figure.

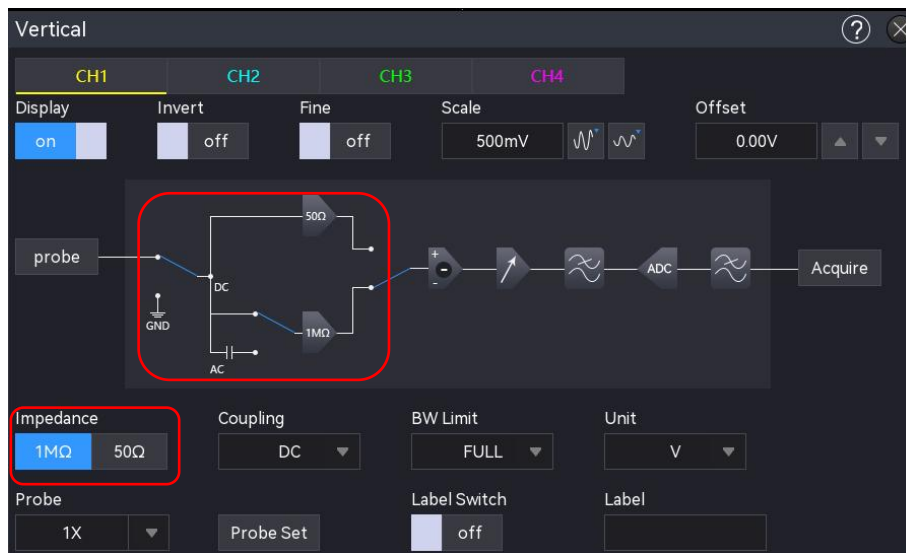

Change of Input Impedance

- The input impedance setting will affect the range of the channel's vertical scale and vertical offset.

6.9. Unit

Click the channel label at the bottom of the screen to pop up the “Channel Setting” menu, and then click on “Unit” to set the unit to “V”, “A”, “W” or “U”. The default unit is V. When using the current probe, the unit switches to “A”. Once the unit is set, the unit in the channel label and the measurement unit will also be changed.

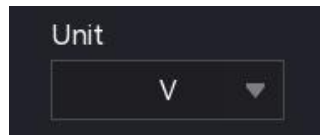

6.10. Label

The instrument uses the channel number to identify the channel by default, but you can set a different name for each channel to suit your preferences. For example, CH1.

Click the channel label at the bottom of the screen to pop up the “Channel Setting” menu, and then click on “Label” to select display (ON) or not display (OFF) the channel label. The channel label can also be set by double-click on the text field to pop up the virtual keyboard to directly enter the character string. For details on the use of the virtual keyboard, refer to the section of [5.8 Parameter Setting](#).

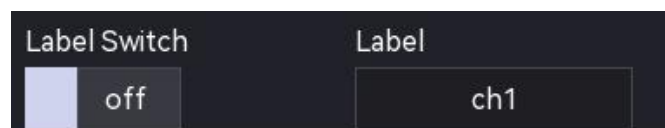

7. Horizontal System

- [Horizontal Scale](#)
- [Horizontal Extension](#)
- [ROLL Mode](#)
- [Delay Sweep](#)
- [Window Extension](#)
- [XY](#)
- [Horizontal Position](#)

Enter the horizontal control system by the following steps.

- Press the **Menu** key to enter "Horizontal" menu.
- Tap the horizontal label on the top to enter "Horizontal" menu.

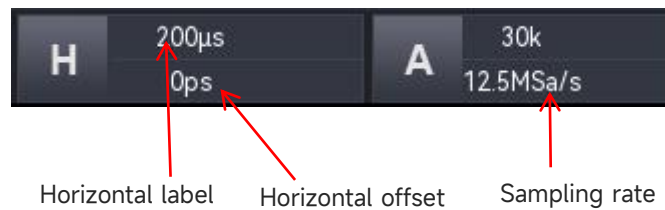

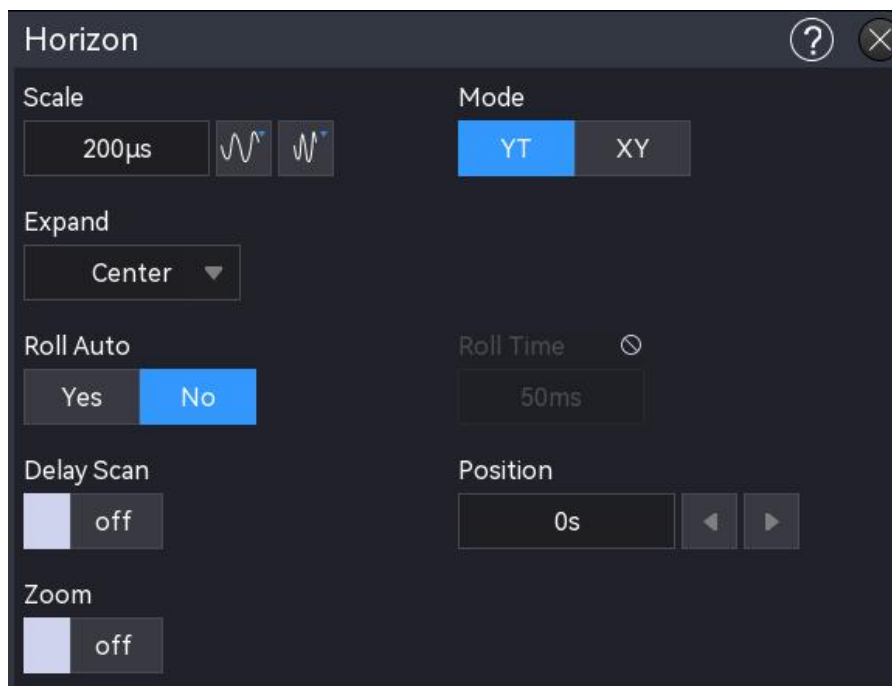

7.1. Horizontal Scale

The horizontal scale is also known as the horizontal time base, i.e., the time value represented by each scale in the horizontal direction of the screen, usually expressed as s/div. The range of horizontal scale as shown in the following table. When adjusting the horizontal time base, it changes in step of 1-2-5, i.e. 500 ps/div, 2 ns/div, 5 ns/div.....500 s/div, 1 ks/div.

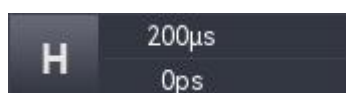

Model	Range
MSO2304X	1 ns/div ~ 1 ks/div
MSO2204X	2 ns/div ~ 1 ks/div
MSO2104X	5 ns/div ~ 1 ks/div
MSO3054X	500 ps/div ~ 1 ks/div
MSO3034X	1 ns/div ~ 1 ks/div

When the horizontal time base is changed, the waveform of all channel will be horizontally extended or compressed with respect to the currently selected horizontal extension reference (see horizontal extension), and the horizontal time base on the top left will change in real time (as shown in the following figure).





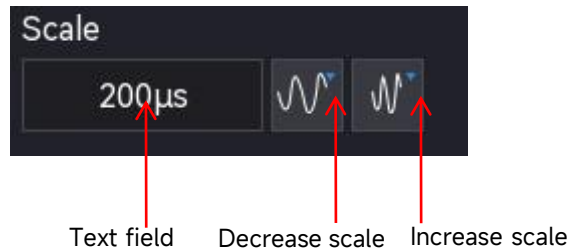

The horizontal time base can be set by the following steps.

- Use the horizontal Scale rotary knob on the front panel to set the vertical scale, clockwise: decrease scale, anticlockwise: increase scale

- Use squeeze gesture to set the horizontal scale
- Tap the horizontal scale label on the top to enter “Horizontal” menu, double-click on the “Horizontal Scale” text field to pop up the numeric keyboard to directly enter the scale value. For details on the use of the numeric keyboard, refer to the section of [5.8 Parameter Setting](#). Rotate the [Multipurpose rotary knob](#) to adjust the scale value, and then right-click on the icon ,  on the right to adjust the scale value.



MSO2000X/3000X series supports horizontal adjustment, press the horizontal [Scale](#) rotary knob on the front panel can switch between “Coarse tuning” and “Fine tuning”.

- Coarse tuning: Click the icon ,  on the right to adjust the horizontal scale, the horizontal time base of each channel's waveform will be adjusted in step of 1-2-5 within the range.
- Fine tuning: Click the icon ,  on the right to further adjust the horizontal scale, the horizontal time base of each channel's waveform can be adjusted in small step within the range.

7.2. Horizontal Extension

The horizontal extension refers to the reference position for horizontal extension and horizontal compression when adjusting the horizontal time base. In “Horizontal” menu, select “Horizontal Extension” to set the reference position to “Center”, “Left”, “Right”, “Trigger point” or “Custom”. The default is “Center”.

- Center: When adjusting the horizontal time base, the waveform is expanded or compressed horizontally around the center of the screen.
- Left: When adjusting the horizontal time base, the waveform is expanded or compressed horizontally around the far left.
- Right: When adjusting the horizontal time base, the waveform is expanded or compressed horizontally around the far right.
- Trigger point: When adjusting the horizontal time base, the waveform is expanded or compressed horizontally around the trigger point.
- Custom: When adjusting the horizontal time base, the waveform is expanded or compressed horizontally around the custom reference position. Once “Custom” is selected, click on the “Custom Extension” test field to pop up the numeric keyboard to enter the reference position

for horizontal extension. The range is -500 ~ 500 and the default is 0.

7.3. ROLL Mode

Click on the “Roll Mode” menu, to set whether to enter SCAN or ROLL when the current time base is slower than the fastest roll time base. It can be set to “Yes” or “No”.

- Yes: When the time base is slower than the fastest roll time base, the oscilloscope will enter the ROLL mode. In this mode, the oscilloscope continuously draws the voltage-time tendency of the waveform on the screen. The waveform is refreshed from right to left and the latest waveform is drawn on the far right.

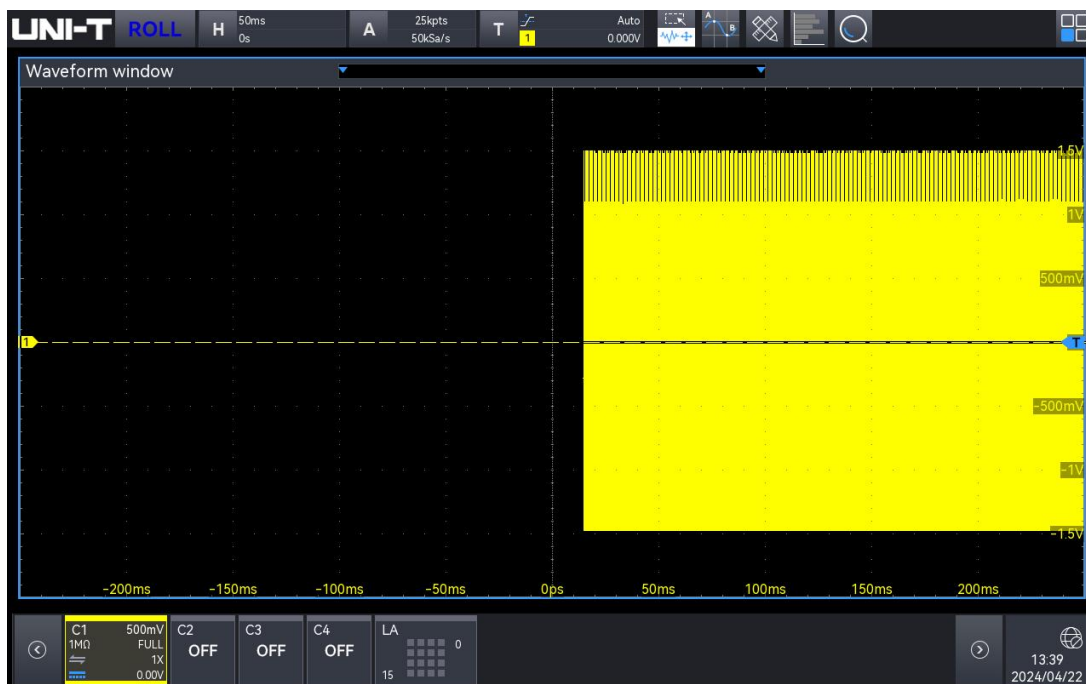

- No: When the time base is slower than the fastest roll time base, the oscilloscope will not enter the ROLL mode and will be in SCAN state. In the SCAN state, the oscilloscope enters the slow sweep mode. When using the slow sweep mode to observe the low-frequency signal, it is recommended that the channel coupling is set to DC. In this mode, the waveform is refreshed from left to right and the latest waveform is drawn on the far left.

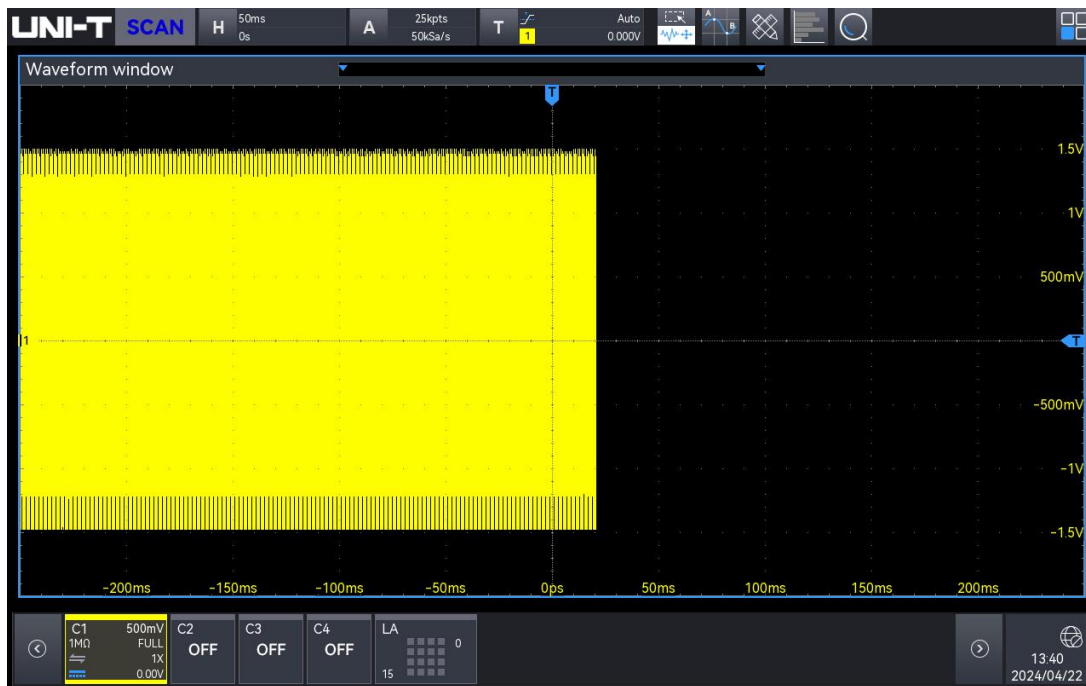

7.4. Fastest Roll Time Base

Double-click on the “Fastest Roll Time Base” text field, to enter “ROLL” or “SCAN” time base.

The fastest roll time base can be set by the following steps.

- Press the Multipurpose rotary knob on the front panel to change the value, clockwise: decrease, anticlockwise: increase.
- Double-click on “Fastest Roll Time Base” text field to pop up the numeric keyboard to directly enter the value. For details on the use of the numeric keyboard, refer to the section of [5.8 Parameter Setting](#).

7.5. Delay Sweep

The delay sweep is used to horizontally enlarge a waveform to allow the user to check the waveform details. In the “Horizontal” menu, select “Delay Sweep” to set ON or OFF. Once the delay sweep is enabled, the scale and offset of the delay sweep can be set.

7.6. Horizontal Position

Tap on the “Horizontal Position” text field to change its value. Set the horizontal center as the zero point, the waveform will move to the left if the horizontal position is greater than 0; the waveform will move to the right if the horizontal position is less than 0.

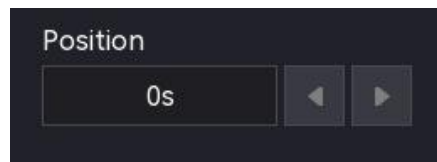

The horizontal position can be set by the following steps.

- Press the Multipurpose rotary knob on the front panel to adjust the horizontal position, clockwise: decrease, anticlockwise: increase.
- Press the horizontal Position rotary knob to adjust its value, clockwise: decrease, anticlockwise: increase.
- Double-click on “Horizontal Position” text field to pop up the numeric keyboard to directly enter the value. For details on the use of the numeric keyboard, refer to the section of [5.8 Parameter Setting](#).
- Click on the icon “◀▶” on the right to adjust the horizontal position.

7.7. Window Extension

The window extension is used to horizontally enlarge a waveform to check more details. It can help the user to learn more about the signal. The window extension can be opened by the following steps.



- Tap the horizontal label on the top to open the “Horizontal” menu, click on “Extension Time Base” to switch on/off. ON: turn on the Extension Time Base. OFF: turn off the Extension Time Base.

Time base

When the window extension is enabled, “Extension Time Base” and “Main Time Base” can be set.

- a. Extension Time Base: Rotate the horizontal Scale rotary knob to change the Extension Time Base only.
- b. Main time base: Rotate the horizontal Scale rotary knob to change the main time base only.

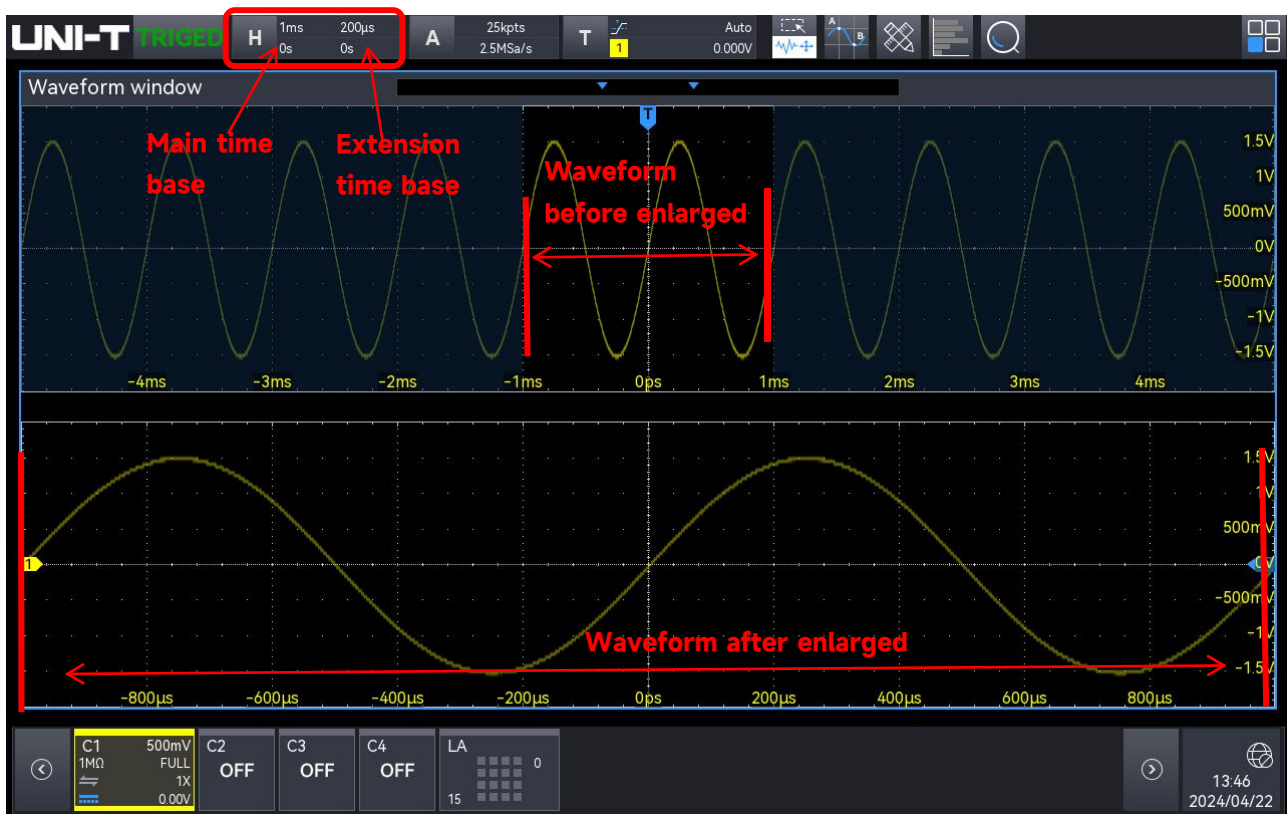

Waveform before enlarged

The enlarged waveform without shadow is displayed in the upper part of the screen, this area can be moved by using the horizontal Position rotary knob or by adjusting the horizontal Scale rotary knob to zoom in/out this area.

Waveform after enlarged

The waveform after horizontally enlarged is displayed in the lower part of the screen, the window extension improves the resolution relative to the main time base.

Note: The window extension is only available when the horizontal time base is in the fastest roll time base. When the extension timebase is enabled in the ROLL mode, the main time base will set to the fastest roll time base by default.

7.8. XY

The waveform displayed in XY mode is also called Lissajous curve. XY supports the cursor measurement, it can quickly measure the phase difference between two signals.

(1) Format of time base:

- a. YT: Display the voltage value on time base (horizontal scale).
- b. XY: Display Lissajous curve, it can easily measure the phase difference between two signals with same frequency.

(2) Display: Open XY display, the channel waveform and XY curve are displayed in the split screen.

by default.

(3) X-Y:

Set the waveform to generate a Lissajous curve, which can select C1-C2, C1-C3, C1-C4, C2-C3, C2-C4, C3-C4.

If "X-Y" is set to C1-C2, input CH1 signal on the horizontal axis (X), input CH1 signal on the vertical axis (Y).

In XY mode, when CH1 or CH3 is in the activated state, use the vertical Position rotary knob to move XY curve on the horizontal direction. When CH2 or CH4 is in the activated state, use the vertical Position rotary knob to move XY curve on the vertical direction.

The amplitude of each channel can be changed by using the vertical Scale rotary knob. The time base can be changed by using the horizontal Scale rotary knob, which can get a better display effect of Lissajous curve. The waveform in XY mode as shown in the following figure.

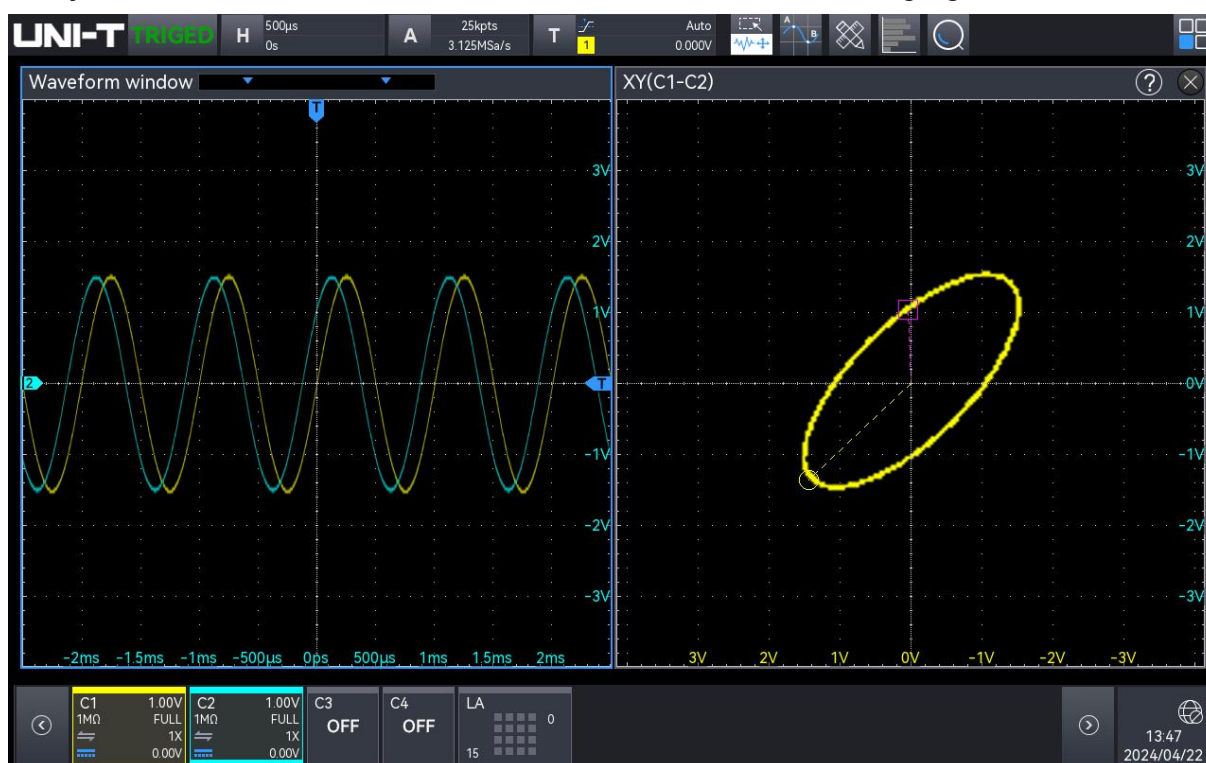

In this state, set the menu to display in split screen, and press the **Cursor** key, as shown in the following figure.

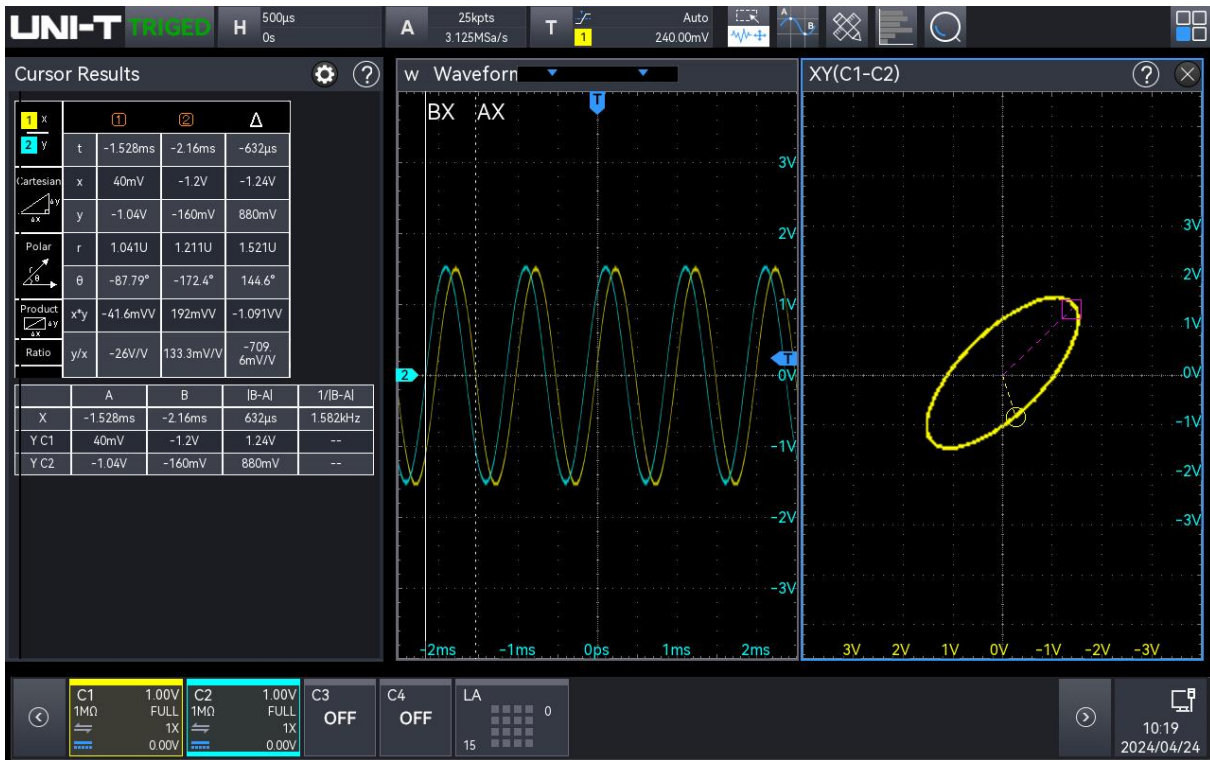

Cursor ①: time, rectangular coordinate, polar coordinate, product and proportion

Cursor ②: time, rectangular coordinate, polar coordinate, product and proportion

△ : Delta (numerical difference between two cursors)

Application of XY mode

Phase difference between in two signals with the same frequency can be easily observed through Lissajous curve. The following figure explains the observation schematic of the phase difference.

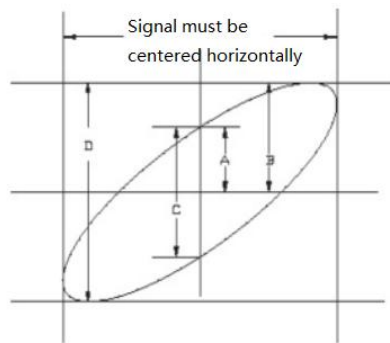

Based on $\sin\theta=A/B$ or C/D , θ is the phase angle between the channels, the definition of A, B, C, D see figure above. So the phase angle is $\theta=\pm\arcsin(A/B)$ or $\theta=\pm\arcsin(C/D)$.

If the main spindle of elliptical within I, III quadrant, then the acquired phase angle should within I, IV quadrant, that is within $(0 \sim \pi/2)$ or $(3\pi/2 \sim 2\pi)$.

If the main spindle of elliptical within II, IV, then the acquired phase angle should within $(\pi/2 \sim \pi)$ or $(\pi \sim 3\pi/2)$

In addition, if the frequency or phase difference of the two signal to be measured are integer times, calculating the frequency and phase relation of the two signals based on the following figure.

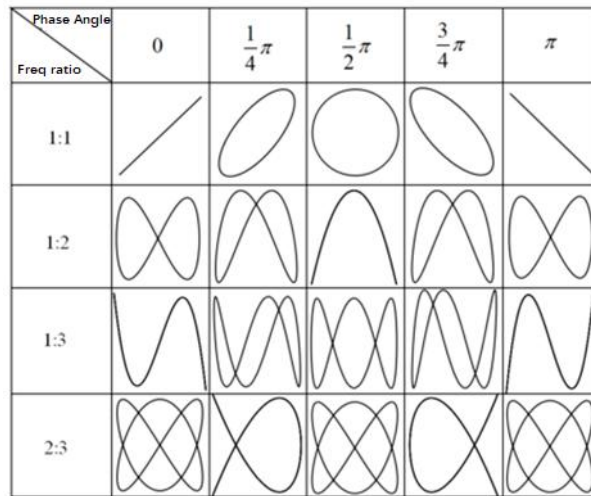

8. Trigger System

- [Noun Explanation of Trigger System](#)
- [Edge Trigger](#)
- [Pulse Width Trigger](#)
- [Video Trigger](#)
- [Slope Trigger](#)
- [Runt Trigger](#)
- [Window Trigger](#)
- [Delay Trigger](#)
- [Timeout Trigger](#)
- [Duration Trigger](#)
- [Setup & Hold Trigger](#)
- [Nth Edge Trigger](#)
- [Code Pattern Trigger](#)
- [RS232 Trigger](#)
- [I²C Trigger](#)
- [SPI Trigger](#)
- [CAN Trigger](#)
- [CAN-FD Trigger](#)
- [LIN Trigger](#)
- [FlexRay Trigger](#)
- [I2S Trigger](#)
- [1553B Trigger](#)
- [Manchester Trigger](#)

- [SENT Trigger](#)
- [ARINC429 Trigger](#)
- [Region Trigger](#)

Trigger refers to set the trigger condition based on the requirements. When a waveform meets a condition, the oscilloscope will immediately captures the waveform and its adjacent part and display it on the screen. Once the oscilloscope is operating, regardless of whether the trigger is stable, it will continuously capture the waveform, but only stable triggers can be displayed.

The trigger ensures that each time base sweep or acquisition starts from a custom trigger condition, that is each scan is synchronized with the acquisition and the acquired waveforms overlap to provide a stable waveform.

The trigger setting should determine when the oscilloscope will acquire and display data based on the characteristics of the input signal. For example, set the trigger to generate on the rising edge of the analogue channel 1 input signal. Therefore, the user should be familiar with the signal under test so that you can quickly acquire the desired waveform.

MSO2000X/3000X series has several advanced Trigger types, including many serial bus triggers. This chapter describes each Trigger type.

Advanced protocol triggered decoding supports models and whether they are standard as shown in the table below:

Option name	Description	Models	Standard/Option
Computer serial bus triggering and analysis	RS-232/422/485/UART	MSO2000X/3000X	Standard
Embedded serial bus triggering and analysis	I2C, SPI	MSO2000X/3000X	Standard
Automobile serial bus triggering and analysis	CAN, LIN	MSO2000X/3000X	Option
Automobile serial bus triggering and analysis	CAN-FD	MSO2000X/3000X	Option
Automobile serial bus triggering and analysis	FlexRay	MSO2000X/3000X	Option
Automobile sensor bus triggering and analysis	SENT	MSO2000X/3000X	Option
Audio serial bus triggering and analysis	I2S、LJ、RJ、TDM	MSO2000X/3000X	Option

Aerospace serial bus triggering and analysis	MIL-STD-1553, ARINC 429	MSO3000X	Option
Wireless communication trigger and analysis	Manchester	MSO3000X	Option

Follow the steps below to access the “Trigger” menu.

- Press the Menu key on the front panel to enter the “Trigger Setting” menu.
- Tap the “T” trigger label on the top (as shown in the following figure) to enter the “Trigger Setting” menu.

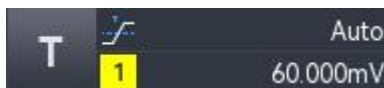

8.1. Noun Explanation of Trigger System

(1) Trigger Source

A signal is used to generate a trigger. Trigger can be obtained from a variety of sources, such as analog channel (CH1, CH2, CH3, CH4), digital signal (D0~D15), external trigger (EXT), mains electricity, etc.

- a. Analog channel: Select any one of the analog signal input port CH1~CH4 on the front panel of the oscilloscope as a trigger signal.
- b. Digital signal: When a digital signal is connected and digital is opened, select any one of the digital channel as a trigger signal.
- c. External trigger: Select the input signal EXT Trig on the rear panel of the oscilloscope as a trigger signal. For example, use the external clock to input to EXT Trig and set it to be a trigger source. When the range is $-7\text{ V} \sim +7\text{ V}$, EXT trigger level can be set.
- d. Mains electricity: It is used to observe the related signal of mains electricity, such as the relation of lighting equipment and power supply equipment, to obtain stable synchronization.

Press the trigger soft key Menu on the front panel or tap the “T” trigger label on the top to open the “Trigger” menu, tap on the “Source” to set it.

(2) Trigger Mode

The trigger mode is used to determine how the oscilloscope behaves during the trigger condition. The following is a brief introduction to the trigger acquisition process of the oscilloscope through the pre-trigger buffer and the post-trigger buffer.

When the oscilloscope is in operation, the pre-trigger buffer is filled first, and perform a trigger search, in the meantime, the data is continuously filled into the pre-trigger buffer, and the

sampled data is transferred to the pre-trigger buffer by FIFO method. After a trigger has been found, the pre-trigger buffer contains the data before the trigger. The oscilloscope then fills the post-trigger buffer and displays the sampled data.

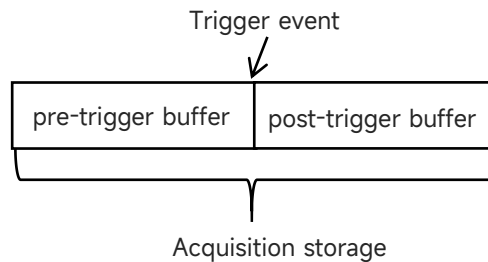

This oscilloscope provides three trigger mode, auto, normal and single. The trigger mode can be set by the following steps.

- Press the **Mode** softkey in the trigger area on the front panel to switch the trigger mode.
- Press the **Menu** softkey in the trigger area on the front panel or tap the “T” trigger label on the top to open the “Trigger” menu to select the trigger mode.
 - a. Auto: When there is no input trigger signal, the oscilloscope will automatically collect and display data. When the trigger signal is generated, the normal mode will automatically turn to sweep mode, thus the signal can be synchronized.

The auto mode is suitable for the following condition.

- Checking DC signal or a signal with unknown electric feature.

Note: In the auto mode, it allow to 50 ms/div or a much slower time base if there is no trigger signal in ROLL mode.

- b. Normal: The oscilloscope can only collect waveform when the trigger condition is satisfied. When there is no trigger signal, the oscilloscope will stop collect data and in the wait state. When the trigger condition is satisfied, the oscilloscope will refresh the current waveform data on the screen, otherwise, it remains the last triggered waveform.

The normal mode is suitable for the following conditions.

- Only collect the specified event appointed by the trigger setting.
- A rare trigger event. The normal mode can prevent the oscilloscope from automatically triggering, so that the waveform can be displayed stably.

- c. Single: In the single trigger mode, press the **Single** key on the front panel once, the waveform on the screen will be deleted and the oscilloscope enters the wait state. When the oscilloscope detects a single trigger, the waveform will be sampled and displayed, and then the oscilloscope enters the STOP state. Press the **Single** key again, the waveform on the screen will be deleted and the oscilloscope will quickly enter the single mode.

The single mode is suitable for the following conditions.

- Capture a single event by accident or non-periodic signal, such as up, down waveform.
- A rare trigger event.

(3) Trigger Coupling

Trigger coupling determines which part of the signal will be transmitted to the trigger circuit. This setting is available only when it is edge trigger and the trigger source is an analogue channel.

Press the  softkey on the front panel or tap the “T” trigger label on the top to enter the “Trigger” menu, click on the “Trigger Coupling” to select the trigger coupling mode (Default: DC).

- a. DC: Let all DC and AC components of the signal pass through
- b. AC: Block the DC component of the signal
- c. HF reject: Attenuate high frequency components over 40 kHz
- d. LF reject: Attenuate low frequency components below 40 kHz

(4) Trigger level

Trigger level is used to confirm the edge position of trigger point, the trigger level is related to the trigger source.

- When the trigger source is CH1~CH4, rotate the Position rotary knob on the right to adjust the trigger level; If the trigger window is opened, tap on the trigger level and then rotate the Multipurpose rotary knob to adjust the trigger level; or double-click on the “Trigger level” text field to pop up the virtual keyboard to set the trigger level. For details on the use of the numeric keyboard, refer to the section of [5.8 Parameter Setting](#). During this process, a trigger level line (the color is consistent with the channel color) and a trigger icon  will appear on the screen, this line will move up and down according to the change of trigger level. Once the adjustment is stopped, the trigger level line will disappear after 2 seconds. The current trigger level is displayed in the trigger label on the screen.

For runt-amplitude trigger, ramp trigger and over-amplitude trigger, high level and low level must be set. If the trigger window is opened, tap on “High” or “Low” and rotate the Multipurpose rotary knob to set the high or low level; or pop up the virtual keyboard to set the trigger level. Two trigger level icons  are displayed on the right.

- When the trigger source is AC Line, it has no trigger level.
- When the trigger source is EXT, rotate the Position rotary knob on the right to adjust the trigger level; If the trigger window is opened, tap on the trigger level and then rotate the Multipurpose rotary knob to adjust the trigger level; or double-click on the “Trigger level” text field to pop up the virtual keyboard to set the trigger level. For details on the use of the numeric keyboard, refer to the section of [5.8 Parameter Setting](#). The current trigger level

is displayed in the trigger label on the screen. For this trigger source, only the trigger level change is displayed, but no trigger level line.

(5) Trigger Holdoff

Trigger holdoff is used to stably generate complex and overlapping waveform (several edges or other events between the overlap waveforms, such as a pulse wave). Trigger holdoff time is the amount of time that the oscilloscope waits for the trigger circuit to restart. During the trigger holdoff, even if the trigger condition is met, the oscilloscope will not trigger until the end of holdoff time. For example, a set of pulse trains that require triggering on the first pulse of the train, then the holdoff time can be set to the width of the pulse train.

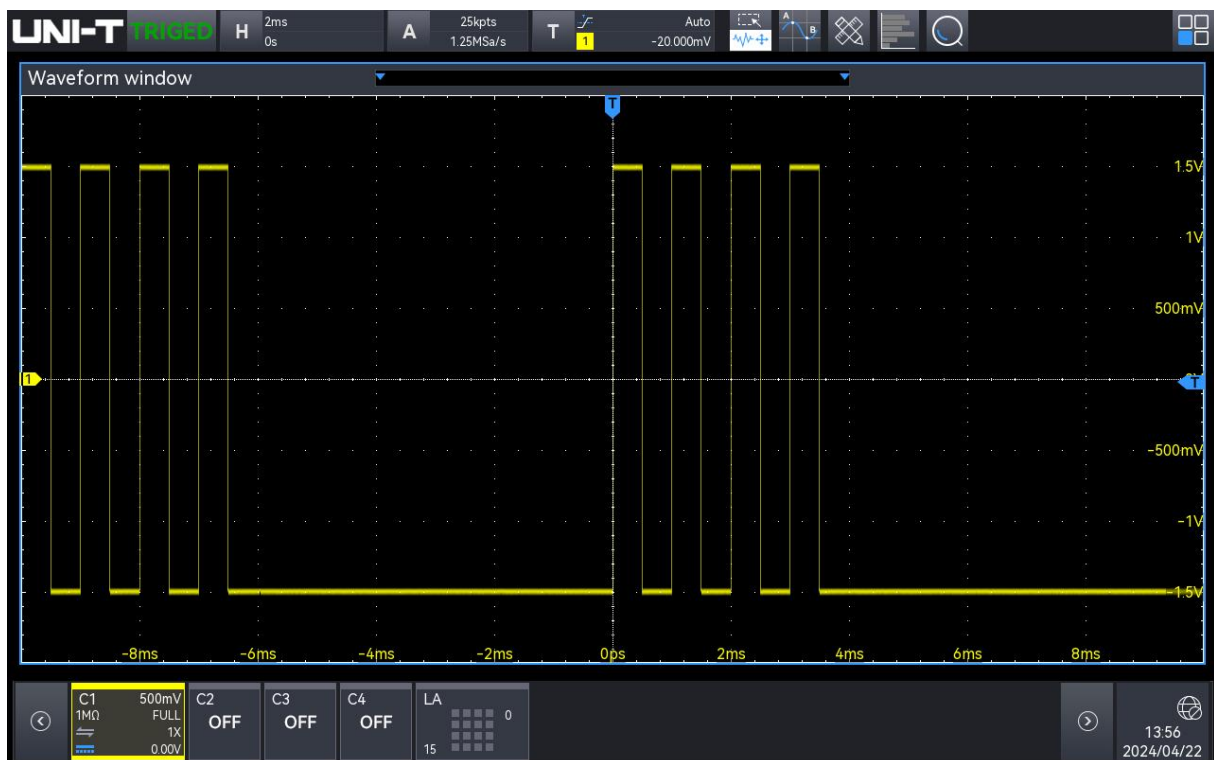

Trigger Holdoff

Press the **Menu** softkey on the front panel or tap the “T” trigger label on the top to enter the “Trigger” menu, click on the “Trigger Holdoff” text field to pop up the numeric keyboard to set the trigger holdoff time (until the waveform is stably triggered, the default is 80 ns). For details on the use of the numeric keyboard, refer to the section of [5.8 Parameter Setting](#). Or rotate the **Multipurpose** rotary knob on the front panel to set the trigger holdoff time. The range can set to 80 ns~ 10 s.

(6) Noise Rejection

Noise rejection is used to attenuate the high-frequency noise in a signal, to reduce the error trigger probability of the oscilloscope. Press the Menu softkey on the front panel or tap the “T” trigger label on the top to enter the “Trigger” menu, click on the “Noise Rejection” to switch

on/off.

(7) Force Trigger

The **Force** key can force to generate a trigger signal.

If the waveform is not displayed on the screen in the “Normal” or “Single” mode, press the **Force** key to collect the signal baseline to confirm that the acquisition is normal.

(8) Pre-trigger/Delay Trigger

The sampled data before trigger event/post-trigger event.

Trigger position is usually set at the horizontal center of the screen. The user can observe 5 grids of pre-trigger and delay information. You can move the waveform horizontally to view more pre-trigger information. By observing the pre-trigger data, the waveform before generated can be observed. For example, capturing the glitch at the start of the circuit, observing and analyzing the pre-trigger data to find out the cause of the glitch.

8.2. Edge Trigger

The edge can be identified by looking for the specified edge (rising edge, falling edge and rising & falling edge) and electrical level. Press the edge trigger menu to set the source, trigger coupling, trigger mode, edge type and trigger level. A stable waveform can be generated when the condition is satisfied.

Press the **Menu** softkey on the front panel or tap the “T” trigger label on the top to enter the “Trigger” menu, click on the “Edge Trigger” to set.

(1) Trigger type

Press the **Menu** softkey on the front panel or tap the “T” trigger label on the top to enter the “Trigger” menu. Tap on the “Trigger type” to select “Edge”.

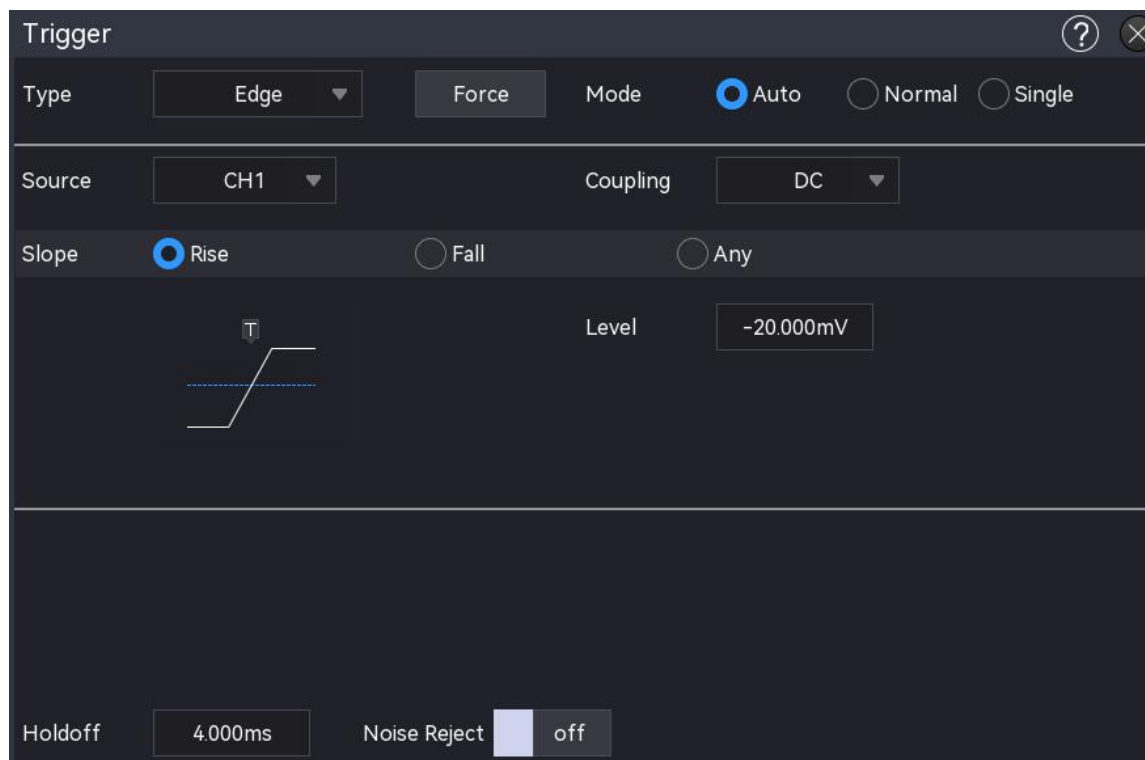

(2) Trigger Mode

Set the trigger mode to auto, normal or single, and refer to the section of [Trigger Mode](#) for more details.

(3) Source

Click on the “Source” to select CH1~CH4, main electricity, EXT or D0~D15, and refer to the section of [Trigger Source](#) for more details. The current source is displayed in the trigger label on the top of the screen.

The source can only be triggered stably when the selected channel has a connected signal and to be the trigger source.

(4) Trigger Coupling

Click on the “Trigger Coupling” to select DC, AC, LF reject, HF reject, and refer to refer to the section of [Trigger Coupling](#) for more details.

(5) Edge Type

Select a signal to trigger on which edge. The current edge type is displayed in the trigger label on the top of the screen.

- a. Rising edge: Set a signal to trigger on the rising edge
- b. Falling edge: Set a signal to trigger on the falling edge
- c. Random edge: Set a signal to trigger on the rising and falling edge

(6) Level

Tap to select “Level”, the trigger level can be changed by using the Multipurpose, trigger level

rotary knob and the numeric keyboard on the front panel, and refer to the section of [Trigger level](#) for more details.

8.3. Pulse Width Trigger

Pulse width trigger sets the oscilloscope to trigger on the specified width and a positive or negative pulse meets the judgment conditions. The pulse width trigger menu can set the source, trigger condition, the upper/lower limit, polarity (positive/negative), Trigger type, trigger mode and Trigger level.

(1) Trigger type

Press the **Menu** softkey in the trigger area on the front panel or tap the “T” trigger label on the top to enter the “Trigger” menu. Tap on the “Trigger type” to select “Pulse Width”.

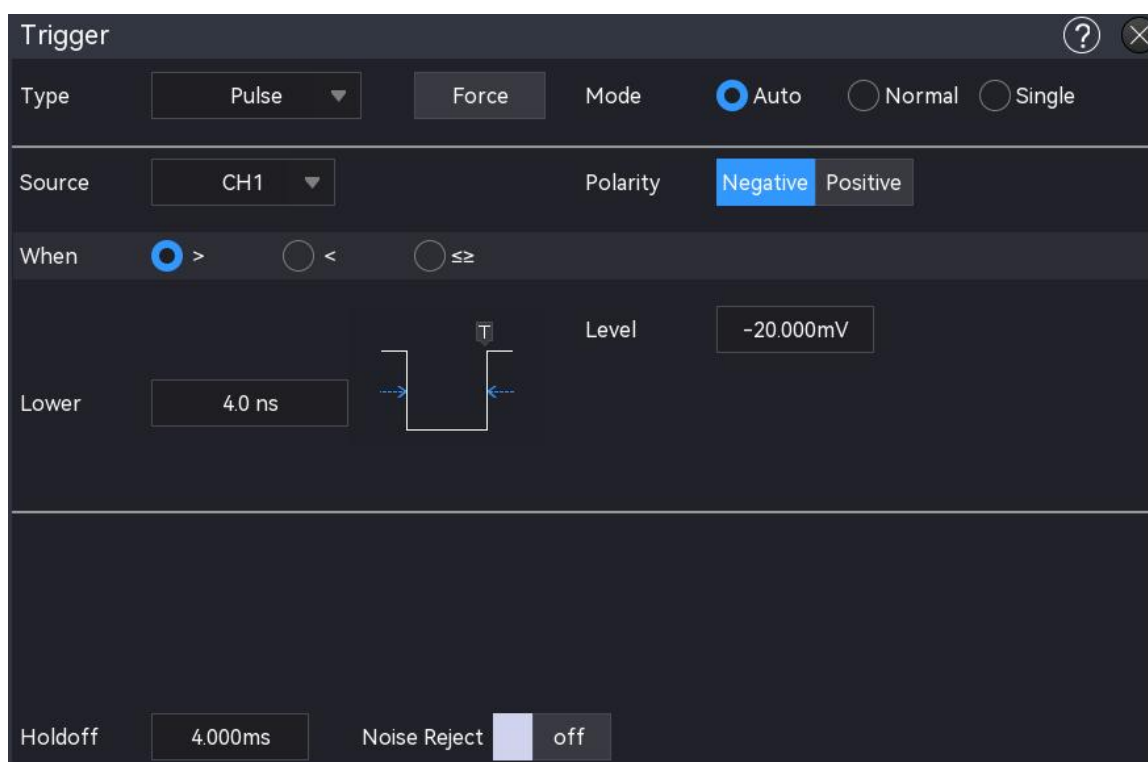

(2) Trigger Mode

Set the trigger mode to auto, normal or single, and refer to the section of [Trigger Mode](#) for more details.

(3) Source

Click on the “Source” to select CH1~CH4, main electricity, EXT or D0~D15, and refer to the section of [Trigger Source](#) for more details. The current source is displayed in the trigger label on the top of the screen.

The source can only be triggered stably when the selected channel has a connected signal and to be the trigger source.

(4) Trigger Condition

- a. $>$: When the pulse width of the trigger signal (positive pulse width, negative pulse width) is greater than the set pulse width, the lower limit can be set.
- b. $<$: When the pulse width of the trigger signal (positive pulse width, negative pulse width) is less than the set pulse width, the upper limit can be set.
- c. $\leq\geq$: When the pulse width of the trigger signal (positive pulse width, negative pulse width) is basically the same as the set pulse width or the pulse width of the trigger signal is triggered within the set range, the upper and lower limit can be set.

(5) Upper/Lower Limit

The set pulse width is compared to the pulse width of the trigger signal. It will be generated when the trigger condition is met. The range can be set to 0.8 ns ~ 4 s.

- When the trigger condition is “ $>$ ” or “ $<$ ”, click on the text field of lower limit or upper limit to pop up the numeric keyboard to set the lower or upper limit; or rotate the Multipurpose rotary knob on the front panel to adjust the lower or upper limit.
- When the trigger condition is “ $\leq\geq$ ”, click on the text field of lower limit or upper limit to pop up the numeric keyboard to set the lower or upper limit; or rotate the Multipurpose rotary knob on the front panel to adjust the lower or upper limit, the lower limit must be less than or equal to the upper limit.

(6) Level

Tap to select “Level”, the trigger level can be changed by using the Multipurpose, trigger level rotary knob and the numeric keyboard on the front panel, and refer to the section of Trigger level for more details.

8.4. Video Trigger

The video signal includes the image and the time sequence information. It has multiple standards and formats. MSO2000X/3000X can be triggered on the field or line of the standard video signal, i.e. NTSC (National Television Standards Committee), PAL (Phase Alternating Line) and SECAM (Sequential Couleur A Memoire).

(1) Trigger type

Press the Menu softkey in the trigger area on the front panel or tap the “T” trigger label on the top to enter the “Trigger” menu. Tap on the “Trigger type” to select “Video”.



(2) Trigger Mode

Set the trigger mode to auto, normal or single, and refer to the section of [Trigger Mode](#) for more details.

(3) Source

Click on the “Source” to select CH1~CH4, and refer to the section of [Trigger Source](#) for more details. The current source is displayed in the trigger label on the top of the screen.

The source can only be triggered stably when the selected channel has a connected signal and to be the trigger source.

(4) Video Format

Click on the “Video Format” to select.

- a. PAL: The frame frequency is 25 frames per second, the TV scan line is 625 lines, the odd field is in the front and the even field is in the rear.
- b. NTSC: The field frequency is 60 fields per second, and the frame frequency is 30 frames per second. The TV scan line is 525 lines. The even field is in the front and the odd field is in the rear.
- c. SECAM: The frame frequency is 25 frames per second, the TV scan line is 625 lines, interlaced scanning.

Video format	Frame frequency (Frame)	Sweep type	TV scan line (Line)
NTSC	30	Interlaced scanning	525
PAL/SECAM	25	Interlaced scanning	625
525p/60	60	Progressive scanning	525
625p/50	50	Progressive scanning	625
720p/24	24	Progressive scanning	750
720p/25	25	Progressive scanning	750
720p/30	30	Progressive scanning	750
720p/50Hz	50	Progressive scanning	750
720p/60Hz	60	Progressive scanning	750
1080p/24Hz	24	Progressive scanning	1125
1080p/25Hz	25	Progressive scanning	1125
1080p/30Hz	30	Progressive scanning	1125
1080i/25Hz	25	Progressive scanning	1125
1080i/30Hz	30	Progressive scanning	1125
1080Psf/24	24	Progressive scanning	1125

(5) Synchronization

- a. Even field: Set to trigger on the rising edge of the first sawtooth pulse on the even field. This is only available when the video format is NTSC and PAL/SECAM.
- b. Odd field: Set to trigger on the rising edge of the first sawtooth pulse on the odd field. This is only available when the video format is NTSC and PAL/SECAM.

- c. All lines: Set to trigger and synchronize on the first line of the video signal.
- d. Specified lines: Set to trigger and synchronize on the specified lines. The specified line number can be set by using the Multipurpose rotary knob. The line number range is related to the video format, and the range is 1 ~ 525 (NTSC), 1 ~ 625 (PAL/SECAM), 1 ~ 525 (525p), 1 ~ 625 (625p), 1 ~ 750 (720p), 1 ~ 1125 (1080p/1080i).

(6) Level

Tap to select “Level”, the trigger level can be changed by using the Multipurpose, trigger level rotary knob and the numeric keyboard on the front panel, and refer to the section of [Trigger level](#) for more details.

Tips: In order to observe the waveform details in the video signal, the user can set the memory depth a little bigger.

MSO2000X/3000X series adopts the UNI-T original digital 3D technology with a multi-level greyscale display function, so that different brightness can reflect the frequency of different parts of the signal. It can help experienced users to quickly judge the signal quality during the debugging process and find the unusual conditions.

8.5. Slope Trigger

Slope trigger refers to triggering on the rising edge or falling edge in the specified time, it is suitable for observing the sawtooth wave and triangular wave. The slope trigger menu can set the source, trigger mode, edge type (rising/falling edge), slope condition, upper/lower limit of time and high/low level.

(1) Trigger type

Press the Menu softkey on the front panel or tap the “T” trigger label on the top to enter the “Trigger” menu. Tap on the “Trigger type” to select “Slope”.

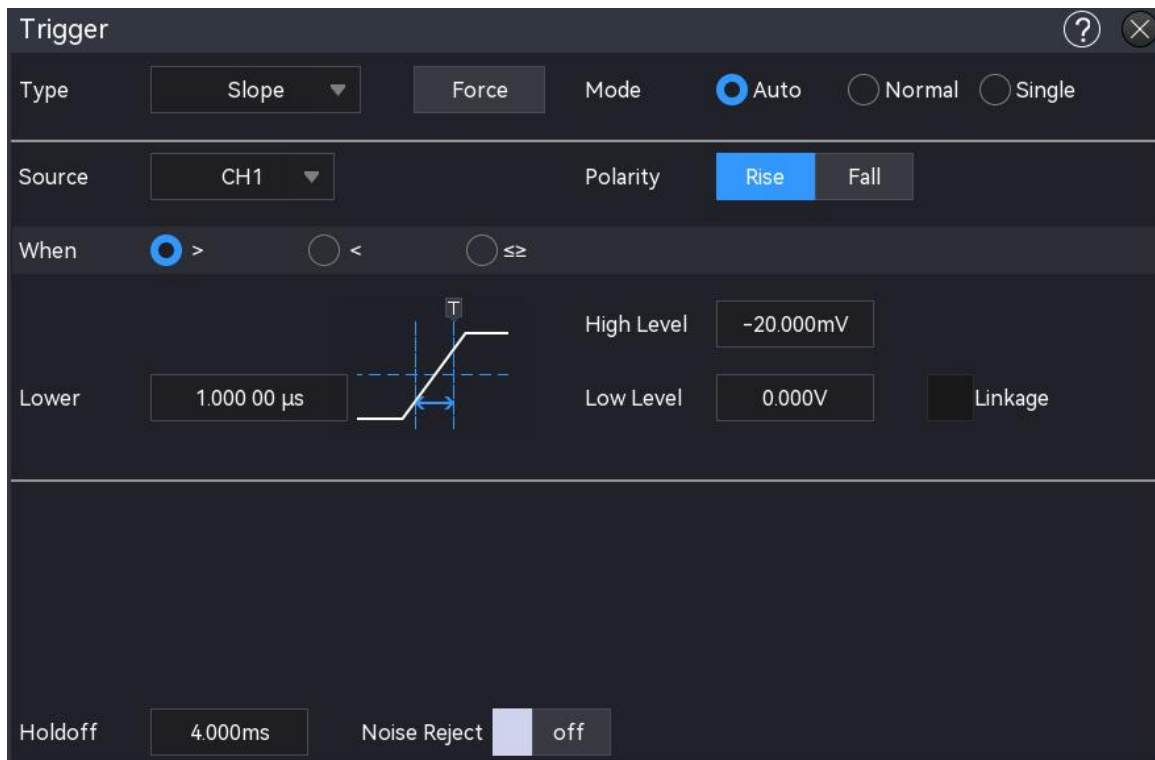

(2) Trigger Mode

Set the trigger mode to auto, normal or single, and refer to the section of [Trigger Mode](#) for more details.

(3) Source

Click on the “Source” to select CH1~CH4, and refer to the section of [Trigger Source](#) for more details. The current source is displayed in the trigger label on the top of the screen.

The source can only be triggered stably when the selected channel has a connected signal and to be the trigger source.

(4) Edge Type

Select the slope trigger edge.

- a. Rising edge: Use the rising edge of a trigger signal to perform the slope trigger
- b. Falling edge: Use the falling edge of a trigger signal to perform the slope trigger

(5) Time Condition

- a. > : When the slope time of the trigger signal (positive pulse width, negative pulse width) is greater than the set slope time, the lower limit of time can be set.
- b. < : When the slope time of the trigger signal (positive pulse width, negative pulse width) is less than the set slope time, the upper limit of time can be set.
- c. $\leq \geq$: When the slope time of the trigger signal (positive pulse width, negative pulse width) is basically the same as the set slope time or triggered within the set slope time, the lower and upper limit of time can be set.

Note: The slope time of the trigger signal: “slope time of rising edge”, “slope time of falling edge” as shown in the following figure.

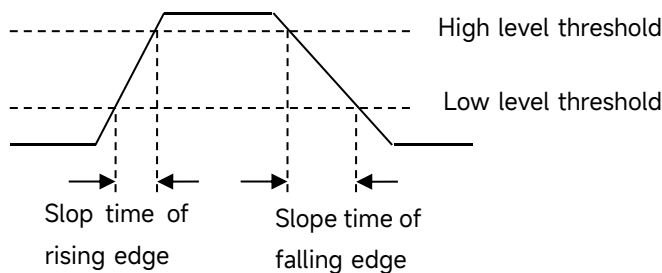

(6) High/Low Level

The slope trigger requires the high level and low level to be set. The slope trigger can only be stable generated when all conditions are met.

Tap to select “High Level” or “Low Level”, the high level and low level can be changed by using the Multipurpose and the numeric keyboard on the front panel, and refer to the section of [Trigger level](#) for more details.

Correlation: Tick the correlation, i.e. if one level changes, the other will also change.

(7) Lower/Upper Limit of Time

- When the trigger condition is “>” or “<”, click on the text field of lower limit or upper limit to pop up the numeric keyboard to set the lower or upper limit of time; or rotate the Multipurpose rotary knob on the front panel to adjust the lower or upper limit of time.
- When the trigger condition is “≤≥”, click on the text field of lower limit or upper limit to pop up the numeric keyboard to set the lower or upper limit of time; or rotate the Multipurpose rotary knob on the front panel to adjust the lower or upper limit of time, the lower limit of time must be less than or equal to the upper limit of time.

The time range can be set to 3.2 ns ~ 1 s.

Note: The set slew rate is displayed on the bottom left of the screen.

The calculation formula of slew rate: **(High level threshold - low level threshold) ÷ Time**

For the set slew rate, the time here is the set slope time.

8.6. Runt Trigger

The runt trigger is used to trigger a pulse that has crossed one trigger level but not the other.

In this oscilloscope, the positive runt pulse is the pulse that crosses the lower limit of the trigger level but does not cross the upper limit of the trigger level; the negative runt pulse is the pulse that crosses the upper limit of the trigger level but does not cross the lower limit of the trigger level, as shown in the following figure.

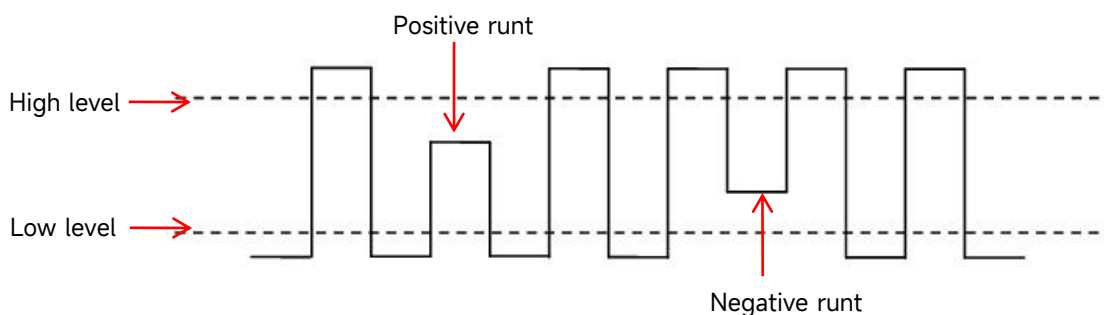

The runt trigger menu can set the source, trigger mode, polarity (positive, negative), runt condition (irrelevance, <, >, ≤, ≥), the lower/upper limit of time and high/low level.

(1) Trigger type

Press the **Menu** softkey on the front panel or tap the “T” trigger label on the top to enter the “Trigger” menu. Tap on the “Trigger type” to select “Runt”.

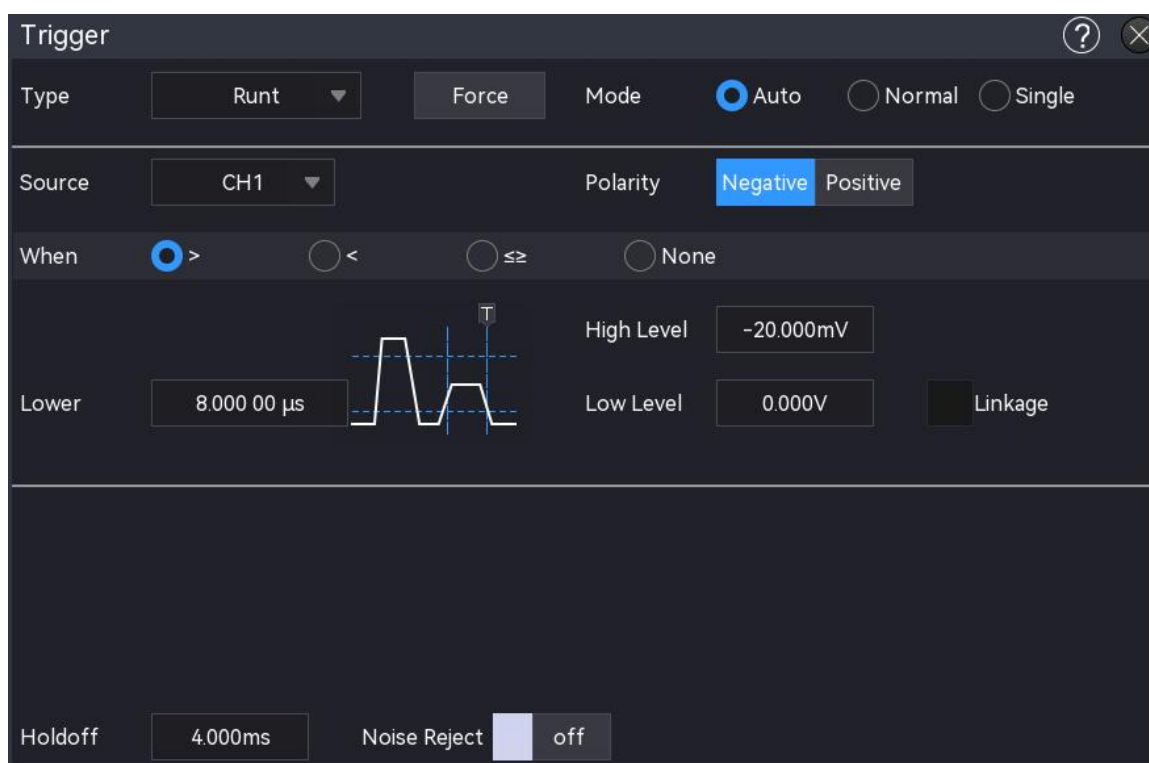

(2) Trigger Mode

Set the trigger mode to auto, normal or single, and refer to the section of [Trigger Mode](#) for more details.

(3) Source

Click on the “Source” to select CH1~CH4, and refer to the section of [Trigger Source](#) for more details. The current source is displayed in the trigger label on the top of the screen.

The source can only be triggered stably when the selected channel has a connected signal and to be the trigger source.

(4) Polarity

a. Positive: Set to trigger on the positive runt pulse

b. Negative: Set to trigger on the negative runt pulse

(5) Runt condition

- a. $>$: When the runt pulse width is greater than the lower limit of the set pulse width, the lower limit of time can be set.
- b. $<$: When the runt pulse width is less than the upper limit of the set pulse width, the upper limit of time can be set.
- c. \leq : When the runt pulse width is equal to the lower or upper limit of time, the upper and lower limit of time can be set at the same time.
- d. Irrelevance: The runt pulse width is not compared to the time.

(6) High/Low Level

The runt trigger requires the high level and low level to be set. The runt trigger can only be stable generated when all conditions are met.

Tap to select "High Level" or "Low Level", the high level and low level can be changed by using the Multipurpose and the numeric keyboard on the front panel, and refer to the section of [Trigger level](#) for more details.

Correlation: Tick the correlation, i.e. if one level changes, the other will also change.

(7) Lower/Upper Limit of Time

- When the trigger condition is " $>$ " or " $<$ ", click on the text field of lower limit or upper limit to pop up the numeric keyboard to set the lower or upper limit of time; or rotate the Multipurpose rotary knob on the front panel to adjust the lower or upper limit of time.
- When the trigger condition is " \leq ", click on the text field of lower limit or upper limit to pop up the numeric keyboard to set the lower or upper limit of time; or rotate the Multipurpose rotary knob on the front panel to adjust the lower or upper limit of time, the lower limit of time must be less than or equal to the upper limit of time.

The time range can be set to 3.2 ns ~ 10 s.

8.7. Window Trigger

The window trigger level has a high level and a low level, when the rising edge of the input signal crosses the high level or the falling edge crosses the low level, the oscilloscope will be triggered, as shown in the following figure.

The over-amplitude pulse trigger menu can set the source, trigger mode, over-amplitude type (rising edge, falling edge, random edge), trigger position (enter, exit, time), over-amplitude time, and high/low level.

(1) Trigger type

Press the **Menu** softkey on the front panel or tap the “T” trigger label on the top to enter the “Trigger” menu. Tap on the “Trigger type” to select “Window”.

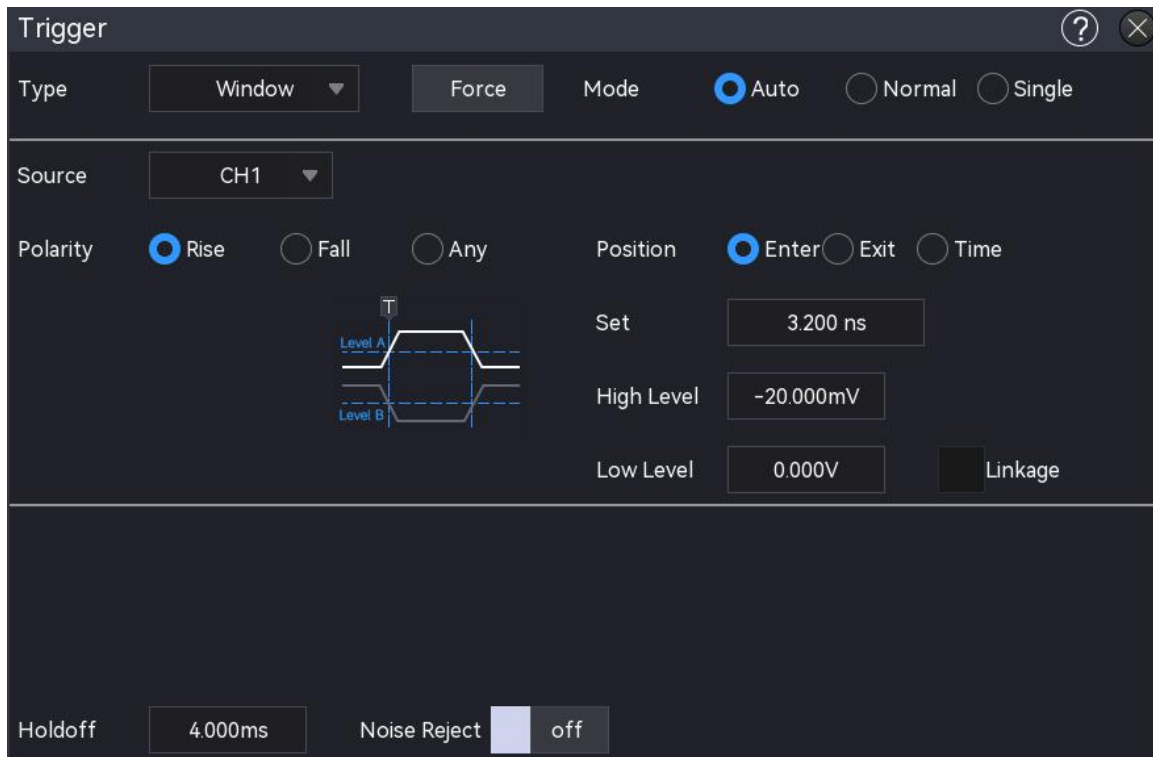

(2) Trigger Mode

Set the trigger mode to auto, normal or single, and refer to the section of [Trigger Mode](#) for more details.

(3) Source

- Click on the “Source” to select CH1~CH4, and refer to the section of [Trigger Source](#) for more details. The current source is displayed in the trigger label on the top of the screen.
- The source can only be triggered stably when the selected channel has a connected signal and to be the trigger source.

(4) Over-amplitude Type

Set the input signal to trigger on which edge. The edge can be set to rising, falling and random. The current over-amplitude type is displayed on the top right corner of the screen.

- a. Rising edge: Set to trigger on the rising edge of the input signal and when the voltage level is greater than the set high level.
- b. Falling edge: Set to trigger on the falling edge of the input signal and when the voltage level is less than the set low level.
- c. Random edge: Set to trigger on the random edge of the input signal and when the voltage level meets the set high or low level.

(5) Trigger Position

The trigger position can be set to enter, exit or time. It is helpful to further confirm the trigger time.

- a. Enter: It will be generated when the input signal enter the specified trigger level.
- b. Exit: It will be generated when the input signal exit the specified trigger level.
- c. Time: It will be generated when entered over-amplitude accumulated hold time is greater than or equal to the preset over-amplitude time.

(6) Over-amplitude Time

If the trigger position is “Time” and the over-amplitude time is available, it will be triggered when the condition is met. Click on the “Over-amplitude” text field to pop up the numeric keyboard to set the over-amplitude time; or rotate the Multipurpose rotary knob on the front panel to set the over-amplitude time.

The over-amplitude time can be set to 3.2 ns ~ 10 s.

(7) High/Low Level

The over-amplitude trigger requires the high level and low level to be set. The over-amplitude trigger can only be stable generated when all conditions are met.

Tap to select “High Level” or “Low Level”, the high level and low level can be changed by using the Multipurpose and the numeric keyboard on the front panel, and refer to the section of [Trigger level](#) for more details.

Correlation: Tick the correlation, i.e. if one level changes, the other will also change.

8.8. Delay Trigger

Delay trigger requires the trigger source 1 and trigger source 2 to be set. When the time difference (ΔT) between the edge set by source 1 (edge 1) and the edge set by source 2 (edge 2) meets the preset time limit, the oscilloscope will be triggered, as shown in the following figure.

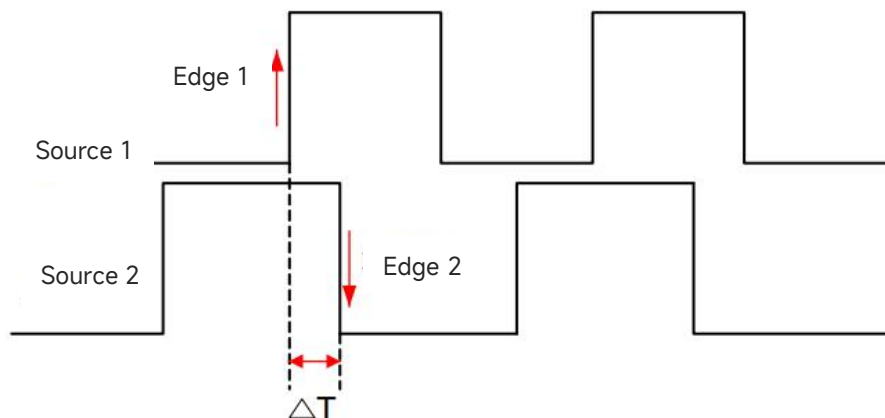

Edge 1 is set as the rising edge. Edge 2 is set as the falling edge. ΔT is the area marked in red.

Note: Edge 1 and edge 2 must be adjacent edges

Note: Only the channel that has a connected signal and to be the trigger source can be triggered stably.

(1) Trigger type

Press the **Menu** softkey on the front panel or tap the “T” trigger label on the top to enter the “Trigger” menu. Tap on the “Trigger type” to select “Delay”.

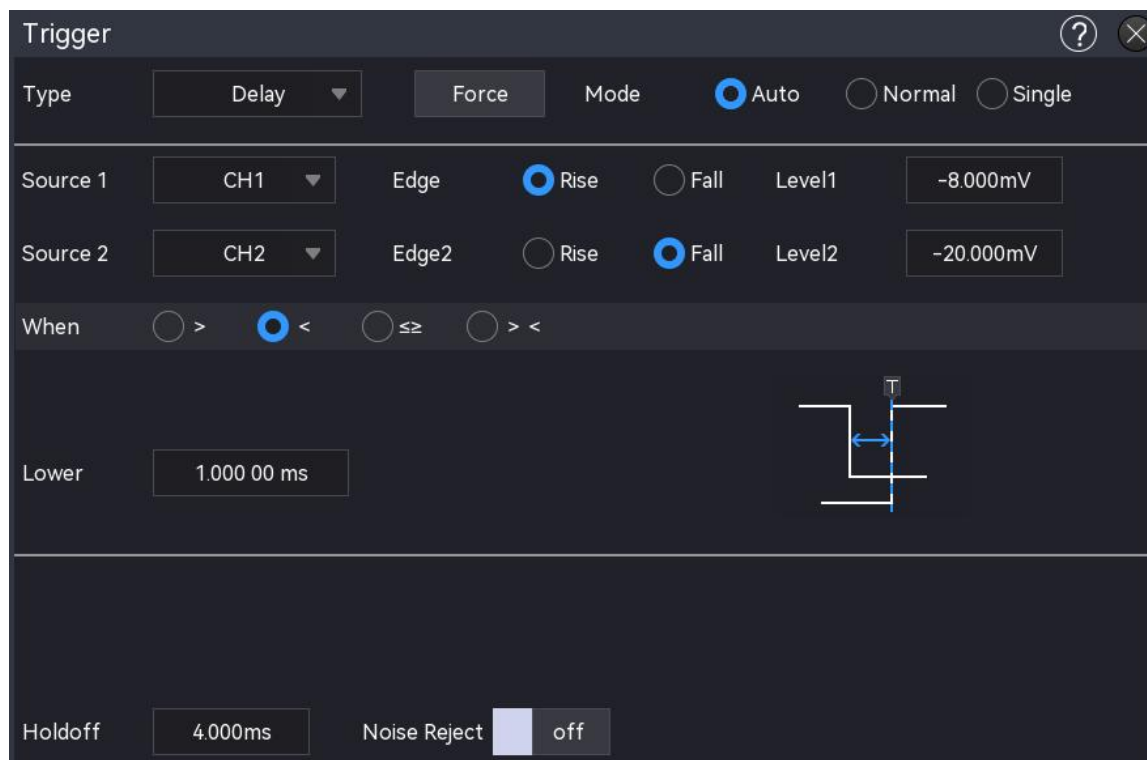

(2) Trigger Mode

Set the trigger mode to auto, normal or single, and refer to the section of [Trigger Mode](#) for more details.

(3) Source 1

Click on the “Source 1” to select CH1~CH4, D0~D15, and refer to the section of [Trigger Source](#) for more details. The current source is displayed in the trigger label on the top of the screen. The source can only be triggered stably when the selected channel has a connected signal and to be the trigger source.

(4) Edge 1

Click on the “Edge 1” to set the trigger edge for “Source 1”, it can be set rising or falling edge.

(5) Source 2

Click on the “Source 2” to select CH1~CH4, D0~D15, and refer to the section of [Trigger Source](#) for more details. The current source is displayed in the trigger label on the top of the screen. The source can only be triggered stably when the selected channel has a connected signal and to be the trigger source.

(6) Edge 2

Click on the "Edge 2" to set the trigger edge for "Source 2", it can be set rising or falling edge.

(7) Delay Condition

- a. $>$: It will be generated when the time difference (ΔT) between the edge of source 1 and the edge of source 2 is greater than the set lower limit of time, and the lower limit of time can be set.
- b. $<$: It will be generated when the time difference (ΔT) between the edge of source 1 and the edge of source 2 is greater than the set upper limit of time, and the upper limit of time can be set.
- c. \leq : It will be generated when the time difference (ΔT) between the edge of source 1 and the edge of source 2 is greater than or equal to the set lower limit of time and less than or equal to the set upper limit of time, and the upper/lower limit of time can be set.
- d. $> <$: It will be generated when the time difference (ΔT) between the edge of source 1 and the edge of source 2 is less than the set lower limit of time or greater than the set upper limit of time, and the upper/lower limit of time can be set.

(8) Lower/Upper Limit of Time

- When the trigger condition is " $>$ " or " $<$ ", click on the text field of lower limit or upper limit to pop up the numeric keyboard to set the lower or upper limit of time; or rotate the Multipurpose rotary knob on the front panel to adjust the lower or upper limit of time.
- When the trigger condition is " \leq ", click on the text field of lower limit or upper limit to pop up the numeric keyboard to set the lower or upper limit of time; or rotate the Multipurpose rotary knob on the front panel to adjust the lower or upper limit of time, the lower limit of time must be less than or equal to the upper limit of time.

The time range can be set to 3.2 ns ~ 10 s.

(9) Level 1, level 2

Delay trigger requires the trigger source 1 and trigger source 2 to be set. It can only stable generated when all conditions are met. The level can be changed by using the Multipurpose and the numeric keyboard on the front panel, and refer to the section of [Trigger level](#) for more details.

8.9. Timeout Trigger

The oscilloscope will be triggered when the time interval (ΔT) from the rising edge (or falling edge) of the input signal across the trigger level and to the adjacent falling edge (rising edge) across the trigger level is greater than the set timeout time, as shown in the following figure.

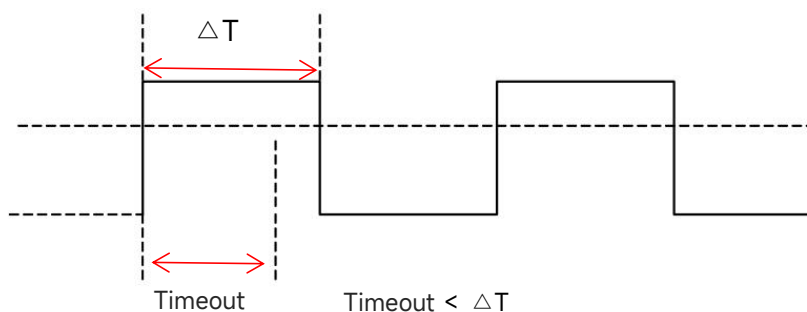

(1) Trigger type

Press the **Menu** softkey on the front panel or tap the “T” trigger label on the top to enter the “Trigger” menu. Tap on the “Trigger type” to select “Timeout”.

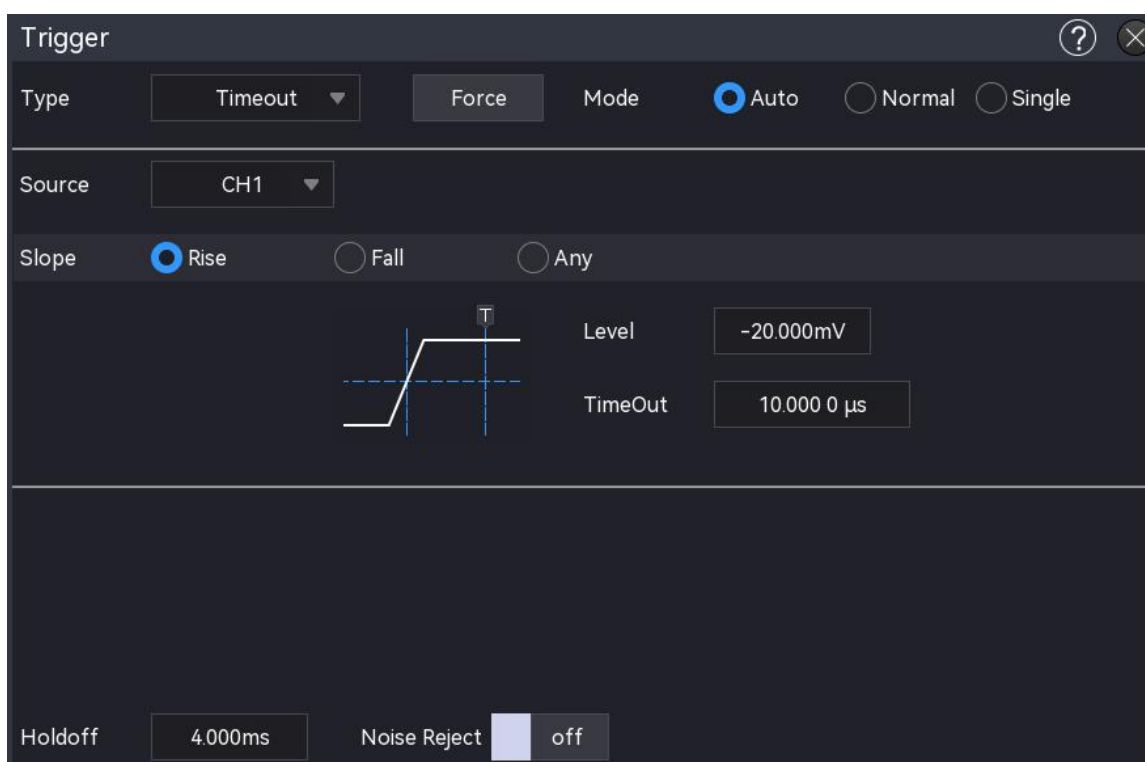

(2) Trigger Mode

Set the trigger mode to auto, normal or single, and refer to the section of [Trigger Mode](#) for more details.

(3) Source

Click on the “Source” to select CH1~CH4 or D0~D15, and refer to the section of [Trigger Source](#) for more details. The current source is displayed in the trigger label on the top of the screen. The source can only be triggered stably when the selected channel has a connected signal and to be the trigger source.

(4) Edge Type

Select an input signal to trigger on when it across which edge. The current edge type is

displayed in the top right corner.

- a. Rising edge: Set to count the time when the rising edge of the input signal across the trigger level
- b. Falling edge: Set to count the time when the falling edge of the input signal across the trigger level
- c. Random edge: Set to count the time when the rising or falling edge of the input signal across the trigger level

(5) Timeout

Timeout is used to set the maximum hold time after the input signal across the trigger level. It will be generated when $\text{timeout} < \Delta T$. Click on the "Timeout" text field to pop up the numeric keyboard to set the timeout; or rotate the Multipurpose rotary knob on the front panel to adjust the timeout.

The timeout range can be set to 3.2ns ~ 10 s.

(6) Level

Tap to select "Level", the trigger level can be changed by using the Multipurpose, trigger level rotary knob and the numeric keyboard on the front panel, and refer to the section of [Trigger level](#) for more details.

8.10. Duration Trigger

When the duration trigger is selected, the oscilloscope identifies the trigger condition by looking for the duration of the specified codes. The code pattern is the combination of channel logic "AND", and the value of each channel can be H (high), L (low), or X (ignore). It will be generated when the duration (ΔT) of the code pattern meets a preset time, as shown in the following figure.

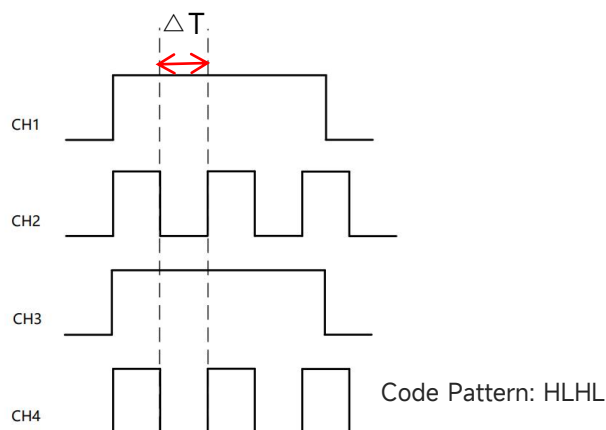

(1) Trigger type

Press the **Menu** softkey on the front panel or tap the “T” trigger label on the top to enter the “Trigger” menu. Tap on the “Trigger type” to select “Duration”.

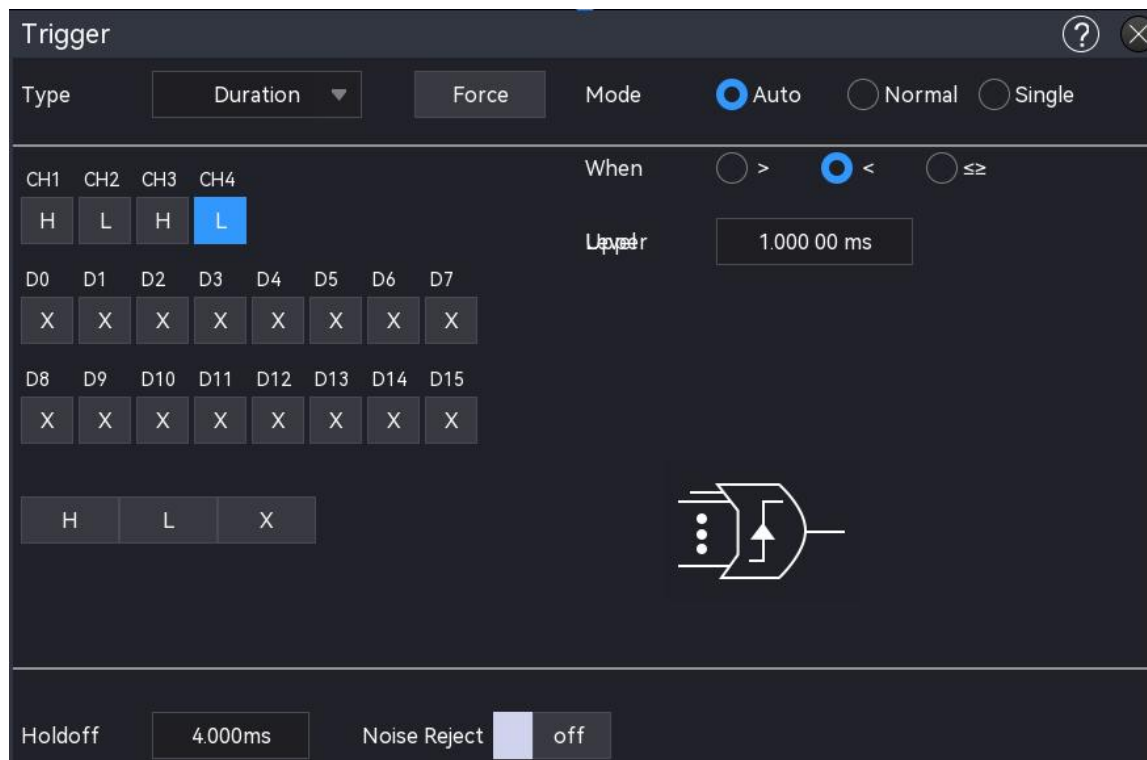

(2) Trigger Mode

Set the trigger mode to auto, normal or single, and refer to the section of [Trigger Mode](#) for more details.

(3) Source

Click on the “Source” to select CH1~CH4 or D0~D15, and refer to the section of [Trigger Source](#) for more details. The current source is displayed in the trigger label on the top of the screen. The source can only be triggered stably when the selected channel has a connected signal and to be the trigger source.

(4) Code Pattern

The code pattern can be set to H, L, X, the code pattern of each channel is displayed at the bottom of the screen, as shown in the figure above.

- H: Set the code pattern for the selected channel to “High”, i.e. the voltage level is higher than the trigger level of the channel.
- L: Set the code pattern for the selected channel to “Low”, i.e. the voltage level is lower than the trigger level of the channel.
- X: Set the code pattern for the selected channel to “X”, i.e. the channel is not part of the code pattern, the oscilloscope will not be triggered if all channel in the code pattern are set

to "X".

(5) Trigger Condition

- a. $>$: It will be generated when the duration is greater than the set lower limit of time, and the lower limit of time can be set.
- b. $<$: It will be generated when the duration is less than the set upper limit of time, and the upper limit of time can be set.
- c. $\leq\geq$: It will be generated when the duration is less than or equal to the set upper limit of time and greater than or equal to the lower limit of time, and the upper/lower limit of time can be set.

(6) Lower/Upper Limit of Time

- When the trigger condition is " $>$ " or " $<$ ", click on the text field of lower limit or upper limit to pop up the numeric keyboard to set the lower or upper limit of time; or rotate the Multipurpose rotary knob on the front panel to adjust the lower or upper limit of time.
- When the trigger condition is " $\leq\geq$ ", click on the text field of lower limit or upper limit to pop up the numeric keyboard to set the lower or upper limit of time; or rotate the Multipurpose rotary knob on the front panel to adjust the lower or upper limit of time, the lower limit of time must be less than or equal to the upper limit of time.
- The time range can be set to 3.2 ns ~ 10 s.

(7) Level

Tap to select "Level", the trigger level can be changed by using the Multipurpose, trigger level rotary knob and the numeric keyboard on the front panel, and refer to the section of [Trigger level](#) for more details.

8.11. Setup & Hold Trigger

The setup/hold trigger require the data signal line and clock signal line to be set. The setup time begins when the data signal crosses the trigger level and ends when the specified clock edge arrives. The hold time begins when the specified clock edge arrives and ends when the data signal crosses the trigger level again (as shown in the following figure). The oscilloscope will be triggered when the setup time or the hold time is less than the pre-set time. It is mainly used to locate and find the error code, and quickly find the signal that cannot meet setup and hold time.

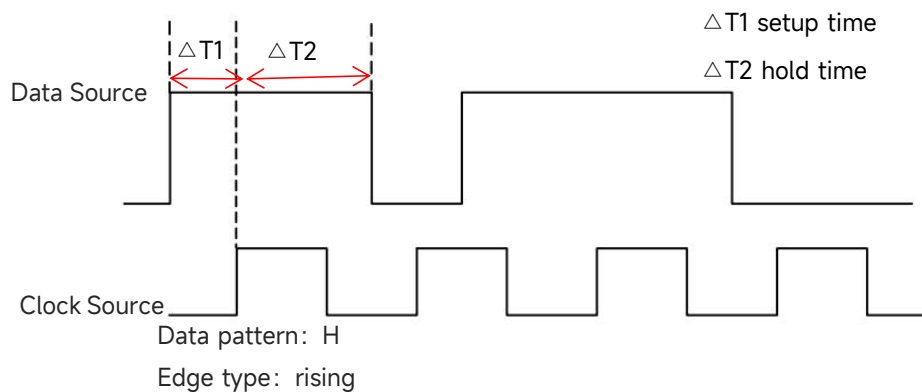

(1) Trigger type

Press the **Menu** softkey on the front panel or tap the “T” trigger label on the top to enter the “Trigger” menu. Tap on the “Trigger type” to select “Setup & Hold”.

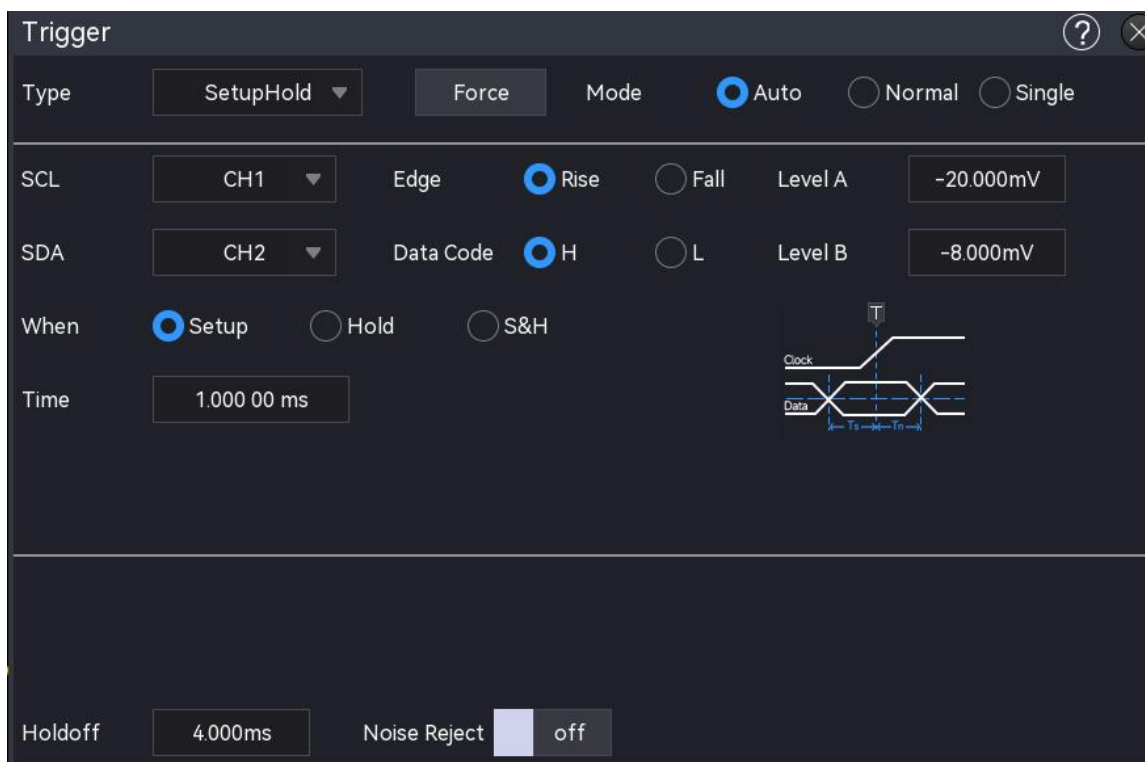

(2) Trigger Mode

Set the trigger mode to auto, normal or single, and refer to the section of [Trigger Mode](#) for more details.

(3) Data Source

Click on the “Data Source” to select CH1-CH4, D0-D15, and refer to the section of [Trigger Source](#) for more details. The current source is displayed in the trigger label on the top of the screen

The source can only be triggered stably when the selected channel has a connected signal and to be the trigger source.

(4) Data Type

Select the valid code pattern for the data signal, it can be set to H, L.

- a. H: Set the valid code pattern for the data signal to high level
- b. L: Set the valid code pattern for the data signal to low level

(5) Clock Source

Click on the "Clock Source" to select CH1~CH4, and refer to the section of [Trigger Source](#) for more details. The current source is displayed in the trigger label on the top of the screen.

The source can only be triggered stably when the selected channel has a connected signal and to be the trigger source.

(6) Edge Type

- a. Rising edge: Set the clock edge to rising edge
- b. Falling edge: Set the clock edge to falling edge

(7) Trigger Condition

- a. Setup: It will be generated when the setup time is less than the set time.
- b. Hold: It will be generated when the hold time is less than the set time.
- c. Setup & Hold: It will be generated when the setup and hold time is less than the set time.

(8) Time

The setup and hold time ΔT is compared to the set time, it will be generated when the condition is met. Click on the "Timeout" text field to pop up the numeric keyboard to set the timeout; or rotate the [Multipurpose](#) and the numeric keyboard on the front panel to adjust the timeout.

The timeout range can be set to 3.2 ns ~ 10 s.

(9) Data Level, Clock Level

The setup & hold trigger requires the data level, clock level to be set. The setup & hold trigger can only be stable generated when all conditions are met.

Tap to select "Data Level" or "Clock Level", the data level and clock level can be changed by using the [Multipurpose](#) and the numeric keyboard on the front panel, and refer to the section of [Trigger level](#) for more details.

8.12. Nth Edge Trigger

The Nth edge trigger refers to be triggered on the Nth edge after the specified idle time. For example, waveform as shown in the following figure, it is set to trigger on the 2nd rising edge after

the specified idle time (the time between two adjacent rising edges), then set the idle time as $P < \text{idle time} < M$, M is the time between the 1st rising edge and the next rising edge, P is the maximum time between the counting rising edge, as shown in the following figure.

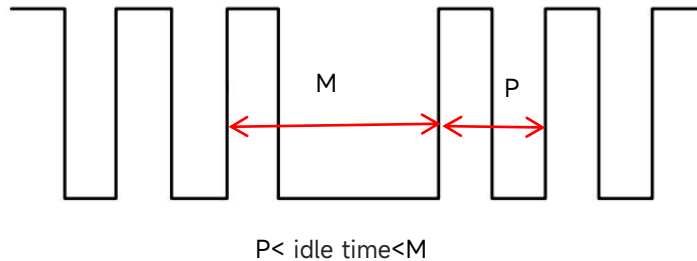

(1) Trigger type

Press the **Menu** softkey on the front panel or tap the “T” trigger label on the top to enter the “Trigger” menu. Tap on the “Trigger type” to select “Nth Edge”.

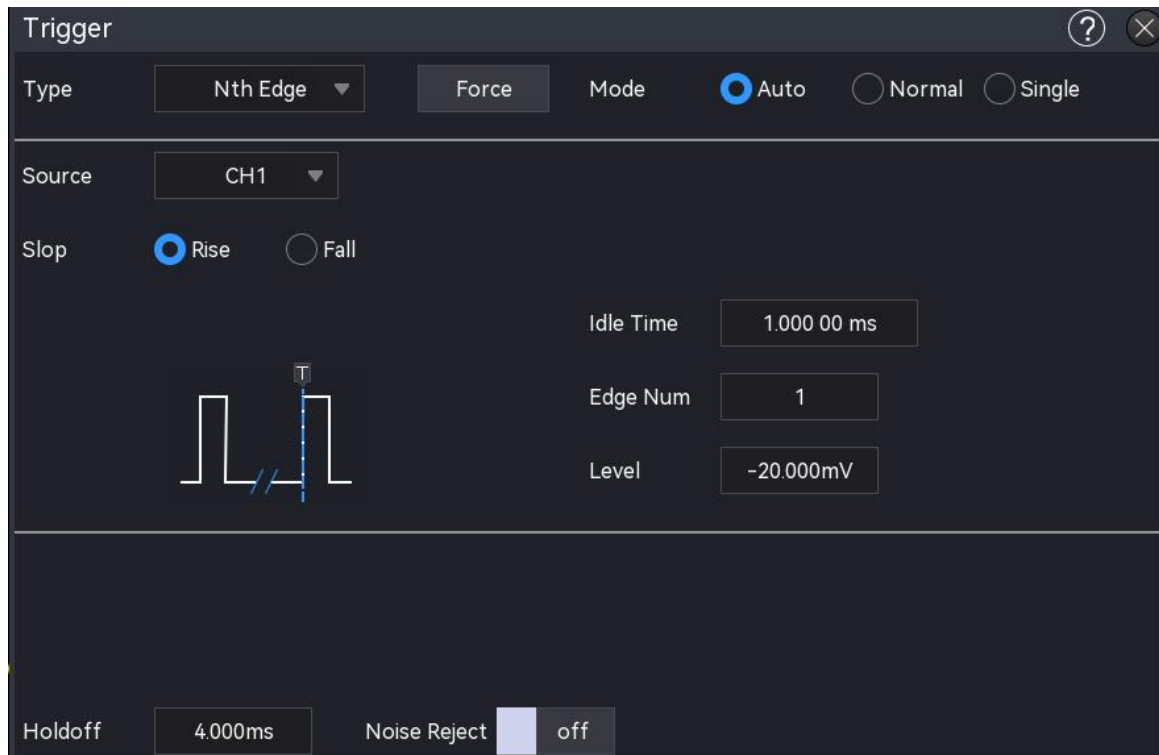

(2) Trigger Mode

Set the trigger mode to auto, normal or single, and refer to the section of [Trigger Mode](#) for more details.

(3) Source

Click on the “Source” to select CH1~CH4 or D0~D15, and refer to the section of [Trigger Source](#) for more details. The current source is displayed in the trigger label on the top of the screen.

The source can only be triggered stably when the selected channel has a connected signal and

to be the trigger source.

(4) Edge Type

Select an input signal to trigger on which edge. The current edge type is displayed in the top right corner.

- a. Rising edge: Set a signal to trigger on the rising edge
- b. Falling edge: Set a signal to trigger on the falling edge

(5) Idle Time

The idle time is compared to the pulse time, it will be generated when the condition is met. Click the "Idle Time" text field to pop up the numeric keyboard to set the idle time; or rotate the Multipurpose rotary knob on the front panel to adjust the idle time.

The idle time range can be set to 3.2 ns ~ 10 s.

(6) Edge Number

The edge number represents Nth edge value. Click on the "Edge Number" text field to pop up the numeric keyboard to set the edge number; or rotate the Multipurpose rotary knob on the front panel to adjust the edge number. The edge number range can be set to 1 ~ 65535.

(7) Level

Tap to select "Level", the trigger level can be changed by using the Multipurpose, trigger level rotary knob and the numeric keyboard on the front panel, and refer to the section of [Trigger level](#) for more details.

8.13. Code Pattern Trigger

The code pattern trigger identifies the trigger condition by looking for the specified patterns. The pattern Trigger type is the combination of the channel logic "AND", each channel can be set to H (high), L (low), X (ignored). You can also specify a channel in the type as a rising edge or falling edge (only one edge can be specified). When the edge is assigned, if the pattern of the other channels are judged "true" (i.e., the actual pattern is consistent with the preset pattern type), the oscilloscope will trigger on the specified edge. If the edge is not assigned, the oscilloscope will trigger at the last edge of the code type "true". If the pattern of all channels are set to "ignore", the oscilloscope will not be triggered.

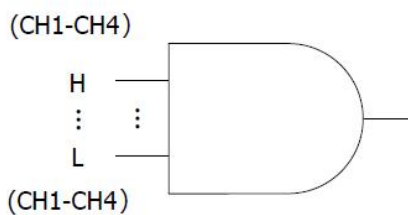

(1) Trigger type

Press the **Menu** softkey on the front panel or tap the “T” trigger label on the top to enter the “Trigger” menu. Tap on the “Trigger type” to select “Code Pattern”.

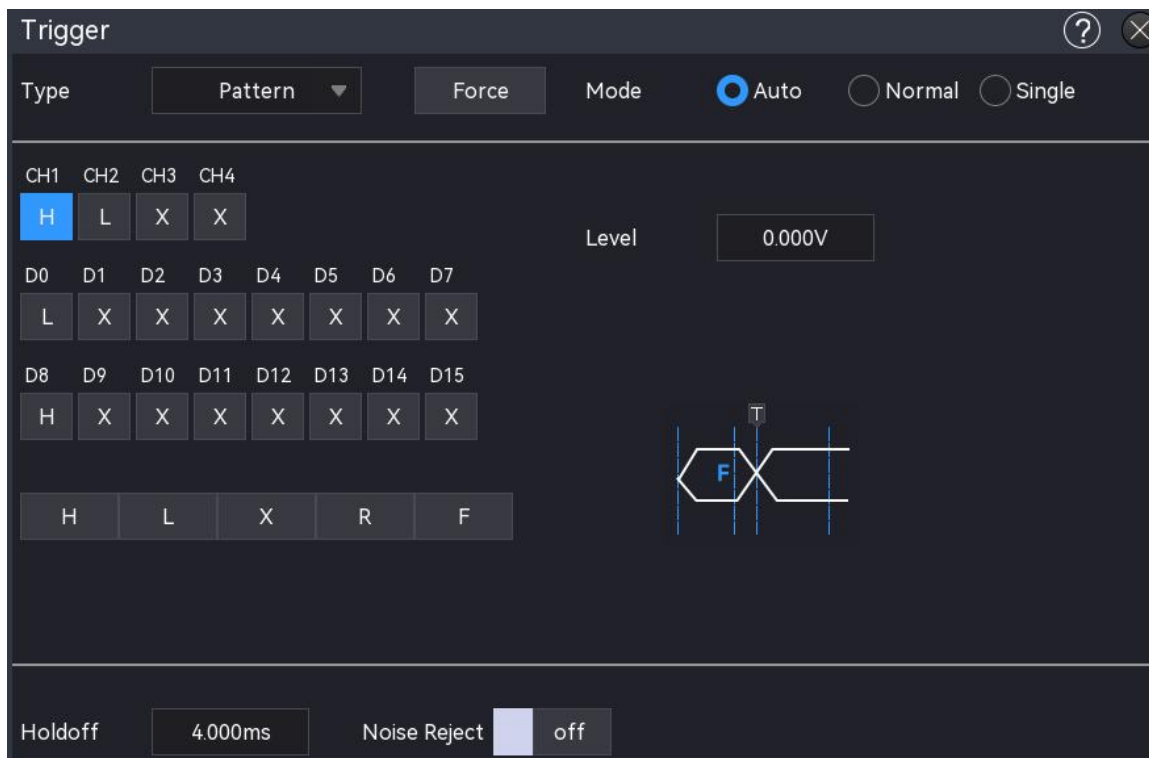

(2) Trigger Mode

Set the trigger mode to auto, normal or single, and refer to the section of [Trigger Mode](#) for more details.

(3) Source

Click on the “Source” to select CH1~CH4 or D0~D15, and refer to the section of [Trigger Source](#) for more details. The current source is displayed in the trigger label on the top of the screen. The source can only be triggered stably when the selected channel has a connected signal and to be the trigger source.

(4) Code Pattern

The code pattern can be set to H, L, X, rising edge or falling edge. The current code pattern is displayed in the top right corner.

- a. H: Set the code pattern for the selected channel to “H”, i.e. the voltage level is higher than

the trigger level of the channel.

- b. L: Set the code pattern for the selected channel to “Low”, i.e. the voltage level is lower than the trigger level of the channel.
- c. X: Set the code pattern for the selected channel to “X”, i.e. the channel is not part of the code pattern, the oscilloscope will not be triggered if all channel in the code pattern are set to “X”.
- d. Rising edge: Set the code pattern for the selected channel to the rising edge.
- e. Falling edge: Set the code pattern for the selected channel to the falling edge.

(5) Level

Tap to select “Level”, the trigger level can be changed by using the [Multipurpose](#), trigger level rotary knob and the numeric keyboard on the front panel, and refer to the section of [Trigger level](#) for more details.

8.14. RS232 Trigger

RS232 bus is a serial communication method for transferring data between computers or between a computer and a terminal.

(1) Trigger type

Press the [Menu](#) softkey on the front panel or tap the “T” trigger label on the top to enter the “Trigger” menu. Tap on the “Trigger type” to select “RS232”.

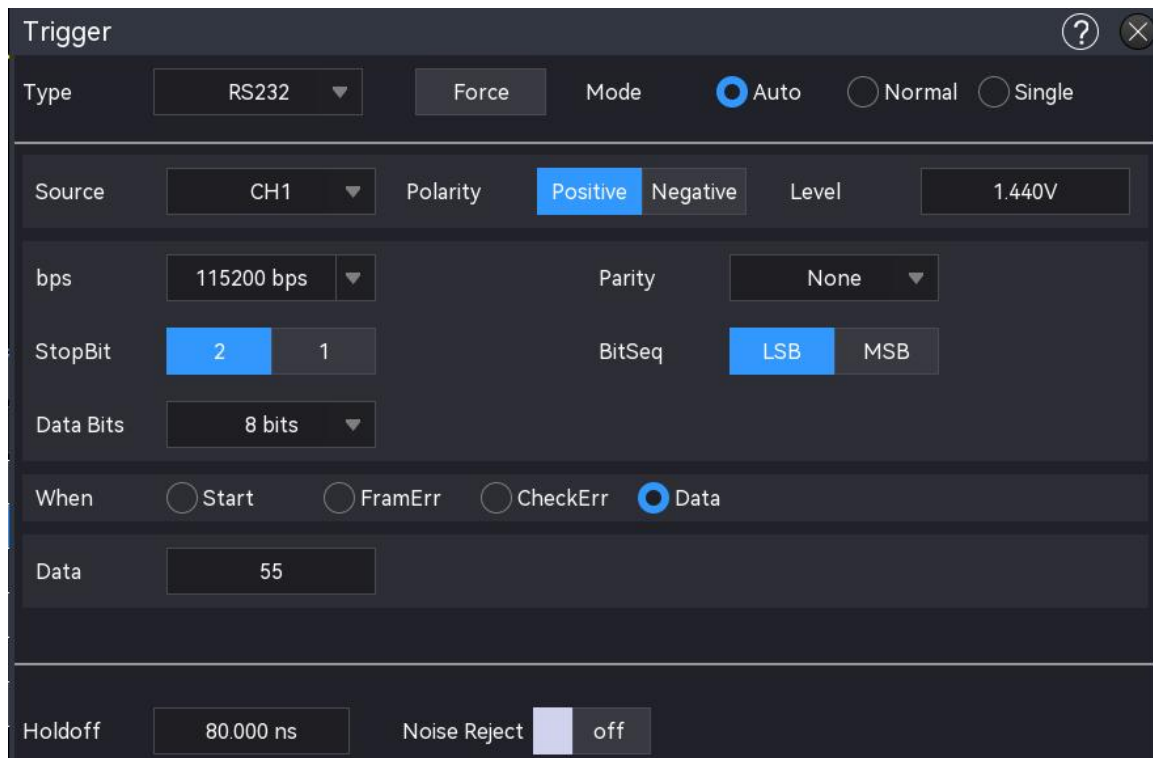

(2) Source

Click on the “Source” to select CH1~CH4 or D0~D15, and refer to the section of [Trigger Source](#) for more details. The current source is displayed in the trigger label on the top of the screen. The source can only be triggered stably when the selected channel has a connected signal and to be the trigger source.

(3) Level

Double-click on the “Level” text field to pop up the numeric keyboard to set the trigger level; rotate the [Multipurpose](#) rotary knob or rotate the trigger [Position](#) rotary knob to adjust the trigger level.

When the trigger level is changed, a dotted line appears on the screen indicating the current trigger level. Once the change is stopped, the dotted line of the trigger level disappears after about 2 seconds.

(4) Polarity

- a. Negative: The reversed polarity of logic level, i.e. the high level is 0 and the low level is 1.
- b. Positive: The normal polarity of logic level, i.e. the high level is 1 and the low level is 0.

(5) Parity check

Set the Parity check of data transmission. Click on the “Parity check” to select to none, even Parity check or odd Parity check.

(6) Data Bit Width

Set the data bit width for RS232 signal, click on the “Data Bit” to select to 5 bits, 6 bits, 7 bits or 8 bits.

(7) Bit Sequence

Set the data bit sequence for RS232 signal, click on the “Bit Sequence” to select to MSB or LSB.

- a. MSB: the most significant bit, i.e. the most significant bit transmitted first in a sequence
- b. LSB: the least significant bit, i.e. the least significant bit transmitted first in a sequence

(8) Stop Bit

Set the stop bit for each data, click on the “Stop Bit” to select to 1 bit or 2 bits.

(9) Btrrate

When RS232 communication is asynchronous transmission communication, no accompanying clock signal during the data transmission process, in order to solve the determination of data bits, the protocol requires that the two sides of communication to agree on the bit rate.

Generally, the bit rate is defined as the number of bits that can be transmitted for 1 s time, for example, 9600 bps means that 9600 bits can be transmitted for 1 s. The bitrate is not directly equal to the effective data transmission rate. Note that the start bit, data bit, checksum and stop bit are all counted as bit bits, so the bitrate is not directly equal to the effective data rate. The oscilloscope will set the bitrate according to the bitrate form bit sampling.

Bitrate can be set to 2400 bps, 4800 bps, 9600 bps, 19200 bps, 38400 bps, 57600 bps, 115200 bps or custom. Pop up the numeric keyboard to set the custom bitrate.

It is recommended to make reasonable settings according to your RS232 communication hardware and software. Due to the basic model of this transmission protocol, RS232 protocol is usually used in short distance (less than 20 m), low speed (less than 1 Mbps) transmission occasions, and the communication outside of this range is susceptible to interference and becomes unreliable.

(10) Trigger Condition

- a. Start frame: The waveform will be generated on the start bit of RS232. When send a single string or send the same string several times, this trigger can be used to see a stable signal waveform, and if the sent data changes, the corresponding waveform will also be changed.
- b. Frame error: A 0 occurs in the stop state or a data error occurs in the middle of the data bit when receiving.
- c. Parity error: When RS232 has the parity bit, set the parity bit to 0 or 1 according to the Parity check method.



Odd Parity check: If the number of bit 1 is odd in the data bit and check parity bit, then the transmission is correct.

Even Parity check: If the number of bit 1 is even in the data bit and check parity bit, then the transmission is correct.

With this setting, the user can quickly locate and find the transmission process of parity error during the RS232 communication. It is useful for analyzing the fault.

- d. Data: The trigger will be generated when data acquired by the oscilloscope is the same as the custom 2 bits in hexadecimal. With this option, the user can quickly find the transmission signal that the specific data they are interested in.

Setup menu: data

- Data: The data is related to the frame length, double-click on the “Data” text field to pop up the numeric keyboard to set the data. For details on the use of the numeric keyboard, refer to the section of [5.8 Parameter Setting](#). Select this parameter and use the arrow key “ , ” below the Multipurpose rotary knob to move the selected cursor, then use the Multipurpose rotary knob to set the data. The data range can be set to 00 ~ FF.

8.15. I²C Trigger

I²C bus is two-wire serial bus and used to connect the microcontroller and peripheral device. It's widely applied in micro-electronics area.

(1) Trigger type

Press the **Menu** softkey in the trigger area on the front panel or tap the “T” trigger label on the top to enter the “Trigger” menu. Tap on the “Trigger type” to select “I²C”.

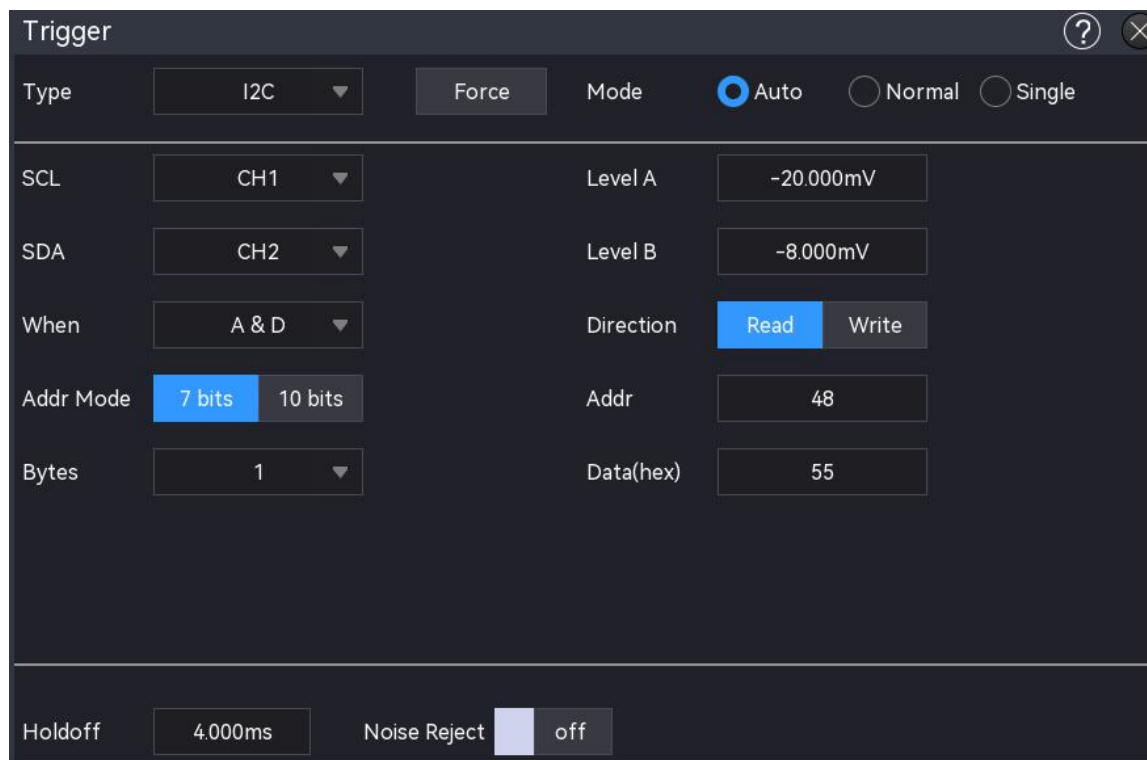

(2) Source

Set the clock source and the data source. The source can only be triggered stably when the selected channel has a connected signal and to be the trigger source.

a. Clock source

Click on the “Clock Source” to select CH1~CH4, D0~D15, and refer to the section of [Trigger Source](#) for more details. The current source is displayed in the trigger label on the top of the screen.

b. Data source

Click on the “Data Source” to select CH1~CH4, D0~D15, and refer to the section of [Trigger Source](#) for more details. The current source is displayed in the trigger label on the top of the screen.

(3) Level

Click on the “Level A, Level B”, and double-click on “Level” text field to pop up the numeric keyboard to set the trigger level; or rotate the [Multipurpose](#) rotary knob to adjust the trigger level; or press the trigger [Position](#) rotary knob to switch the selected Trigger level (the selected threshold is displayed in full line) and then rotate rotary knob to change the trigger level.

(4) Operating direction



Click on the “Operating Direction” to select “Read” or “Write”

- a. Write: It will be generated when I²C protocol "Read/write" bit is "Write".
- b. Read: It will be generated when I²C protocol "Read/write" bit is "Read".



(5) Trigger condition

- a. Start: I²C will be triggered on the start time, i.e. a falling edge occurs in SDA signal when SCL is in the high level.
- b. Restart: I²C will be triggered on the restart time, i.e. a start signal appears again after a start signal has appeared, but a stop has not appeared yet.
- c. Stop: I²C will be triggered on the stop bit, i.e. SDA signal goes from low to high when SCL is in the high level.
- d. Loss confirmed: In I²C protocol, every time after 8 bits information are transmitted, the data receiver needs to send an acknowledgement signal, which is the ACK bit in the above figure when the SCL is in the high level and the SDA signal is low. The loss trigger will occur while the SCL and SDA signal at the ACK bit are both high.
- e. Address: It will be generated when the communication address is the same with the user setting address. It can help the user to quickly locate the address transmission.

Setup menu: address length, address.

- Address length: Set the address bit width of I²C signal, click on the "Address Length" to select 7 bits or 10 bits.
 - Address: Set the trigger address, double-click on the "Address" text field to pop up the numeric keyboard to set the address. For details on the use of the numeric keyboard, refer to the section of [5.8 Parameter Setting](#). Use the arrow key ,  below the Multipurpose rotary knob to move the selected cursor and then use the Multipurpose rotary knob to change the address. The address range can be set to 00~FF, 000 ~ FFF.
- f. Data: The waveform will be generated when the data acquired by I²C is the same as the custom data. It can help the user to quickly find the transmission signal that the specific data they are interested in.

Setup menu: byte length, data.

- Byte length: Click on the "Byte Length" text field to set the byte length for the specified data. The byte length range can be set to 1 ~ 5.
- Data: The data is related to the frame length, double-click on the "Data" text field to pop up the numeric keyboard to set the data. For details on the use of the numeric keyboard, refer to the section of [5.8 Parameter Setting](#). Select this parameter and use the arrow key ", " below the Multipurpose rotary knob to move the selected cursor, then use the Multipurpose rotary knob to set the data. The data range can be set to 00

~ 00 ~ FFFFFFFF (10 F).

- g. Address & Data: It will be triggered when the same address is found during the transmission and the data relation is conform to the set condition. With this trigger condition, it can easily generate the specified address and data trigger of I²C and helpful for the user to analyze the transmission.

Setup menu: address length, address, byte length and data. For the setting of each parameter, refer to (5) Trigger condition “Address” and “Data” above.

8.16. SPI Trigger

- (1) Trigger type

Press the Menu softkey in the trigger area on the front panel or tap the “T” trigger label on the top to enter the “Trigger” menu. Tap on the “Trigger type” to select “SPI”.

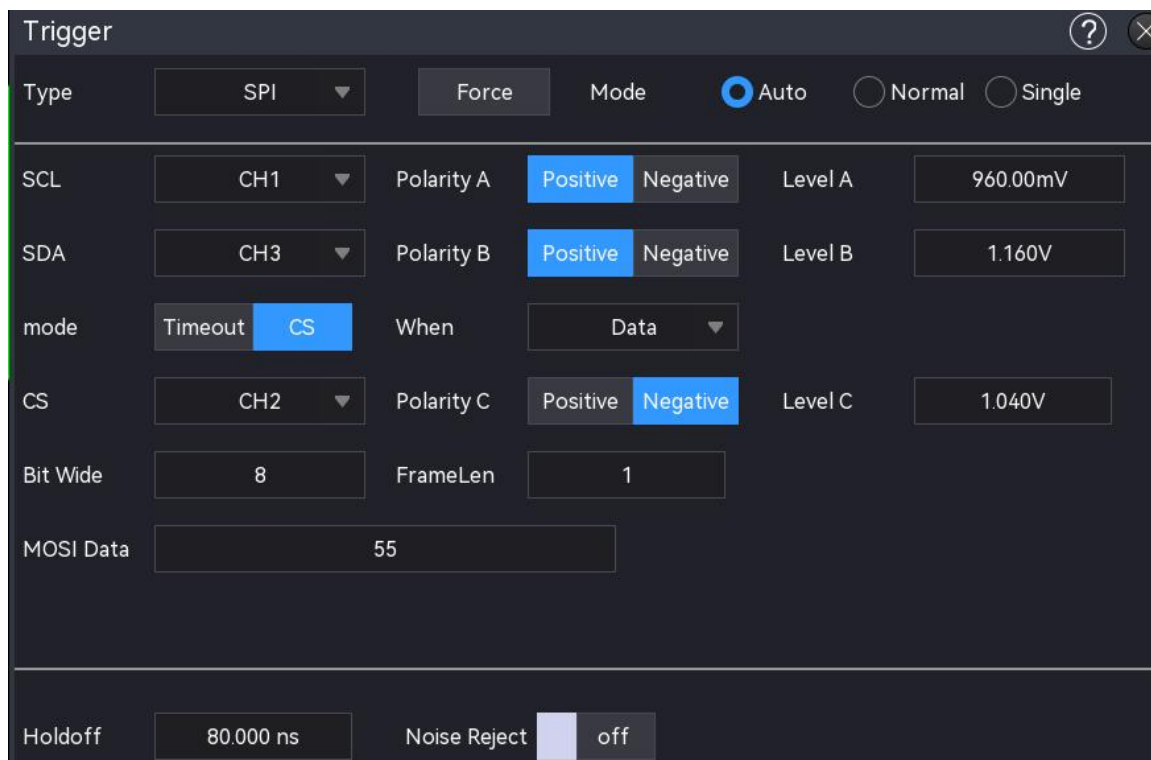

- (2) Source

Set the clock source, data source and CS (chip selection) source.

The source can only be triggered stably when the selected channel has a connected signal and to be the trigger source.

- a. Clock source

Click on the “Clock source” to select CH1~CH4, D0~D15, and refer to the section of [Trigger Source](#) for more details. The current source is displayed in the trigger label on the top of the screen.

b. Data source

Click on the “Data source” to select CH1~CH4, D0~D15, and refer to the section of [Trigger Source](#) for more details. The current source is displayed in the trigger label on the top of the screen.

c. CS (Chip Selection) Source

It can be set when the mode is CS. Click on the “Chip Selection Source” to select CH1~CH4, D0~D15, and refer to the section of [Trigger Source](#) for more details. The current source is displayed in the trigger label on the top of the screen.

(3) Edge

a. Clock polarity

Click on the “Clock Polarity” to select “Positive” or “Negative”.

Positive: Set to trigger on the positive of clock signal

Negative: Set to trigger on the negative of clock signal

b. CS polarity

It can be set when the mode is CS. Click on the “CS Polarity” to select “Positive” or “Negative”.

Positive: It is set to 1 if the signal is greater than the threshold, otherwise, it is 0.

Negative: It is set to 1 if 1 when the signal is less than the threshold, otherwise, it is 0.

c. Data polarity

Click on the “Data Polarity” to select “Positive” or “Negative”.

Positive: It is set to 1 if the signal is greater than the threshold, otherwise, it is 0.

Negative: It is set to 1 if 1 when the signal is less than the threshold, otherwise, it is 0.

(4) Level

Click on the “Level A, Level B, Level C”, and double-click on “Level” text field to pop up the numeric keyboard to set the trigger level; or rotate the [Multipurpose](#) rotary knob to adjust the trigger level; or press the trigger [Position](#) rotary knob to switch the selected trigger level (the selected threshold is displayed in full line) and then rotate the rotary knob to change the trigger level.

(5) Mode

Click on the “Mode” to select SPI and timeout, CS can be set.

■ Timeout: After the clock signal (CLK) remains idle for the specified time, the oscilloscope triggers when it searches for data that meets the trigger conditions (MISO).



■ CS: When the CS is valid, the oscilloscope triggers when it searches for data that meets the trigger conditions (SDA).

(6) Trigger Condition

Set the trigger condition for SPI, timeout and data can be set.

- a. Idle: A clock signal will be generated when the idle time meets the trigger condition.

Setup menu: Idle time



- Idle time: Double-click on the “Idle Time” text field to pop up the numeric keyboard to set the idle time. For details on the use of the numeric keyboard, refer to the section of [5.8 Parameter Setting](#). Use the arrow key ,  below the Multipurpose rotary knob to move the selected cursor and then use the Multipurpose rotary knob to change the idle time.

The idle time range can be set to 100 ns~1 s.

- b. Data: It will be generated when a clock signal meets the idle time and the data signal meets the data condition.

Timeout, data bit width, data can be set when the mode is timeout;

Data bit width, frame length, data can be set when the mode is CS.

- Idle time: Set the idle time, for the setting method, refer to “Idle time” above.
- Data bit width: Set the bit width for each unit in SPI protocol, double-click on the “Data Bit Width” text field to pop up the numeric keyboard to set the data bit width. For details on the use of the numeric keyboard, refer to the section of [5.8 Parameter Setting](#). Select this parameter and use the Multipurpose rotary knob to change the data bit width. The range of data bit width can be set to 4 ~ 32.
- Frame length: Set the length for data unit. Double click on the “Frame Length” text field to pop up the numeric keyboard to set the frame length. For details on the use of the numeric keyboard, refer to the section of [5.8 Parameter Setting](#). Select this parameter and use the Multipurpose rotary knob to change the frame length, it can be set to 1 ~ 32.
- Data: The data is related to the frame length, double-click on the “Data” text field to pop up the numeric keyboard to set the data. For details on the use of the numeric keyboard, refer to the section of [5.8 Parameter Setting](#). Select this parameter and use the arrow key “, ” below the Multipurpose rotary knob to move the selected cursor, then use the Multipurpose rotary knob to set the data. The data range can be set to 0 ~ FFFFFFFFFFFFFFFFFFFFFFFFFFFFFFFFFF (32 F).

8.17. CAN Trigger

- (1) Trigger type

Press the  softkey in the trigger area on the front panel or tap the “T” trigger label on the

top to enter the “Trigger” menu. Tap on the “Trigger type” to select “CAN”.

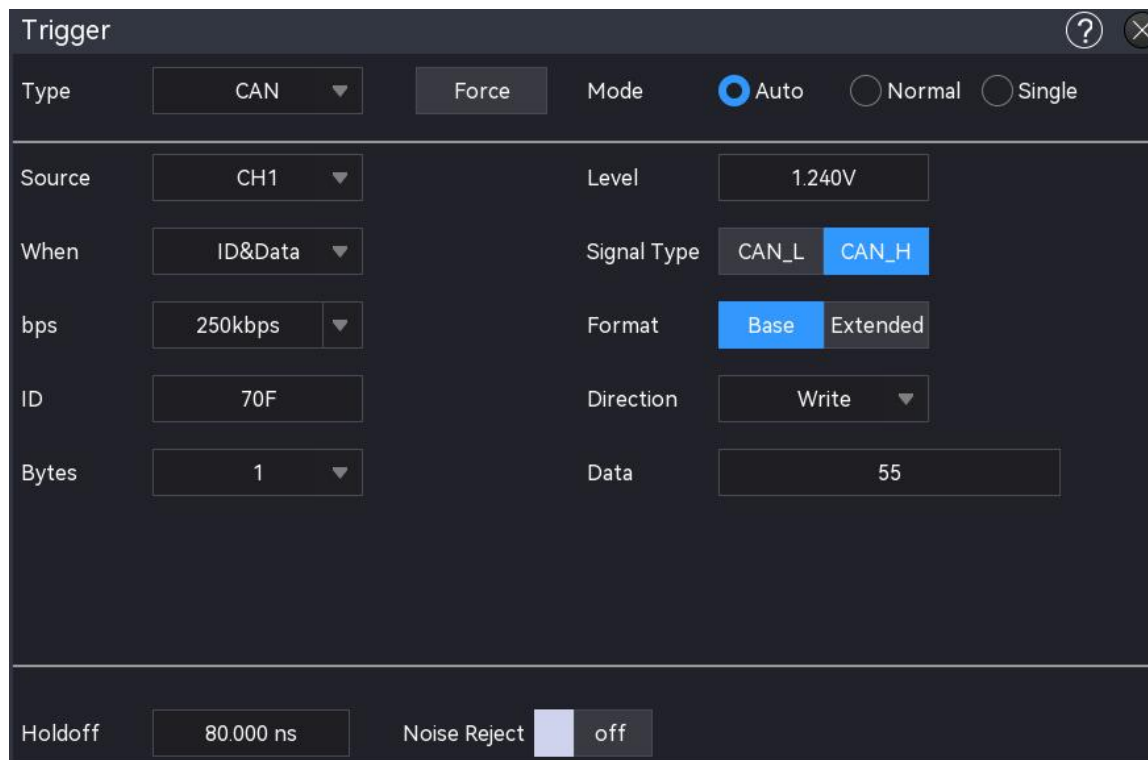

(2) Source

Click on the “Clock Source” to select CH1~CH4, D0~D15, and refer to the section of [Trigger Source](#) for more details. The current source is displayed in the trigger label on the top of the screen. The source can only be triggered stably when the selected channel has a connected signal and to be the trigger source.

(3) Level

Double-click on the “Level” text field to pop up the numeric keyboard to set the trigger level; or rotate the Multipurpose rotary knob to adjust the trigger level; or press the trigger Position rotary knob to change the trigger level.

When the trigger level is changed, a dotted line appears on the screen indicating the current trigger level. Once the change is stopped, the dotted line of the trigger level disappears after about 2 seconds.

(4) Signal type

Select whether the current signal accessed by the source is a high data line signal or a low data line signal. Click on the “Signal type” to select “CAN_H,” or “CAN_L “.

(5) Bitrate



Select the bitrate for CAN serial bus data, click on the “Bitrate” to select to 10 kbps, 19.2 kbps, 20 kbps, 33.3 kbps, 38.4 kbps, 50 kbps, 57.6 kbps, 62.5 kbps, 83.3 kbps, 100 kbps, 115.2 kbps, 125 kbps, 230.4 kbps, 250 kbps, 490.8 kbps, 500 kbps, 800 kbps, 921.6 kbps, 1 Mbps, 2 Mbps, 3 Mbps, 4 Mbps, 5 Mbps or custom.

If "Custom" is selected, a custom bitrate can be entered.

(6) Trigger Condition

- a. Start frame: The waveform is generated on the frame start of CAN signal.
- b. Data frame: Triggered on the data frame that match with CAN signal.
- c. Remote frame: Triggered on the remote frame
- d. Error frame: Triggered on the error frame of CAN signal.
- e. Overload frame: Triggered on the overload frame of CAN signal.
- f. Identifier: Triggered on the data frame that match with the specified ID.

Setup menu: identifier, frame format and direction.

- Identifier: Double-click on the "identifier" text field to pop up the numeric keyboard to set the identifier. For details on the use of the numeric keyboard, refer to the section of [5.8 Parameter Setting](#). Use the arrow key ,  below the Multipurpose rotary knob to move the selected cursor and then use the Multipurpose rotary knob to change the identifier. The address can be set to 000 ~ 7FF, 00000000 ~ 1FFFFFFF.

- Frame format: Click on the "Frame Format" to set the format to standard or extend. The different frame formats have different ID ranges.

- Direction: Click on the "Direction" to set the direction of the identifier.



Write: It will be generated when CAN protocol "Read/Write" bit is "Write".

Read: It will be generated when CAN protocol "Read/Write" bit is "Read".

Read or write: It will be generated when CAN protocol "Read/Write" bit is "Read or Write".

- g. Data: The waveform will be generated when the data acquired by CAN is the same as the custom data. It can help the user to quickly find the transmission signal that the specific data they are interested in.

Setup menu: byte length, data.

- Byte length: The different byte length has different data range. Click on the "Byte Length" text field to select the byte length, and the range can be set to 1~8.
 - Data: Set the trigger data, double-click on the "Data" text field to pop up the numeric keyboard to set the data. For details on the use of the numeric keyboard, refer to the section of [5.8 Parameter Setting](#). Select this parameter and use the arrow key ,  below the Multipurpose rotary knob to move the selected cursor, then use the Multipurpose rotary knob to change the data.
- h. ID& Data: Triggered on the data frame that match with the specified ID and data.
Setup menu: identifier, frame format, direction, byte length and data. For the setting of each parameter, refer to (6) Trigger condition "Identifier" and "Data" above.
 - i. End of frame: Triggered on the end of frame of CAN signal

- j. Loss confirmed: Triggered on the loss confirmed of CAN signal.
- k. Bit stuff error: In the segment that requires bit filling, the waveform will be triggered when continuous detect the error from the same level of 6 bits.

8.18. CAN-FD Trigger

(1) Trigger type

Press the **Menu** softkey on the front panel or tap the “T” trigger label on the top to enter the “Trigger” menu. Tap on the “Trigger type” to select “CAN-FD”.

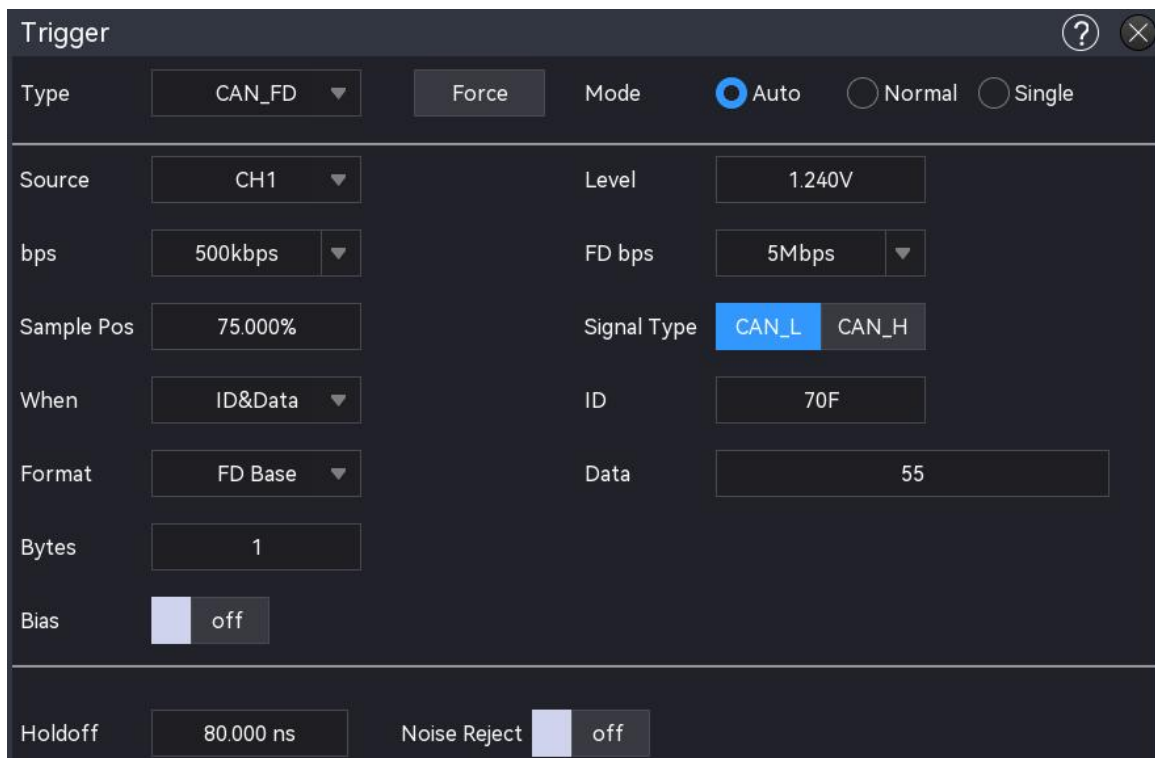

(2) Source

Click on the “Source” to select CH1~CH4 or D0~D15, and refer to the section of [Trigger Source](#) for more details. The current source is displayed in the trigger label on the top of the screen. The source can only be triggered stably when the selected channel has a connected signal and to be the trigger source.

(3) Level

Double-click on the “Level” text field to pop up the numeric keyboard to set the trigger level; rotate the [Multipurpose](#) rotary knob or rotate the trigger [Position](#) rotary knob to adjust the trigger level.

When the trigger level is changed, a dotted line appears on the screen indicating the current trigger level. Once the change is stopped, the dotted line of the trigger level disappears after about 2 seconds.

(4) Signal type

Set the source of the connect signal to "CAN_H" or "CAN_L".

(5) Bitrate (bps)

Select the bitrate for CAN-FD serial bus data, click on the "Bitrate" to select to 10 kbps, 19.2 kbps, 20 kbps, 33.3 kbps, 38.4 kbps, 50 kbps, 57.6 kbps, 62.5 kbps, 83.3 kbps, 100 kbps, 115.2 kbps, 125 kbps, 230.4 kbps, 250 kbps, 490.8 kbps, 500 kbps, 800 kbps, 921.6 kbps, 1 Mbps, 2 Mbps, 3 Mbps, 4 Mbps, 5 Mbps or custom.

If "Custom" is selected, a custom bitrate can be entered.

(6) FD bitrate

Select the FD bitrate for CAN-FD serial bus data, click on the "FD Bitrate" to select to 250 kbps, 500 kbps, 800 kbps, 1 Mbps, 1.5 Mbps, 2 Mbps, 4 Mbps, 5 Mbps, 6 Mbps, 8 Mbps or custom.

(7) Sampling position



The sample position is the point in the bit time where the oscilloscope samples the bit level. The sample position is expressed as a percentage of the "Time from bit start to sample point" and the "Bit time".

Click on the "Sampling position" text field to pop up the numeric keyboard to set the sampling position; or rotate the Multipurpose rotary knob to adjust the sampling position. The range can be set to or press the trigger 30% ~ 90%.

(8) Trigger Condition



- a. Frame start: The waveform is generated on the frame start of CAN-FD signal.
- b. Data frame: Triggered on the data frame that match with CAN-FD signal.
- c. Remote frame: Triggered on the remote frame.
- d. Error frame: Triggered on the error frame of CAN-FD signal.
- e. Overload frame: Triggered on the overload frame of CAN-FD signal.
- f. Identifier: Triggered on the data frame that match with the specified ID.

Setup menu: ID and frame format





- ID: Double-click on the "ID" text field to pop up the numeric keyboard to set the ID. For details on the use of the numeric keyboard, refer to the section of [5.8 Parameter Setting](#). Use the arrow key ,  below the Multipurpose rotary knob to move the selected cursor and then use the Multipurpose rotary knob to change the ID. The ID range can be set to 000 ~ 7FF, 00000000 ~ 1FFFFFFF.
- Frame format: Click on the "Frame Format" to set the format to standard, extend, FD standard or FD extend. The different frame formats have different ID ranges. The "Standard, extend" format is suitable for CAN signal. "FD standard, FD extend" format is suitable for CAN-FD signal.

- g. Data: The waveform will be generated when the data acquired by CAN-FD is the same as the custom data. It can help the user to quickly find the transmission signal that the specific data they are interested in.

Setup menu: byte length, data, offset and byte offset.

- Byte length: The different byte length has different data range. Double click on the "Byte Length" text field to pop up the numeric keyboard to set the byte length. For details on the use of the numeric keyboard, refer to the section of [5.8 Parameter Setting](#). Select this parameter and use the arrow key   below the Multipurpose rotary knob to move the selected cursor, then use the Multipurpose rotary knob to change the byte length.

The byte length range can be set to 1 ~ 16.

- Data: Set the trigger data, double-click on the "Data" text field to pop up the numeric keyboard to set the data. For details on the use of the numeric keyboard, refer to the section of [5.8 Parameter Setting](#). Select this parameter and use the arrow key   below the Multipurpose rotary knob to move the selected cursor, then use the Multipurpose rotary knob to change the data.
 - Offset: Set the data offset of byte data for delay trigger. Click on the "Offset" to switch on/off.
ON: Display the "Byte Offset" menu.
OFF: Hide the "Byte Offset" menu.
 - Byte offset: Double-click on the "Byte Offset" text field to pop up the numeric keyboard to set the byte offset. For details on the use of the numeric keyboard, refer to the section of [5.8 Parameter Setting](#). Select this parameter and use the arrow key   below the Multipurpose rotary knob to move the selected cursor, then use the Multipurpose rotary knob to change the byte offset. The byte offset range can be set to 0 ~ 63.
- h. ID& Data: Triggered on the data frame that match with the specified ID and data.
Setup menu: ID, frame format, byte length, data offset and byte offset. For the setting of each parameter, refer to (8) Trigger condition "Identifier" and "Data" above.
- i. End of frame: Triggered on the end of frame of CAN-FD signal.
- j. Loss confirmed: Triggered on the loss confirmed of CAN-FD signal.
- k. Bit stuff error: In the segment that requires bit filling, the waveform will be triggered when continuous detect the error from the same level of 6 bits.

8.19. LIN Trigger

(1) Trigger type

Press the **Menu** softkey on the front panel or tap the “T” trigger label on the top to enter the “Trigger” menu. Tap on the “Trigger type” to select “LIN”.

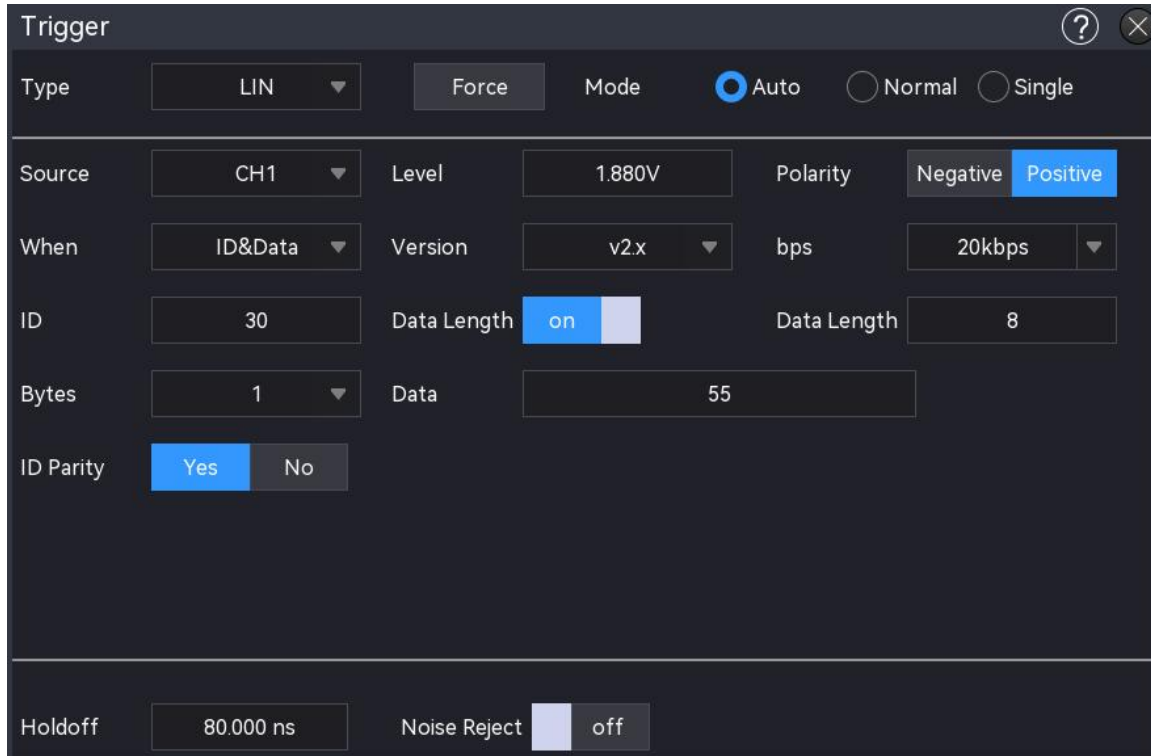

(2) Source

Click on the “Source” to select CH1~CH4 or D0~D15, and refer to the section of [Trigger Source](#) for more details. The current source is displayed in the trigger label on the top of the screen. The source can only be triggered stably when the selected channel has a connected signal and to be the trigger source.

(3) Polarity

Click on the “Polarity” to select the polarity to “Normal (high=1)” or “Reverse (high=0)”.

(4) Level

Double-click on the “Level” text field to pop up the numeric keyboard to set the trigger level; or rotate the [Multipurpose](#) rotary knob to adjust the trigger level.

When the trigger level is changed, a dotted line appears on the screen indicating the current trigger level. Once the change is stopped, the dotted line of the trigger level disappears after about 2 seconds.

(5) Version

Click on the “Version” to select the signal version to v1.x, v2.x or random.

(6) Bitrate (bps)

Select the bitrate for LIN, click on the "Bitrate" to select to 1.2 k, 2.4 k, 4.8 k, 9.6 k, 10.417 k, 19.2 k, 20 k or custom.

If "Custom" is selected, a custom bitrate can be entered.

(7) ID Parity check

Set ID Parity check to switch on/off.

ON: including parity bit and ID

OFF: not including parity bit and ID

(8) Data Length Menu

Set whether to display the data length menu, click on the "Data Length" to switch on/off.

ON: Display the data length menu

OFF: Hide the data length menu



(9) Data Length

Set LIN data length, double-click on the "Data Length" text field to pop up the numeric keyboard to set the data length. For details on the use of the numeric keyboard, refer to the section of [5.8 Parameter Setting](#). Select this parameter and use the Multipurpose rotary knob to change the data length. The data length can be set to 1~8. It is only available when the data length menu is displayed.

(10) Trigger Condition

- a. Synchronization: The oscilloscope will be generated when detect a synchronizing signal.
- b. Identifier: The oscilloscope will be generated when detect ID is equal to the setting frame.

Setup menu: ID

- ID: Double-click on "ID" text field to pop up the numeric keyboard to set the ID. For details on the use of the numeric keyboard, refer to the section of [5.8 Parameter Setting](#). Use the arrow key ,  below the Multipurpose rotary knob to move the selected cursor and then use the Multipurpose rotary knob to change the ID.



When ID including parity bit is set to "ON", the range is 00 ~ FF.

When ID including parity bit is set to "OFF", the range is 00 ~ 3F.

- c. Data: The waveform will be generated when the data is the same as the custom data. It can help the user to quickly find the transmission signal that the specific data they are interested in.

Setup menu: byte length, data.

- Byte length: The different byte length has different data range. Click on the "Data" text field to select the byte length, and the range can be set to 1~8.
- Data: Set the trigger data, double-click on the "Data" text field to pop up the numeric keyboard to set the data. For details on the use of the numeric keyboard. refer to the

section of [5.8 Parameter Setting](#). Select this parameter and use the arrow key ", 

below the Multipurpose rotary knob to move the selected cursor, then use the Multipurpose rotary knob to change the data. The data range can be set to 00 ~ FFFFFFFFFFFFFFFF.

- d. ID& Data: Triggered on the data frame that match with the specified ID and data.
Setup menu: ID, byte length and data. For the setting of each parameter, refer to (6) Trigger condition "Identifier" and "Data" above.
- e. Wake-up frame: Trigger on the wake-up frame of the signal.
- f. Sleep frame: Trigger on the sleep frame of the signal.
- g. Error: Trigger on the sleep frame of LIN signal.
Setup menu: error type
 - Error type: Click on the "Error type" to select synchronization, ID Parity check and checksum
 - Synchronization: synchronizing error
 - ID Parity check: ID Parity check error
 - Checksum: data check and error

8.20. FlexRay Trigger

(1) Trigger type

Press the  softkey on the front panel or tap the "T" trigger label on the top to enter the "Trigger" menu. Tap on the "Trigger type" to select "FlexRay".

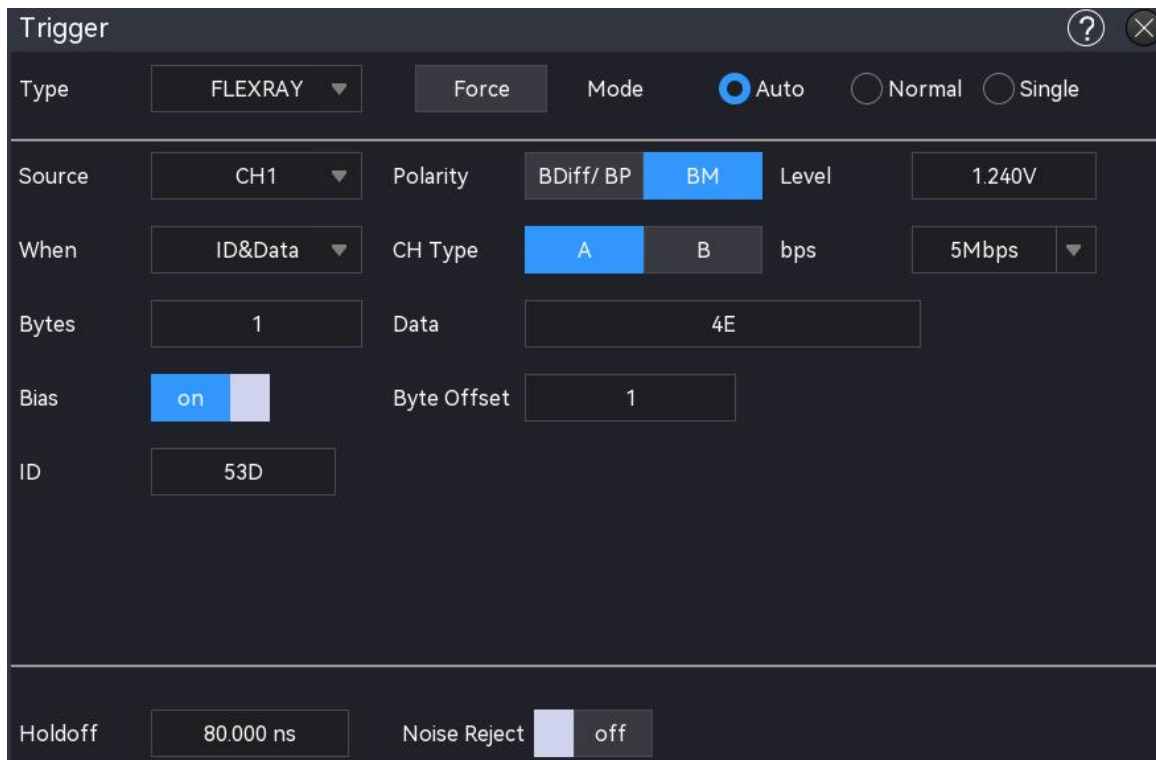

(2) Source

Click on the “Source” to select CH1~CH4 or D0~D15, and refer to the section of [Trigger Source](#) for more details. The current source is displayed in the trigger label on the top of the screen. The source can only be triggered stably when the selected channel has a connected signal and to be the trigger source.

(3) Polarity

Click on the “Polarity” to select BDiff, BP or BM.

(4) Level

Double-click on the “Level” text field to pop up the numeric keyboard to set the trigger level; rotate the [Multipurpose](#) rotary knob or rotate the trigger [Position](#) rotary knob to adjust the trigger level.

(5) Channel Type

Click on the “Channel Type” to select A or B.

(6) Bitrate

Click on the “Bitrate” to select to 2.5 M, 5 M, 10 M, or custom.

If "Custom" is selected, a custom bitrate can be entered.



(7) Trigger Condition

- a. Frame start: Triggered on the homing sequence
- b. Indicating bit: It will be triggered when acquired data is the same with the set indicating bit.



Setup menu: indicating bit

- Indicating bit: Set the indicating bit of FlexRay trigger, click on the “Indicating Bit” to set normal (01XX), static load (11XX), null (00XX), synchronization (XX10), start (XX11).
- c. Identifier: It will be triggered when acquired data is the same with the set the identifier.





Setup menu: ID



- ID: Double-click on the “ID” text field to pop up the numeric keyboard to set the data. For details on the use of the numeric keyboard, refer to the section of [5.8 Parameter Setting](#). Select this parameter and use the arrow key “ , ” below the Multipurpose rotary knob to move the selected cursor, then use the Multipurpose rotary knob to change the data. The ID range can be set to 000 ~ 7FF.
- d. Cycle number: It will be triggered when acquired cycle number is the same with the set cycle number.

Setup menu: cycle number

- Cycle number: Double-click on the “Cycle Number” text field to pop up the numeric keyboard to set the cycle number. For details on the use of the numeric keyboard, refer to the section of [5.8 Parameter Setting](#). Select this parameter and use the arrow key “ , ” below the Multipurpose rotary knob to move the selected cursor, then use the Multipurpose rotary knob to change the cycle number. The range of cycle number can be set to 00 ~ 3F.
- e. Header filed: It will be triggered when header filed is the same with the setting.



Setup menu: identifier bit, ID, static load, header CRC, cycle number

- Identifier bit: Double-click on the “identifier bit” text field to pop up the numeric keyboard to set the identifier bit. For details on the use of the numeric keyboard, refer to the section of [5.8 Parameter Setting](#). Select this parameter and use the arrow key “ , ” below the Multipurpose rotary knob to move the selected cursor, then use the Multipurpose rotary knob to change the identifier bit. The range of identifier bit can be set to 00 ~ 1F.
- ID: For setting ID, refer to Trigger Condition “Identifier” above.
- Static load: Double-click on the “Static Load Length” text field to pop up the numeric keyboard to set the static load length. For details on the use of the numeric keyboard, refer to the section of [5.8 Parameter Setting](#). Select this parameter and use the arrow key “ , ” below the Multipurpose rotary knob to move the selected cursor, then use the Multipurpose rotary knob to change the static load length. The range of static load length can be set to 00 ~ 7F.
- Header CRC: Double-click on the “Header CRC” text field to pop up the numeric

keyboard to set the header CRC. For details on the use of the numeric keyboard, refer to the section of [5.8 Parameter Setting](#). Select this parameter and use the arrow key “ , ” below the Multipurpose rotary knob to move the selected cursor, then use the Multipurpose rotary knob to change the header CRC. The range of header CRC can be set to 000 ~ 7FF.

- Cycle number: For setting the cycle number, refer to Trigger Condition “Cycle Number” above.
- f. Data: The waveform will be generated when the acquired data is the same as the custom data. It can help the user to quickly find the transmission signal that the specific data they are interested in.

Setup menu: byte length, offset, data and byte offset

- Byte length: The different byte length has different data range. Double-click on the “Byte Length” text field to pop up the numeric keyboard to set the byte length. For details on the use of the numeric keyboard, refer to the section of [5.8 Parameter Setting](#). Select this parameter and use the Multipurpose rotary knob to change the data. The range of byte length can be set to 1~16.
 - Offset: Click on the “Offset” text field to switch on/off.
 - Data: Double-click on the “Data” text field to pop up the numeric keyboard to set the data. For details on the use of the numeric keyboard, refer to the section of [5.8 Parameter Setting](#). Select this parameter and use the arrow key “ , ” below the Multipurpose rotary knob to move the selected cursor, then use the Multipurpose rotary knob to change the data. The byte length range can be set to 00~FFFFFFFFFFFFFFFFFFFFFFFFFFFFFFFF (32 F).
 - Byte offset: Set the byte offset and display the off-screen data on the screen. Double-click on the “Byte Offset” text field to pop up the numeric keyboard to set the byte offset. For details on the use of the numeric keyboard, refer to the section of [5.8 Parameter Setting](#). Select this parameter and use the Multipurpose rotary knob to change the byte offset. The range of byte offset can be set to 0 ~ 253.
- g. ID& Data: Triggered on the data frame that match with the specified ID and data.
Setup menu: ID, byte length, bias, data and byte offset. For the setting of each parameter, refer to trigger condition above.
- h. End of frame: Triggered on the end of frame of the oscilloscope.
Setup menu: frame type
- Frame type: Click on the “Frame Type” to select static, dynamic (DTS) and all.
 - Static frame: Triggered on the static frame

- Dynamic frame (DTS): Triggered on the dynamic frame
 - All: Triggered on the static and dynamic frame
- i. Error: The oscilloscope will be generated when the bus error occurred.
- Setup menu: error
- Error: Click on the “Error” to select header CRC, end of frame CRC, empty frame static error, empty dynamic error, synchronization frame and start frame.
- Header CRC: header CRC error of bus
 - End of frame CRC: end of frame CRC error of bus
 - Empty frame static error: empty frame static error of bus
 - Empty dynamic error: empty dynamic error of bus
 - Synchronization frame: The header frame of FlexRay has a dedicated indicating bit, the data frame will be the synchronization frame when the indicating bit is valid.
 - Frame start: The frame start of FlexRay has a dedicated indicating bit, the data frame will be the synchronization frame when the indicating bit is valid.

8.21. I2S Trigger

In I2S Trigger type, the oscilloscope identifies the trigger condition by looking for the specified data value, the serial clock line (SCLK, 1 pulse on the clock line for each bit of digital audio data sent), the frame clock line (WS, for switching the audio channel data), and the serial data line (SDA, for transmitting the audio data represented by the binary complement) should be set. The following figure shows the timing diagram of the I2S bus.

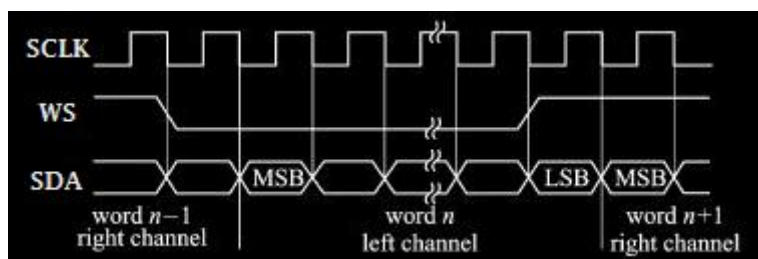

(1) Trigger type

Press the Menu softkey in the trigger area on the front panel or tap the “T” trigger label on the top to enter the “Trigger” menu. Tap on the “Trigger type” to select “I2S”.

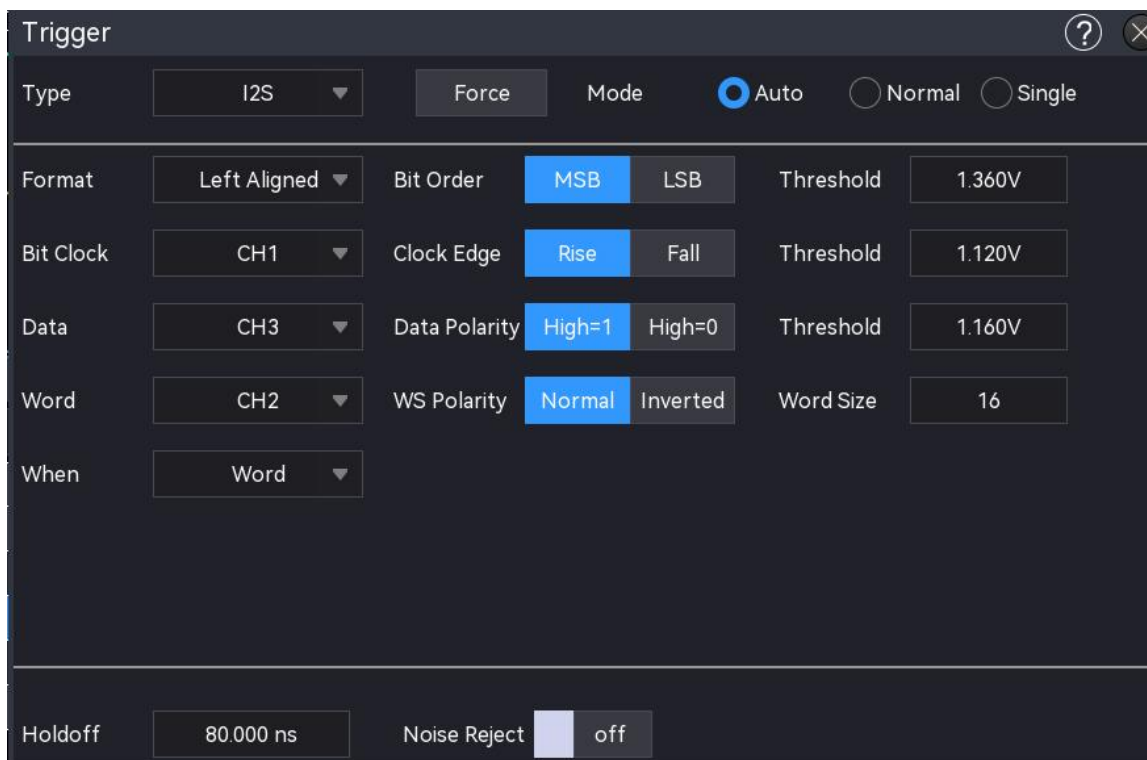

(2) Format

Click on the “Format” to select standard, left justifying, right justifying and TDM.

- Standard: MSB of each sampled data is sent first and the LSB is sent last. MSB is displayed on the SDATA line, which at one clock bit clock after the edge of WS transition.

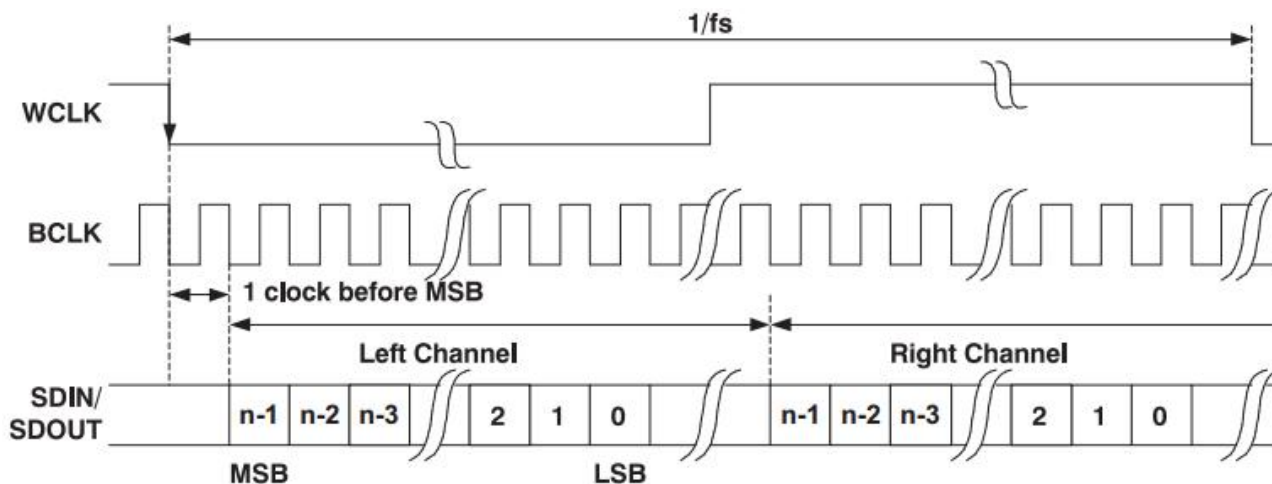

- Left justifying: Data transmission (MSB first) starts at the edge of the WS conversion (without the one bit delay used by the standard format).

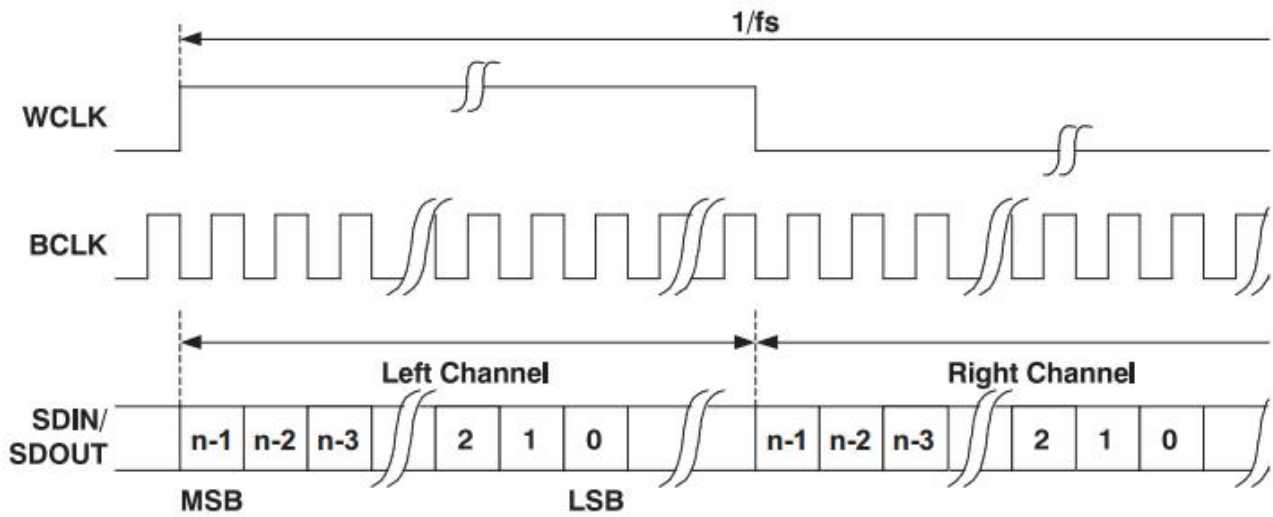

- Right justifying: Data transmission (MSB first) is right justifying with WS.

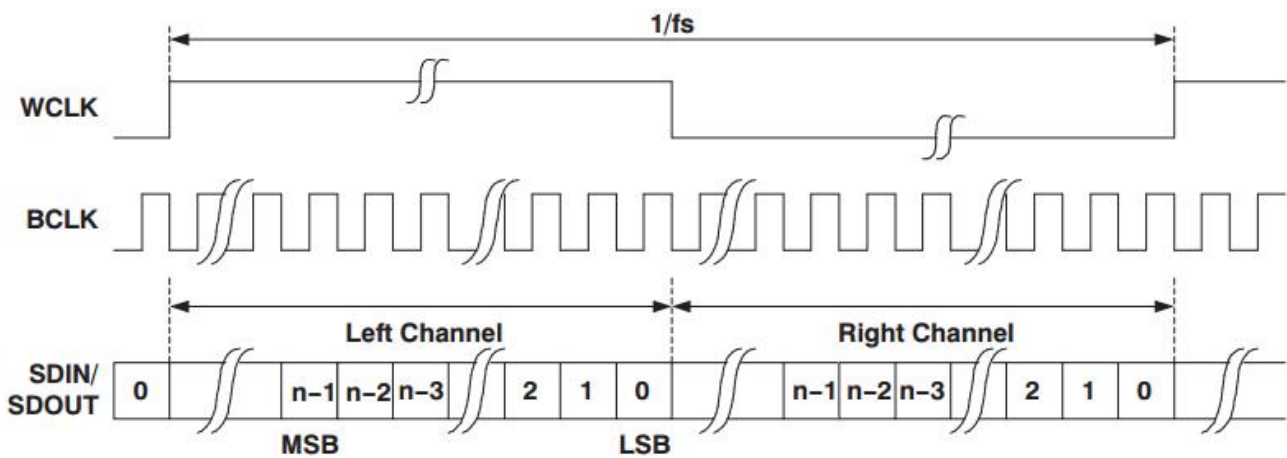

- TDM: (time division multiplexing) mode can transmit multi-channel data.

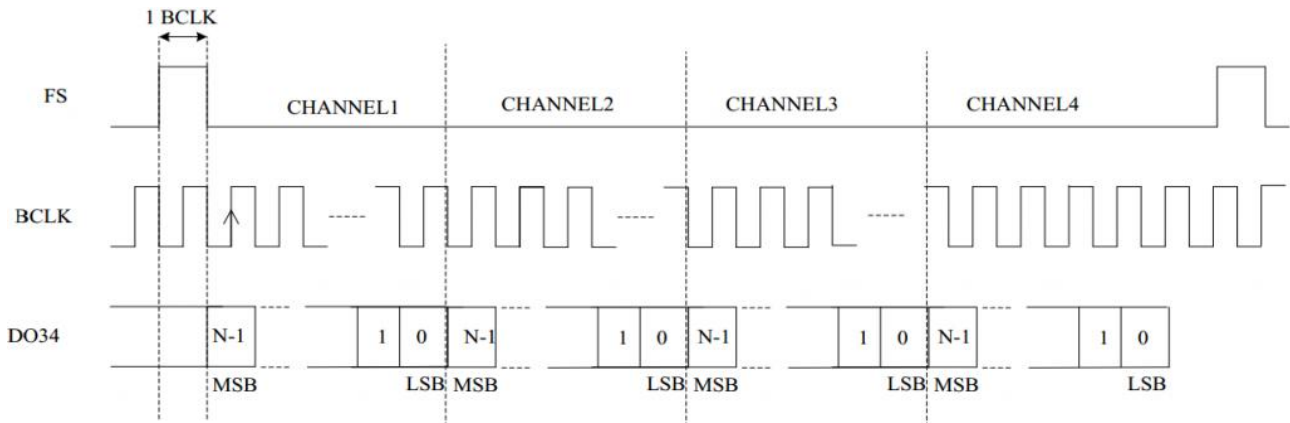

(3) Bit Sequence

Click on the “Bit Sequence” to select “LSB” or “MSB”, the default is “MSB”.

(4) Source

Set the bit clock, bit selection and data source. The source can only be triggered stably when the selected channel has a connected signal and to be the trigger source.

a. Bit clock

Click on the “Bit Clock” to select CH1~CH4, D0~D15, and refer to the section of [Trigger](#)

[Source](#) for more details. The current source is displayed in the trigger label on the top of the screen. The clock line (SCLK) provides the clock signal for synchronizing audio data transmission.

b. Bit selection

Click on the “Bit Clock” to select CH1~CH4, D0~D15, and refer to the section of [Trigger Source](#) for more details. The current source is displayed in the trigger label on the top of the screen. The bit selection indicates the audio data of the current transmission is left channel or right channel.

c. Data

Click on the “Data” to select CH1~CH4, D0~D15, and refer to the section of [Trigger Source](#) for more details. The current source is displayed in the trigger label on the top of the screen. The data line is used to transmit the actual audio data.

(5) Edge

a. Clock edge

Click on the “Clock” to select “Rising/Falling” edge

Rising edge: Sampling SDA on the rising edge of clock

Falling edge: Sampling SDA on the falling edge of clock

b. WS polarity

Click on the “WS Polarity” to select “Normal” or “Reverse”. The WS polarity determines the valid level for the bit selection signal. The bit selection signal indicates the frame start and end of frame for the audio data.

c. Data polarity

Click on the “Data Polarity” to select “high=1” or “high=0”.

(6) Level

Click on the “Level A, Level B, Level C”, and double-click on “Level” text field to pop up the numeric keyboard to set the trigger level; or rotate the [Multipurpose](#) rotary knob to adjust the trigger level; or press the trigger [Position](#) rotary knob to switch the selected trigger level (the selected threshold is displayed in full line) and then rotate the rotary knob to change the trigger level.

(7) Data Format (not TDM)

The data format: standard, left justifying, right justifying

Setup menu: bit size, trigger mode

a. Bit size

The bit size can be set when the format is standard, left justifying or right justifying.

Double-click on the “Bit Size” text field to pop up the numeric keyboard to set the bit size.



For details on the use of the numeric keyboard, refer to the section of [5.8 Parameter Setting](#). Select this parameter and use the Multipurpose rotary knob to change the bit size. The range of bit size can be set to 4~32.

b. Trigger mode

- Bit selection: Triggered on the bit selection
- Data: It will be generated when the data meets the setting value in the sound channel.

Setup menu: audio and data

- Audio: Click on the "Audio" to select to any, left channel or right channel

- Data: Double-click on the "Data" text field to pop up the numeric keyboard to set the bit size. For details on the use of the numeric keyboard, refer to the section of [5.8 Parameter Setting](#). Select this parameter and use the arrow key ", " below the Multipurpose rotary knob to move the selected cursor, then use the Multipurpose rotary knob to change the data.

(8) Data Format (TDM)

When the format is standard, left justifying, right justifying, data bit per channel, clock bit per channel, channel number per frame, bit delay and trigger condition (frame synchronizing, data, channel and data) can be set.

a. Data bit per channel

Double-click on the "Data bit per channel" text field to pop up the numeric keyboard to set this value. For details on the use of the numeric keyboard, refer to the section of [5.8 Parameter Setting](#). Select this parameter and use the Multipurpose rotary knob to change this value. The range is available form 4~32.

The set value of each channel data bit \leq the set value of each channel clock bit.

b. Clock bit per channel

Double-click on the "Clock bit per channel" text field to pop up the numeric keyboard to set this value. For details on the use of the numeric keyboard, refer to the section of [5.8 Parameter Setting](#). Select this parameter and use the Multipurpose rotary knob to change this value. The range is avblible form 4~32.

c. Channel number per frame

Double-click on the "Clock bit per channel" text field to pop up the numeric keyboard to set this value. For details on the use of the numeric keyboard, refer to the section of [5.8 Parameter Setting](#). Select this parameter and use the Multipurpose rotary knob to change this value. The range is avblible form 2 ~ 64.

d. Bit delay

Double-click on the "Bit delay" text field to pop up the numeric keyboard to set this value.

For details on the use of the numeric keyboard, refer to the section of [5.8 Parameter Setting](#). Select this parameter and use the [Multipurpose](#) rotary knob to change this value. The range is available from 0 ~ 31.

The set value of bit delay < The set value of each channel clock bit

e. Trigger condition

- Synchronization frame: Triggered on synchronization frame
- Data: It will be generated when the data meets the setting value.

Setup menu: data

- Data: Double-click on the "Data" text field to pop up the numeric keyboard to set the data.

For details on the use of the numeric keyboard, refer to the section of [5.8 Parameter Setting](#). Select this parameter and use the [Multipurpose](#) rotary knob to change the data.

- Channel and data: It will be generated when the channel and data meets the setting value.

Setup menu: channel, data

- Channel: Double-click on the "Channel" text field to pop up the numeric keyboard to set the channel number. For details on the use of the numeric keyboard, refer to the section of [5.8 Parameter Setting](#). Select this parameter and use the [Multipurpose](#) rotary knob to change the channel number.

- Data: Double-click on the "Data" text field to pop up the numeric keyboard to set the data.

For details on the use of the numeric keyboard, refer to the section of [5.8 Parameter Setting](#). Select this parameter and use the [Multipurpose](#) rotary knob to change the data.

8.22. 1553B Trigger

(1) Trigger type

Press the Menu softkey in the trigger area on the front panel or tap the "T" trigger label on the top to enter the "Trigger" menu. Tap on the "Trigger type" to select "1553B".

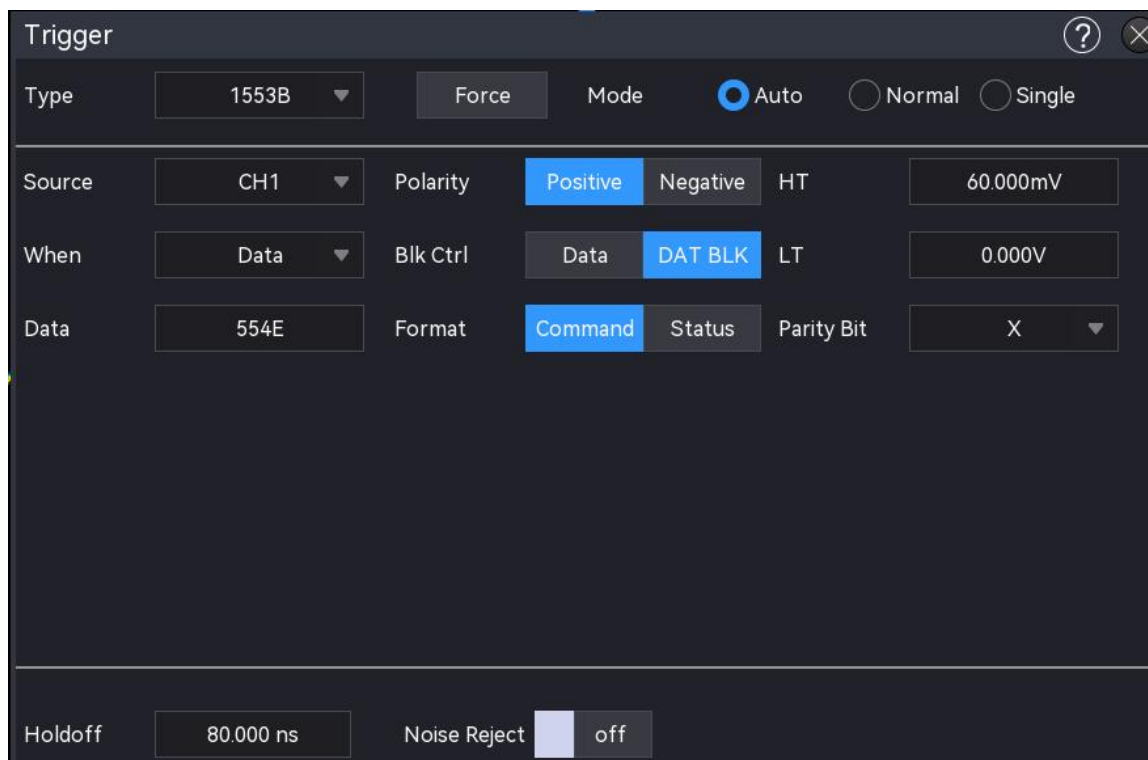

(2) Source

Click on the “Clock Source” to select CH1~CH4, D0~D15, and refer to the section of [Trigger Source](#) for more details. The current source is displayed in the trigger label on the top of the screen.

The source can only be triggered stably when the selected channel has a connected signal and to be the trigger source.

(3) Polarity

Click on the “Polarity” to select “Positive” or “Negative”.

(4) High/Low Level

Double-click on “High Level (Low Level)” text field to pop up the numeric keyboard to set the threshold; or rotate the [Multipurpose](#) rotary knob to adjust the threshold; or press the trigger [Position](#) rotary knob to switch the threshold and rotate the rotary knob (the selected threshold is displayed in full line) to change the threshold.

(5) Format

Click on the “Format” to set command word or state word.

If the format is the command word, the “state” trigger condition will be hidden.









If the format is the state word, the “command” trigger condition will be hidden.

(6) Trigger Condition

- a. Synchronization: Triggered on when detects a synchronization signal.
- b. Command: Triggered on when the command is totally match with the set parameters.



Setup menu: terminal address. T/R bit. sub-address/mode. word count/code and Parity

check.

- Terminal address: Set the terminal address for a command word, double-click on the “Terminal Address” text field to pop up the numeric keyboard to set the terminal address. For details on the use of the numeric keyboard, refer to the section of [5.8 Parameter Setting](#). Use the arrow key ,  below the Multipurpose rotary knob to move the selected cursor and then use the Multipurpose rotary knob to change the terminal address.
 - T/R bit: Select the “T/R Bit” to set X, 0 (R) or 1 (T), the default is X.
 - Sub-address/mode: Set the sub-address for a command word, double-click on the “Sub-address” text field to pop up the numeric keyboard to set the sub-address. For details on the use of the numeric keyboard, refer to the section of [5.8 Parameter Setting](#). Use the arrow key ,  below the Multipurpose rotary knob to move the selected cursor and then use the Multipurpose rotary knob to change the sub-address.
 - Word count/code: Set the word count/code for a command word, double-click on the “Word count/code” text field to pop up the numeric keyboard to set the word count/code. For details on the use of the numeric keyboard, refer to the section of [5.8 Parameter Setting](#). Use the arrow key ,  below the Multipurpose rotary knob to move the selected cursor and then use the Multipurpose rotary knob to change the word count/code.
 - Parity check: Select the “Parity check” to set X, 0 or 1, the default is X.
- c. State: Triggered on when the state word is totally match with the set parameters.
- Setup menu: terminal address, error message (9), Instr (10), service request (11), BCR (15), Busy (16), system flag (17), DBCA (18), terminal flag (19) and Parity check.
- Terminal address: Set the terminal address for a state word, double-click on the “Terminal Address” text field to pop up the numeric keyboard to set the terminal address. For details on the use of the numeric keyboard, refer to the section of [5.8 Parameter Setting](#). Use the arrow key ,  below the Multipurpose rotary knob to move the selected cursor and then use the Multipurpose rotary knob to change the terminal address.
 - Error message (9): Select the “Error message (9)” to set X, 0 or 1, the default is X.
 - Instr(10): Select the “Instr (10)” to set X, 0 or 1, the default is X.
 - Service request (11): Select the “Service request (11)” to set X, 0 or 1, the default is X.
 - BCR (15): Select the “BCR(15)” to set X, 0 or 1, the default is X.
 - Busy (16): Select the “Busy (16)” to set X, 0 or 1, the default is X.

- System flag (17): Select the “System flag (17)” to set X, 0 or 1, the default is X.
 - DBCA (18): Select the “DBCA (18)” to set X, 0 or 1, the default is X.
 - Terminal flag (19): Select the “Terminal flag (19)” to set X, 0 or 1, the default is X.
 - Parity check: Select the “Parity check” to set X, 0 or 1, the default is X.
- d. Data: Triggered on when the data word is totally match with the set parameters.

Setup menu: data, Parity check

- Data: Triggered on the specified data word, double-click on the “Data” text field to pop up the numeric keyboard to set the data. For details on the use of the numeric keyboard, refer to the section of [5.8 Parameter Setting](#). Use the arrow key ,  below the Multipurpose rotary knob to move the selected cursor and then use the Multipurpose rotary knob to change the data.
 - Parity check: Select the “Parity check” to set X, 0 or 1, the default is X.
- e. Error: Triggered on the specified error type.

Setup menu: error type (Parity check, synchronization, Manchester, non-continuous data)

- Parity check: Triggered on when odd (even) Parity check is incorrect for the data in the word
- Synchronization: Triggered on when finds invalid synchronizing pulse
- Manchester: Triggered on when detects Manchester error
- Non-continuous data: Triggered on when detects non-continuous data

8.23. Manchester Trigger

(1) Trigger type

Press the  softkey on the front panel or tap the “T” trigger label on the top to enter the “Trigger” menu. Tap on the “Trigger type” to select “Manchester”.

(2) Source

Click on the “Source” to select CH1~CH4 or D0~D15, and refer to the section of [Trigger Source](#) for more details. The current source is displayed in the trigger label on the top of the screen. The source can only be triggered stably when the selected channel has a connected signal and to be the trigger source.

(3) Polarity

Click on the “Polarity” to select positive or negative.

(4) Level

Double-click on the “Level” text field to pop up the numeric keyboard to set the trigger level; or rotate the [Multipurpose](#) rotary knob to adjust the trigger level; or press the trigger [Position](#) rotary knob to change the trigger level.

(5) Encode Mode

Click on the “Encode Mode” to switch to IEEE or G.E.

- IEEE: “1” indicates that a jump from low to high; “0” indicates that a jump from high to low.
- G.E: “1” indicates that a jump from low to high; “0” indicates that a jump from high to low.

(6) Bitrate

Click on the “Bitrate” to select the bitrate of DUT to 1.2 kbps, 2.4 kbps, 4.8 kbps, 9.6 kbps, 10.417 kbps, 19.2 kbps, 125 kbps, 250 kbps, 500 kbps, 1Mbps, 2Mbps, 5Mbps, 10Mbps or custom. The custom baud bitrate match with the DUT, the default bitrate is 1.2 kbps.

(7) Bit Sequence

Click on the “Bit Sequence” to switch to MSB or LSB.

- MSB: the most significant bit, i.e. the most significant bit transmitted first in a sequence
- LSB: the least significant bit, i.e. the least significant bit transmitted first in a sequence

(8) Idle State



Click on the “Idle State” to switch to 0 or 1.

- 0: The bus state is low level when no data is present.
- 1: The bus state is high level when no data is present.

(9) Trigger Condition



- a. Frame start: Triggered on the frame start
- b. Header field: The header field will be triggered when the condition is met.

Setup menu: header field

- Header field: Set the trigger data for the header field, the data length is limited by the length of “Header field”. Double-click on “Header field” text field to pop up the numeric keyboard to set the header field. For details on the use of the numeric keyboard, refer to the section of [5.8 Parameter Setting](#). Select this parameter and use the arrow key “”, “” below the Multipurpose rotary knob to move the selected cursor, then use the Multipurpose rotary knob to change the header field.



- c. Data field: The data field will be triggered when the condition is met.

Setup menu: data field

- Data field: Set the trigger data for the data field, the data length is limited by the “Data bit” and “Bit size”. Double-click on “Data field” text field to pop up the numeric keyboard to set the data field. For details on the use of the numeric keyboard, refer to the section of [5.8 Parameter Setting](#). Select this parameter and use the arrow key “”, “” below the Multipurpose rotary knob to move the selected cursor, then use the Multipurpose rotary knob to change the data field.

- d. End field: The end field will be triggered when the condition is met.

Setup menu: end field

- End field: Set the trigger data for the end field, the data length is limited by the “End field”. Double-click on “End field” text field to pop up the numeric keyboard to set the end field. For details on the use of the numeric keyboard, refer to the section of [5.8 Parameter Setting](#). Select this parameter and use the arrow key “”, “” below the Multipurpose rotary knob to move the selected cursor, then use the Multipurpose rotary knob to change the end field.

e. Error field: Triggered on the error field

(10) Frame start bit

Click on the “Frame start bit” text field to pop up the numeric keyboard to enter the start bit. For details on the use of the numeric keyboard, refer to the section of [5.8 Parameter Setting](#). Select this parameter and use the Multipurpose rotary knob to change the start bit. The range can be set to 1~32.

(11) Synchronization field

Click on the “Synchronization field” text field to pop up the numeric keyboard to enter the synchronization field. For details on the use of the numeric keyboard, refer to the section of [5.8 Parameter Setting](#). Select this parameter and use the Multipurpose rotary knob to change the synchronization field. The range can be set to 0~32.

(12) Middle field 1

Click on the “Middle field 1” text field to pop up the numeric keyboard to enter the middle field 1. For details on the use of the numeric keyboard, refer to the section of [5.8 Parameter Setting](#). Select this parameter and use the Multipurpose rotary knob to change the middle field 1. The range can be set to 0~32.

(13) Header field

Click on “Header field” text field to pop up the numeric keyboard to enter the header field. For details on the use of the numeric keyboard, refer to the section of [5.8 Parameter Setting](#). Select this parameter and use the Multipurpose rotary knob to change the header field. The range can be set to 0~32.

(14) Middle field 2

Click on the “Middle field 2” text field to pop up the numeric keyboard to enter the middle field 2. For details on the use of the numeric keyboard, refer to the section of [5.8 Parameter Setting](#). Select this parameter and use the Multipurpose rotary knob to change the middle field 1. The range can be set to 0~32.

(15) Data bit

Click on the “Data bit” text field to pop up the numeric keyboard to enter the data bit. For details on the use of the numeric keyboard, refer to the section of [5.8 Parameter Setting](#). Select this parameter and use the Multipurpose rotary knob to change the data bit. The range can be set to 1~255.

(16) Bit size

Click on the “Bit size” text field to pop up the numeric keyboard to enter the bit size. For details on the use of the numeric keyboard, refer to the section of [5.8 Parameter Setting](#). Select this

parameter and use the Multipurpose rotary knob to change the bit size. The range can be set to 1~8.

(17) Middle field 3

Click on the “Middle field 3” text field to pop up the numeric keyboard to enter the middle field 3. For details on the use of the numeric keyboard, refer to the section of [5.8 Parameter Setting](#). Select this parameter and use the Multipurpose rotary knob to change the middle field 3. The range can be set to 0~32.

(18) End field

Click on the “End field” text field to pop up the numeric keyboard to enter the end field. For details on the use of the numeric keyboard, refer to the section of [5.8 Parameter Setting](#). Select this parameter and use the Multipurpose rotary knob to change the end field. The range can be set to 0~32.

(19) Inter-frame space

Click on the “Inter-frame space” text field to pop up the numeric keyboard to enter the inter-frame space. For details on the use of the numeric keyboard, refer to the section of [5.8 Parameter Setting](#). Select this parameter and use the Multipurpose rotary knob to change the inter-frame space. The range can be set to 0~32.

8.24. SENT Trigger

(1) Trigger type

Press the softkey on the front panel or tap the “T” trigger label on the top to enter the “Trigger” menu. Tap on the “Trigger type” to select “SENT”.

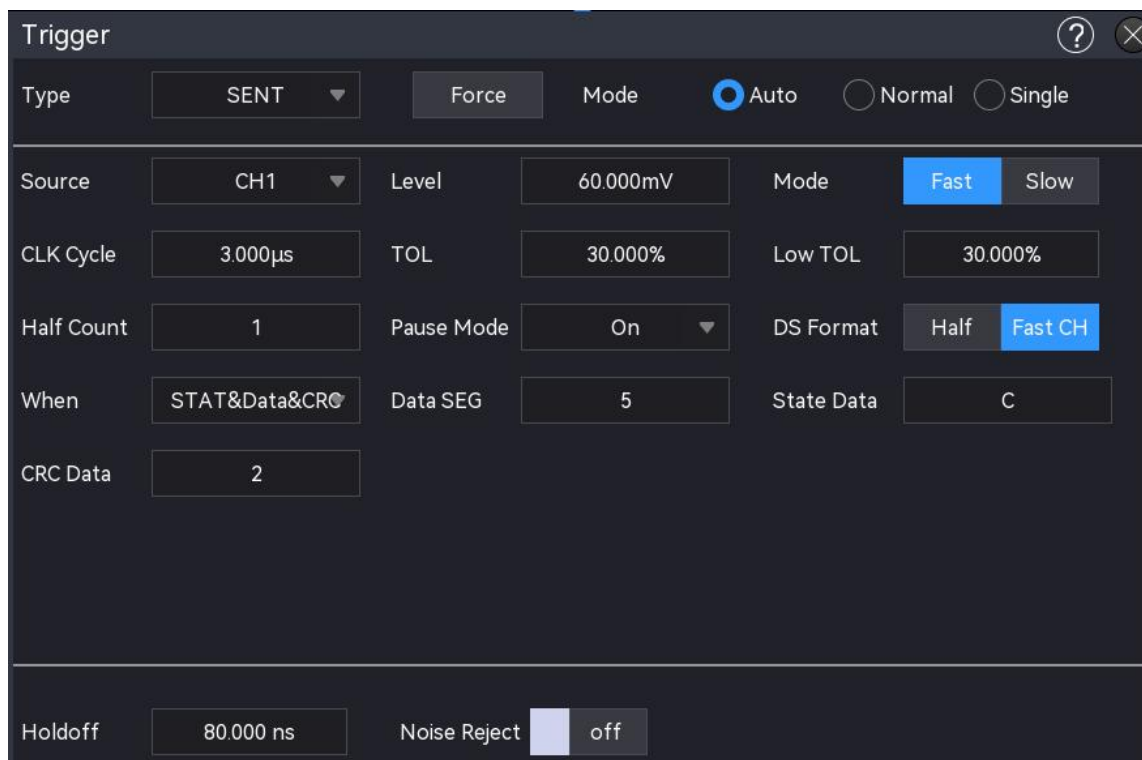

(2) Source

Click on the “Source” to select CH1~CH4 or D0~D15, and refer to the section of [Trigger Source](#) for more details. The current source is displayed in the trigger label on the top of the screen. The source can only be triggered stably when the selected channel has a connected signal and to be the trigger source.

(3) Level

Double-click on the “Level” text field to pop up the numeric keyboard to set the trigger level; or rotate the [Multipurpose](#) rotary knob to adjust the trigger level; or press the trigger [Position](#) rotary knob to change the trigger level.

(4) Clock period

Tap to select the “Clock period” and use the [Multipurpose](#) rotary knob to change the clock period; or double-click on the “Clock period” text field to pop up the numeric keyboard to set the clock period. For details on the use of the numeric keyboard, refer to the section of [5.8 Parameter Setting](#).

(5) Tolerance

Set the percentage tolerance to specify a percentage tolerance for determining whether the sync pulse is valid for decoding data. If the time of the measured sync pulse is within the percentage tolerance of the rated clock period, then the decoding will continue, otherwise, the sync pulse occurs an error and data decoding will not be performed. The tolerance range can be set to 3%~30%.

(6) Half byte

Set the half byte for fast channel message, double-click on “Half byte” text field to pop up the numeric keyboard to set the half byte; or rotate the Multipurpose rotary knob to adjust the half byte ; or press the trigger Position rotary knob to change the half byte.

(7) Pause mode

Click on the “Pause mode” to set whether there is a pause pulse between the fast channel messages. It can be switched to ON or OFF.

- OFF : There is no pause pulse between the fast channel messages.

There is no idle time on the SENT serial bus without pause pulses. This means that during normal operation the fast channel decode line shows a continuous stream of packets, i.e. one packet closes and a new packet opens immediately.

- ON: Add a pause pulse between the fast channel messages, so that the frames arrive at equal intervals.

If there is a pause pulse (switch on), the idle time will display between the messaged.

(8) Mode

Click on the “Mode” to switch the trigger signal mode to fast or slow.

(9) Trigger condition

The trigger condition can be set when the fast mode is selected, i.e. set the trigger condition under SENT fast mode.

Setup menu: synchronization, state, data, CRC, state and data, state+data+CRC, fast CRC error and continuous pulse error.

- a. Synchronization: Triggered on synchronization data
- b. State: The state will be triggered when the condition is met.

Setup menu: state data



- State data: Double-click on the “state data” text field to pop up the numeric keyboard to enter the state data. For details on the use of the numeric keyboard, refer to the section of [5.8 Parameter Setting](#). Select this parameter and use the Multipurpose rotary knob to change the state data.

- c. Data: Data will be triggered when the condition is met.

Setup menu: half byte, data field and data field format

- Half byte: Double-click on the “Half byte” text field to pop up the numeric keyboard to set the half byte. For details on the use of the numeric keyboard, refer to the section of [5.8 Parameter Setting](#). Select this parameter and use the Multipurpose rotary knob to change the half byte.

- Data field: Double-click on the “Data field” text field to pop up the numeric keyboard to set the data field. For details on the use of the numeric keyboard, refer to the section

of [5.8 Parameter Setting](#). Select this parameter and use the arrow key “”, “” below the Multipurpose rotary knob to move the selected cursor, then use the Multipurpose rotary knob to change the data field.

- Data field format: Click on the “Data field format” to half byte or fast channel.
 - Half byte: to be triggered according to the set “half byte”
 - Fast channel: to be triggered by the fast channel data field
- d. CRC: CRC data will be triggered when the condition is met.
- Setup menu: CRC data
- CRC data: Double-click on the “CRC data” text field to pop up the numeric keyboard to set the CRC data. For details on the use of the numeric keyboard, refer to the section of [5.8 Parameter Setting](#). Select this parameter and use the Multipurpose rotary knob to change the CRC data.
- e. State and data: It will be triggered when the state and data meet the condition.
- Setup menu: half byte, data field, data field format and state data. For the setting of each parameter, refer to (9) Trigger condition “State”, “Data” above.
- f. State + data + CRC: It will be triggered when the state, data and CRC meet the condition.
- Setup menu: half byte, data field, data field format, state data and CRC data. For the setting of each parameter, refer to (9) Trigger condition “State”, “Data” and “CRC” above.
- g. Fast CRC error: Triggered on fast CRC error.
- h. Continuous pulse error: Triggered on continuous pulse error.

(10) Frame type

“Frame type” can be set when the mode is slow. Click on the “Frame type” to switch the trigger signal mode.

(11) Trigger condition of slow speed





“Trigger condition of slow speed” can be set when the mode is slow, i.e. set the trigger condition for slow SENT signal.

Setup menu: synchronization, short ID, short data, short CRC, short ID and data, enhance ID, enhance data, enhance CRC, enhance ID and data, and slow channel CRC error

- a. Synchronization: Triggered on synchronization data.
- b. Short ID: It will be triggered when short ID meet the condition.

Setup menu: short ID

- Short ID: Double-click on the “Short ID” text field to pop up the numeric keyboard to set the short ID. For details on the use of the numeric keyboard, refer to the section of [5.8 Parameter Setting](#). Select this parameter and use the Multipurpose rotary knob to change the short ID.

- c. Short data: It will be triggered when short data meet the condition.
Setup menu: short data
- Short data: Double-click on the “Short data” text field to pop up the numeric keyboard to set the short data. For details on the use of the numeric keyboard, refer to the section of [5.8 Parameter Setting](#). Select this parameter and use the Multipurpose rotary knob to change the short data.
- d. Short CRC: It will be triggered when short CRC meet the condition.
Setup menu: short CRC
- Short CRC: Double-click on the “Short CRC” text field to pop up the numeric keyboard to set the short CRC. For details on the use of the numeric keyboard, refer to the section of [5.8 Parameter Setting](#). Select this parameter and use the Multipurpose rotary knob to change the short CRC.
- e. Short ID+ data: It will be triggered when short ID and short data meet the condition.
Setup menu: Short ID and short data. For the setting of each parameter, refer to trigger condition “State ID” and “Short data” above.
- f. Enhance ID: It will be triggered when enhance ID meet the condition.
Setup menu: enhance ID
Enhance ID: Double-click on the “Enhance ID” text field to pop up the numeric keyboard to set the enhance ID. For details on the use of the numeric keyboard, refer to the section of [5.8 Parameter Setting](#). Select this parameter and use the arrow key “”, ” below the Multipurpose rotary knob to move the selected cursor, then use the Multipurpose rotary knob to change enhance ID.
- g. Enhance data: It will be triggered when enhance data meet the condition.
Setup menu: enhance data
- Enhance data: Double-click on the “Enhance data” text field to pop up the numeric keyboard to set the enhance data. For details on the use of the numeric keyboard, refer to the section of [5.8 Parameter Setting](#). Select this parameter and use the arrow key “”, ” below the Multipurpose rotary knob to move the selected cursor, then use the Multipurpose rotary knob to change enhance data.
- h. Enhance CRC: It will be triggered when enhance CRC meet the condition.
Setup menu: enhance CRC
- Enhance CRC: Double-click on the “Enhance CRC” text field to pop up the numeric keyboard to set the enhance CRC. For details on the use of the numeric keyboard, refer to the section of [5.8 Parameter Setting](#). Select this parameter and use the arrow key

“←”, “→” below the Multipurpose rotary knob to move the selected cursor, then use the Multipurpose rotary knob to change enhance CRC.

- i. Enhance ID+ data: It will be triggered when enhance ID and enhance CRC meet the condition.

Setup menu: enhance ID and enhance CRC. For the setting of each parameter, refer to trigger condition “Enhance ID” and “Enhance data” above.

- j. Slow channel CRC error: Triggered on slow channel CRC error.

8.25. ARINC429 Trigger

- (1) Trigger type

Press the Menu softkey on the front panel or tap the “T” trigger label on the top to enter the “Trigger” menu. Tap on the “Trigger type” to select “ARINC429”.

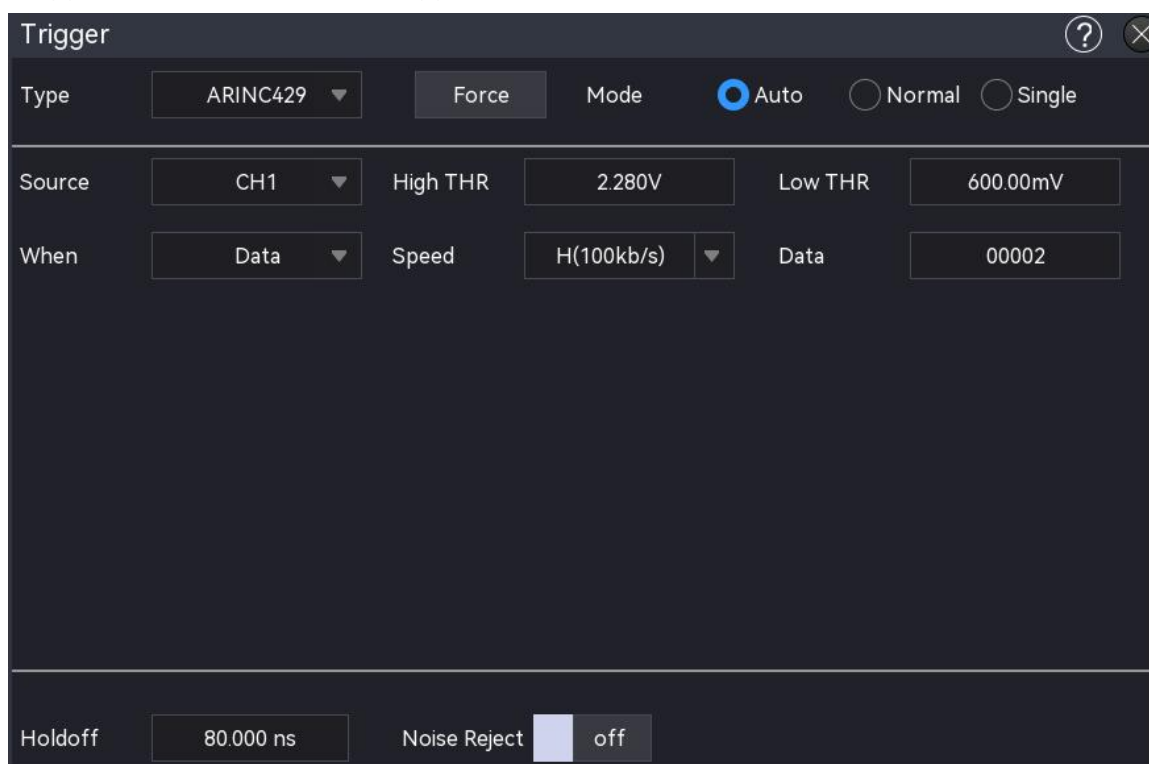

- (2) Source

Click on the “Source” to select CH1~CH4 or D0~D15, and refer to the section of [Trigger Source](#) for more details. The current source is displayed in the trigger label on the top of the screen. The source can only be triggered stably when the selected channel has a connected signal and to be the trigger source.

- (3) High/Low Level

Double-click on “High Level (Low Level)” text field to pop up the numeric keyboard to set the threshold; or rotate the Multipurpose rotary knob to adjust the threshold; or press the trigger

Position rotary knob to switch the threshold and rotate the rotary knob (the selected threshold is displayed in full line) to change the threshold.



(4) Speed

Click on the “Speed” to set the transmission rate to high (100kb/s), low (12.5kb/s) or custom.

(5) Trigger type

- a. Start bit: Triggered on the start bit of frame.
- b. End bit: Triggered on the end bit of frame.
- c. Label: Triggered on when the specified label occurs.

Setup menu: label

- Label: Double-click on the “Label” text field to pop up the numeric keyboard to set the label. For details on the use of the numeric keyboard, refer to the section of [5.8 Parameter Setting](#). Use the arrow key ,  below the Multipurpose rotary knob to move the selected cursor and then use the Multipurpose rotary knob to change the label. The range can be set to 00~FF.



- d. SDI: Triggered on when the specified SDI occurs.

Setup menu: SDI

- SDI: Double-click on the “SDI” text field to pop up the numeric keyboard to set the label. For details on the use of the numeric keyboard, refer to the section of [5.8 Parameter Setting](#). Select this parameter and use the Multipurpose rotary knob to change the SDI. The range can be set to 0~3.

- e. Data: The waveform will be triggered when data acquired by ARINC429 protocol. The user can quickly find the transmission signal that the specific data they are interested in.

Setup menu: data

- Data: Double-click on the “Data” text field to pop up the numeric keyboard to set the data. For details on the use of the numeric keyboard, refer to the section of [5.8 Parameter Setting](#). Select this parameter and use the arrow key ,  below the Multipurpose rotary knob to move the selected cursor, then use the Multipurpose rotary knob to set the data. The data range can be set to 00000~7FFFF.

- f. SSM: The waveform will be triggered when symbol state matrix is the same as the custom symbol state matrix.

Setup menu: SSM

- SSM: Double-click on “SSM” text field to pop up the numeric keyboard to set the SSM. For details on the use of the numeric keyboard, refer to the section of [5.8 Parameter Setting](#). Select this parameter and use the Multipurpose rotary knob to change the SSM.

The range can be set to 0~3

- g. Label + bit: It will be generated when the specified label and other fields.
Setup menu: label, data, SSM and SDI. For the setting of each parameter, refer to trigger condition "Address", "SDI", "Data" and "SSM" above.
- h. Parity check error: It will be generated when parity check error occurs.
- i. Bit error: It will be generated when bit error occurs.
- j. Interval error: It will be generated when interval error.
- k. All error: It will be generated when one of the above errors occurs.

8.26. Region Trigger

For complicated and volatile circuit signal in circuit debugging, the oscilloscope with high waveform capture rate can easily observe fleeting accidental abnormal signal. If user want to separate the abnormal signal from complicated and volatile circuit and to stable triggered. It may take a lot of time to learn the use of some advanced trigger, and even so, some more powerful advanced trigger also cannot be fully triggered.

MSO2000X/3000X series add the screen touch regional trigger function, it's really helpful for user to get the using of advanced trigger. Regional trigger function is very easy to use. User only need to open rectangle drawing function to draw one or two rectangle areas in the corresponding signal, it can quickly separate it and for observing signal. Regional trigger can be combined with basic trigger, advanced trigger and protocol trigger function, and it also supports decoding, waveform recording and pass/fail test. It's really handy for debugging complicated signals.

Regional trigger provides tow rectangle areas: Region A and Region B. Both regions support setting the region trigger condition to intersection or non-intersection; and the two regions support setting the corresponding enable sources CH1, CH2, CH3, CH4.

- (1) "Rectangle drawing" setting menu: Region A, source A, Region A, Region B, source B, Region B.
 - a. Region A: switch Region A ON/OFF
If there is a region box on the screen, ON: display the region box, OFF: close the region box.
 - b. Source A: set the source of Region A, it can set to CH1-CH4.
 - c. Region A: set whether Region A is intersect with Source A.
 - d. Region B: switch Region B ON/OFF
If there is a region box on the screen, ON: display the region box, OFF: close the region box.
 - e. Source B: set the source of Region B, it can set to CH1-CH4.
 - f. Region B: set whether Region B is intersect with Source B.

- (2) Region box setting menu: Cancel, 1: intersection, 1:non-intersection, 2: intersection,

2:non-intersection.

- a. Cancel: Close the currently drawn region and cancel the condition setting.
 - b. A: intersection: The currently drawn region as Region A, condition: Region A will trigger if it intersects with the waveform, and will not trigger if it does not intersect the waveform.
 - c. A: non-intersection: The currently drawn region as Region A, condition: Region A will trigger if it does not intersect the waveform, and will not trigger if it does intersect the waveform.
 - d. B: intersection: The currently drawn region as Region B, condition: Region B will trigger if it intersects with the waveform, and will not trigger if it does not intersect the waveform.
 - e. B: non-intersection: The currently drawn region as Region B, condition: Region B will trigger if it does not intersect the waveform, and will not trigger if it does intersect the waveform.
- The point is displayed in the intersection area. The diagonal line is displayed in the non-intersecting area. The setting menu can be displayed by clicking the region trigger box on the screen. Or you can touch the horizontal position and vertical position of the region trigger box in the moving area. When adjusting the time base scale and volts/div of the waveform, the region trigger box will expand and compress accordingly.

Open the region trigger on the abnormal signal, as shown in the following figure.

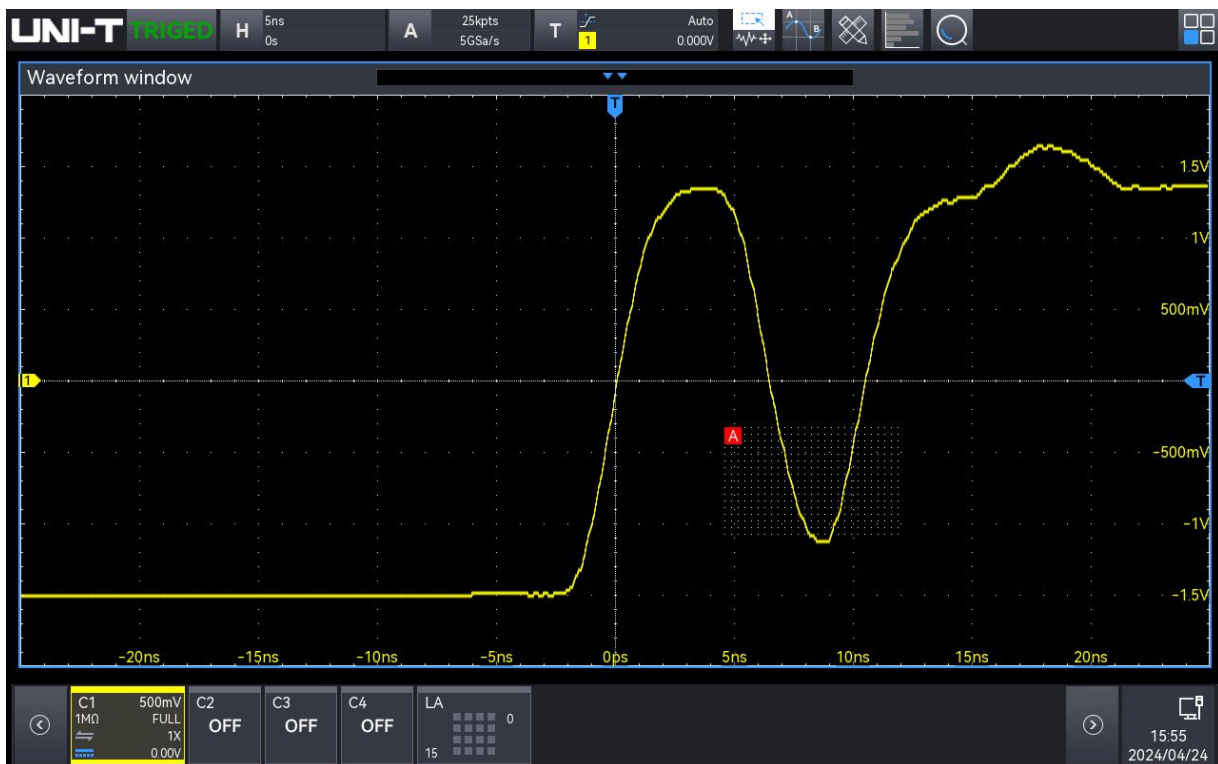

Note: If the currently selected region is already exists, then the current region trigger information will replace the original region trigger message and the region trigger box will be closed. When the instrument is reboot up, the region trigger setting will not be saved.





9. Protocol Decoding

- [RS232 Decoding](#)
- [I²C Decoding](#)
- [SPI Decoding](#)
- [CAN Decoding](#)
- [CAN-FD Decoding](#)
- [LIN Decoding](#)
- [FlexRay Decoding](#)
- [I2S Decoding](#)
- [1553B Decoding](#)
- [Manchester Decoding](#)
- [SNET Decoding](#)
- [ARINC429 Decoding](#)

Users can easily find errors, debug hardware and accelerate the development progress through the protocol decoding, to provide a guarantee of high speed and high quality to complete the project. MSO2000X/3000X provides four bus decoder modules (Decoder 1, Decoder 2, Decoder 3, and Decoder 4) to decode common protocols for analogue channel input signals. MSO2000X/3000X has protocol decoding of RS232, I²C, SPI, CAN, CAN-FD, LIN, FlexRay, I2S, 1553B, Manchester, SNET and ARINC429.

As Decode 1, Decode 2, Decode 3 and Decode 4 have the same decoding function and setting method, this chapter uses Decode 1 as an example.

Access the decoding setting menu by the following steps.

- Press the trigger key  on the front panel to enter the decoding setting menu.
- Click the Home icon  on the top right corner of the screen, click the decoding icon  to enter the decoding setting menu.
- If the decoding function is added in the toolbar, click the decoding icon  on the top right corner of the screen to enter the decoding setting menu.

9.1. RS232 Decoding

RS232 is asynchronous transmission standard interface established by Electronic Industries Association. It usually includes two application formats DB-9 or DB-25. It is suitable for the communication that the data transmission rate within the range 0~29491200/s.

It is widely used in microcomputer interface, the data to be transmitted is combined into a specified set of serial bits according to the protocol rules and sent it in an asynchronous serial way.

The data to be transmitted for each time, composing by the following rules.

Send one start bit at first, and send 5~8 data bits, and send optional parity check bit, and send one or two stop bits at last. The number of data bits is agreed by both communicating parties, it can be 5~8 bits, no parity check bit or odd parity check bit or even parity check bit. The stop bit can be set to one bit or two bit. In the following description, a transmission of a data string is referred to as a frame.

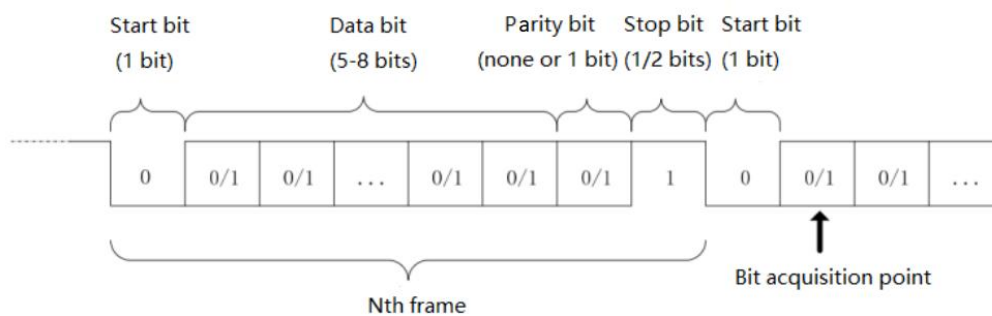

(1) Decoding parameter setting

a. Protocol type

Click on the "Protocol type" to select "UART/RS232".

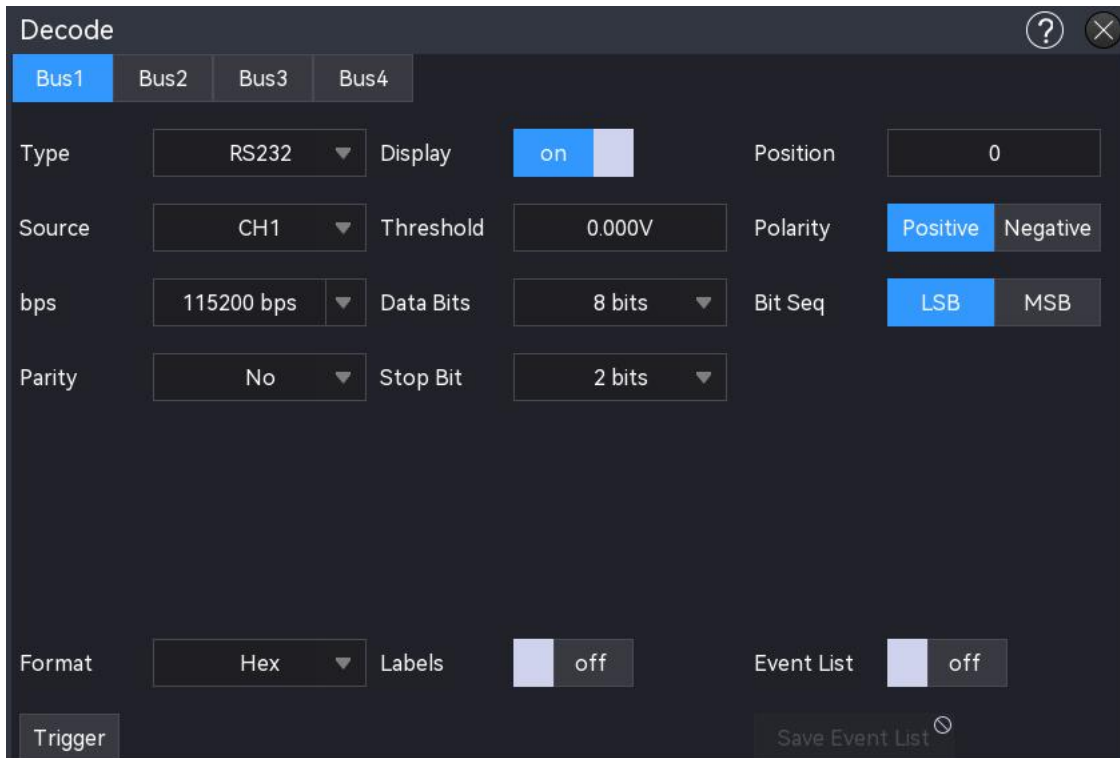

b. Source

Click on the “Source” to select CH1~CH4 or D0~D15. The current source is displayed on the top right corner of the screen. When the digital channel is opened in digital, the source can be displayed and D0~D15 can be selected.

Note: The source can only be triggered stably and decoded correctly when the selected channel has a connected signal and to be the trigger source.

c. Threshold

Set the threshold of source, tap to select the “Threshold” text field, rotate the Multipurpose rotary knob to adjust the threshold; or double-click on the “Threshold” text field to pop up the numeric keyboard to set the threshold. The threshold range is related to the vertical scale and vertical offset of the source.

When the threshold is changed, a dotted line appears on the screen indicating the current threshold. If the change is stopped, the dotted line of the threshold disappears after about 2 seconds.

d. Polarity

Click on the “Polarity” to select positive or negative.

- Negative: The reversed polarity of logic level, i.e. the high level is 0 and the low level is 1.
- Positive: The normal polarity of logic level, i.e. the high level is 1 and the low level is 0.

e. Parity check

Set the parity check of data transmission. Click on the "Parity check" to select to none, even parity check or odd parity check.

f. Data bit

Set the data bit width for the specified decoding RS232 protocol signal, click on the "Data bit" to select to 5 bits, 6 bits, 7 bits or 8 bits.

g. Bit sequence

Set the data bit sequence for RS232 protocol signal, click on the "Bit sequence" to select to MSB or LSB.

- MSB: the most significant bit, i.e. the most significant bit transmitted first in a sequence

- LSB: the least significant bit, i.e. the least significant bit transmitted first in a sequence

h. Stop bit

Set the stop bit for each data, click on the "Stop bit" to select to 1 bit or 2 bits.

i. Bitrate

When RS232 communication is asynchronous transmission communication, no accompanying clock signal during the data transmission process, in order to solve the determination of data bits, the protocol requires that the two sides of communication to agree on the bit rate. Generally, the bit rate is defined as the number of bits that can be transmitted for 1 s time, for example, 9600 bps means that 9600 bits can be transmitted for 1 s. The bitrate is not directly equal to the effective data transmission rate. Note that the start bit, data bit, checksum and stop bit are all counted as bit bits, so the bitrate is not directly equal to the effective data rate. The oscilloscope will set the bitrate according to the bitrate form bit sampling.

Bitrate can be set to 2400 bps, 4800 bps, 9600 bps, 19200 bps, 38400 bps, 57600 bps, 115200 bps or custom. Pop up the numeric keyboard to set the custom bitrate.

It is recommended to make reasonable settings according to your RS232 communication hardware and software. Due to the basic model of this transmission protocol, RS232 protocol is usually used in short distance (less than 20 m), low speed (less than 1 Mbps) transmission occasions, and the communication outside of this range is susceptible to interference and becomes unreliable.

(2) Decoding bus setting

a. Bus switch

Click on the "Bus switch" to switch on/off the bus function.

b. Decoding line

Set the display position of decoding bus on the screen. The display position of decoding line can be adjusted by using Multipurpose rotary knob; or double-click on the "Decoding

line” text field to pop up the numeric keyboard to set the position. The range can be set to 0~560.

c. Format

Set the display format for the decoding bus and event list decoding, click on the “Format” to select hexadecimal, decimalism, binary or ASCII.

d. Label

Click on the “Label” to switch on/off the decoding bus label. When the decoding bus label is switched on, it will display on the left top and display the current protocol type. When the decoding bus label is switched off, it will not be displayed.

(3) Event list

Click on the “Event list” to switch on/off the event list. When the event list is switched on, it will be displayed as shown in the following figure. Click the event list icon on the right top to close it.



(4) Save event list

When the operating state is RUN/STOP, the time and decoding data in the current event list can be exported.

Click the “Save event list” key in the decoding menu to pop up the export setting menu, the data can be saved in *.csv , *.html and *.pdf to internal storage or external USB (when a USB is detected). For the setting steps, refer to the section of [Storage and Load](#).

Note: When the operating state is RUN, the decoding data may be unstable, the user can manually stop the oscilloscope to export a stable decoding signal.

(5) Trigger menu

Click on the “Trigger” to directly access the trigger menu and the trigger mode is the same as the decoding type.

9.2. I²C Decoding

I²C trigger is usually used to connect microcontrollers and peripheral devices, it's widely used in microelectronics area. This bus protocol has two lines to transmit, one line is serial data SDA, and another line is serial clock SCL. Use master-slave system to communicate, which can two-way communication for master and slave computer.

This bus is the bus of multiple masters, preventing data corruption through conflict demodulation and arbitration mechanisms. It is worth note that the I²C bus have two address bit width, 7 bits and 10 bits, 10 bits and 7 bits address are compatible and can be used in combination. SCL and SDA on the I²C bus can both be connected to the positive supply via a pull-up resistor. When the bus is idle, both lines are high level. When any device on the bus outputs the low level, it causes the bus signal to become low, i.e. a logical "AND" between the signals of multiple devices. This special logical relationship is the key to realizing bus arbitration. The protocol requires the data signal SDA to remain stable while the clock signal SCL is high, and data is usually transmitted in MSB form, as shown in the following figure.

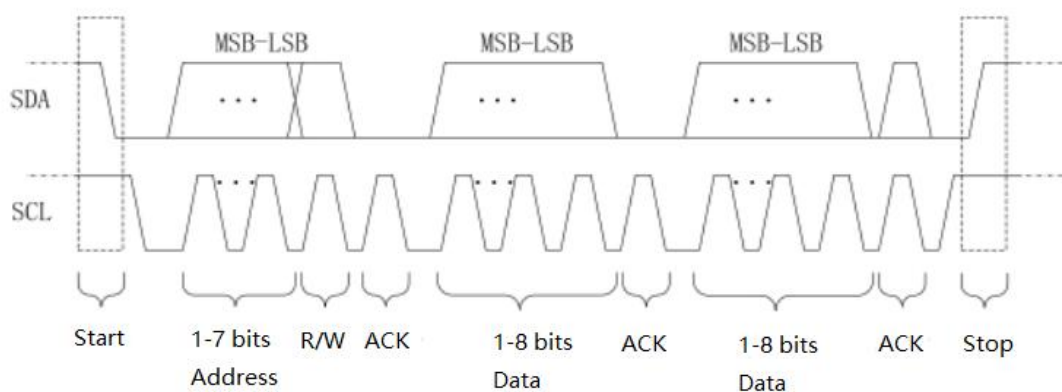

(1) Decoding parameter setting

a. Protocol type

Click on the “Protocol type” to select “I²C”.

b. Source

Set the clock source and data source. The source can only be triggered stably when the selected channel has a connected signal and to be the trigger source.

- Clock source

Click on the “Clock Source” to select CH1~CH4, D0~D15, and refer to the section of

[Trigger Source](#) for more details. The current source is displayed in the trigger label on the top of the screen.

■ Data source

Click on the “Data Source” to select CH1-CH4, D0-D15, and refer to the section of [Trigger Source](#) for more details. The current source is displayed in the trigger label on the top of the screen.

c. Threshold

Click to select “SCL threshold, SDA threshold”, and double-click on the “Threshold” text field to pop up the numeric keyboard to set the threshold; or rotate the [Multipurpose](#) rotary knob to adjust the threshold.

d. Address length

Set the address bit width of I²C signal, click on the “Address Length” to select 7 bits or 10 bits.

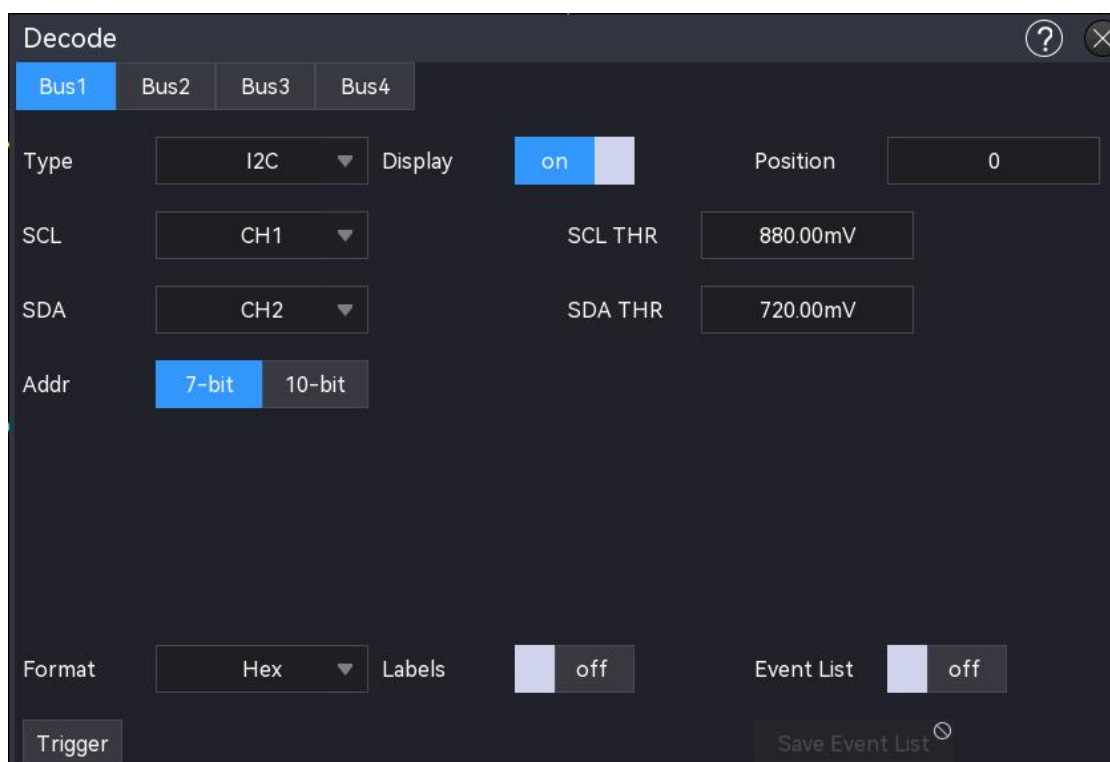

(2) Decoding bus setting

a. Bus switch

Click on the “Bus switch” to switch on/off the bus function.

b. Decoding line

Set the display position of decoding bus on the screen. The display position of decoding line can be adjusted by using [Multipurpose](#) rotary knob; or double-click on the “Decoding line” text field to pop up the numeric keyboard to set the position. The range can be set to 0~560

c. Format

Set the display format for the decoding bus and event list decoding, click on the “Format” to select hexadecimal, decimalism or binary.

d. Label

Click on the “Label” to switch on/off the decoding bus label. When the decoding bus label is switched on, it will display on the left top and display current protocol type. When the decoding bus label is switched off, it will not be displayed.

(3) Event list

Click on the “Event list” to switch on/off the event list. When the event list is switched on, it will be displayed as shown in the following figure. Click the event list icon on the right top to close it.



(4) Save event list

When the operating state is RUN/STOP, the time and decoding data in the current event list can be exported.

Click the “Save event list” key in the decoding menu to pop up the export setting menu, the data can be saved in *.csv , *.html and *.pdf to internal storage or external USB (when a USB is detected). For the setting steps, refer to the section of [Storage and Load](#).

Note: When the operating state is RUN, the decoding data may be unstable, the user can manually stop the oscilloscope to export a stable decoding signal.

(5) Trigger menu

Click on the “Trigger” to directly access the trigger menu and the trigger mode is the same as the decoding type.

9.3. SPI Decoding

SPI (Serial Peripheral Interface) allows the host to communicate with peripheral devices in a serial way. It's full-duplex and synchronous communication bus. It's usually use 4 signal connection line, MOSI: data output from master device, data input from slave device; MISO: data input from master device, data output from slave device; SCLK: clock signal is generated from master device; CS: chip select enable signal from slave device.

The SPI interface is mainly used for synchronous serial data transfer between the host and low-speed peripherals. Data is transferred bit by bit under the shift pulse of the master device, and the transfer format is MSB. SPI interface is widely used because it does not require slave address addressing, it is full duplex communication and the protocol is simple. The transmission of SPI protocol is shown in the following figure.

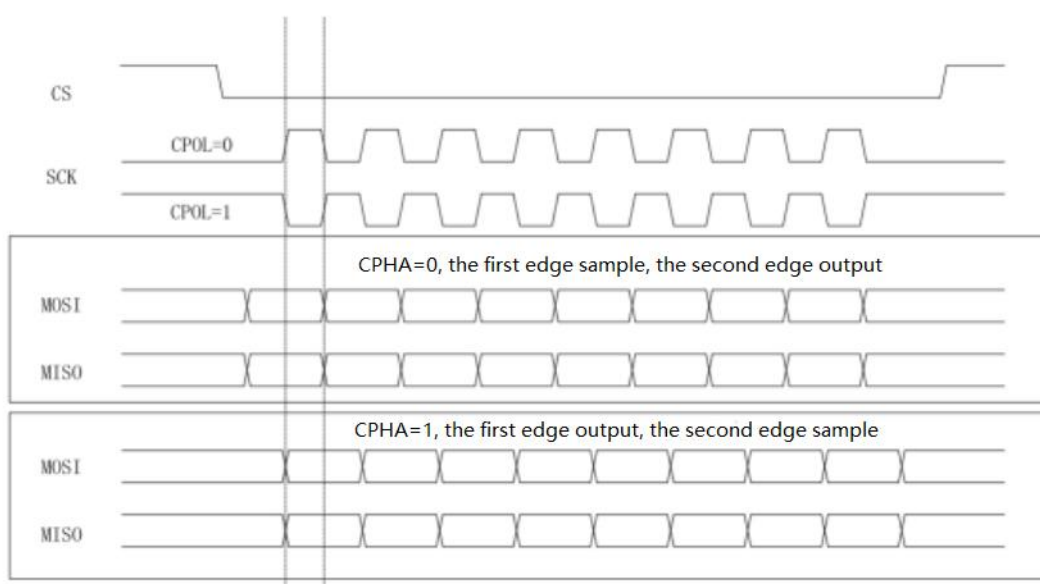

(1) Decoding parameter setting

a. Protocol type

Click on the “Protocol type” to select “SPI”.

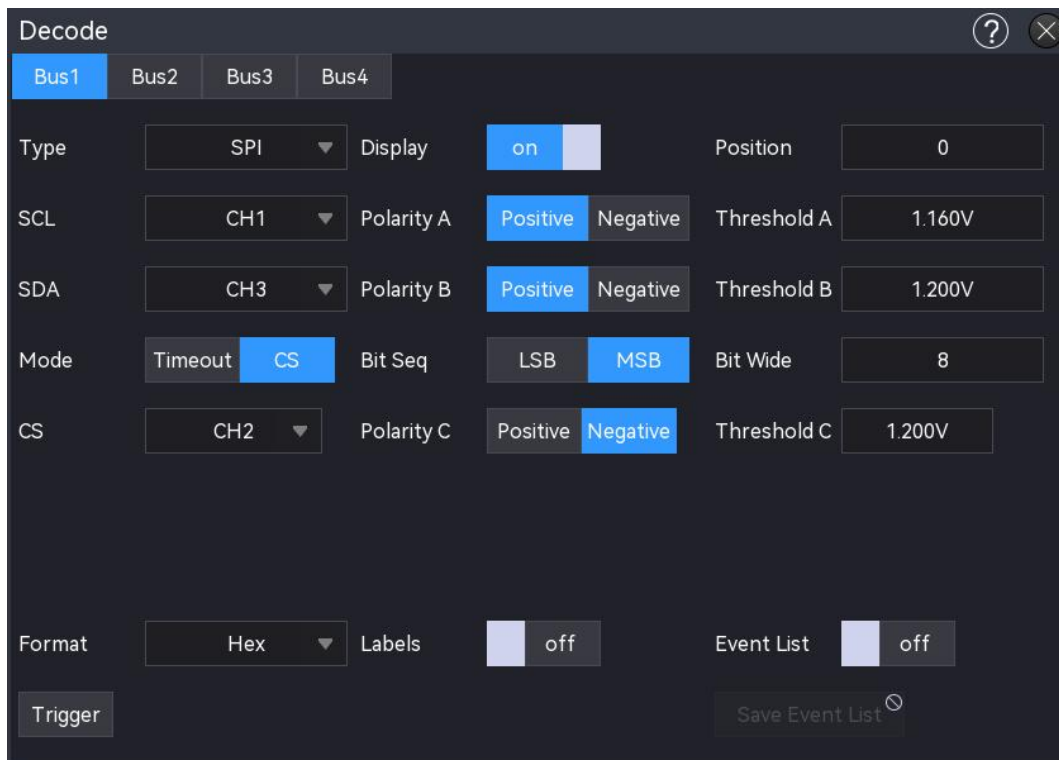

b. Source

Set the clock source, data source and CS source. The source can only be triggered stably when the selected channel has a connected signal and to be the trigger source.

- Clock source

Click on the “Clock Source” to select CH1~CH4, D0~D15, and refer to the section of [Trigger Source](#) for more details. The current source is displayed in the trigger label on the top of the screen.

- Data source

Click on the “Data Source” to select CH1~CH4, D0~D15, and refer to the section of [Trigger Source](#) for more details. The current source is displayed in the trigger label on the top of the screen.

- CS source

Click on the “CS Source” to select CH1~CH4, D0~D15, and refer to the section of [Trigger Source](#) for more details. The current source is displayed in the trigger label on the top of the screen.

c. Edge

- Clock polarity

Click on the “Clock Polarity” to select “Positive” or “Negative”.

Positive: Set to trigger on the positive of clock signal

Negative: Set to trigger on the negative of clock signal

- CS polarity

Click on the "CS Polarity" to select "Positive" or "Negative".

Positive: It is set to 1 if the signal is greater than the threshold, otherwise, it is 0.

Negative: It is set to 1 if 1 when the signal is less than the threshold, otherwise, it is 0.

■ Data polarity

Click on the "Data Polarity" to select "Positive" or "Negative".

Positive: It is set to 1 if the signal is greater than the threshold, otherwise, it is 0.

Negative: It is set to 1 if 1 when the signal is less than the threshold, otherwise, it is 0.

d. Threshold

Click on the "Threshold A, Threshold B, Threshold C", and double-click on "Threshold" text field to pop up the numeric keyboard to set the Threshold; or rotate the Multipurpose rotary knob to adjust the Threshold.

e. Mode

Click on the "Mode" to select SPI and timeout, CS can be set.

- Timeout: After the clock signal (CLK) remains idle for the specified time, the oscilloscope triggers when it searches for data that meets the trigger conditions (MISO).

- CS: When the CS is valid, the oscilloscope triggers when it searches for data that meets the trigger conditions (SDA).

j. Bit sequence



Set the bit sequence for RS232, click on the "Bit Sequence" to select MSB or LSB.

- MSB: the most significant bit, i.e. the most significant bit transmitted first in a sequence
- LSB: the least significant bit, i.e. the least significant bit transmitted first in a sequence

k. Bit width

Set the bit width for each data unit in the SPI protocol signal. Double click on the "Bit Width" text field to set the bit width. For details on the use of the numeric keyboard, refer to the section of [5.8 Parameter Setting](#). Select this parameter and use the Multipurpose rotary knob to change the bit width, it can be set to 4 ~ 32 bits.

l. Timeout

Double click on the "Timeout" text field to set the timeout. For details on the use of the numeric keyboard, refer to the section of [5.8 Parameter Setting](#); or select this parameter and use arrow keys ,  below the Multipurpose rotary knob to move the cursor, and then rotate the Multipurpose rotary knob to change the timeout, it can be set to 100 ns~1 s.

(2) Decoding bus setting

a. Bus switch

Click on the “Bus switch” to switch on/off the bus function.

b. Decoding line

Set the display position of decoding bus on the screen. The display position of decoding line can be adjusted by using Multipurpose rotary knob; or double-click on the “Decoding line” text field to pop up the numeric keyboard to set the position. The range can be set to 0~560.

c. Format

Set the display format for the decoding bus and event list decoding, click on the “Format” to select hexadecimal, decimalism or binary.

d. Label

Click on the “Label” to switch on/off the decoding bus label. When the decoding bus label is switched on, it will display on the left top and display current protocol type. When the decoding bus label is switched off, it will not be displayed.

(3) Event list

Click on the “Event list” to switch on/off the event list. When the event list is switched on, it will be displayed as shown in the following figure. Click the event list icon on the right top to close it.

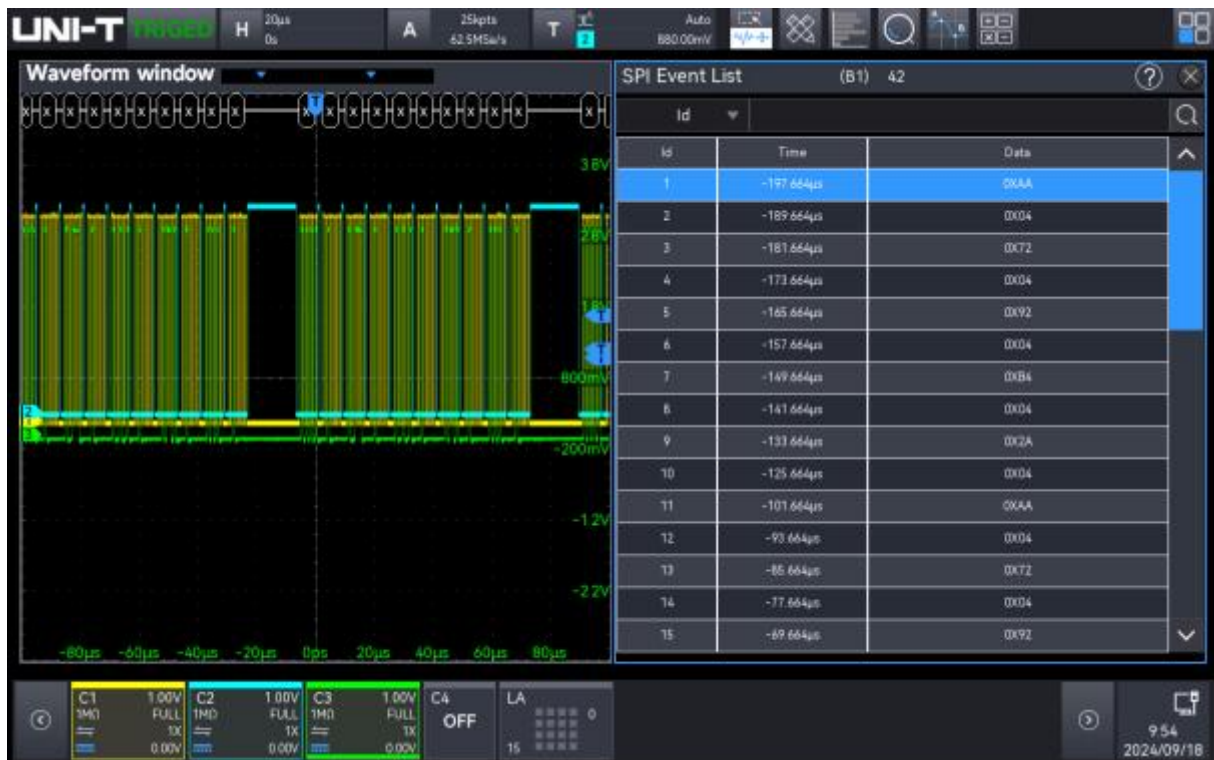

(4) Save event list

When the operating state is RUN/STOP, the time and decoding data in the current event list can

be exported.

Click the “Save event list” key in the decoding menu to pop up the export setting menu, the data can be saved in *.csv , *.html and *.pdf to internal storage or external USB (when a USB is detected). For the setting steps, refer to the section of [Storage and Load](#).

Note: When the operating state is RUN, the decoding data may be unstable, the user can manually stop the oscilloscope to export a stable decoding signal.

(5) Trigger menu

Click on the “Trigger” to directly access the trigger menu and the trigger mode is the same as the decoding type.

9.4. FlexRay Decoding

FlexRay is a differential serial bus configured with three consecutive segments (header, payload and tail). The oscilloscope samples the FlexRay signal at the specified sampling position and also determines whether each data point is a logic "1" or a logic "0" based on a set threshold level.

FlexRay decoding requires the signal type and rate to be specified.

(1) Decoding parameter setting

a. Protocol type

Click on the “Protocol type” to select “FlexRay”.

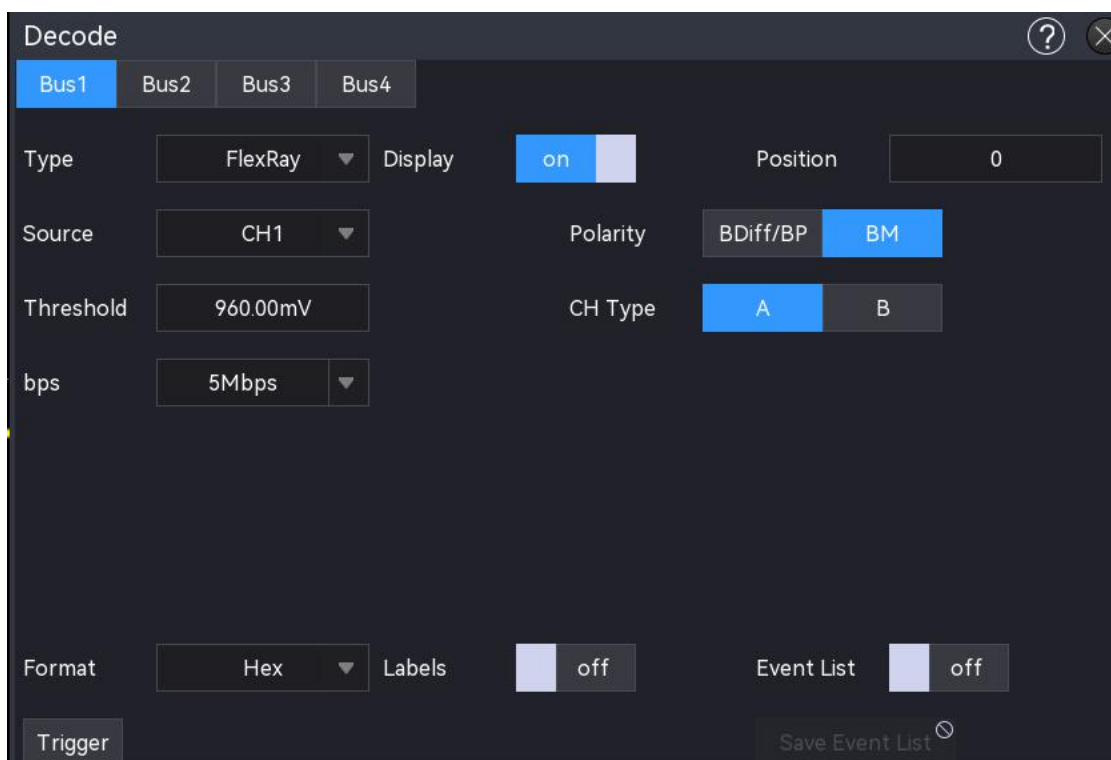

b. Source

Click on the “Source” to select CH1~CH4, D0~D15, and refer to the section of [Trigger](#)

[Source](#) for more details. The current source is displayed in the trigger label on the top of the screen.

The source can only be triggered stably when the selected channel has a connected signal and to be the trigger source.

c. Polarity

Click on the “Polarity” to select BDiff, BP or BM.

d. Threshold

Double-click on the “Threshold” text field to pop up the numeric keyboard to set the threshold; or rotate the [Multipurpose](#) rotary knob to adjust the threshold.

e. Channel type

Click on the “Channel Type” to select A or B.

f. Bitrate

Click on the “Bitrate” to select to 2.5 M, 5 M, 10 M, or custom.

If "Custom" is selected, a custom bitrate can be entered.

(2) Decoding bus setting

a. Bus switch

Click on the “Bus switch” to switch on/off the bus function.

b. Decoding line

Set the display position of decoding bus on the screen. The display position of decoding line can be adjusted by using [Multipurpose](#) rotary knob; or double-click on the “Decoding line” text field to pop up the numeric keyboard to set the position. The range can be set to 0~560.

c. Format

Set the display format for the decoding bus and event list decoding, click on the “Format” to select hexadecimal, decimalism or binary.

d. Label

Click on the “Label” to switch on/off the decoding bus label. When the decoding bus label is switched on, it will display on the left top and display the current protocol type. When the decoding bus label is switched off, it will not be displayed.

(3) Event list

Click on the “Event list” to switch on/off the event list. When the event list is switched on, it will be displayed as shown in the following figure. Click the event list icon on the right top to close it.



(4) Save event list

When the operating state is RUN/STOP, the time and decoding data in the current event list can be exported.

Click the “Save event list” key in the decoding menu to pop up the export setting menu, the data can be saved in *.csv , *.html and *.pdf to internal storage or external USB (when a USB is detected). For the setting steps, refer to the section of [Storage and Load](#).

Note: When the operating state is RUN, the decoding data may be unstable, the user can manually stop the oscilloscope to export a stable decoding signal.

(5) Trigger menu

Click on the “Trigger” to directly access the trigger menu and the trigger mode is the same as the decoding type.

9.5. CAN Decoding

(1) Decoding parameter setting

a. Protocol type

Click on the “Protocol type” to select “CAN”.

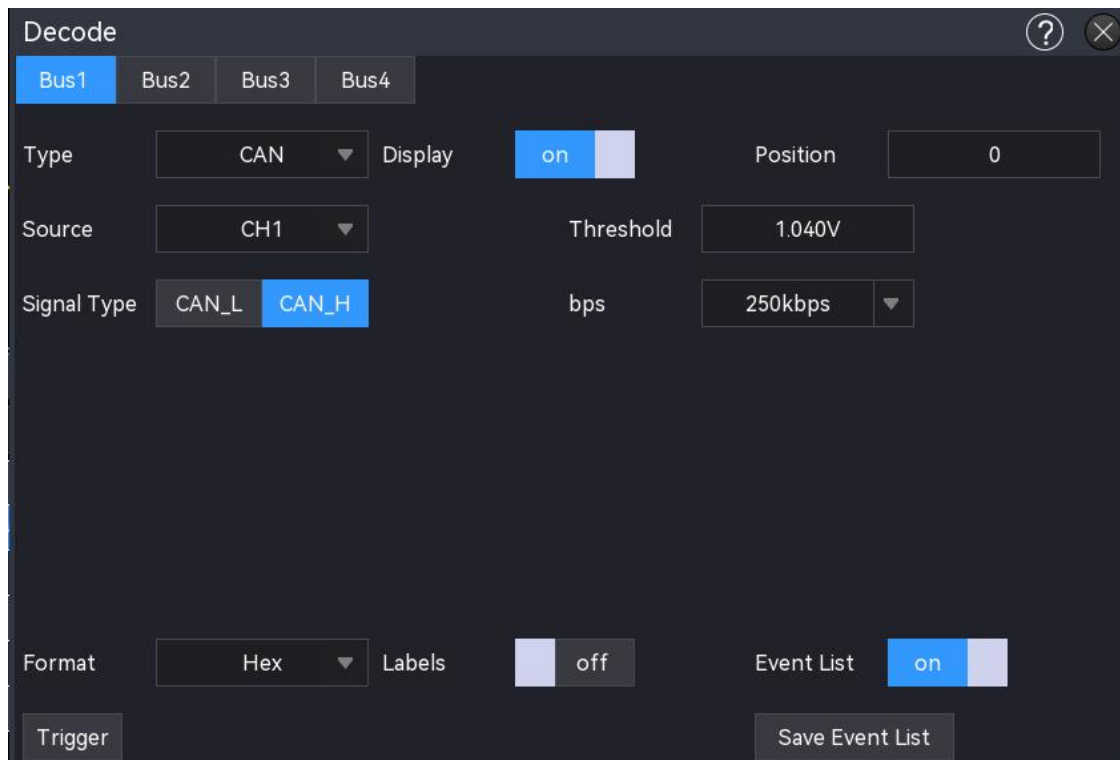

b. Source

Click on the “Source” to select CH1-CH4, D0~D15, and refer to the section of [Trigger Source](#) for more details. The current source is displayed in the trigger label on the top of the screen.

The source can only be triggered stably when the selected channel has a connected signal and to be the trigger source.

c. Threshold

Double-click on the “Threshold” text field to pop up the numeric keyboard to set the Threshold; or rotate the [Multipurpose](#) rotary knob to adjust the Threshold.

When the Threshold is changed, a dotted line appears on the screen indicating the current trigger level. Once the change is stopped, the dotted line of the Threshold disappears after about 2 seconds.

d. Signal type

Select whether the current signal accessed by the source is a high data line signal or a low data line signal. Click on the “Signal type” to select “CAN_H,” or “CAN_L”.

e. Bitrate

Select the bitrate for CAN serial bus data, click on the “Bitrate” to select to 10 kbps, 19.2 kbps, 20 kbps, 33.3 kbps, 38.4 kbps, 50 kbps, 57.6 kbps, 62.5 kbps, 83.3 kbps, 100 kbps, 115.2 kbps, 125 kbps, 230.4 kbps, 250 kbps, 490.8 kbps, 500 kbps, 800 kbps, 921.6 kbps, 1 Mbps, 2 Mbps, 3 Mbps, 4 Mbps, 5 Mbps or custom.

If "Custom" is selected, a custom bitrate can be entered.

(2) Decoding bus setting

e. Bus switch

Click on the "Bus switch" to switch on/off the bus function.

f. Decoding line

Set the display position of decoding bus on the screen. The display position of decoding line can be adjusted by using Multipurpose rotary knob; or double-click on the "Decoding line" text field to pop up the numeric keyboard to set the position. The range can be set to 0~560.

g. Format

Set the display format for the decoding bus and event list decoding, click on the "Format" to select hexadecimal, decimalism or binary.

h. Label

Click on the "Label" to switch on/off the decoding bus label. When the decoding bus label is switched on, it will display on the left top and display the current protocol type. When the decoding bus label is switched off, it will not be displayed.

(3) Event list

Click on the "Event list" to switch on/off the event list. When the event list is switched on, it will be displayed as shown in the following figure. Click the event list icon on the right top to close it.

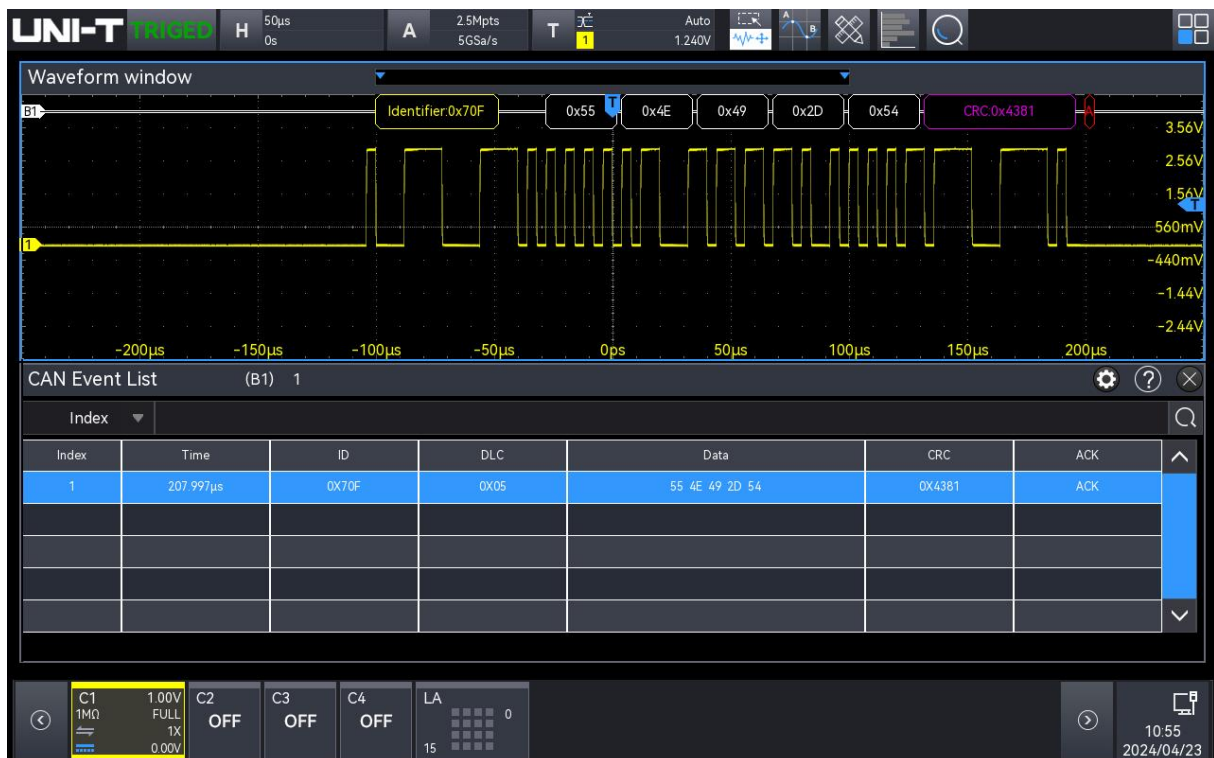

(4) Save event list

When the operating state is RUN/STOP, the time and decoding data in the current event list can be exported.

Click the “Save event list” key in the decoding menu to pop up the export setting menu, the data can be saved in *.csv , *.html and *.pdf to internal storage or external USB (when a USB is detected). For the setting steps, refer to the section of [Storage and Load](#).

Note: When the operating state is RUN, the decoding data may be unstable, the user can manually stop the oscilloscope to export a stable decoding signal.

(5) Trigger menu

Click on the “Trigger” to directly access the trigger menu and the trigger mode is the same as the decoding type.

9.6. CAN-FD Decoding

(1) Decoding parameter setting

a. Protocol type

Click on the “Protocol type” to select “CAN-FD”.

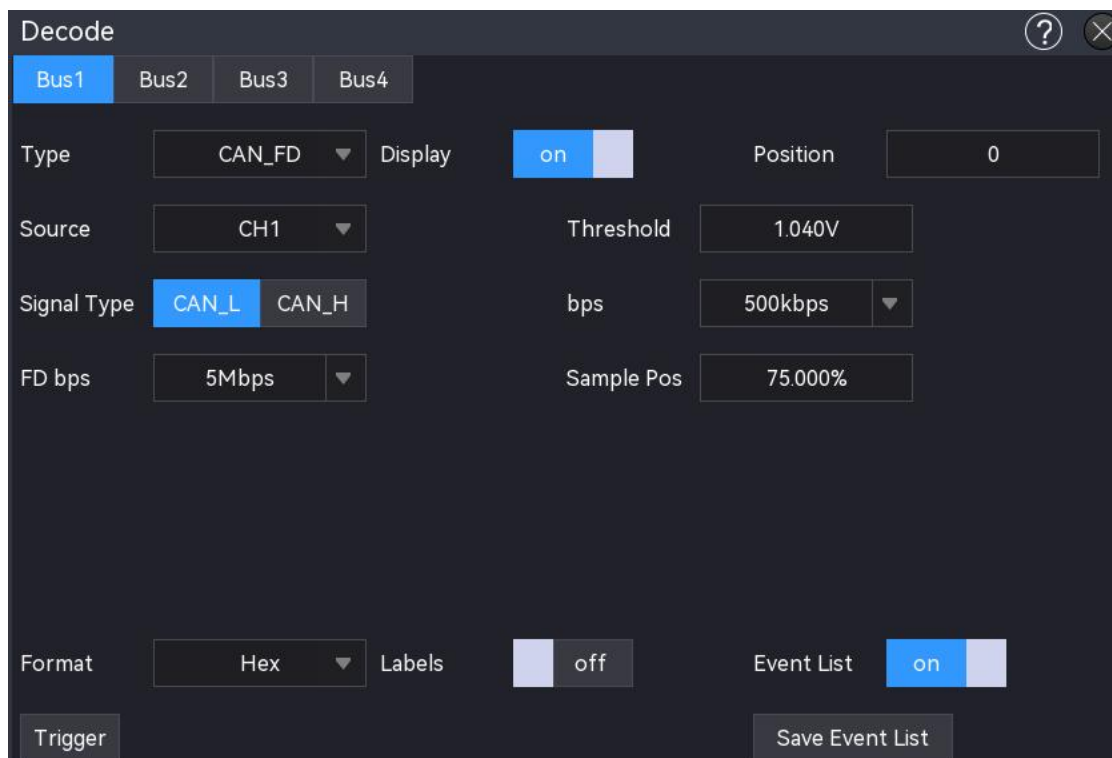

b. Source

Click on the “Source” to select CH1~CH4, D0~D15, and refer to the section of [Trigger Source](#) for more details. The current source is displayed in the trigger label on the top of the screen.

The source can only be triggered stably when the selected channel has a connected signal and to be the trigger source.

c. Threshold

Double-click on "Threshold" text field to pop up the numeric keyboard to set the threshold; or rotate the Multipurpose rotary knob to adjust the threshold.

When the threshold is changed, a dotted line appears on the screen indicating the current threshold. If the change is stopped, the dotted line of the threshold disappears after about 2 seconds.

d. Signal type

Select whether the current signal accessed by the source is a high data line signal or a low data line signal. Click on the "Signal type" to select "CAN_H" or "CAN_L".

e. Bitrate (bps)

Select the bitrate for CAN-FD serial bus data, click on the "Bitrate" to select to 10 kbps, 19.2 kbps, 20 kbps, 33.3 kbps, 38.4 kbps, 50 kbps, 57.6 kbps, 62.5 kbps, 83.3 kbps, 100 kbps, 115.2 kbps, 125 kbps, 230.4 kbps, 250 kbps, 490.8 kbps, 500 kbps, 800 kbps, 921.6 kbps, 1 Mbps, 2 Mbps, 3 Mbps, 4 Mbps, 5 Mbps or custom.

If "Custom" is selected, a custom bitrate can be entered.

f. FD bitrate

Select the FD bitrate for CAN-FD serial bus data, click on the "Bitrate" to select to 250 kbps, 500 kbps, 800 kbps, 1 Mbps, 1.5 Mbps, 2 Mbps, 4 Mbps, 6 Mbps, 8 Mbps or custom.

If "Custom" is selected, a custom bitrate can be entered.

g. Sampling position

The sample position is the point in the bit time where the oscilloscope samples the bit level. The sample position is expressed as a percentage of the "Time from bit start to sample point" and the "Bit time".

Click on the "Sampling position" text field to pop up the numeric keyboard to set the sampling position; or rotate the Multipurpose rotary knob to adjust the sampling position.

The range can be set to or press the trigger 30% ~ 90%.

(2) Decoding bus setting

a. Bus switch

Click on the "Bus switch" to switch on/off the bus function.

b. Decoding line

Set the display position of decoding bus on the screen. The display position of decoding line can be adjusted by using Multipurpose rotary knob; or double-click on the "Decoding line" text field to pop up the numeric keyboard to set the position. The range can be set to

0~560.

c. Format

Set the display format for the decoding bus and event list decoding, click on the “Format” to select hexadecimal, decimalism or binary.

d. Label

Click on the “Label” to switch on/off the decoding bus label. When the decoding bus label is switched on, it will display on the left top and display current protocol type. When the decoding bus label is switched off, it will not be displayed.

(3) Event list

Click on the “Event list” to switch on/off the event list. When the event list is switched on, it will be displayed as shown in the following figure. Click the event list icon on the right top to close it.



(4) Save event list

When the operating state is RUN/STOP, the time and decoding data in the current event list can be exported.

Click the “Save event list” key in the decoding menu to pop up the export setting menu, the data can be saved in *.csv , *.html and *.pdf to internal storage or external USB (when a USB is detected). For the setting steps, refer to the section of [Storage and Load](#).

Note: When the operating state is RUN, the decoding data may be unstable, the user can manually stop the oscilloscope to export a stable decoding signal.

(5) Trigger menu

Click on the “Trigger” to directly access the trigger menu and the trigger mode is the same as the decoding type.

9.7. LIN Decoding

(1) Decoding parameter setting

a. Protocol type

Click on the “Protocol type” to select “LIN”.

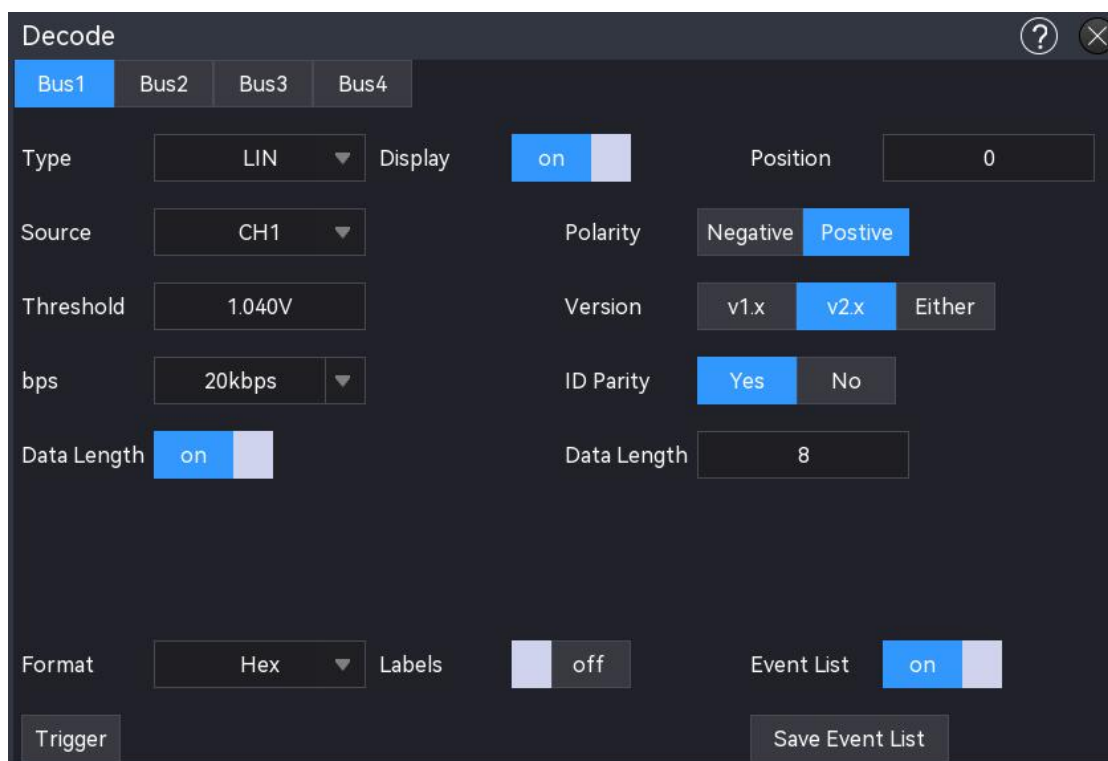

b. Source

Click on the “Source” to select CH1~CH4, D0~D15, and refer to the section of [Trigger Source](#) for more details. The current source is displayed in the trigger label on the top of the screen.

The source can only be triggered stably when the selected channel has a connected signal and to be the trigger source.

c. Polarity

Click on the “Polarity” to select the polarity to “Normal (high=1)” or “Reverse (high=0)”.

d. Threshold

Double-click on “Threshold” text field to pop up the numeric keyboard to set the threshold; or rotate the [Multipurpose](#) rotary knob to adjust the threshold.

When the threshold is changed, a dotted line appears on the screen indicating the current

threshold. If the change is stopped, the dotted line of the threshold disappears after about 2 seconds.

e. Version

Click on the "Version" to select the signal version to v1.x, v2.x or random.

f. Bitrate (bps)

Select the bitrate for LIN, click on the "Bitrate" to select to 1.2 k, 2.4 k, 4.8 k, 9.6 k, 10.417 k, 19.2 k, 20 k or custom.

If "Custom" is selected, a custom bitrate can be entered.

g. ID Parity check

Set ID Parity check to switch on/off.

ON: including parity bit and ID

OFF: not including parity bit and ID

h. Data length menu

Set whether to display the data length menu, click on the "Data Length" to switch on/off.

ON: Display the data length menu

OFF: Hide the data length menu

i. Data length

Set LIN data length, double-click on the "Data Length" text field to pop up the numeric keyboard to set the data length. For details on the use of the numeric keyboard, refer to the section of [5.8 Parameter Setting](#). Select this parameter and use the Multipurpose rotary knob to change the data length. The data length can be set to 1~8. It is only available when the data length menu is displayed.

(2) Decoding bus setting

a. Bus switch

Click on the "Bus switch" to switch on/off the bus function.

b. Decoding line

Set the display position of decoding bus on the screen. The display position of decoding line can be adjusted by using Multipurpose rotary knob; or double-click on the "Decoding line" text field to pop up the numeric keyboard to set the position. The range can be set to 0~560.

c. Format

Set the display format for the decoding bus and event list decoding, click on the "Format" to select hexadecimal, decimalism or binary.

d. Label

Click on the "Label" to switch on/off the decoding bus label. When the decoding bus label

is switched on, it will display on the left top and display current protocol type. When the decoding bus label is switched off, it will not be displayed.

(3) Event list

Click on the “Event list” to switch on/off the event list. When the event list is switched on, it will be displayed as shown in the following figure. Click the event list icon on the right top to close it.

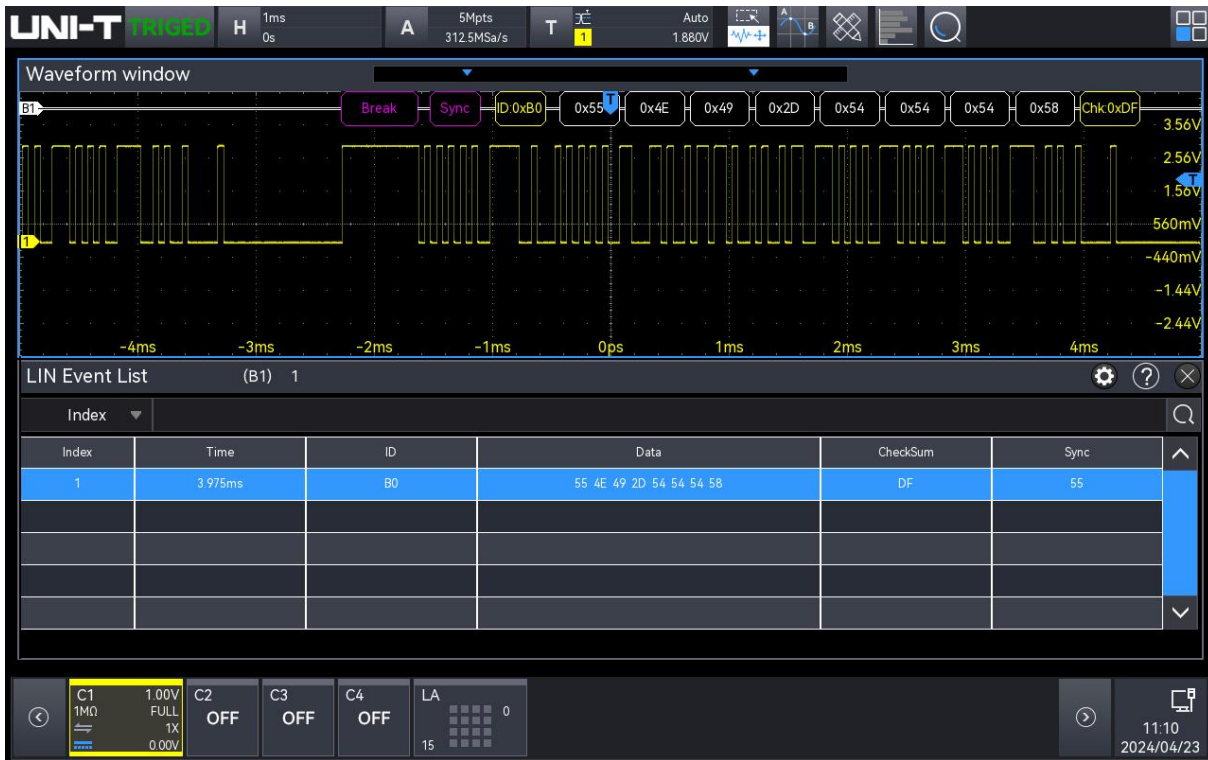

(4) Save event list

When the operating state is RUN/STOP, the time and decoding data in the current event list can be exported.

Click the “Save event list” key in the decoding menu to pop up the export setting menu, the data can be saved in *.csv , *.html and *.pdf to internal storage or external USB (when a USB is detected).

For the setting steps, refer to the section of [Storage and Load](#).

Note: When the operating state is RUN, the decoding data may be unstable, the user can manually stop the oscilloscope to export a stable decoding signal.

(5) Trigger menu

Click on the “Trigger” to directly access the trigger menu and the trigger mode is the same as the decoding type.

9.8. I2S Decoding

I2S (Inter-IC Sound) bus, also known as the Integrated Circuit Built-in Audio Bus, is a bus standard developed by Philips for the transmission of audio data between digital audio devices.

(1) Decoding parameter setting

a. Protocol type

Click on the "Protocol type" to select "I2S".

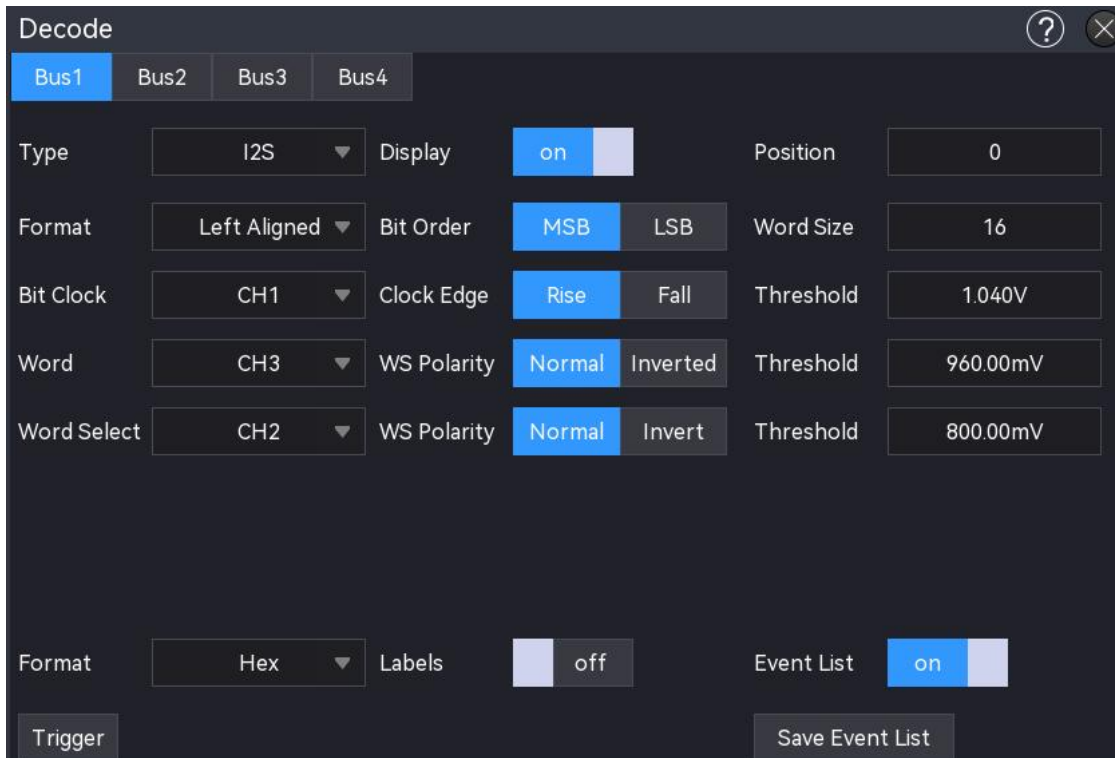

b. Format

Click on the "Format" to select standard, left justifying, right justifying and TDM.

- Standard: MSB of each sampled data is sent first and the LSB is sent last. MSB is displayed on the SDATA line, which at one clock bit clock after the edge of WS transition.

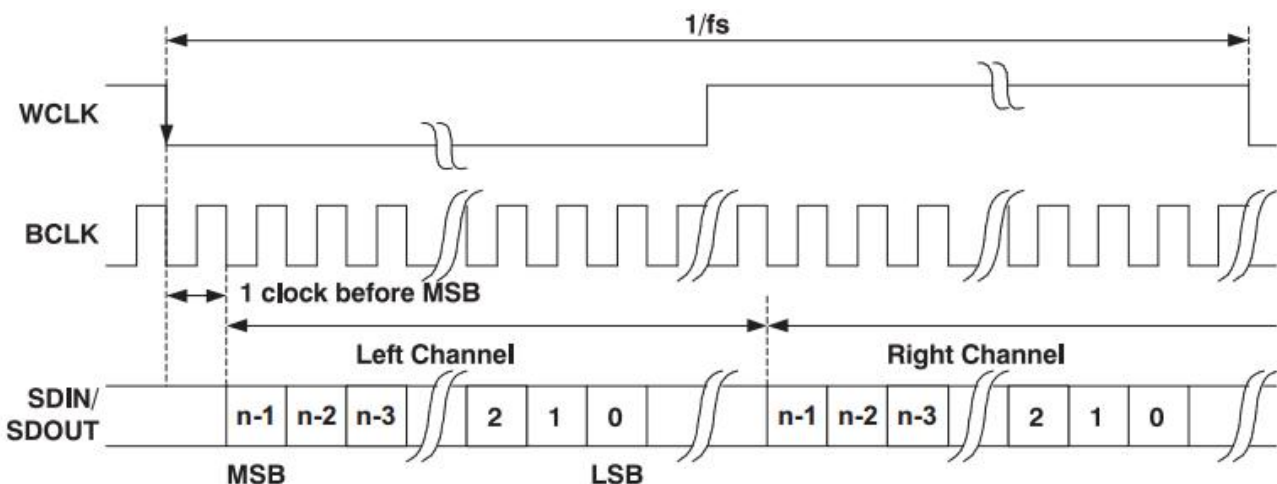

- Left justifying: Data transmission (MSB first) starts at the edge of the WS conversion (without the one bit delay used by the standard format).

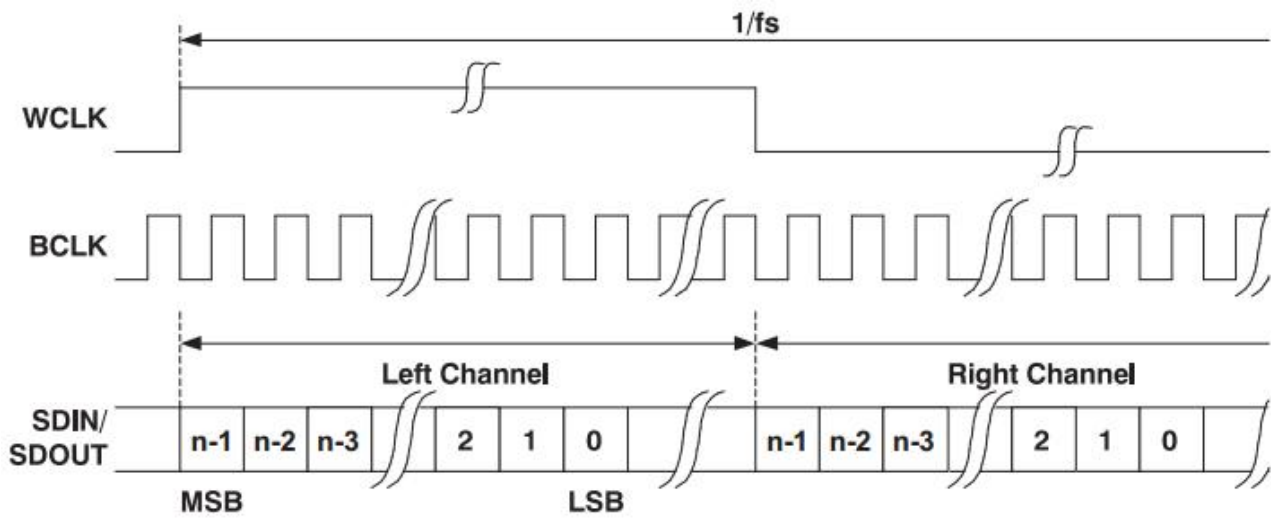

- Right justifying: Data transmission (MSB first) is right justifying with WS.

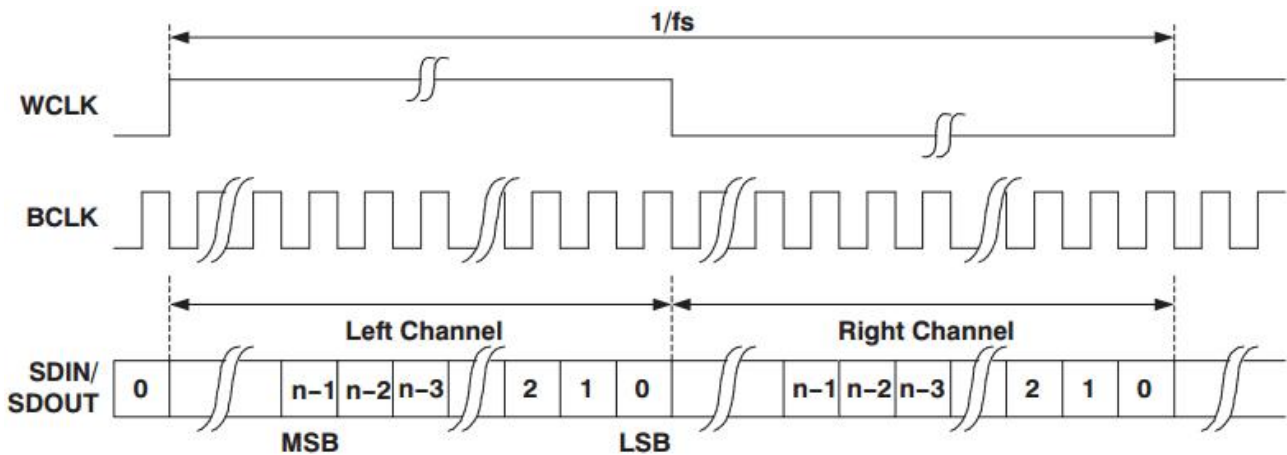

- TDM: (time division multiplexing) mode can transmit multi-channel data.

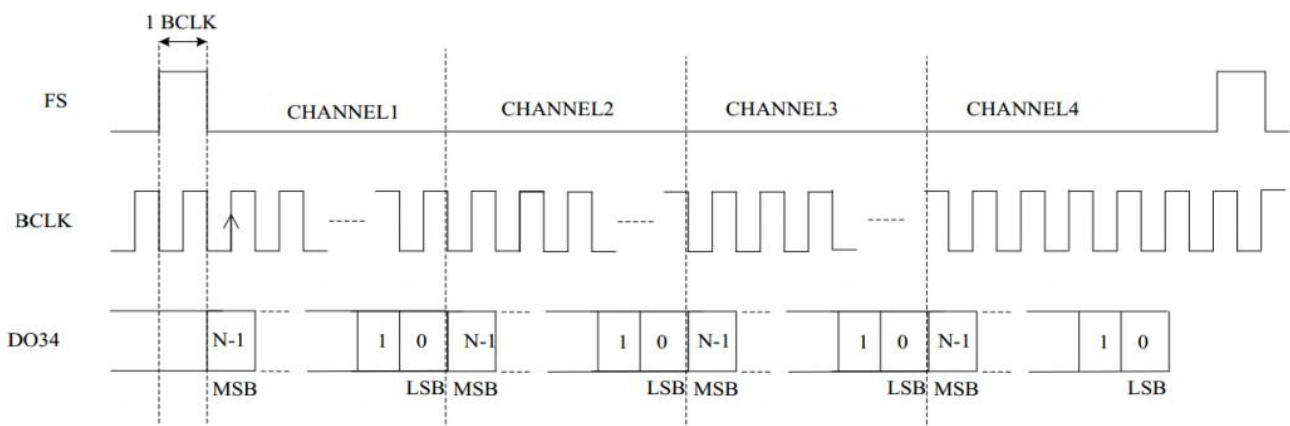

c. Bit Sequence

Click on the “Bit Sequence” to select “LSB” or “MSB”, the default is “MSB”.

d. Source

Set the bit clock, bit selection and data source. The source can only be triggered stably when the selected channel has a connected signal and to be the trigger source.

- Bit clock
Click on the “Bit Clock” to select CH1~CH4, D0~D15, and refer to the section of [Trigger Source](#) for more details. The current source is displayed in the trigger label on the top of the screen. The clock line (SCLK) provides the clock signal for synchronizing audio data transmission.
 - Bit selection
Click on the “Bit Clock” to select CH1~CH4, D0~D15, and refer to the section of [Trigger Source](#) for more details. The current source is displayed in the trigger label on the top of the screen. The bit selection indicates the audio data of the current transmission is left channel or right channel.
 - Data
Click on the “Data” to select CH1~CH4, D0~D15, and refer to the section of [Trigger Source](#) for more details. The current source is displayed in the trigger label on the top of the screen. The data line is used to transmit the actual audio data.
- e. Edge
- Clock edge
Click on the “Clock” to select “Rising/Falling” edge.
Rising edge: Sampling SDA on the rising edge of clock
Falling edge: Sampling SDA on the falling edge of clock
 - WS polarity
Click on the “WS Polarity” to select “Normal” or “Reverse”. The WS polarity determines the valid level for the bit selection signal. The bit selection signal indicates the frame start and end of frame for the audio data.
 - Data polarity
Click on the “Data Polarity” to select “high=1” or “high=0”.
- f. Threshold
Double-click on the “Threshold” text field to pop up the numeric keyboard to set the threshold; or rotate the [Multipurpose](#) rotary knob to adjust the threshold.
- g. Bit size
The bit size can be set when the format is standard, left justifying or right justifying. Double-click on the “Bit Size” text field to pop up the numeric keyboard to set the bit size. For details on the use of the numeric keyboard, refer to the section of [5.8 Parameter Setting](#). Select this parameter and use the [Multipurpose](#) rotary knob to change the bit size. The range of bit size can be set to 4~32.

(2) Decoding bus setting

a. Bus switch

Click on the “Bus switch” to switch on/off the bus function.

b. Decoding line

Set the display position of decoding bus on the screen. The display position of decoding line can be adjusted by using Multipurpose rotary knob; or double-click on the “Decoding line” text field to pop up the numeric keyboard to set the position. The range can be set to 0~560.

c. Format

Set the display format for the decoding bus and event list decoding, click on the “Format” to select hexadecimal, decimalism or binary.

d. Label

Click on the “Label” to switch on/off the decoding bus label. When the decoding bus label is switched on, it will display on the left top and display the current protocol type. When the decoding bus label is switched off, it will not be displayed.

(3) Event list

Click on the “Event list” to switch on/off the event list. When the event list is switched on, it will be displayed as shown in the following figure. Click the event list icon on the right top to close it.



(4) Save event list

When the operating state is RUN/STOP, the time and decoding data in the current event list can

be exported.

Click the “Save event list” key in the decoding menu to pop up the export setting menu, the data can be saved in *.csv , *.html and *.pdf to internal storage or external USB (when a USB is detected). For the setting steps, refer to the section of [Storage and Load](#).

Note: When the operating state is RUN, the decoding data may be unstable, the user can manually stop the oscilloscope to export a stable decoding signal.

(5) Trigger menu

Click on the “Trigger” to directly access the trigger menu and the trigger mode is the same as the decoding type.

9.9. 1553B Decoding

The oscilloscope samples the 1553B signal and also determines whether each data point is a logic "1" or "0" based on a set threshold. 1553B decoding requires the data channel source and threshold to be specified.

(1) Decoding parameter setting

a. Protocol type

Click on the “Protocol type” to select “1553B”.

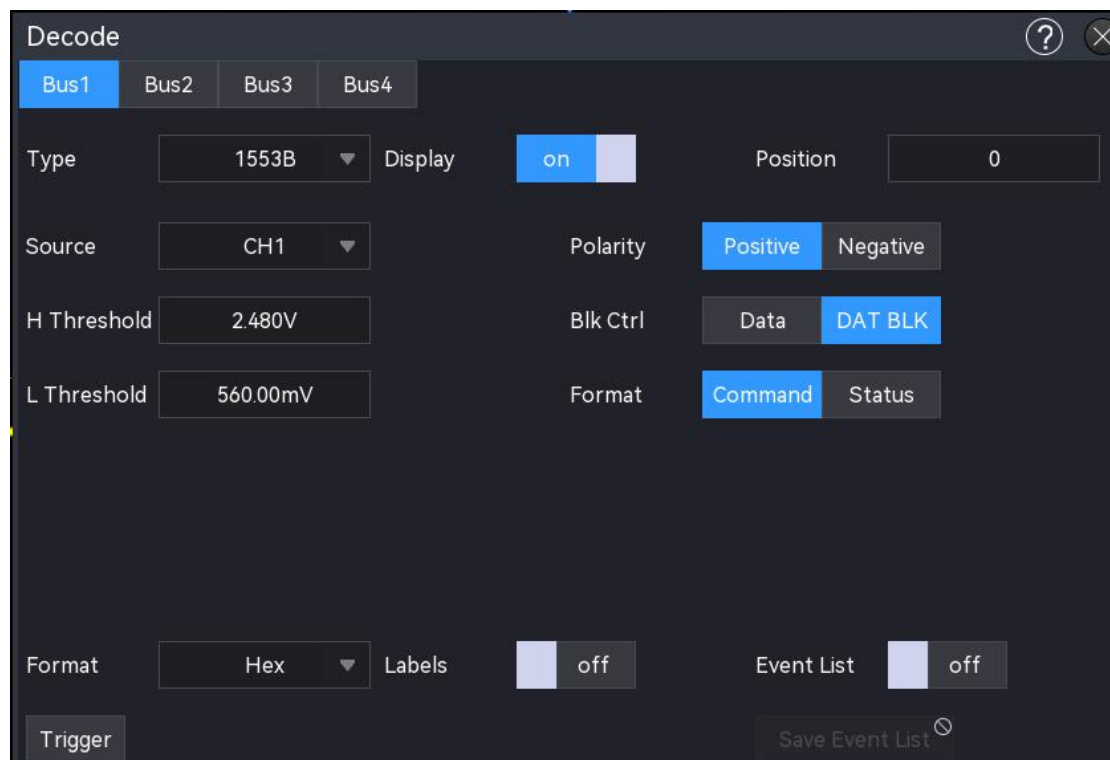

b. Source

Click on the “Source” to select CH1~CH4, and refer to the section of [Trigger Source](#) for more details. The current source is displayed in the trigger label on the top of the screen.

The source can only be triggered stably when the selected channel has a connected signal and to be the trigger source.

c. Polarity

Click on the “Polarity” to select “Positive” or “Negative”. The default is positive.

d. Threshold (High/Low)

Double-click on “Threshold (High/Low)” text field to pop up the numeric keyboard to set the threshold; or rotate the Multipurpose rotary knob to adjust the threshold. The threshold range is related to the vertical scale and vertical offset of the source.

e. Block control

Click on the “Block control” to select “Data” or “Data block” to decoding. The default is data.

f. Format

Click on the “Format” to set command word or state word.

If the format is the command word, the “state” trigger condition will be hidden.

If the format is the state word, the “command” trigger condition will be hidden.

(2) Decoding bus setting

a. Bus switch

Click on the “Bus switch” to switch on/off the bus function.

b. Decoding line

Set the display position of decoding bus on the screen. The display position of decoding line can be adjusted by using Multipurpose rotary knob; or double-click on the “Decoding line” text field to pop up the numeric keyboard to set the position. The range can be set to 0~560.。

c. Format

Set the display format for the decoding bus and event list decoding, click on the “Format” to select hexadecimal, decimalism or binary.

d. Label

Click on the “Label” to switch on/off the decoding bus label. When the decoding bus label is switched on, it will display on the left top and display the current protocol type. When the decoding bus label is switched off, it will not be displayed.

(3) Event list

Click on the “Event list” to switch on/off the event list. When the event list is switched on, it will be displayed as shown in the following figure. Click the event list icon on the right top to close it.



(4) Save event list

When the operating state is RUN/STOP, the time and decoding data in the current event list can be exported.

Click the “Save event list” key in the decoding menu to pop up the export setting menu, the data can be saved in *.csv , *.html and *.pdf to internal storage or external USB (when a USB is detected).

For the setting steps, refer to the section of [Storage and Load](#).

Note: When the operating state is RUN, the decoding data may be unstable, the user can manually stop the oscilloscope to export a stable decoding signal.

(5) Trigger menu

Click on the “Trigger” to directly access the trigger menu and the trigger mode is the same as the decoding type.

9.10. Manchester Decoding

Manchester encoding, also called phase encoding (PE), is a synchronous clock coding technique used by the physical layer to encode the clock and data of a synchronous bit stream. Manchester encoding is used in Ethernet medium systems.

Manchester encoding provides a simple way of encoding simple binary sequences without long cycles and without conversion levels, thus preventing loss of clock synchronization or analogue link bit errors due to low frequency shifts with poor compensation. In this technique, the actual binary

data transmitted through the cable is not sent as a sequence of logical 1's or 0's (technically known as Non Return to Zero (NRZ)). Instead, these bits are converted into a slightly different format, which has many advantages than the use of binary coding.

Manchester coding is commonly used in LAN transmission. Manchester coding is used to encode binary data '0' and '1' by level jumps.

(1) Decoding parameter setting

a. Protocol type

Click on the “Protocol type” to select “Manchester”.

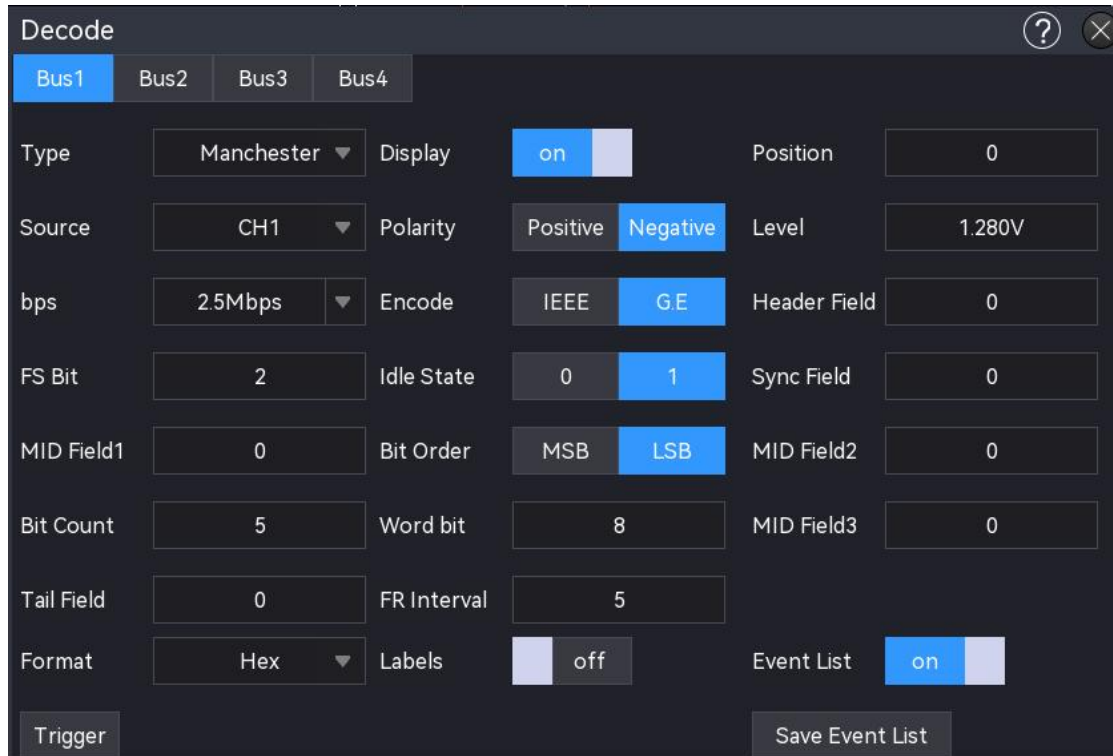

b. Source

Click on the “Source” to select CH1~CH4, D0~D15, and refer to the section of [Trigger Source](#) for more details. The current source is displayed in the trigger label on the top of the screen.

The source can only be triggered stably when the selected channel has a connected signal and to be the trigger source.

c. Polarity

Click on the “Polarity” to select positive or negative.

d. Threshold

Double-click on the “Threshold” text field to pop up the numeric keyboard to set the Threshold; or rotate the [Multipurpose](#) rotary knob to adjust the trigger level.

e. Encode mode

Click on the “Encode Mode” to switch to IEEE or G.E.

- IEEE: “1” indicates that a jump from low to high; “0” indicates that a jump from high to low.
- G.E: “1” indicates that a jump from low to high; “0” indicates that a jump from high to low.

f. Bitrate

Click on the “Bitrate” to select the baud rate of DUT to 1.2 kbps, 2.4 kbps, ps4.8 kbps, 9.6 kbps, 10.417 kbps, 19.2 kbps, 125 kbps, 250 kbps, 200 kbps, 1 Mbps, 2 Mbps, 5 Mbps, 10 Mbps or custom. The custom bitrate must match with the DUT, the default bitrate is 1.2 kbps.

g. Bit sequence

Click on the “Bit Sequence” to switch to MSB or LSB.

- MSB: the most significant bit, i.e. the most significant bit transmitted first in a sequence
- LSB: the least significant bit, i.e. the least significant bit transmitted first in a sequence

h. Idle state

Click on the “Idle State” to switch to 0 or 1.

- 0: The bus state is low level when no data is present.
- 1: The bus state is high level when no data is present.

i. Frame start bit

Click on the “Frame start bit” text field to pop up the numeric keyboard to enter the start bit. For details on the use of the numeric keyboard, refer to the section of [5.8 Parameter Setting](#). Select this parameter and use the Multipurpose rotary knob to change the start bit. The range can be set to 1~32.

j. Synchronization field

Click on the “Synchronization field” text field to pop up the numeric keyboard to enter the synchronization field. For details on the use of the numeric keyboard, refer to the section of [5.8 Parameter Setting](#). Select this parameter and use the Multipurpose rotary knob to change the synchronization field. The range can be set to 0~32.

k. Middle field 1

Click on the “Middle field 1” text field to pop up the numeric keyboard to enter the middle field 1. For details on the use of the numeric keyboard, refer to the section of [5.8 Parameter Setting](#). Select this parameter and use the Multipurpose rotary knob to change the middle field 1. The range can be set to 0~32.

l. Header field

Click on “Header field” text field to pop up the numeric keyboard to enter the header field.

For details on the use of the numeric keyboard, refer to the section of [5.8 Parameter Setting](#). Select this parameter and use the Multipurpose rotary knob to change the header field. The range can be set to 0~32.

m. Middle field 2

Click on the “Middle field 2” text field to pop up the numeric keyboard to enter the middle field 2. For details on the use of the numeric keyboard, refer to the section of [5.8 Parameter Setting](#). Select this parameter and use the Multipurpose rotary knob to change the middle field 1. The range can be set to 0~32.

n. Data bit

Click on the “Data bit” text field to pop up the numeric keyboard to enter the data bit. For details on the use of the numeric keyboard, refer to the section of [5.8 Parameter Setting](#). Select this parameter and use the Multipurpose rotary knob to change the data bit. The range can be set to 1~255.

o. Bit size

Click on the “Bit size” text field to pop up the numeric keyboard to enter the bit size. For details on the use of the numeric keyboard, refer to the section of [5.8 Parameter Setting](#). Select this parameter and use the Multipurpose rotary knob to change the bit size. The range can be set to 1~8.

p. Middle field 3

Click on the “Middle field 3” text field to pop up the numeric keyboard to enter the middle field 3. For details on the use of the numeric keyboard, refer to the section of [5.8 Parameter Setting](#). Select this parameter and use the Multipurpose rotary knob to change the middle field 3. The range can be set to 0~32.

q. End field

Click on the “End field” text field to pop up the numeric keyboard to enter the end field. For details on the use of the numeric keyboard, refer to the section of [5.8 Parameter Setting](#). Select this parameter and use the Multipurpose rotary knob to change the end field. The range can be set to 0~32.

r. Inter-frame space

Click on the “Inter-frame space” text field to pop up the numeric keyboard to enter the inter-frame space. For details on the use of the numeric keyboard, refer to the section of [5.8 Parameter Setting](#). Select this parameter and use the Multipurpose rotary knob to change the inter-frame space. The range can be set to 0~32.

(2) Decoding bus setting

a. Bus switch

Click on the “Bus switch” to switch on/off the bus function.

b. Decoding line

Set the display position of decoding bus on the screen. The display position of decoding line can be adjusted by using Multipurpose rotary knob; or double-click on the “Decoding line” text field to pop up the numeric keyboard to set the position. The range can be set to 0~560.

c. Format

Set the display format for the decoding bus and event list decoding, click on the “Format” to select hexadecimal, decimalism or binary.

d. Label

Click on the “Label” to switch on/off the decoding bus label. When the decoding bus label is switched on, it will display on the left top and display current protocol type. When the decoding bus label is switched off, it will not be displayed.

(3) Event list

Click on the “Event list” to switch on/off the event list. When the event list is switched on, it will be displayed as shown in the following figure. Click the event list icon on the right top to close it.



(4) Save event list

When the operating state is RUN/STOP, the time and decoding data in the current event list can be exported.

Click the “Save event list” key in the decoding menu to pop up the export setting menu, the data can be saved in *.csv , *.html and *.pdf to internal storage or external USB (when a USB is detected).

For the setting steps, refer to the section of [Storage and Load](#).

Note: When the operating state is RUN, the decoding data may be unstable, the user can manually stop the oscilloscope to export a stable decoding signal.

(5) Trigger menu

Click on the “Trigger” to directly access the trigger menu and the trigger mode is the same as the decoding type.

9.11. SENT Decoding

SENT (Single Edge Nibble Transmission) protocol is a point-to-point, unidirectional transmission scheme introduced by SAE, which is used for data transmission between on-board sensors and electronic control units (ECUs).

SENT high and low signal level requirements: 0~0.5V for logic level 0, 4.1~5V for logic level 1.

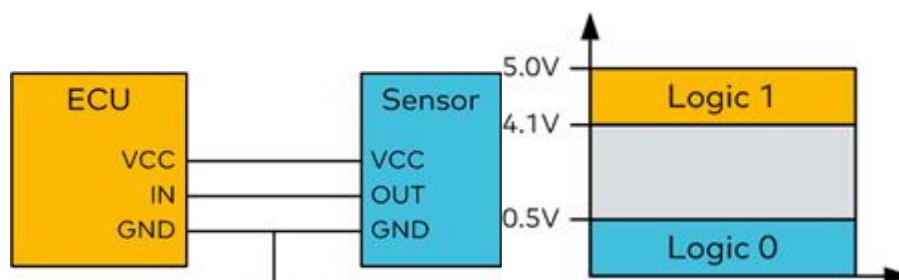

The data of the SENT protocol is coded using a half-byte nibble, i.e. 4 bits, and a half-byte nibble is defined by the time difference between two falling edges.

(1) Decoding parameter setting

a. Protocol type

Click on the “Protocol type” to select “SENT”.

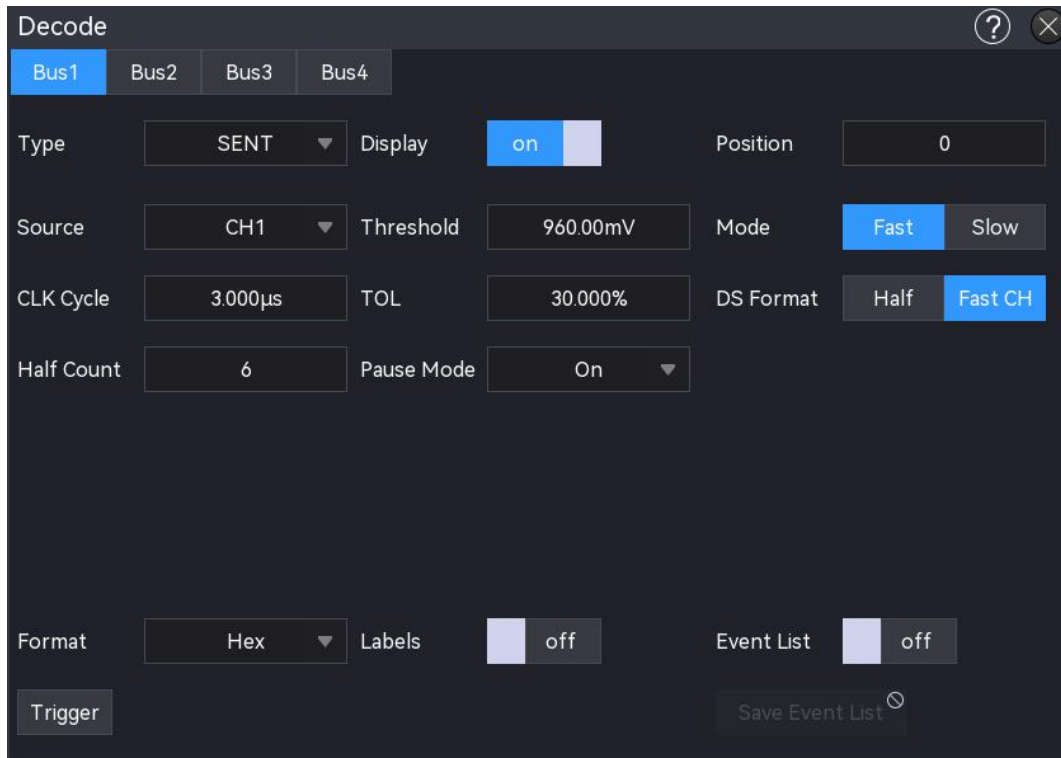

b. Source

Click on the “Source” to select CH1-CH4, D0~D15, and refer to the section of [Trigger Source](#) for more details. The current source is displayed in the trigger label on the top of the screen.

The source can only be triggered stably when the selected channel has a connected signal and to be the trigger source.

c. Threshold

Double-click on the “Threshold” text field to pop up the numeric keyboard to set the Threshold; or rotate the [Multipurpose](#) rotary knob to adjust the Threshold.

d. Mode

Click on the “Mode” to switch the trigger signal mode to fast or slow.

e. Clock period

Tap to select the “Clock period” and use the [Multipurpose](#) rotary knob to change the clock period; or double-click on the “Clock period” text field to pop up the numeric keyboard to set the clock period. For details on the use of the numeric keyboard, refer to the section of [5.8 Parameter Setting](#).

f. Tolerance

Set the percentage tolerance to specify a percentage tolerance for determining whether the sync pulse is valid for decoding data. If the time of the measured sync pulse is within the percentage tolerance of the rated clock period, then the decoding will continue,

otherwise, the sync pulse occurs an error and data decoding will not be performed.

g. Half byte

Set the half byte for fast channel message, double-click on “Half byte” text field to pop up the numeric keyboard to set the half byte; or rotate the Multipurpose rotary knob to adjust the half byte ; or press the trigger Position rotary knob to change the half byte.

h. Pause mode

Click on the “Pause mode” to set whether there is a pause pulse between the fast channel messages. It can be switched to ON or OFF.

- OFF : There is no pause pulse between the fast channel messages.

There is no idle time on the SENT serial bus without pause pulses. This means that during normal operation the fast channel decode line shows a continuous stream of packets, i.e. one packet closes and a new packet opens immediately.

- ON: Add a pause pulse between the fast channel messages, so that the frames arrive at equal intervals.

If there is a pause pulse (switch on), the idle time will display between the messaged.

i. Data field format

Set the display format of decoding data field, it can set to half byte or fast channel.

- Half byte: The decoding data of data field is displayed in half byte.
- Fast channel: The decoding data of data field is displayed together.

(2) Decoding bus setting

a. Bus switch

Click on the “Bus switch” to switch on/off the bus function.

b. Decoding line

Set the display position of decoding bus on the screen. The display position of decoding line can be adjusted by using Multipurpose rotary knob; or double-click on the “Decoding line” text field to pop up the numeric keyboard to set the position. The range can be set to 0~560.

c. Format

Set the display format for the decoding bus and event list decoding, click on the “Format” to select hexadecimal, decimalism or binary.

d. Label

Click on the “Label” to switch on/off the decoding bus label. When the decoding bus label is switched on, it will display on the left top and display the current protocol type. When the decoding bus label is switched off, it will not be displayed.

(3) Event list

Click on the “Event list” to switch on/off the event list. When the event list is switched on, it will be displayed as shown in the following figure. Click the event list icon on the right top to close it.

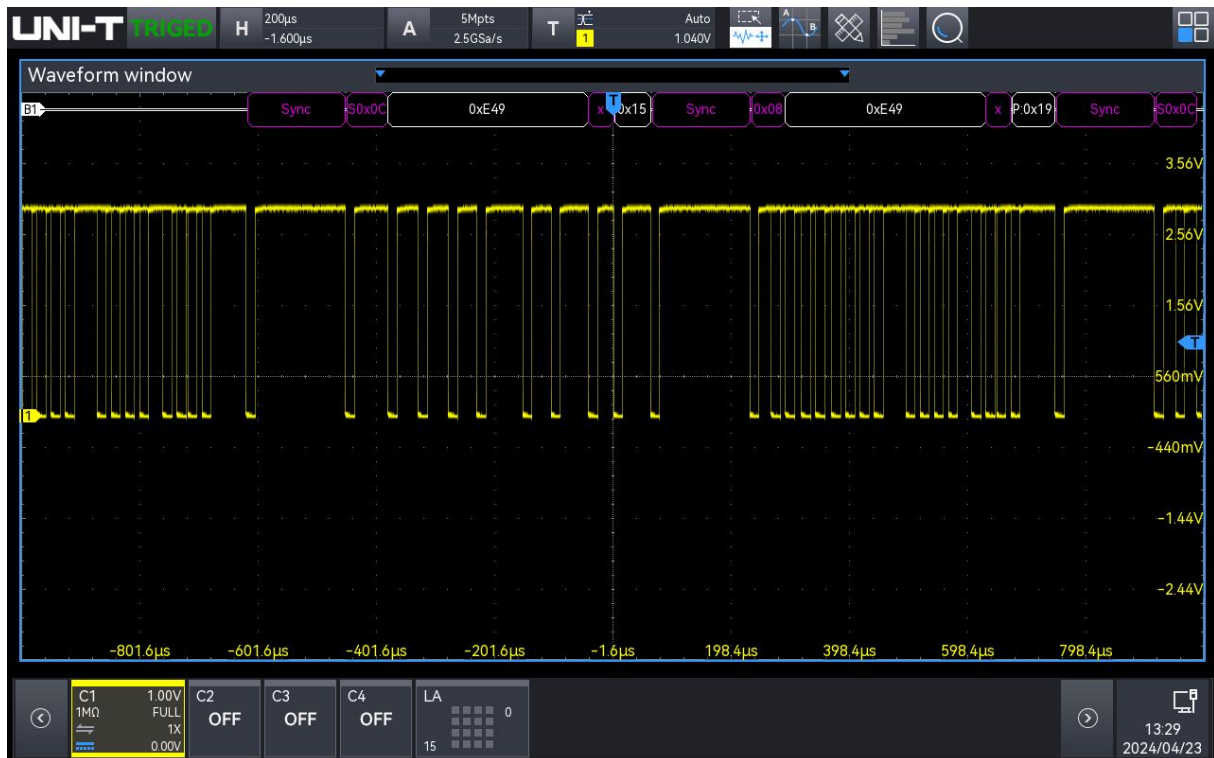

(4) Save event list

When the operating state is RUN/STOP, the time and decoding data in the current event list can be exported.

Click the “Save event list” key in the decoding menu to pop up the export setting menu, the data can be saved in *.csv , *.html and *.pdf to internal storage or external USB (when a USB is detected).

For the setting steps, refer to the section of [Storage and Load](#).

Note: When the operating state is RUN, the decoding data may be unstable, the user can manually stop the oscilloscope to export a stable decoding signal.

(5) Trigger menu

Click on the “Trigger” to directly access the trigger menu and the trigger mode is the same as the decoding type.

9.12. ARINC429 Decoding

The ARINC 429 bus is a serial standard, interface-oriented, unidirectional broadcast transmission bus.

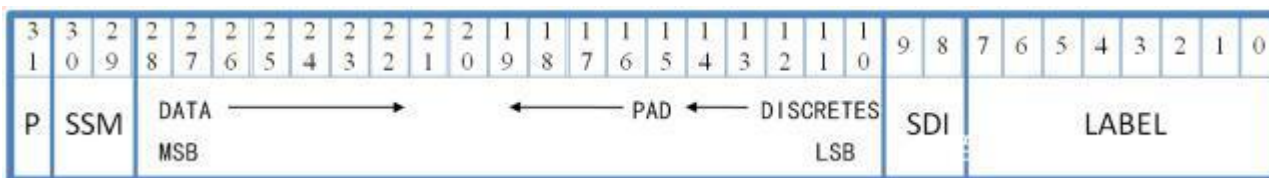

(1) Decoding parameter setting

a. Protocol type

Click on the “Protocol type” to select “ARINC429”.

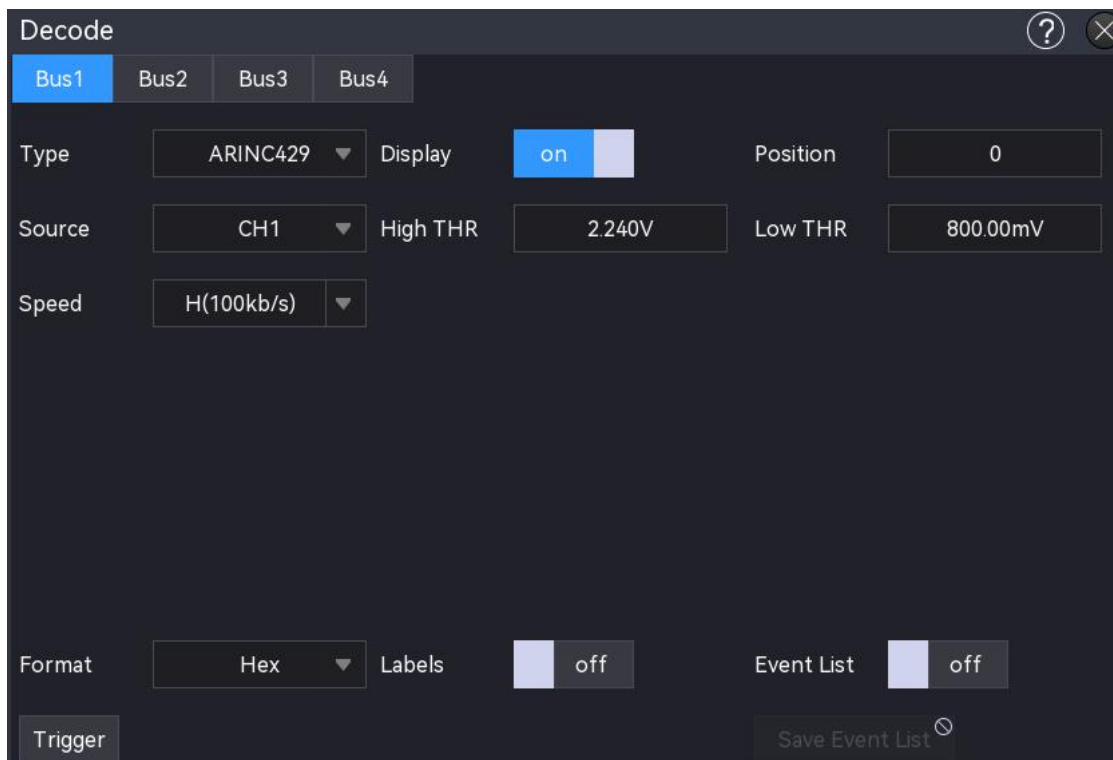

b. Source

Click on the “Source” to select CH1~CH4 and refer to the section of [Trigger Source](#) for more details. The current source is displayed in the trigger label on the top of the screen.

The source can only be triggered stably when the selected channel has a connected signal and to be the trigger source.

c. Threshold (High/Low)

Double-click on “Threshold (High/Low)” text field to pop up the numeric keyboard to set the threshold; or rotate the [Multipurpose](#) rotary knob to adjust the threshold.

d. Speed

Click on the “Speed” to set the transmission rate to high (100kb/s), low (12.5kb/s) or custom.

(2) Decoding bus setting

a. Bus switch

Click on the “Bus switch” to switch on/off the bus function.

b. Decoding line

Set the display position of decoding bus on the screen. The display position of decoding line can be adjusted by using Multipurpose rotary knob; or double-click on the “Decoding line” text field to pop up the numeric keyboard to set the position. The range can be set to 0~560.

c. Format

Set the display format for the decoding bus and event list decoding, click on the “Format” to select hexadecimal, decimalism or binary.

d. Label

Click on the “Label” to switch on/off the decoding bus label. When the decoding bus label is switched on, it will display on the left top and display the current protocol type. When the decoding bus label is switched off, it will not be displayed.

(3) Event list

Click on the “Event list” to switch on/off the event list. When the event list is switched on, it will be displayed as shown in the following figure. Click the event list icon on the right top to close it.



(4) Save event list

When the operating state is RUN/STOP, the time and decoding data in the current event list can be exported.

Click the “Save event list” key in the decoding menu to pop up the export setting menu, the data can be saved in *.csv , *.html and *.pdf to internal storage or external USB (when a USB is

detected).

For the setting steps, refer to the section of [Storage and Load](#).

Note: When the operating state is RUN, the decoding data may be unstable, the user can manually stop the oscilloscope to export a stable decoding signal.

(5) Trigger menu



Click on the “Trigger” to directly access the trigger menu and the trigger mode is the same as the decoding type.

10. Automatic Measurement

- [Parameter Measurement Overview](#)
- [Counter](#)
- [Voltmeter](#)
- [Parameter Snapshot](#)
- [Parameter Measurement](#)
- [Measurement Statistics](#)
- [Add Measurement](#)
- [Clear Added Measurement](#)
- [Global Setting](#)

MSO2000X/3000X measurement menu can access to all parameter measurement menu, including parameter snapshots, custom parameters, parameter statistics, counters, voltmeters, etc., as well as global settings for parameter measurements.

The “Measure” menu can be entered by the following steps.

- Press the Measure key on the front panel to enter the “Measure” menu.
- Click the Home icon  on the top right corner, and select the measurement icon  to enter the “Measure” menu.
- If the measurement is added to the toolbar, click the measurement icon  in the toolbar on the top right corner to enter the “Measure” menu.

10.1. Parameter Measurement Overview

MSO2000X/3000X series oscilloscope can automatically measure 54 kinds of parameter, such as voltage, time and other parameter.

- **Voltage Parameter**

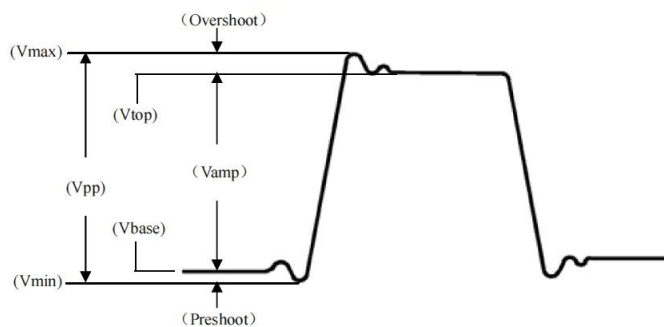

Maximum (V_{max}): The voltage from the highest point of the waveform to GND.

Minimum (V_{min}): The voltage from the lowest point of the waveform to GND.

Top (V_{top}): The voltage value from the flat top of the waveform to GND.

Bottom (V_{base}): The voltage value from the bottom of the waveform to GND.

Middle: Half of the sum of the voltage values at the top and bottom of the waveform

Peak-to-peak (V_{pp}): The voltage value from the highest point to the lowest point of the waveform.

Amplitude (V_{amp}): The voltage from top to bottom of the waveform.

Average (Mean): The average amplitude of the waveform in one cycle.

Root mean square (RMS): The energy generated by the conversion of AC signal, it corresponds to the DC voltage that generates equivalent energy.

RMS of cycle (CycRMS): The energy generated by the conversion of AC signal in one cycle, it corresponds to the DC voltage that generates equivalent energy.

AC RMS of cycle: Standard deviation of voltage value of waveform data in one cycle, which DC component has removed.

Area: The algebraic sum of the product of voltage and time for all points on the screen

Cycle area: The algebraic sum of the product of the voltage and the time at all the points in a cycle of the waveform.

Positive area: The algebraic sum of the product of all voltages and times on the screen greater than GND (ground).

Negative area: The algebraic sum of the product of all voltages and times on the screen less than GND (ground).

Positive cycle area: The algebraic sum of the product of all voltages and times greater than GND (ground) in a cycle.

Negative cycle area: The algebraic sum of the product of all voltages and times less than GND (ground) in a cycle.

Positive overshoot: The nearest extreme point after the signal along the rising edge of the waveform crosses the upper threshold limit.

Negative overshoot: The nearest extreme point after the signal along the falling edge of the waveform crosses the lower threshold limit.

Positive pre-shoot: The nearest extreme point before the signal along the rising edge of the waveform crosses the upper threshold limit.

Negative pre-shoot: The nearest extreme point before the signal along the falling edge of the waveform crosses the lower threshold limit.

■ Time Parameter

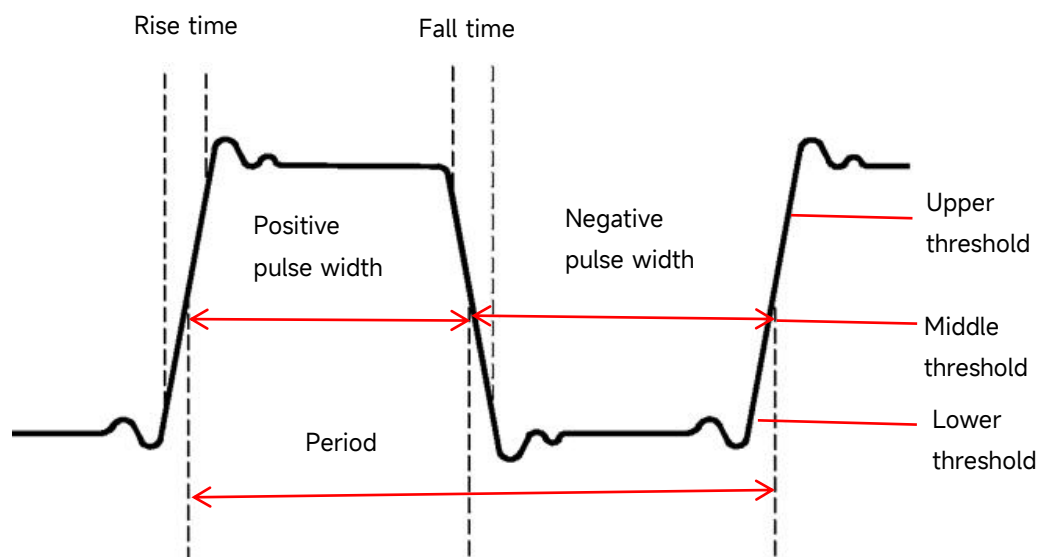

Period: The time between two consecutive, homopolar edges of a repetitive waveform with the same threshold median crossing point.

Frequency: The reciprocal of the cycle

Rise time: Time needed for waveform amplitude rising from the lower threshold to the upper threshold.

Fall time: Time needed for waveform amplitude rising from the upper threshold to the lower threshold.

Positive pulse width: The time difference between the time at the middle threshold on the rising edge of the pulse and the time at the middle threshold on the falling edge of the pulse immediately following.

Negative pulse width: The time difference between the time at the middle threshold on the falling edge of the pulse and the time at the middle threshold on the rising edge of the pulse immediately following.

Positive duty ratio: The ratio of the positive pulse width to period.

Negative duty ratio: The ratio of the negative pulse width to period.

Positive pulse number: The number of positive pulse from the lower threshold to the upper threshold.

Negative pulse number: The number of negative pulse from the upper threshold to the lower threshold.

Rising edge number: The number of rising edge from the lower threshold to the upper threshold.

Falling edge number: The number of rising edge from the upper threshold to the lower threshold.

Burst width: Length of time that the intermediate reference level is exceeded more than once in a row.

Burst interval: The interval between two burst events.

Burst period: Burst period that satisfy burst width and burst interval.

Burst period number: The number that satisfy burst period.

■ Other Parameter

Ratio: The ratio of the AC effective voltages of the master and slave sources, expressed in dB.

Period ratio: The ratio of the periodic AC RMS voltages of the master and slave sources, expressed in dB.

Setup time: The time from when the specified intermediate reference level on the data source was exceeded to the last time the specified intermediate reference level on the clock source was exceeded.

Hold time: The time from when the specified intermediate reference level on the clock source was exceeded to the last time the specified intermediate reference level on the data source was exceeded.

Setup and Hold ratio: The ratio of the total time of setup time and hold time

FRFR: Time at the middle threshold intersection from the first rising edge of source 1 to the first rising edge of source 2.

FRFF: Time at the middle threshold intersection from the first rising edge of source 1 to the first falling edge of source 2.

FFFR: Time at the middle threshold intersection from the first falling edge of source 1 to the first rising edge of source 2.

FFFF: Time at the middle threshold intersection from the first falling edge of source 1 to the first falling edge of source 2.

FRLF: Time at the middle threshold intersection from the first rising edge of source 1 to the last falling edge of source 2.

FRLR: Time at the middle threshold intersection from the first rising edge of source 1 to the last rising edge of source 2.

FFLR: Time at the middle threshold intersection from the first falling edge of source 1 to the last rising edge of source 2.

FFLF: Time at the middle threshold intersection from the first falling edge of source 1 to the last falling edge of source 2.



Phase (r-r): The phase offset between the rising edge of the master source and the rising edge of the slave source at the median waveform threshold, expressed in degrees.

Phase (f-f): The phase offset between the falling edge of the master source and the falling edge of the slave source at the median waveform threshold, expressed in degrees.

10.2. Counter

The counter analysis function provides counting measurements of frequency, period or product on any analogue channel.

The counter function can be entered by the following steps.

- Press the **Measure** key on the front panel, click on the “Counter” in the “Measure” menu to open the counter analysis function.
- Click the Home icon on the top right corner, and select the counter icon  to pop up the counter box to switch on the counter analysis function.
- Click the counter icon  in the toolbar on the top right corner, to pop up the counter box to switch on the counter analysis function.

The results of count measurement is displayed above the volts/div box. Counter analysis can be used for multiple channels.

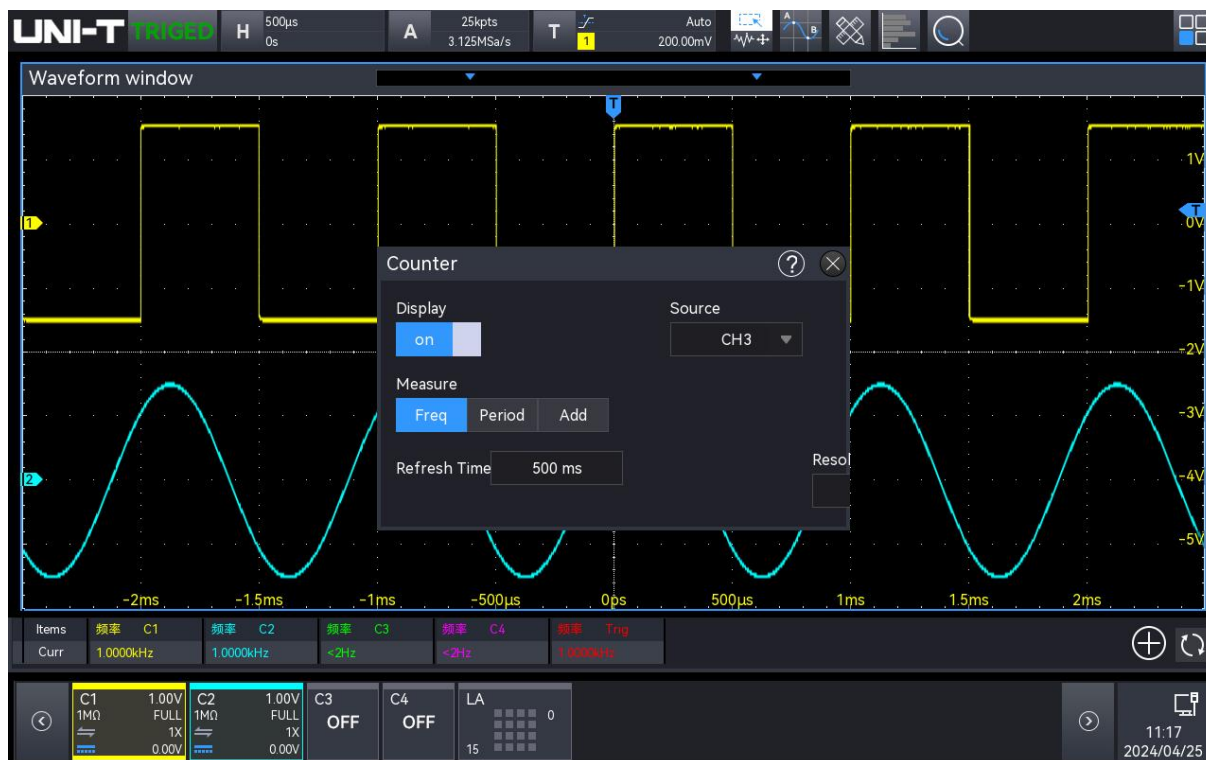

(1) Counter setting

Once the counter is enabled, tap the counter parameter to pop up the counter box to set the display state, source, test type, refresh time, effective digit and clear count.

a. Display state

Click on the “Display” to switch on/off the counter display.

ON: The result of count measurement will be displayed on the bottom of the screen.

b. Source

Click on the “Source” to select the source to be tested, CH1~CH4 and trigger source can all be the source.

c. Test type

Select the “Frequency”, “Period” or “Accumulation” parameter to be tested. “Accumulation” is the counting of signal edge events.

d. Refresh time

Set the refresh time for the results of count measurement. Click on the “Refresh time” text field to rotate the Multipurpose rotary knob to change the time; or double-click on the “Refresh time” text field to pop up the numeric keyboard to set the time. The time range can be set to 200 ms~10 s.

e. Effective digit

The display bit of the counter measured results can be set in the “Frequency”, “Period” parameter. Click on the “Effective digit” text field to rotate the Multipurpose rotary knob to change the effective digit; or double-click on the “Effective digit” text field to pop up the

numeric keyboard to set the effective digit. The range of effective digit can be set to 3~7.



f. Clear count

If the “Accumulation” is selected and the count of signal edge event is being measured, click on the “Clear count” to delete the count results and restart the count measurement.

10.3. Voltmeter

The built-in digital voltmeter (DVM) of this oscilloscopes can measure 4 effective digits of voltage on any analogue channel. DVM measurements are asynchronous to the oscilloscope's acquisition system and are always acquired.

DVM measurement can be entered by the following steps.

- Press the **Measure** key on the front panel, click on the “Voltmeter” in the “Measure” menu to open the voltmeter measurement.
- Click the Home icon on the top right corner, and select the voltmeter icon  to pop up the voltmeter box to switch on the voltmeter measurement.
- Click the voltmeter icon  in the toolbar on the top right corner, to pop up the voltmeter box to switch on the voltmeter measurement.

The results of voltmeter measurement is displayed above the volts/div box. Voltmeter measurement can be used for multiple channels.



(1) Voltmeter setting

Once the voltmeter is enabled, tap the voltmeter parameter to pop up the voltmeter box to set

the display state, source, test type, refresh time and beep.

a. Display state

Click on the “Display” to switch on/off the voltmeter display.

ON: The result of voltmeter measurement will be displayed on the bottom of the screen.

b. Source

Click on the “Source” to select the source to be tested, CH1~CH4 can be the source. DVM measurement can be performed even if CH1~CH4 is not opened.

c. Test type

- DC: Display the average of the collected data.
- AC RMS: Display RMS of the collected data that the DC component has removed.
- DC+AC RMS: Display RMS of the collected data.

d. Refresh time

Set the refresh time for the results of count measurement. Click on the “Refresh time” text field to rotate the Multipurpose rotary knob to change the time; or double-click on the “Refresh time” text field to pop up the numeric keyboard to set the time. The time range can be set to 200 ms~10 s.

(2) Beep setting

Set the display state, limit condition and the lower/upper limit of the beep.

a. Display state

- Click on the “Display” to switch on/off the beep.
- ON: The oscilloscope will have an alarm if the test result meets the condition, otherwise, the alarm will not be sound.

b. Limit condition

- >: The oscilloscope will have an alarm if the DVM value is greater than the set lower limit, and the lower limit can be set.
- <: The oscilloscope will have an alarm if the DVM value is less than the set upper limit, and the upper limit can be set.
- <>: The oscilloscope will have an alarm if the DVM value is greater than the set lower limit and less than the set upper limit, and the upper/lower limit can be set.
- ><: The oscilloscope will have an alarm if the DVM value is less than the set lower limit and greater than the set upper limit, and the upper/lower limit can be set.

c. Upper/Lower limit

The set voltage is compared to DVM value and the range can be set to -20 V~20 V.

- When the trigger condition is “>” or “<”, click on the “Lower” or “Upper” text field to pop up the numeric keyboard to set the lower/upper limit; or rotate the Multipurpose

rotary knob to change the lower/upper limit.

- When the trigger condition is “<>” or “><” click on the “Lower” or “Upper” text field to pop up the numeric keyboard to set the lower/upper limit; or rotate the Multipurpose rotary knob to change the lower/upper limit. The lower limit should less than the upper limit.

10.4. Parameter Snapshot

The parameter snapshot is used to display one parameter that has performed an automatic measurement.

Press the **Measure** key on the front panel, click on the “Parameter snapshot” in the “Measure” menu to pop up the parameter snapshot box.



In the parameter snapshot box, click on the “Source” to select the source to be tested, CH1~CH4, Math1~Math4 can be selected.

The color of measured results is consistent with the color of all sources.

10.5. Parameter Measurement

Press the **Measure** key on the front panel, click on the “Parameter measurement” in the “Measure” menu to open the parameter measurement. The parameter measurement info box will not be displayed if the parameter measurement is not ticked.



The parameter measurement is displayed above volts/div info box, showing the measure parameter and the current value. During the measurement, the counter, voltmeter is displayed on the far left by default, and the custom parameter follow behind. The parameter measurement supports the setting of up to 27 parameters.

The custom parameter measurement in the parameter measurement info box can be cancelled by clicking "-" in the top right corner.

10.6. Measurement Statistics

Press the **Measure** key on the front panel, tick on the "Measurement statistics" in the "Measure" menu to open the measurement statistics. The statistic results of all parameter measurement is displayed in the "Parameter measurement" box at the bottom of screen

Statistics: current value, maximum, minimum, average value, standard deviation, count and statistical diagram.

Once the measurement statistics is enabled, a statistical diagram based on the average value can be generated. There are two types of statistical diagram: histogram and tendency chart.

Select the statistical diagram by clicking on the diagram switch below "Measure" items on the far left.



10.7. Add Parameter

Add the parameter to be tested to the parameter measurement info box, enter the “Add parameter” menu by the following steps.

- Press the **Measure** key on the front panel, click on the “Add parameter” in the “Measure” menu to enter the add parameter menu.
- Click on the icon ⊕ in the parameter measurement info box to enter the add parameter menu.

In the add parameter menu, switch different parameter menu by clicking on the “Vertical”, “Horizontal”, “Other” or slide the menu to left or right, and Select this parameter to enter the related measurement. This oscilloscope supports up to 27 kinds of parameter measurements to be opened at the same time.

- Vertical parameter: maximum, minimum, peak-to-peak, top, bottom, amplitude, middle value, average value, period average, RMS (root mean square), RMS of cycle, AC RMS, AC RMS of cycle, area, cycle area, positive area, negative area, positive cycle area, negative cycle area, positive overshoot, negative overshoot, positive preshoot, negative preshoot.



- Horizontal parameter: period, frequency, rise time, fall time, positive pulse width, negative pulse width, positive duty ratio, negative duty ratio, positive pulse width number, negative pulse width number, rising edge, falling edge, rising edge number, falling edge number, burst width, burst interval, burst period, burst period number.

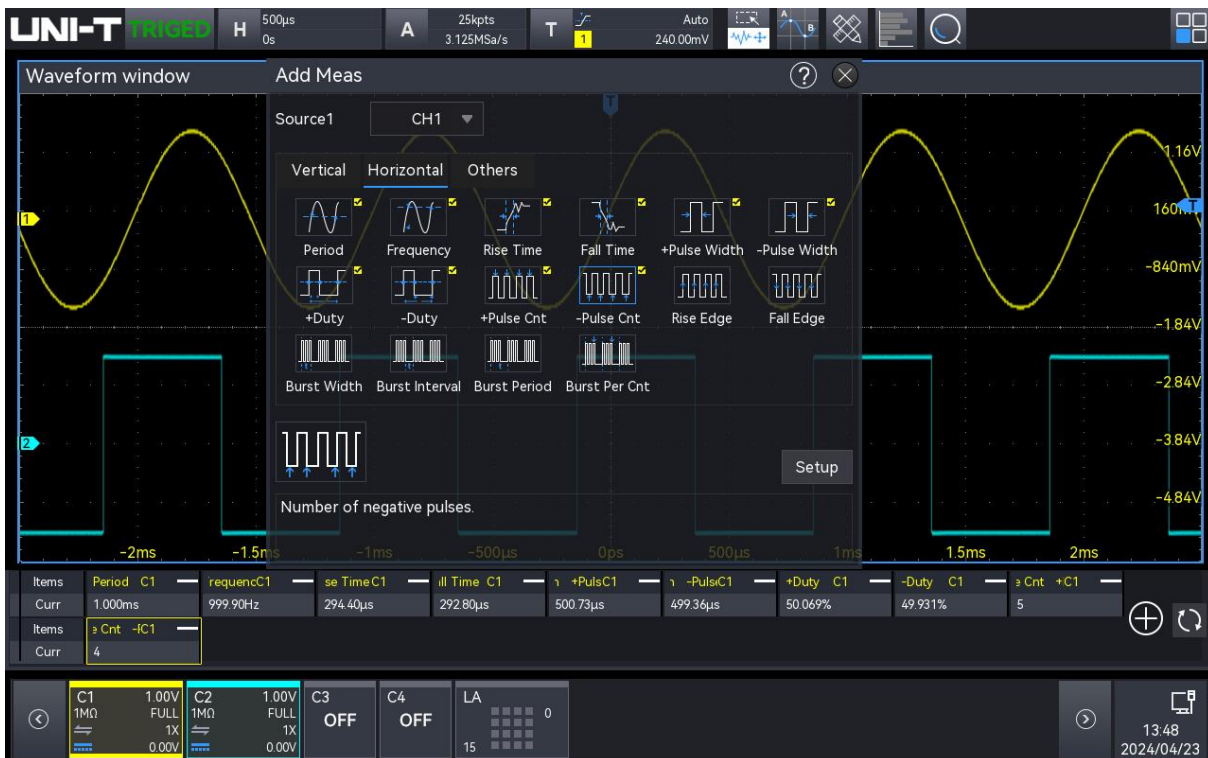

- Other parameter: ratio, period ratio, setup time, hold time, setup and hold ratio, FRFR, FRFF, FFFR, FFFF, FRLF, FRLR, FFLR, FFLF, phase (r-r), phase (f-f).

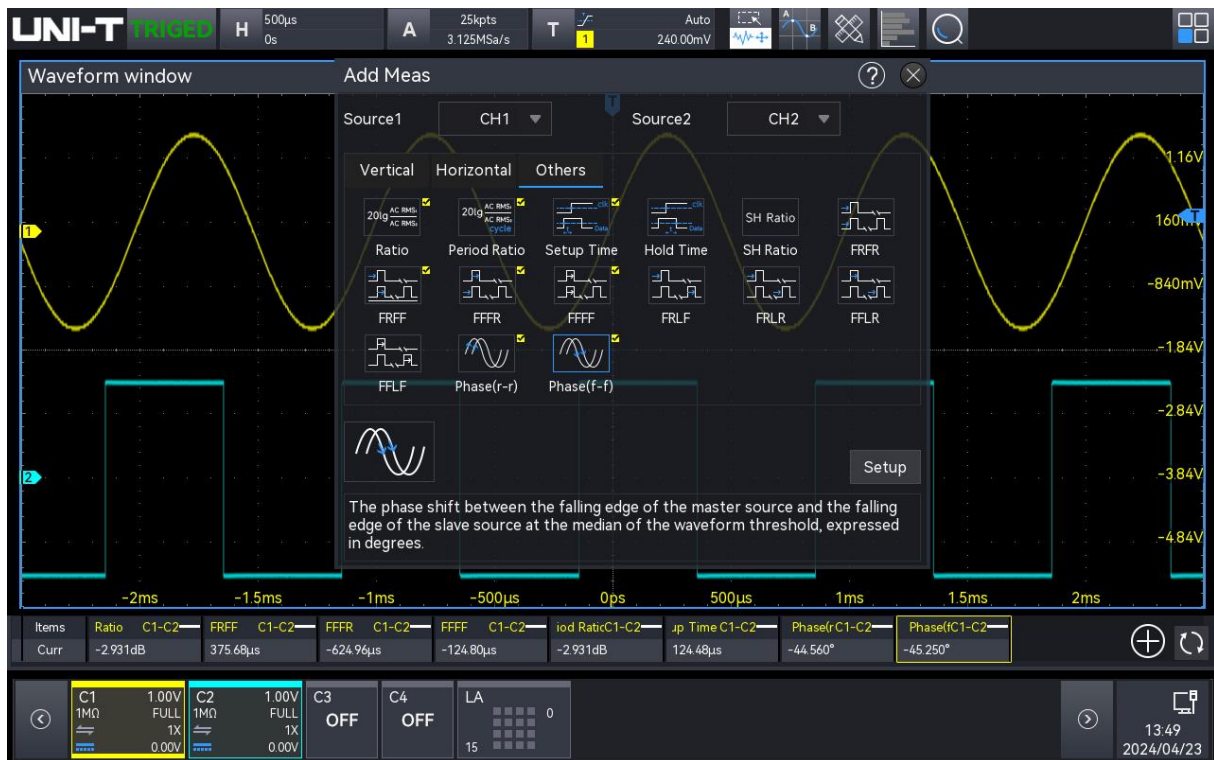

10.8. Clear Added Measurement

This oscilloscope allows the user to delete all added measurements.

- In the “Add measurement” menu, click on the added parameter to select and to delete.
- In the results window at the bottom of screen, click on the “-” in the top right corner of any measurement to delete the currently selected measurement.
- Press the **Measure** key on the front panel, click on the “Clear” in the “Measurement” menu to delete all added measurements.

10.9. Global Setting

Press the **Measure** key on the front panel, click on the “Global setting” in the “Measurement” menu to enter the “Advanced setting” menu.

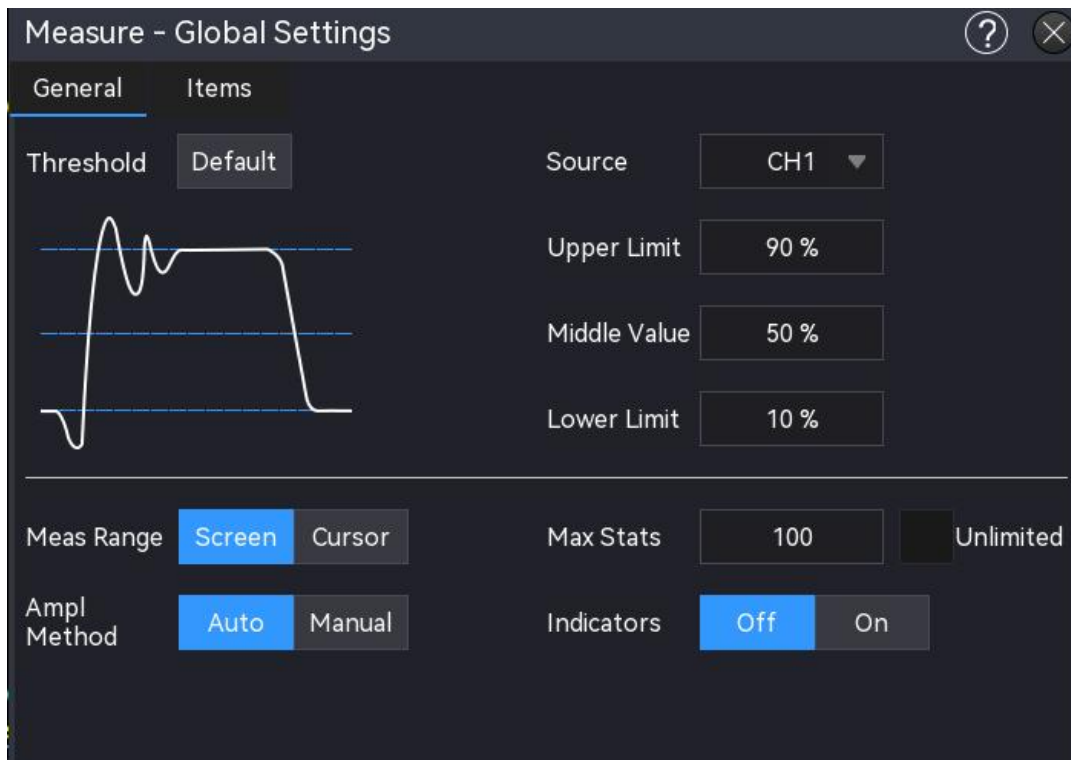

The general and measurement settings can be set in the “Advanced setting” menu.

(1) General setting

a. Threshold

- **Default:** click on the “Default” to restore the upper limit, middle value and lower limit to default value.
- **Source:** click on the “Source” to select the channel to be measured, CH1~CH4, Math1~Math4 can be selected.
- **Upper limit:** set the upper limit of reference level for waveform measurement. Click on the “High” text field to pop up the numeric keyboard to set the upper limit; or rotate the Multipurpose rotary knob adjust the upper limit. The default percentage is 90%, and the range can be set to 7%~95%.
- **Middle value:** set the middle value of reference level for waveform measurement. Click on the “Middle” text field to pop up the numeric keyboard to set the middle value; or rotate the Multipurpose rotary knob adjust the middle value. The default percentage is 50%, and the range can be set to 6%~94%.
- **Lower limit:** set the lower limit of reference level for waveform measurement. Click on the “Low” text field to pop up the numeric keyboard to set the lower limit; or rotate the Multipurpose rotary knob adjust the lower limit. The default percentage is 10%, and the range can be set to 5%~93%.

b. Measure range

The measure window on the horizontal direction, it will affect the results of all parameter

measurement. The measure range can be set to screen area or cursor area.

- Screen area: full screen
- Cursor are: the horizontal time cursor area allows the user to set the cursor position as required and to measure the results directly within the cursor area.

c. Maximum count

It is custom parameter. If the measurement statistics are switched on, the number of statistics can be set to 10~10000, or check unlimited times.

d. Amplitude calculation strategy

The amplitude measure mode can be set to auto or manual. The strategy affects the measure strategy of top and bottom value.

- Auto: according to the input signal, the amplitude calculation strategy is automatically selected.
- Manual: based on the manually selected top and bottom strategy, the corresponding amplitude values are calculated.

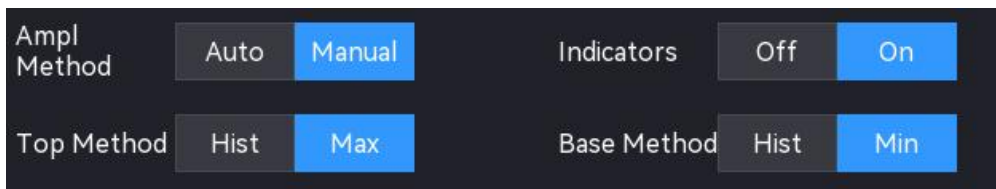

e. Top calculation strategy

- Histogram: counting the value that greater than the peak-to-peak 1/2, the highest probability is recognized as the top value.
- Maximum: the maximum of waveform is recognized as the top value.

f. Bottom

- Histogram: counting the value that less than the peak-to-peak 1/2, the highest probability is recognized as the bottom value.
- Minimum: the minimum of waveform is recognized as the bottom value.

g. Indicator

Click on the "Indicator" to switch on/off the indicator.

When the cursor indicator is switched on, one or more cursors appear on the screen. Before opening the cursor indicator, at least one automatic measurement parameter should be opened, and the number of cursors will change according to the measurement parameter.

(2) Measure setting

a. Burst

- Idle time: set the idle time for the measurement of burst width, burst interval, burst period and burst period number.



- Idle level: high or low level
- b. Setup & hold setting
- Clock edge: rising edge, falling edge or random edge
 - Data edge: rising edge, falling edge or random edge

11. Power Analysis

- [Power Quality](#)
- [Harmonics Analysis](#)
- [Surge Current](#)

This oscilloscope supports power analysis function (option), it can help the user to quickly analyze the efficiency and reliability of switch power. With this function, the user can analyze the power quality, harmonics analysis and surge current of the input power

The power analysis menu can be entered by the following steps.

- Click the Home icon  on the top right corner, and select the power analysis icon  to enter the “Power Analysis” menu.
- If the power analysis is added to the toolbar, click the power analysis icon  in the toolbar on the top right corner to enter the “Power Analysis” menu.

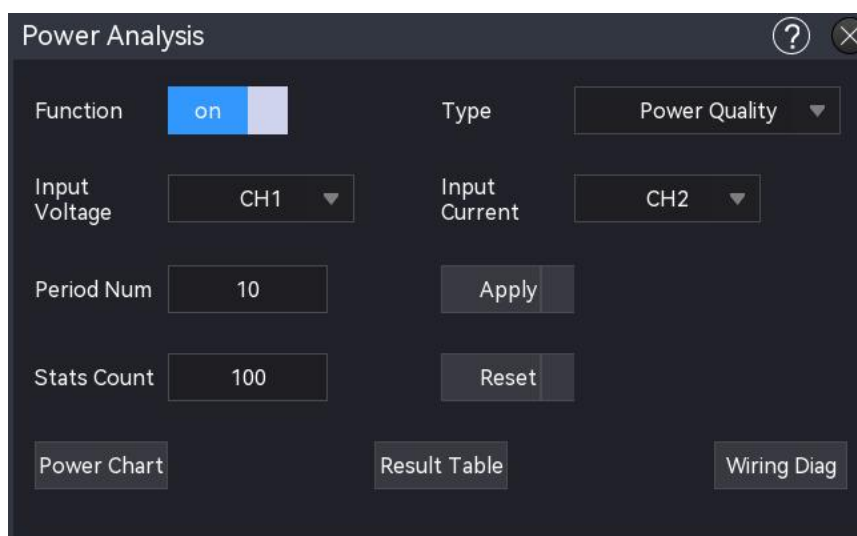

11.1. Power Quality

The power quality can measure the quality of AC input wire. The measuring parameter of power quality analysis includes the voltage peak, RMS voltage, voltage peak factor, current peak, RMS current, current peak factor, active power, reactive power, apparent power, power factor and power phase angle.

- (1) Analysis mode

Click on the “Analysis Mode” to select “Power Quality”.

- (2) Function switch

Click on the “Function Switch” to switch the power analysis ON/OFF.

(3) Wiring diagram

Click on the “Wiring Diagram” to display the wiring diagram of the power quality analysis, please follow the instructions to make the wiring connection, as shown in the following figure.

- Connect the voltage probe D+ to AC input live wire
- Connect the voltage probe D- to AC input zero wire
- Select the appropriate attenuation rate on the voltage probe
- Connect the current probe to AC input live wire, the arrow indicates the direction of the current flow
- Connect the voltage and current probe to the oscilloscope's channel

(4) Input voltage

Click on the “Input Voltage” to select the channel to collect voltage (CH1~CH4) , the voltage channel should set the unit and probe multiplying power according to the input voltage probe.

(5) Input current

Click on the “Input Current” to select the channel to collect voltage (CH1~CH4) , the current channel should set the unit and probe multiplying power according to the input current probe.

(6) Cycle number

Double click on the “Cycle Number” text field to pop up the numeric keyboard to set the cycle number. For details on the use of the numeric keyboard, refer to the section of [5.8 Parameter Setting](#); or select this parameter, and then rotate the Multipurpose rotary knob to change the cycle number, it can be set to 1~40.

(7) Statistics number

Double-click on the “Statistics Number” text field to pop up the numeric keyboard to set the statistics number. For details on the use of the numeric keyboard, refer to the section of [5.8 Parameter Setting](#); or select this parameter, and then rotate the Multipurpose rotary knob to change the statistics number, it can be set to 10~10000.

(8) Application

Click on the “Application” key, the oscilloscope will be automatically set by the user-defined input voltage, input current and cycle number (Note: multiply operation in Math function will also be automatically enabled) and perform the power quality analysis.

The measurement results are displayed in two forms, graph and result table.

- Graph result: voltage waveforms, current waveforms, power waveforms (power diagrams) are product of the current waveform and voltage waveform
- Result table: the statistic results are displayed in a table

(9) Reset

Click on the “Reset” key to clear the current data and restart to measurement statistics.

(10) Power diagram

Click on the “Power Diagram” key, the oscilloscope will open the multiply operation of Math1 by default and display the power waveforms.

(11) Result table

Click on the “Result Table” key to open the measurement results table of power quality analysis.

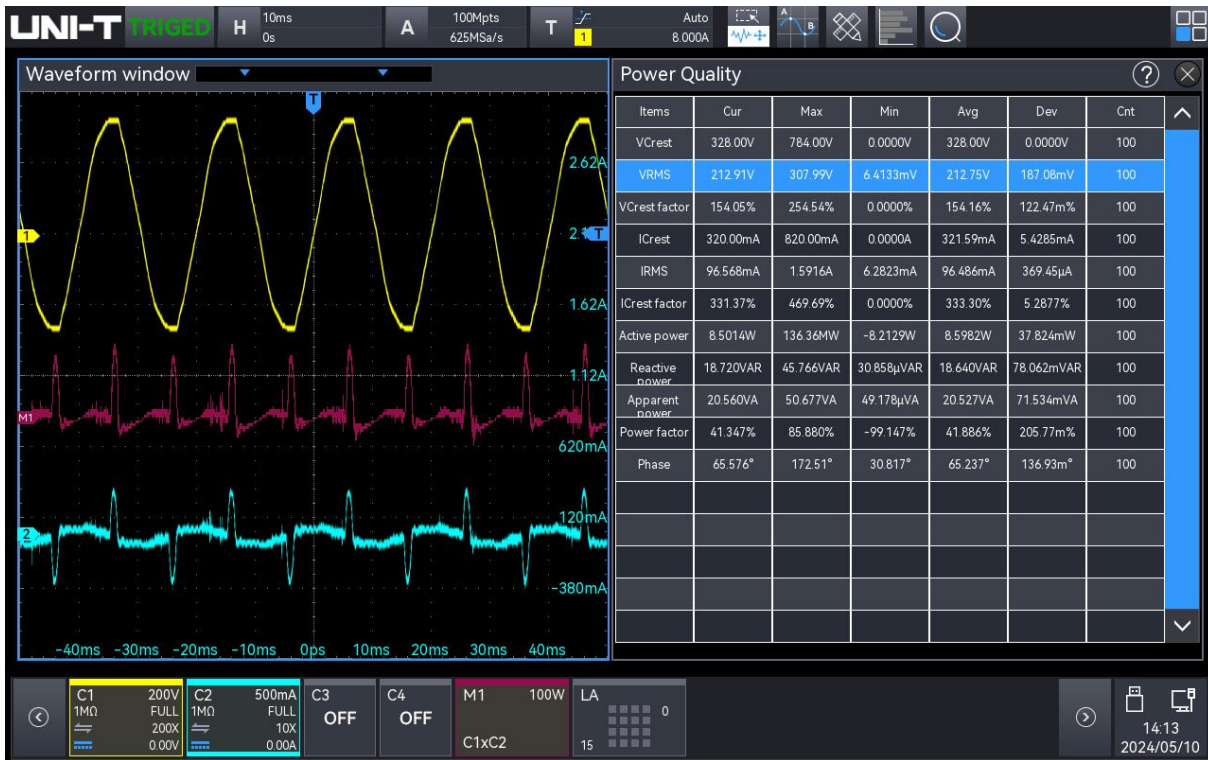

(12) Power quality measurement results

Voltage peak	Measure the voltage parameters at the input of the power supply, such as voltage peak, RMS voltage and voltage crest factor.
RMS voltage	Effective voltage value $V_{rms} = \frac{1}{N} * \sqrt{\sum_{i=0}^{N-1} V_i^2}$
Voltage peak factor	$V_Crest = V_{peak} / V_{rms}$
Current peak	Measure the current parameters at the input of the power supply, such as current peak, RMS current and current crest factor.
RMS current	Root mean square of current $I_{rms} = \frac{1}{N} * \sqrt{\sum_{i=0}^{N-1} I_i^2}$
Current peak factor	$I_Crest = I_{peak} / I_{rms}$
Active power	A portion of the power flux calculated by averaging over the entire period of the AC waveform that results in a net transfer of energy in one direction.
Reactive	Difference between apparent power and effective power caused by

power	reactance.
Apparent power	Due to the partial power flux generated by the stored energy, it is returned to the source in each cycle.
Power factor	The ratio of the actual power and the apparent power.
Power phase angle	In power triangle ($\text{apparent power}^2 = \text{active power}^2 + \text{reactive power}^2$), the phase angle is the angle between the apparent power and active power, it indicates the amount of reactive power.

11.2. Harmonics Analysis

Switching power supplies introduce a number of harmonics from the AC mains supply. Because these harmonics can be fed back into the supply circuit and cause problems for other equipment on the circuit, standard limits have been set for these harmonics. Standard limits are set for these harmonics because they can be transmitted back to the power circuit and cause problems with other equipment on the circuit.

Switching power supplies can be tested for harmonic analysis by IEC61000-3-2 pre-compliance standard (Class A, B, C or D). The analysis shows up to 40 harmonics.

(1) Analysis mode

Click on the "Analysis Mode" to select "Harmonic Analysis".

(2) Function switch

Click on the "Function Switch" to switch the power analysis ON/OFF.

(3) Wiring diagram

Click on the "Wiring Diagram" to display the wiring diagram of the current harmonics analysis, please follow the instructions to make the wiring connection, as shown in the following figure.

Close this wiring diagram by clicking on the icon at the top right of the wiring diagram.

- Connect the voltage probe D+ to AC input live wire
- Connect the voltage probe D- to AC input zero wire
- Select the appropriate attenuation rate on the voltage probe
- Connect the current probe to AC input live wire, the arrow indicates the direction of the current flow
- Connect the voltage and current probe to the oscilloscope's channel

(4) Input voltage

Click on the "Input Voltage" to select the channel to collect voltage (CH1~CH4) , the voltage channel should set the unit and probe multiplying power according to the input voltage probe.

(5) Input current

Click on the "Input Current" to select the channel to collect voltage (CH1~CH4) , the current

channel should set the unit and probe multiplying power according to the input current probe.

(6) Line frequency

Click on the “Line Frequency” to set the input line frequency, it can be set to auto acquire, 50 Hz, 60 Hz, 400 Hz.

(7) Harmonic standard

Click on the “Harmonic Standard” to select the test standard for harmonic analysis(IEC61000-3-2 A/B/C/D) .

- IEC61000-3-2 A: it suitable for balanced three-phase equipment, household appliances (except D-type), tools (except portable tools), incandescent lamp and audio frequency apparatus
- IEC61000-3-2 B: it suitable for portable tools
- IEC61000-3-2 C: it suitable for lighting equipment, press the Application softkey (in “Power Application” main menu), C-type should perform the power factor
- IEC61000-3-2 D: it suitable for the device that the rated power is less than or equal to 600W, the type is personal PC, personal computer monitor and television receiver

(8) Cycle number

Double click on the “Cycle Number” text field to pop up the numeric keyboard to set the cycle number. For details on the use of the numeric keyboard, refer to the section of [5.8 Parameter Setting](#); or select this parameter, and then rotate the Multipurpose rotary knob to change the cycle number, it can be set to 1~40.

(9) Application

Click on the “Application” key, the oscilloscope will be automatically set by the user-defined input voltage, input current and cycle number (Note: FFT1 automatically switched on to calculate current harmonics) and perform the harmonics analysis.

The measurement results are displayed in three forms, graph, result table and histogram.

- Graph result: voltage waveforms, current waveforms, harmonic analysis waveforms (FFT)
- Result table: the statistic results are displayed in a table
- Histogram: the current harmonic results are displayed in histogram

(10) Histogram

Click on the “Histogram” key to open the histogram of harmonic analysis.



(11) Result table

Click on the “Result Table” key to open the measurement results table of power quality analysis.

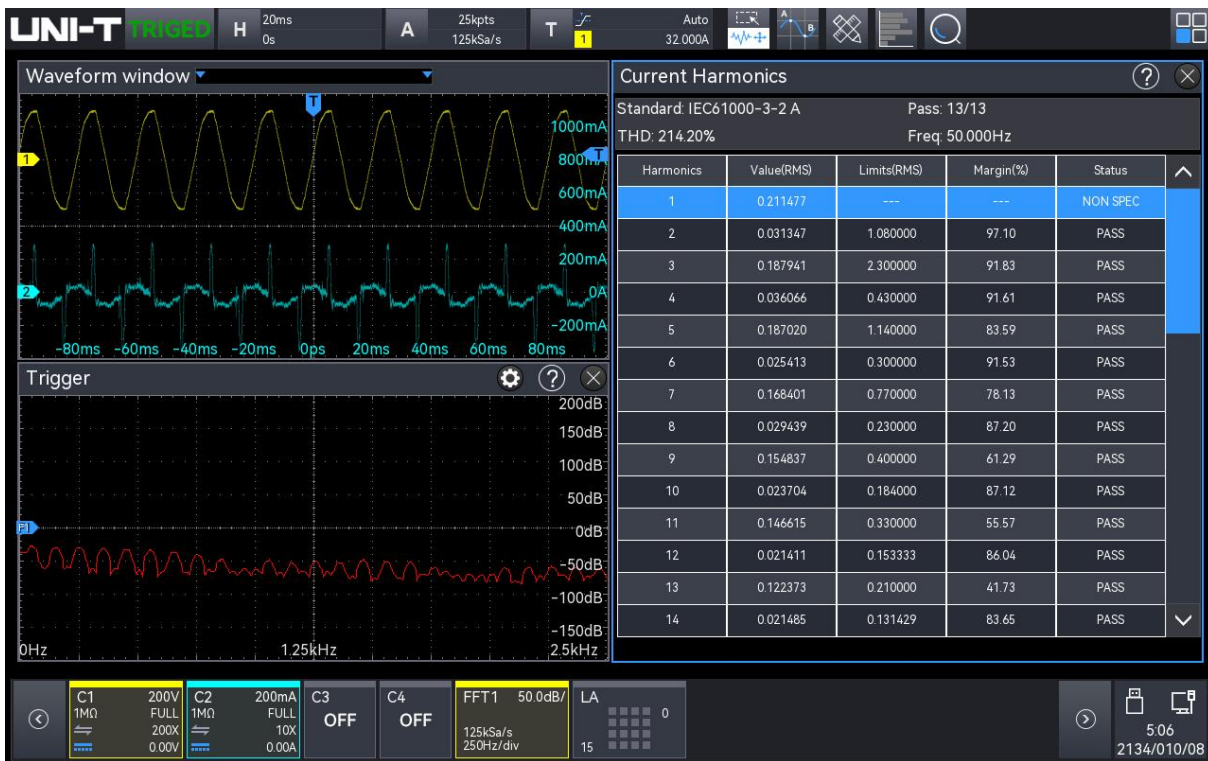

(12) Harmonic analysis measurement results

FFT waveforms	Display the frequency component in the input current. Using Hanning window to perform FFT.
Harmonic, actual value (RMS), limit	The following values are displayed for the first 40 harmonics. Actual value (RMS): The measured values are displayed with the

(RMS), margin, state	<p>unit that is specified by the Harmonic unit.</p> <p>Limit (RMS): Limit set by the selected harmonic analysis standard</p> <p>Margin: Margin set by the selected harmonic analysis standard.</p> <p>Pass/Fail: Whether the value passes or fails according to the selected harmonic analysis standard.</p> <p>Rows in a table or bars in a bar graph are colored according to the pass/fail value. The critical result is greater than 85% of the limit but less than 100% of the limit.</p>
THD (total harmonic distortion)	$THD = 100 \times \frac{\sqrt{X_2^2 + X_3^2 + X_n^2 + \dots}}{X_1}$ <p>Xn = voltage or current of each harmonic</p> <p>X1 = basic voltage or current</p>

11.3. Surge Current

Once the load is switched on, there is usually a large current, which called the surge current. For capacitive loads, this phenomenon is equivalent to a short circuit when the capacitor is switched on, and the instantaneous current is theoretically infinite.

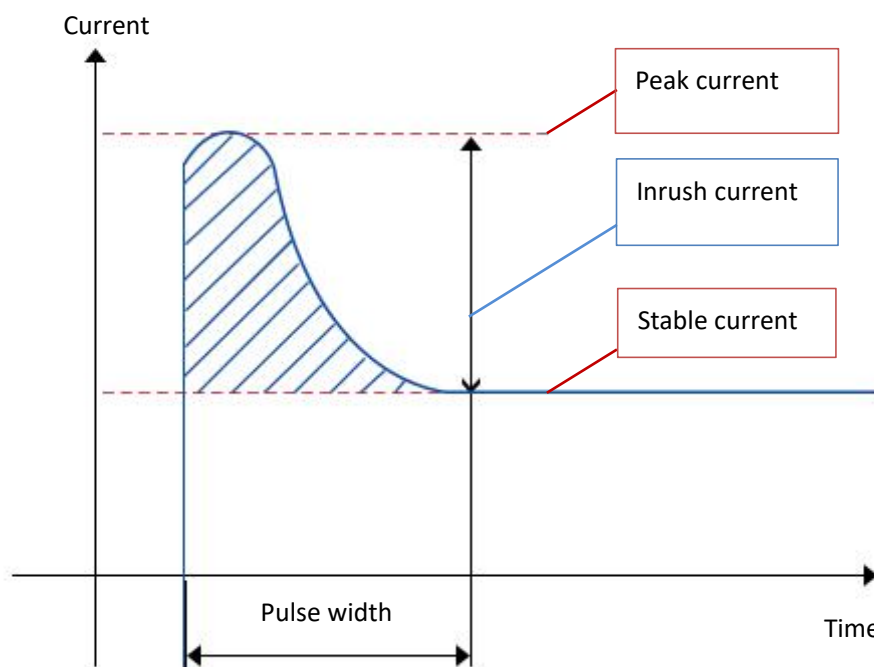

(1) Analysis mode

Click on the "Analysis Mode" to select "Surge Current".

(2) Function switch

Click on the "Function Switch" to switch the power quality ON/OFF.

(3) Wiring diagram

Click on the “Wiring Diagram” to display the wiring diagram of the power quality analysis, please follow the instructions to make the wiring connection, as shown in the following figure.

- Connect the voltage probe D+ to AC input live wire
- Connect the voltage probe D- to AC input zero wire
- Select the appropriate attenuation rate on the voltage probe
- Connect the current probe to AC input live wire, the arrow indicates the direction of the current flow
- Connect the voltage and current probe to the oscilloscope's channel

(4) Input voltage

Click on the “Input Voltage” to select the channel to collect voltage (CH1~CH4) , the voltage channel should set the unit and probe multiplying power according to the input voltage probe.

(5) Input current

Click on the “Input Current” to select the channel to collect voltage (CH1~CH4) , the current channel should set the unit and probe multiplying power according to the input current probe.

(6) Maximum input voltage (RMS)

Assign the maximum input voltage and set the vertical calibration of channel voltage.

Double click on the “Maximum Input Voltage (RMS)” text field to pop up the numeric keyboard to set the maximum input voltage. For details on the use of the numeric keyboard, refer to the section of [5.8 Parameter Setting](#); or select this parameter, and then rotate the Multipurpose rotary knob to change the maximum input voltage, it can be set to 1 V~1000 V.

(7) Prospective current

The prospective current is used to assign the expected inrush current amplitude and set the vertical calibration of channel current.

Double click on the “Prospective Current” text field to pop up the numeric keyboard to set the prospective current. For details on the use of the numeric keyboard, refer to the section of [5.8 Parameter Setting](#); or select this parameter, and then rotate the Multipurpose rotary knob to change the prospective current, it can be set to 100 mA~500 A.

(8) Application

Click on the “Application” key and follow the instructions on the screen. The result will be displayed after the analysis is complete.







12. Cursor Measurement

- [Time Measurement](#)
- [Voltage Measurement](#)
- [Screen Measurement](#)

Use the cursor to measure X axis (time) and Y axis (voltage) of the waveform. The cursor measurement supports simultaneous measurement of multiple channels, as well as Math wave and Ref wave. The source, test type and mode can be set in the cursor measurement menu.

- (1) Source: set the source for the cursor measurement, C1~C4, M1~M4, R1~R4 can be selected.
- (2) Test type: time, voltage, screen
- (3) Mode: set the cursor follow mode, independent: two cursor scan be set separately; follow: the position of two cursor is linked.

The cursor measurement can be entered by the following steps.

- Press the **Measure** key on the front panel, click on the "Cursor measurement" in the "Measure" menu to open the cursor measurement.
- Click the Home  icon on the top right corner, and select the counter icon  to switch on the cursor measurement.
- If the cursor icon is added to the toolbar, click on the cursor icon  in the toolbar on the top right corner to open the cursor measurement.
- If there is a cursor measurement results popups, click on the icon  to open the cursor measurement.

12.1. Time Measurement

In the "Cursor" menu to switch on the cursor, and click on the "Type" to select "Time" and then tick on the "Source" to be tested, as shown in the following figure.

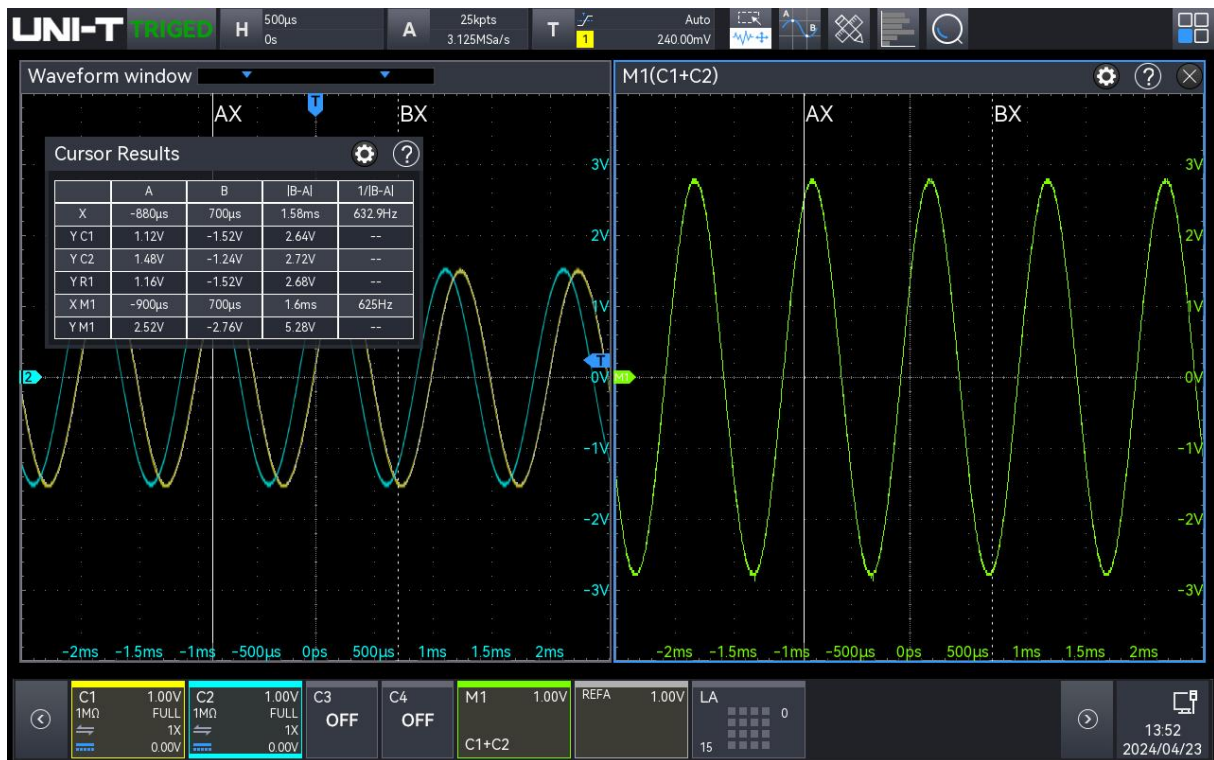

Cursor results info box: “X” represents the results of channel time measurement, “Y” represents the results of voltage measurement at the intersection of the open channel and the cursor.

Math wave supports split screen display, so when the cursor is measuring Math wave, it can also be displayed in split screen, allowing the cursor of each Math channel to be adjusted individually without affecting each other.

The position of AX and BX cursor can be set by the following methods.

- Use the Multipurpose rotary knob to move the cursor, clockwise: move to right; anticlockwise: move to left. Press the Multipurpose rotary knob to switch between AX and BX.
- Tap to select AX or BX, and drag the cursor to move to the right position, for the use of drag gesture, refer to the section of [Touch Screen](#).

12.2. Voltage Measurement

The voltage measurement is the same as the time measurement, adjusting the vertical position of the cursor and measuring the voltage of each cursor.

In the “Cursor” menu to switch on the cursor, and click on the “Type” to select “Voltage” and then tick on the “Source” to be tested, as shown in the following figure.

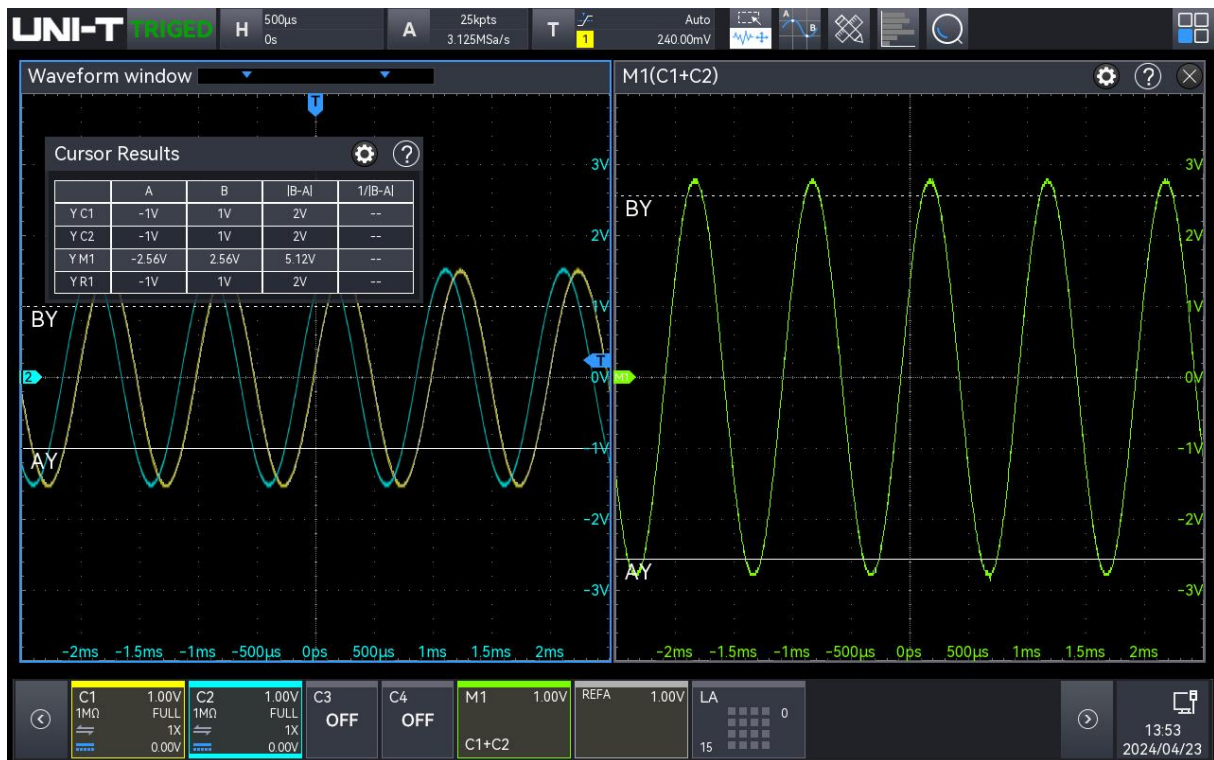

Cursor results info box in top left corner: “Y” represents the results of channel voltage measurement. Math wave supports split screen display, so when the cursor is measuring Math wave, it can also be displayed in split screen, allowing the cursor of each Math channel to be adjusted individually without affecting each other.

The position of AY and BY cursor can be set by the following methods.

- Use the Multipurpose rotary knob to move the cursor, clockwise: move up; anticlockwise: move down. Press the Multipurpose rotary knob to switch between AY and BY.
- Tap to select AY or BY, and drag the cursor to move to the right position, for the use of drag gesture, refer to the section of [Touch Screen](#).

12.3. Screen Measurement

The screen measurement support to set the time cursor and voltage cursor, i.e. the time and voltage measurement can be performed at the same time.

In the “Cursor” menu to switch on the cursor, and click on the “Type” to select “Screen” and then tick on the “Source” to be tested, as shown in the following figure.

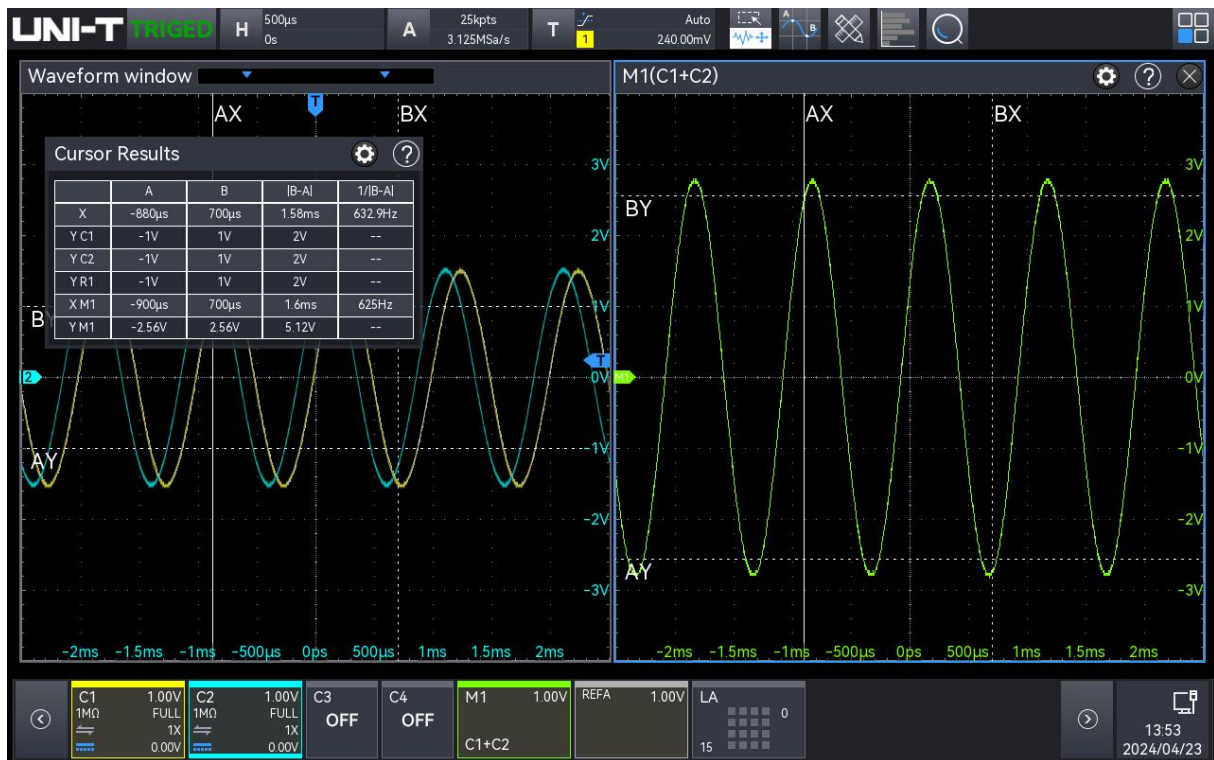

Cursor results info box in top left corner: “X” represents the results of channel time measurement, “Y” represents the results of voltage measurement.

Math wave supports split screen display, so when the cursor is measuring Math wave, it can also be displayed in split screen, allowing the cursor of each Math channel to be adjusted individually without affecting each other.

The position of AX, BX, AY and BY cursor can be set by the following methods.

- Use the Multipurpose rotary knob to move the cursor, clockwise: move to right (move up); anticlockwise: move to left (move down). Press the Multipurpose rotary knob to switch between AX, BX, AY and BY.
- Tap to select AX or BX, and drag the cursor to move to the right position, for the use of drag gesture, refer to the section of [Touch Screen](#).

13. Sampling System

- [Sampling Rate](#)
- [Acquisition Mode](#)
- [Storage Depth](#)
- [Interpolation](#)

Sampling is the conversion of the signal from an analog input channel, through an analog-to-digital converter (ADC), into a discrete point.

The sampling setting menu can be entered by the following steps.

- Press the **Acquire** key on the front panel to enter the “Sampling” setting menu.
- Click on the A sampling info label on the top of the screen (as shown in the following figure) to enter the “Sampling” setting menu.

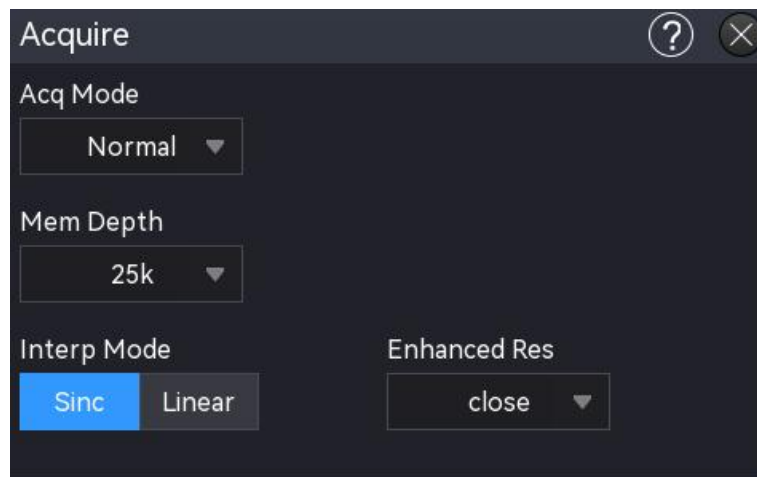

13.1. Sampling Rate

(1) Sampling and sampling rate

Sampling indicates that the oscilloscope is take a sample from the input analog signal and convert the sample to digital data, and then gathering the digital data to waveform records. The waveform records will save in the storage memory.

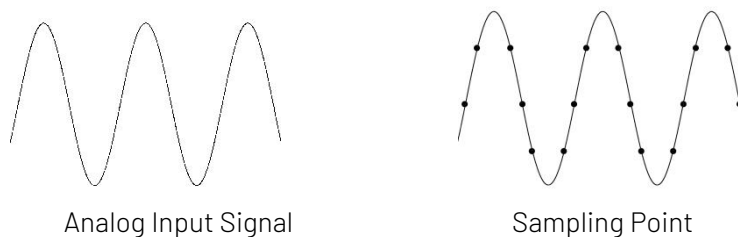

Sampling rate indicates the time interval between two sampling points. The maximum sampling rate of MSO2000X/3000X series mixed signal oscilloscope is 5 GSa/s.

The sampling rate will change with the time base scale and storage depth. The real-time sampling rate is displayed in the A sampling label on the top of the screen, the horizontal time base can be adjusted by using the horizontal Scale or change the “storage depth”.

(2) Effect of low sampling rate

- **Waveform distortion:** Due to low sampling rate, the details of the waveform might be missing, the sampled waveform might have large different than the actual signal, as shown in the following figure.

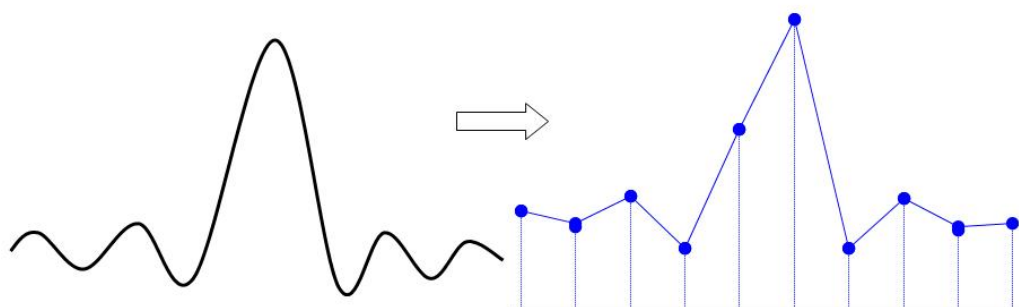

- **Waveform Aliasing:** Since the sampling rate is 2 times lower than the actual signal frequency (Nyquist frequency), the waveform frequency is less than the frequency of actual signal when sampling data is reconstructing, as shown in the following figure.

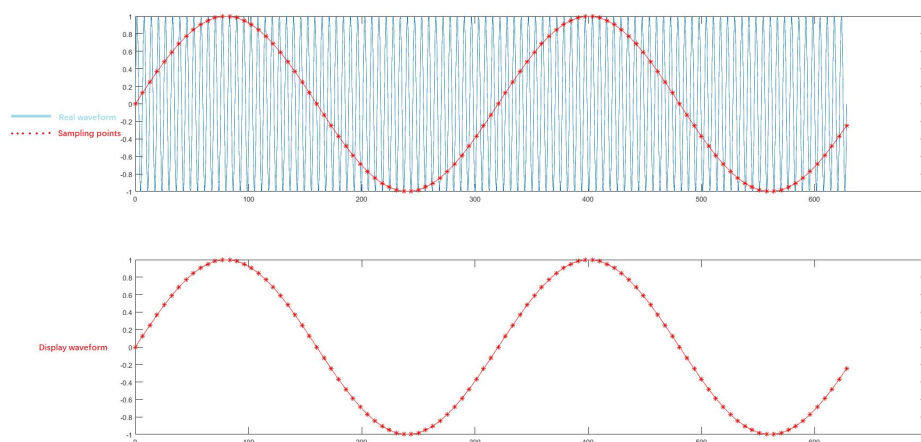

- **Waveform missing:** Due to the low sampling rate, the waveform does not reflect all the actual signals, as shown in the following figure.

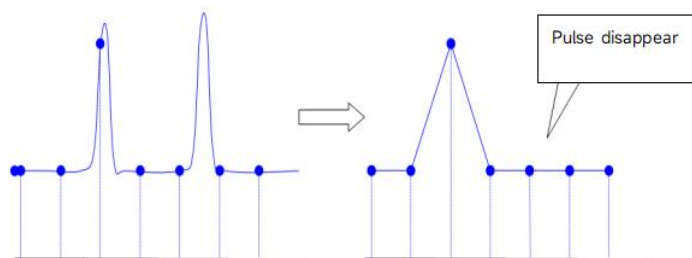

13.2. Acquisition Mode

The acquisition mode controls how the oscilloscope uses the sampling rate to create a waveform. In the “Sampling” menu, click on the “Acquisition mode” to select the mode.

(1) Normal sampling

The oscilloscope samples the signal and reconstruct the waveform with equal time interval in normal mode. For the most of waveform, this mode can produce the optimal display effect.

(2) Peak sampling

The oscilloscope finds the maximum and minimum of the input signal from every sampling interval and using these value to display the waveform. Thus, the oscilloscope can get and display the narrow pulse, otherwise, these narrow pulse will be missed in normal sampling. In this mode, the noise will also look larger.

(3) High resolution

The oscilloscope averages the adjacent point of sampling waveform, it can reduce the random noise of input signal and generate a smoother waveform on the screen.

(4) Average

The oscilloscope obtains several waveforms and calculate its averaged value, and then display the final waveform. This mode can reduce the random noise.

To observe the waveform by changing the acquisition method. If the signal contains large noise, the waveform does not averaged and the waveform adopts 32 times averaged as shown in the following figure. The higher the average value, the lower the noise and the vertical resolution will be much higher, but the change in the waveform will also be slower.

The “average number” is enabled when the acquisition mode is average, and the range can be set to 2~8192, each increment is a power function of 2. The default averaging number of the oscilloscope is 2.

By changing the acquisition mode setting to observe the waveform changes. If the signal contains large noise, when the average mode is not adopted and when the 32 times average mode is adopted, the sampled waveform is shown in the following figure.

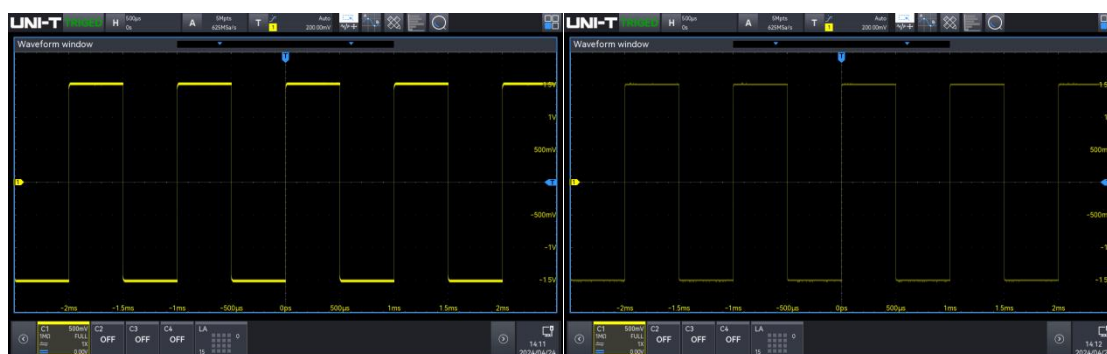

Not Averaged Waveform

Waveform of 32 Times Averaged

Note: Average and high resolution uses different average methods. The former is “multiple sampling averaged”, the latter is “single sampling averaged”.

(5) Sequential acquisition

Sequential acquisition divides the waveform memory of the oscilloscope into multiple segments and records one trigger frame per segment, which can be divided into a maximum of 200,000 segments according to different sampling rates and storage depths. There is a very high probability of capturing abnormal signals (up to 2,000,000 wfms/s) in an acquisition cycle, as signal processing and waveform drawing are reduced, and only the segments are recorded. After recording, the recorded waveforms during the current acquisition cycle can be analyzed and displayed in various ways, i.e. all frames overlay, specified frames overlay and single frame playback, and the waveform data can also be exported.

13.3. Storage Depth

The storage depth is the number of waveform that can be stored in the oscilloscope during a trigger acquisition. It reflects the memory storage capacity of the memorizer.

The relation of the storage depth, sampling rate and sampling time:

$$\text{Storage depth} = \text{sampling rate (Sa/s)} \times \text{sampling time (s/div} \times \text{div)}$$

In the “Sampling” menu, click on the “storage depth” to select the storage depth. The real-time storage depth is displayed in the A sampling label on the top of the screen.

MSO2000X/3000X supported storage depth is shown in the table below:

Models	storage depth
MSO2000X series	Auto(Limit to 10 Mpts), 25 kpts, 250 kpts, 500 kpts, 5 Mpts, 50 Mpts, 100 Mpts
MSO3000X series	Auto(Limit to 10 Mpts), 25 kpts, 250 kpts, 500 kpts, 5 Mpts, 50 Mpts, 100 Mpts, MAX(500 Mpts)

13.4. Interpolation

With real-time sampling, the oscilloscope acquires discrete samples of the displayed waveform. In general, waveforms displayed by dots are difficult to observe. The digital oscilloscope usually uses interpolation to improve the visualization of the signal. The interpolation is a method of “connect each sampling point” and using some points to calculate the waveform. With real-time sampling using interpolation, even if the oscilloscope only captures a small number of sampling points in a single pass, interpolation can be used to fill in the gaps between points and reconstruct an accurate waveform.

The interpolation is divided into sine interpolation (sinc/x) and linear interpolation.

Linear interpolation: Straight lines are directly connected at adjacent sampling points. This method is limited to the reconstruction of pure edge signals, such as square waves.

Sine interpolation (sinc/x): Use a curve to connect the sampling points, this is more common.

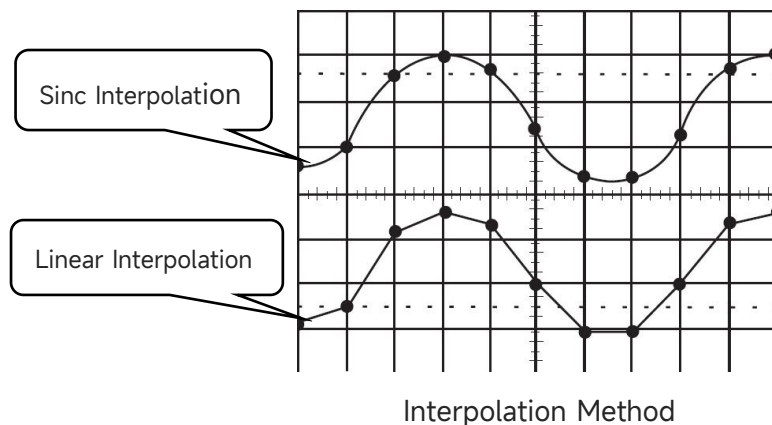

Sinc interpolation uses mathematical processing to calculate the result in the actual sampling point interval. This method bends the signal waveform to produce a more realistic common shape than pure square waves and pulses. When the sampling rate is 3 to 5 times the system bandwidth. Sine interpolation is recommended. The figure below shows a very different display using the two interpolation methods.



14. Display System

In the “Display” menu, set the waveform type, persistence, grid type, waveform brightness, backlight brightness and window transparency.

The “Display” menu can be entered by the following steps.

- Press the **Display** key on the front panel to enter the display menu.
- Click the Home icon  on the top right corner, and select the display icon  to switch on the display menu.
- If the display function is added to the toolbar, click the display icon  in the toolbar on the top right corner to enter the display menu.

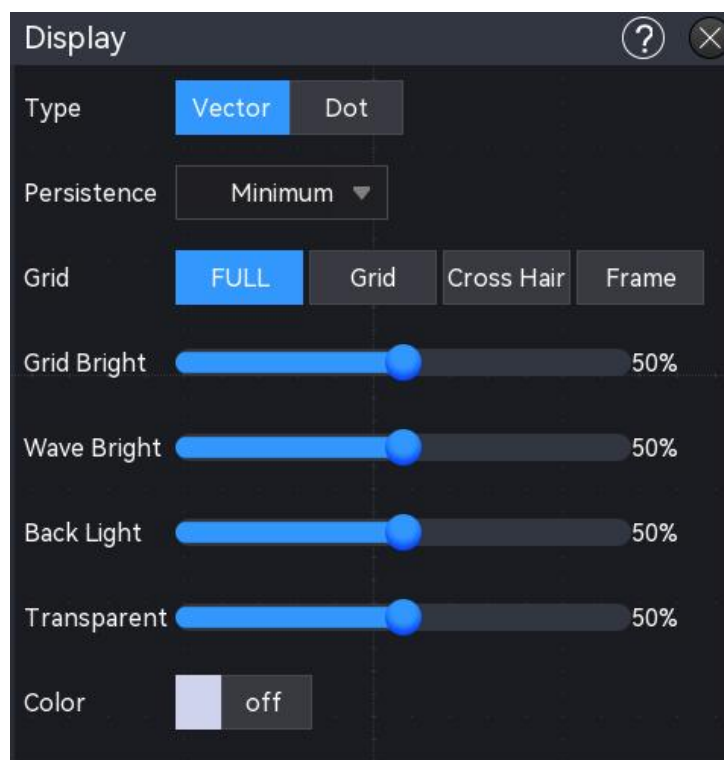

14.1. Display Type

- Vector: The sampling points are shown in the connecting line. This mode provides the most realistic waveform in most cases and makes it easy to view the steep edges of the waveform (e.g. square wave).
- Point: Directly display the sampling point

14.2. Persistence

Set the persistence in the “Display” menu, once the persistence is enabled, the oscilloscope uses the new acquired waveform to refresh the display. but will not immediately delete the old acquired

waveform. The old acquired waveform is displayed with the low brightness color, and the new acquired waveform is displayed with the normal color and brightness.

The persistence can set to minimum, 50 ms, 100 ms, 200 ms, 500 ms, 1 s, 2 s, 5 s, 10 s, 20 s, infinite and off. The default is minimum.

- Minimum: observe the waveform with high refresh
- Adjustable persistence (50 ms...10 s, 20 s): In different persistence, the oscilloscope updates the display with the newly acquired waveforms, and the acquired waveforms are cleared after the appropriate time. Glitch with slower changes or lower probability of occurrence can be observed.
- Infinite: Once "Infinite" is selected, the oscilloscope never clears the acquired waveform. Use infinite persistence to measure noise and jitter, and to capture episodic events.

14.3. Grid Type

- Grid: display a grid with 8 rows and 14 columns
- Full scale: display in crosshair and grid
- Frame: no crosshair, no grid display
- Crosshair: divide the screen to 4 parts

14.4. Grid Brightness

In the "Display" menu, rotate the Multipurpose rotary knob or drag the scroll bar to set the grid brightness.

The brightness range: 0% ~ 100%, the default is 50%.

14.5. Waveform Brightness

In the "Display" menu, rotate the Multipurpose rotary knob or drag the scroll bar to set the waveform brightness.

The brightness range: 1% ~ 100%, the default is 50%.

14.6. Backlight Brightness

In the "Display" menu, rotate the Multipurpose rotary knob or drag the scroll bar to set the backlight brightness.

The brightness range: 1% ~ 100%, the default is 50%.

14.7. Window Transparency

Set the window transparency for all pop-up info box (e.g. Cursor menu, Waveform view menu, etc.), set to the appropriate value for a better view of the measured data. Rotate the Multipurpose rotary knob or drag the scroll bar to set the window transparency

The brightness range: 0% ~ 100%, 0% represents non-transparent, 100% represents fully transparent, and the default is 50%.

14.8. Color Temperature

Switch on/off “color temperature” in the “Display” menu, the default setting is OFF.

Once the color temperature is displayed, the different color represents the number of data acquired or the probability on the screen.

15. Storage and Load



- [Save Menu](#)
- [Waveform Save](#)
- [Save Setting](#)
- [Picture Save](#)
- [Load Setting](#)
- [File Browser](#)

Users can save the current oscilloscope settings, waveforms, screen images and parameters in various formats to internal memory or external USB storage devices (e.g. USB) and reload the saved settings or waveforms as required. It is also possible to load the updated version of the software into the system to upgrade the instrument. In addition, the user can copy, delete and rename files of specified types in the internal memory or external USB memory using the Disk manager menu. This oscilloscope has 3 USB HOST ports (1 on the front panel, 2 on the rear panel) for external USB storage connection.

Note: This oscilloscope only supports the USB format of FAT32, NTFS and EXFAT.

15.1. Save Menu

The save setting menu can be entered by the following steps.

- Press the **Save** key on the front panel to enter the save setting menu.
- Click the Home icon  on the top right corner, and select the save icon  to enter the save setting menu.
- If the save function is added into the toolbar, click the counter icon  in the toolbar on the top right corner to enter the save setting menu. The save setting menu has two sub-menu "Save" and "Load", please select the sub-menu to set.

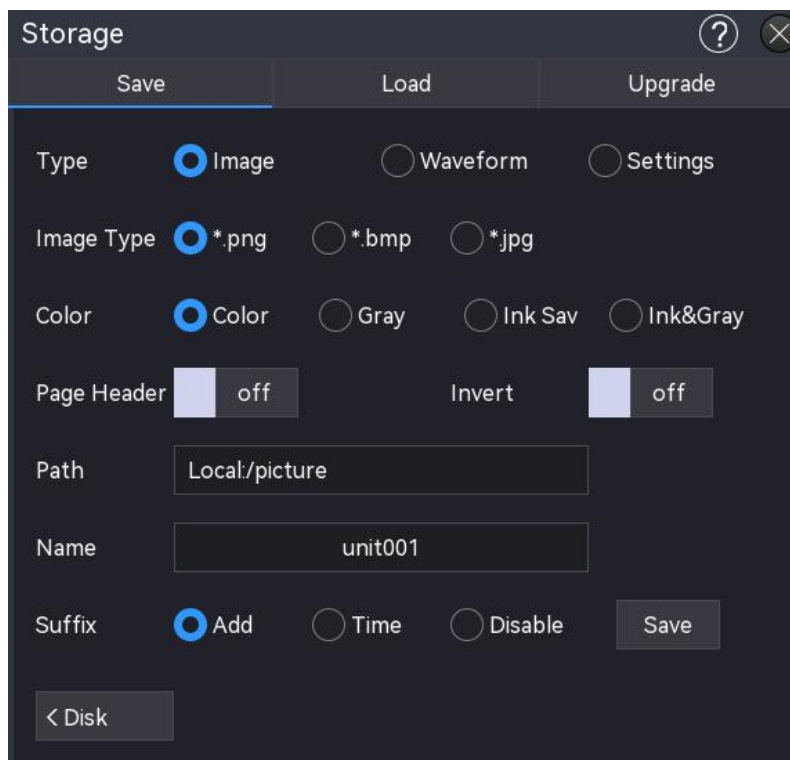

15.2. Waveform Save

Enter the submenu of “Save” to select “Waveform save” to enter the setting menu, the channel that has selected source (vertical scale, horizontal time base) can be saved to internal or external storage.

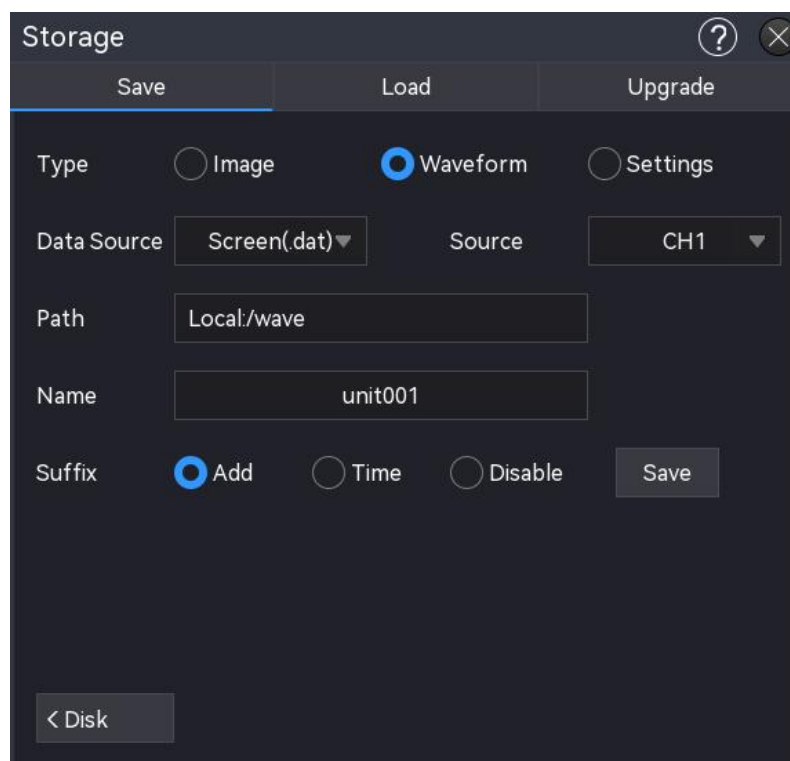

Waveform setting menu: data type, source, save path, filename and suffix.

(1) Data type

Click on the “Data type” to select the data type of the waveform to be saved, it has two kinds type of screen (.dat) and deep memory (.csv).

(2) Source

Click on the “Source” to select the source of waveform to be saved. For waveform data storage, only open sources are supported. The source can select CH1~CH4, Math1~Math4 and Digital.

(3) Save path

Double-click on “Save path” text field to pop up the file browser menu, and select the save directory in the file browser menu, then click “Enter” key to set the save path. For the use of file browser, refer to the section of [File Browser](#). When a USB is not connected, the default save path is the local disk “Local:/wave”. When a USB has detected, “USB:” can be selected as the save path.

(4) Filename

Double-click on the “Filename” text field to pop up the numeric keyboard to set the filename. For details on the use of the numeric keyboard, refer to “Enter character sting” in the section of [5.8 Parameter Setting](#).

(5) Suffix

Tap to select the suffix to “Forbid”, “Time” or “Accumulate”. The filename of picture will be saved with the selected suffix to the internal or external storage.

- Forbid: saved with the filename and not add a suffix
- Time: add the current system time as the suffix for the filename to be saved
- Accumulate: add the accumulated number as the suffix for the filename to be saved, the number starting from 0001 to accumulate.

(6) Disk manager

Click on the “Disk manager” to jump to the file browser, for the use of file browser, refer to the section of [File Browser](#).

(7) Save

Click on the “Save”, the system will save the waveform file according to the current setting and display a saving result hint.

15.3. Save Setting

Enter the submenu of “Save” to select “Save setting” to enter the setting menu, the oscilloscope will save the setting with the format of “.set” to internal or external storage. The saved setting can be loaded as required.

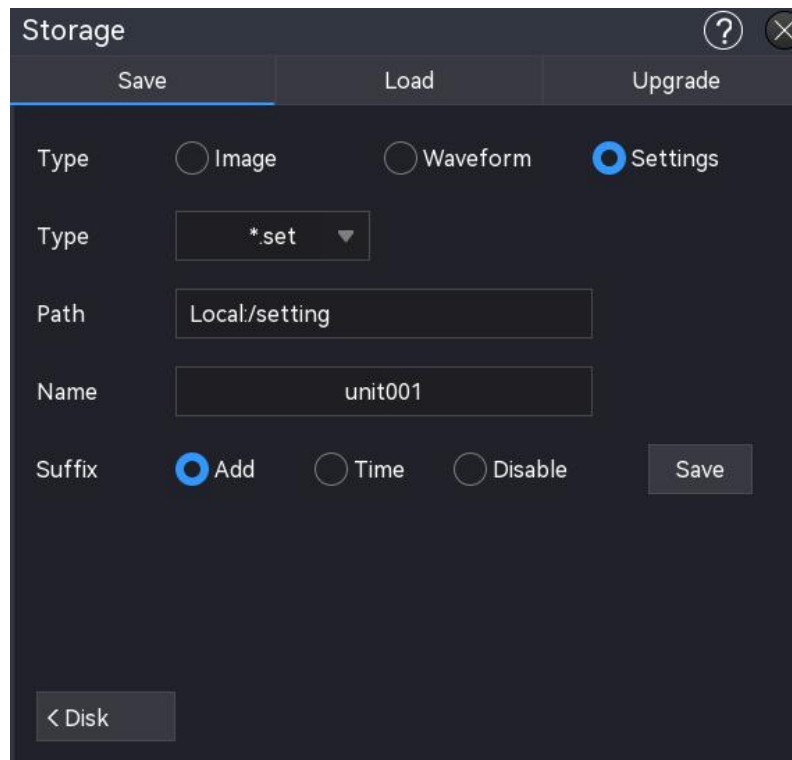

Save setting menu: file type, source, save path, filename and suffix.

(1) File type

Click on the “Data type” to select the data type of waveform to be saved, *.set can be selected.

(2) Save path

Double-click on “Save path” text field to pop up the file browser menu, and select the save directory in the file browser menu, then click “Enter” key to set the save path. For the use of file browser, refer to the section of [File Browser](#). When a USB is not connected, the default save path is the local disk “Local:/wave”. When a USB has detected, “USB:” can be selected as the save path.

(3) Filename

Double-click on the “Filename” text field to pop up the numeric keyboard to set the filename. For details on the use of the numeric keyboard, refer to “Enter character sting” in the section of [5.8 Parameter Setting](#).

(4) Suffix

Tap to select the suffix to “Forbid”, “Time” or “Accumulate”. The filename of picture will be saved with the selected suffix to the internal or external storage.

- Forbid: saved with the filename and not add a suffix
- Time: add the current system time as the suffix for the filename to be saved
- Accumulate: add the accumulated number as the suffix for the filename to be saved, the number starting from 0001 to accumulate.

(5) Disk manager

Click on the “Disk manager” to jump to the file browser, for the use of file browser, refer to the section of [File Browser](#).

(6) Save

Click on the “Save”, the system will save the setting file according to the current setting and display a saving result hint.

15.4. Picture Save

Enter the submenu of “Save” to select “Picture save” to enter the setting menu, the oscilloscope will save the picture according to the setting to internal or external storage.

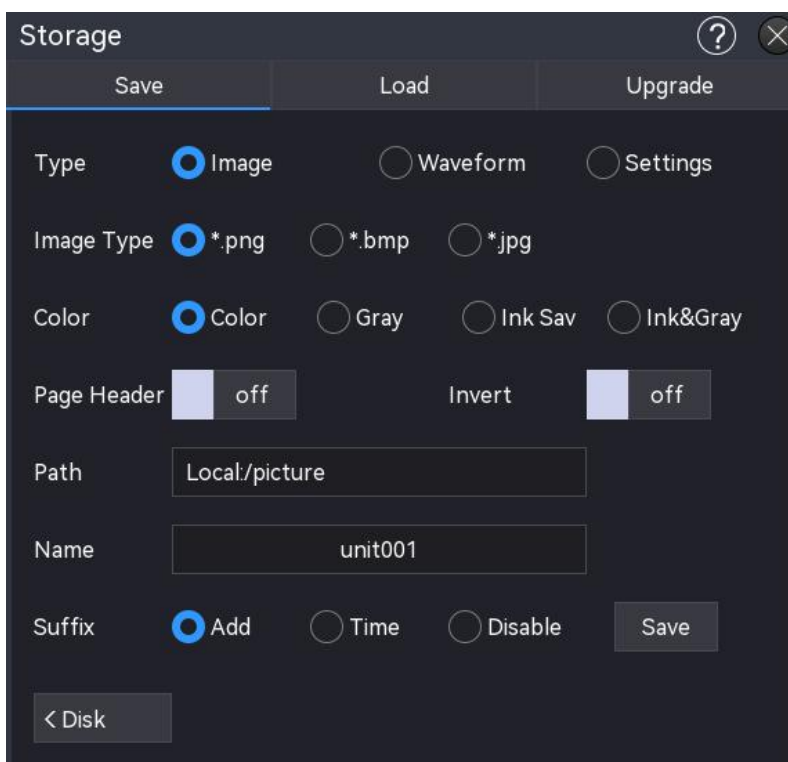

Picture save setting menu: picture type, color, page header, inverse color, save path, filename and suffix.

(1) Picture type

Click on the “Picture type” to select the format to “.png”, “.bmp” or “.jpg”. The screen image will be saved with the selected format to internal or external storage.

(2) Color

Click on the “Color” to select the picture color to be saved.

Color	The oscilloscope’s screenshot will be saved with the displayed color.
Save ink	The oscilloscope’s screenshot will change the dark background to light color and be saved, this is to save ink.
Grey	The oscilloscope’s screenshot will change the color to grey and be

	saved.
Grey & Save ink	The oscilloscope's screenshot will change the dark background to light color, and change the color to grey and be saved.

(3) Page header

Click on the "Page header" to switch on/off the page header.

ON: the instrument model and image data will be displayed in the page header.

OFF: no information is displayed in the page header

(4) Inverse color

Click on the "Inverse color" to switch on/off the inverse color function.

(5) Save path

Double-click on "Save path" text field to pop up the file browser menu, and select the save directory in the file browser menu, then click "Enter" key to set the save path. For the use of file browser, refer to the section of File Browser. When a USB is not connected, the default save path is the local disk "Local:/wave". When a USB has detected, "UDISK: " can be selected as the save path.

(6) Filename

Double-click on the "Filename" text field to pop up the numeric keyboard to set the filename. For details on the use of the numeric keyboard, refer to "Enter character sting" in the section of 5.8 Parameter Setting.

(7) Suffix

Tap to select the suffix to "Forbid", "Time" or "Accumulate". The filename of picture will be saved with the selected suffix to the internal or external storage.

- Forbid: saved with the filename and not add a suffix
- Time: add the current system time as the suffix for the filename to be saved
- Accumulate: add the accumulated number as the suffix for the filename to be saved, the number starting from 0001 to accumulate.

(8) Disk manager

Click on the "Disk manager" to jump to the file browser, for the use of file browser, refer to the section of [File Browser](#).

(9) Save

Click on the "Save", the system will save the picture file according to the current setting and display a saving result hint.

15.5. Load Setting

Enter the submenu of “Save” to select “Load setting” to enter the setting menu, to load the saved setting file to the oscilloscope.

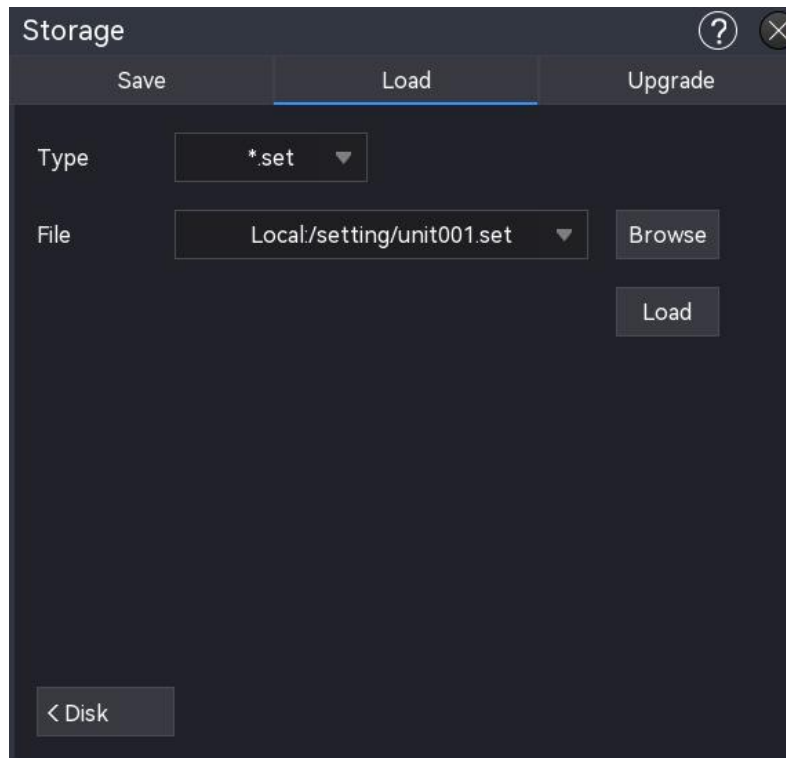

Load setting: file type, setting file

(1) File type

Select the type of loading setting file, the default type is “.set”, and cannot be changed.

(2) Setting file

Click on the “Browse” to enter the file browser and select the setting file to be loaded. For the use of file browser, refer to the section of [File Browser](#).

(3) Load

Click on the “Load” to load the selected setting file.

(4) Disk manager

Click on the “Disk manager” to jump to the file browser, for the use of file browser, refer to the section of [File Browser](#).

15.6. File Browser

Enter the “Save” menu and to select “Disk manager” at the bottom left corner to enter the disk manager menu, as shown in the following figure.

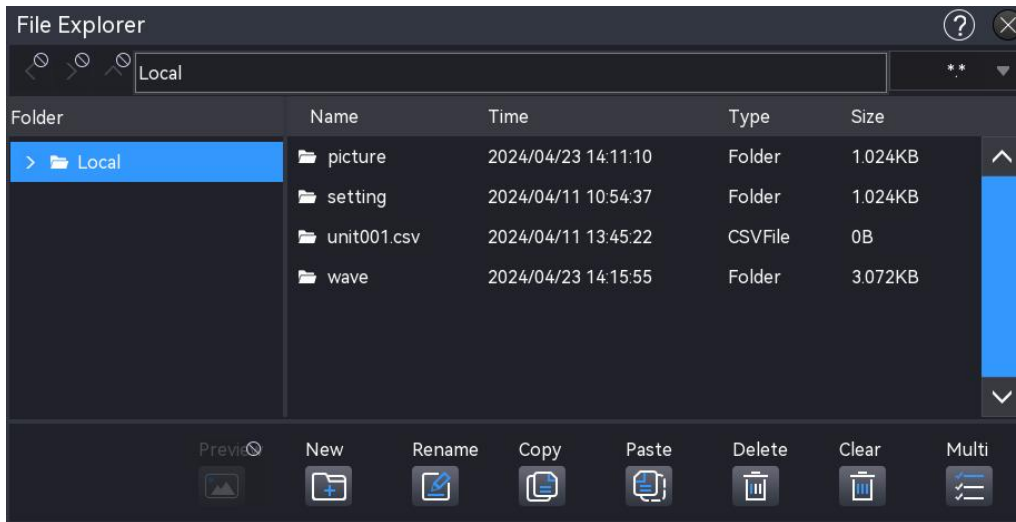

(1) Select Disk

Before connecting an external storage, please make sure that USB (FAT32, Flash) is correctly connected. The save interface displays the contents of Local by default. If an external storage is connected, click the hardware icon in the top left in the “Save” menu to select “Local” or “USB”. If “USB” is selected, the save interface will display the contents of USB.

(2) New file

Click on the icon  to pop up the numeric keyboard to add a new file and enter the new filename. For details on the use of the numeric keyboard, refer to “Enter character string” in the section of [5.8 Parameter Setting](#).

(3) Rename file or directory

Click on the icon  to pop up the numeric keyboard to rename the file or directory.

(4) Copy file to the specified directory

Select the specified file or file folder, click on the copy icon  and enter the specified file folder and then click the paste to complete this setting.

(5) Paste

Select the specified file or file folder, click on the paste icon  to copy the file or file folder to the specified file folder.



(6) Delete

In the current directory, tick on the file or directory to be deleted, and click on the delete icon , and then click on the “Enter” to complete this setting, click on the “Cancel” to cancel this setting.

(7) Delete all

Delete all files and file folders in the current directory. Click on the delete icon  and then click on the “Enter” to complete this setting, click on the “Cancel” to cancel this setting.

(8) Multiple choice

This oscilloscope supports selecting multiple files or file folders at the same time. Click the multiple choice icon , click the check box to the right of the file, and it will be displayed in the selected state  when the selection is complete, and then deselect it by clicking the check box again, and the check box will return to its original state . You can also select all files and directories under the current disc by clicking the check box in the top right corner of the menu. Clicking the check box again will cancel the Select All operation.



(9) Suffix

Click on the "File browser" in the top right corner and select the suffix type, *.*, .png, .bmp, .jpg, .csv, .bsv, .dat or .set, *.* represents all file types.

16. Reference Waveform

During the actual test, the user can compare the signal waveform with the reference waveform to determine the cause of the fault.

The reference waveform can be entered by the following steps.

- Press the **Ref** key on the front panel to enter the reference waveform setting menu.
- Click the Home icon  on the top right corner, and select the reference icon  to enter the reference waveform.
- If the reference waveform is added to the toolbar, click the reference icon  to enter the reference waveform.

This oscilloscope provides 4 reference waveforms (RefA~RefD), the setting of each reference waveform is the same. This chapter describes how to set the reference waveform using RefA as an example.

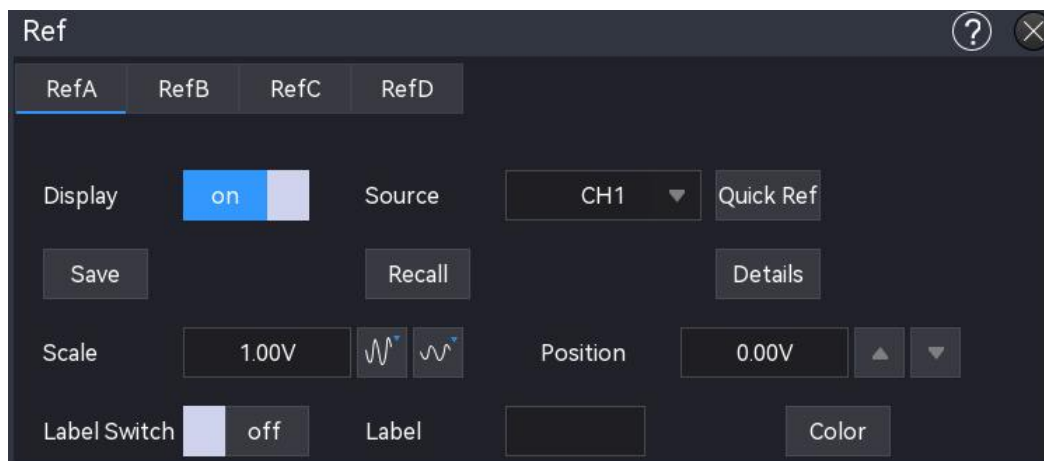

16.1. Display

Click on the “Display” to switch on/off the display of reference waveform.

16.2. Source

Click on the “Source” to select the source of waveform to be saved. Only the opened sources are supported to save waveform data, CH1-CH4 can be selected.

16.3. Save

(1) File path

Double-click on the “File path” text field to pop up the file browser menu, and select the save

catalogue in the file browser menu, then click “Enter” key to set the save path. For the use of file browser, refer to the section of [File Browser](#). When a USB is not connected, the default save path is the local disk “Local:/wave”. When a USB has detected, “USB” can be selected as the save path.

(2) Filename

Double-click on the “Filename” text field to pop up the numeric keyboard to set the filename. For details on the use of the numeric keyboard, refer to “Enter character sting” in the section of [5.8 Parameter Setting](#).

(3) Waveform type

The default waveform type is *.dat, and cannot be changed.

16.4. Load

Click on the “Browse” to pop up the file browser menu, and click the waveform file to be loaded. Click on the “Import” to load the selected waveform file. Tap on the “Import” menu, the recently 5 load file records will be displayed, the record can also be selected to load.

16.5. Quick Reference



Click on the “Quick reference” to load the currently selected source for reference, but will not save the waveform file.dat. The Quick Reference function is only available for the current source, it should be re-selected after deletion.

16.6. Reference Detail

Click on the “Quick reference” to check the reference detail of the current reference waveform, including time base scale, sampling rate, volts/div, amplitude resolution, unit and count.

16.7. Vertical Scale

Set the vertical scale of Ref wave in the display window, it can be set by the following steps.

- In “Ref” menu, click on the “Vertical scale” text field, rotate the Multipurpose rotary knob on the front panel to change the vertical scale.
- Tap the vertical scale icon ,  on the right to increase or decrease the vertical scale.
- Click on the number text field to pop up the numeric keyboard to enter the specified numeric value.

16.8. Vertical Position

Set the vertical offset of Ref wave in the display window, it can be set by the following steps.

- In “Ref” menu, click on the “Vertical position” text field, rotate the Multipurpose rotary knob on the front panel to change the vertical position.
- Tap the arrow key \uparrow , \downarrow on the right of the vertical position to increase or decrease the vertical position.
- Click on the number text field to pop up the numeric keyboard to enter the specified numeric value.

16.9. Label

Click on the “Label” to switch on/off the channel label. The label can be customized, double-click on the “Label” text field to pop up the numeric keyboard to enter the character string.





16.10. Channel Color

Set the color for the Ref waveform and label. Click on the “Channel color” to enter the setting menu.

- Source: Click on the “Source” to select the source to set the color, the source can select M1, M2, M3, M4, R1, R2, R3, R4.
- Color: Tap the color plate and drag to select the color.

17. Utility Function

Set the system function in the “Utility” menu. The utility menu can be entered by the following steps.

- Press the **Utility** key on the front panel to enter the utility setting menu.
- Click the Home icon  on the top right corner, and select the utility icon  to enter the utility setting menu.
- If the utility function is added into the toolbar, click the utility icon  in the toolbar on the top right corner to enter the utility setting menu.

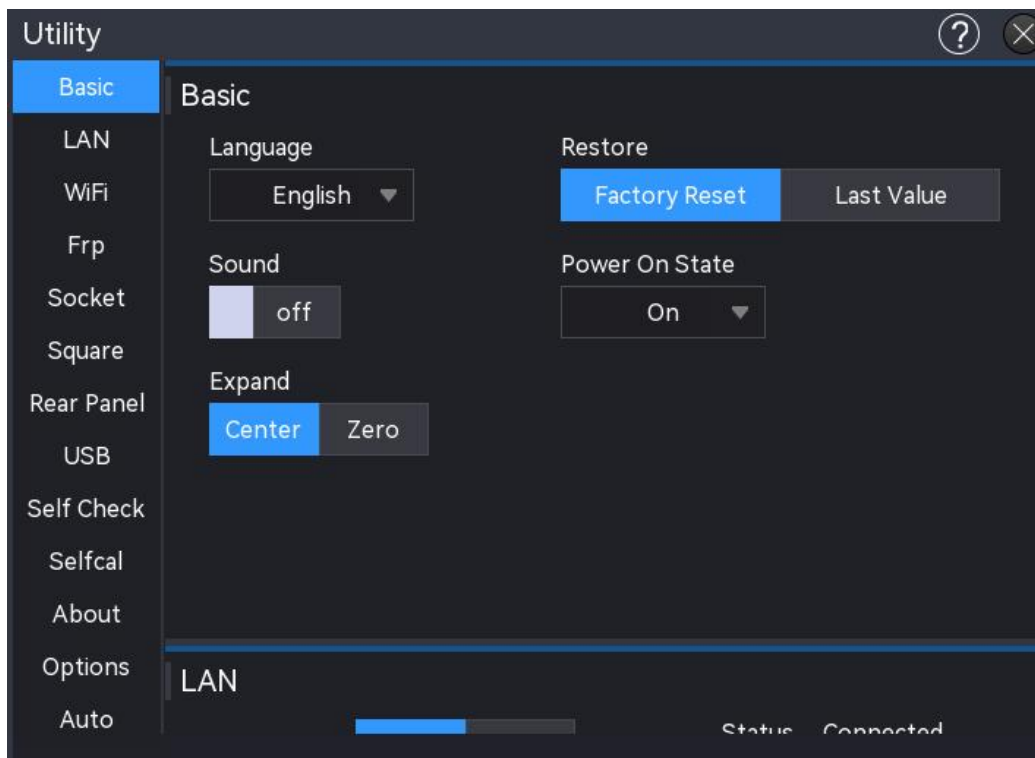

17.1. Basic Information

The basic information includes language, restore setting, sound, power-on state and vertical extension.

(1) Language

Click on the “Language” to set the system language to English, simplified Chinese or traditional Chinese.

(2) Restore setting

The user can select the system configuration to be loaded when the device is re-powered. The system configuration can select “Factory setting” or “Last setting”.

- Last setting: restore the settings from the last time the system was powered down

- Factory setting: restore to the factory setting

(3) Sound

Click on the “Sound” to switch on/off the beep. When the sound is on, a buzzer sounds when the following operations or actions are performed.

- Press the key on the front panel or menu key
- Use the touch screen function
- Prompt a message

(4) Power-on state

Set the power-on mode of the oscilloscope, it can set always off, always on and last status.上

- Always off: When the power switch on the rear panel is turned on, the oscilloscope can only be opened by manually pressing the power softkey on the front panel.
- Always on: The oscilloscope can be opened directly when the power switch on the rear panel is switched on.
- Last status: When the rear panel power switch is switched on, the oscilloscope restarts according to the last shutdown state; if the last shutdown was via the power softkey, the oscilloscope should switch on via the power softkey; if the last shutdown was via direct power down, the oscilloscope can be opened directly.

(5) Vertical extension

Click the vertical extension for the waveform.

- Screen center: When changing the vertical scale, the waveform will be extended or compressed around the screen center.
- Channel's zero position: When changing the vertical scale, the waveform will be extended or compressed around the channel's zero position.

17.2. Network Setting

When the device is connected with available internet, IP setting is used to set the IP, subnet mask , gateway of the oscilloscope and DNS address.

(1) Mode

Switch IP acquire mode, it can set manual or auto (DHCP).

- Manual: Set IP address, subnet mask, gateway address and DNS address by manual.
- Auto(DHCP): Only for checking IP address, subnet mask, gateway address and DNS address.

- a. IP Address: IP address format is nnn.nnn.nnn.nnn, the first nnn range is from 1 to 233, and the second nnn range is from 0 to 255. It is recommended that user can consult network

administrator for an available IP address.

- b. Subnet mask: The format is nnn.nnn.nnn.nnn, the nnn range is from 0 to 255. It is recommended that user can consult network administrator for an available subnet mask.
- c. Gateway address: The format is nnn.nnn.nnn.nnn, the first nnn range is from 1 to 255, and the second nnn range is from 0 to 255. It is recommended that user can consult network administrator for an available gateway address.
- d. DNS address: The format is nnn.nnn.nnn.nnn, the first nnn range is from 1 to 255, and the second nnn range is from 0 to 255. It is recommended that user can consult network administrator for an available DNS address.

(2) Apply

After manually editing the IP address, subnet mask, gateway address and DNS address information, click on the "Apply" to complete the setting.

(3) LAN Reset

If you want to clear the IP address, subnet mask, gateway address and DNS address, click on the "LAN Reset" to clear the edited IP address, subnet mask, gateway address and DNS address.

17.3. WiFi Setting

WiFi only MSO3000X series support.

When the device is connected with available internet, IP setting is used to set the IP, subnet mask , gateway of the oscilloscope and DNS address.

(1) Mode

Switch IP acquire mode, it can set manual or auto (DHCP).

- Manual: Set IP address, subnet mask, gateway address and DNS address by manual.
 - Auto(DHCP): Only for checking IP address, subnet mask, gateway address and DNS address.
- a. IP Address: IP address format is nnn.nnn.nnn.nnn, the first nnn range is from 1 to 233, and the second nnn range is from 0 to 255. It is recommended that user can consult network administrator for an available IP address.
 - b. Subnet mask: The format is nnn.nnn.nnn.nnn, the nnn range is from 0 to 255. It is recommended that user can consult network administrator for an available subnet mask.
 - c. Gateway address: The format is nnn.nnn.nnn.nnn, the first nnn range is from 1 to 255, and the second nnn range is from 0 to 255. It is recommended that user can consult network administrator for an available gateway address.
 - d. DNS address: The format is nnn.nnn.nnn.nnn, the first nnn range is from 1 to 255, and the

second nnn range is from 0 to 255. It is recommended that user can consult network administrator for an available DNS address.

(2) Apply

After manually editing the IP address, subnet mask, gateway address and DNS address information, click on the "Apply" to complete the setting.

(3) LAN Reset

If you want to clear the IP address, subnet mask, gateway address and DNS address, click on the "LAN Reset" to clear the edited IP address, subnet mask, gateway address and DNS address.

17.4. Square Selection

This oscilloscope has two square output ports, port 1 and port 2 are corresponding to the robe Comp1 and Probe Comp2 on the front panel. The square output frequency can be set to 10 Hz, 100 Hz, 1 kHz, 10 kHz or 100 kHz. The default is 10 kHz.

17.5. Rear Panel

In the auxiliary menu, click on the "Rear panel" or drag the content to enter the rear panel setting.

(1) 10 MHz sync

- Idle: The [10MHz REF In&Out] connector on the rear panel is not used as an input or output port for the reference clock.
- Input: The [10MHz REF In&Out] connector on the rear panel is used as an input port for the reference clock.
- Output: The [10MHz REF In&Out] connector on the rear panel is used as an output port for the reference clock.

(2) AUX output

AUX output is used to select the output signal for the [AUX Out] connector on the rear panel.

- Output: Every time the oscilloscope generates a trigger, a signal reflecting the current capture signal of the oscilloscope is output from the [AUX Out] connector on the rear panel. When this signal is connected to the waveform display and device and measure the frequency of this signal, the measured result is the same as the current capture signal.
- Pass/Fail: In a pass/fail test, a positive or negative pulse is output from the rear panel [AUX Out] connector when the oscilloscope detects a pass or fail event.

17.6. Self-inspection

(1) Keyboard self-inspection

Keypad detection is mainly used to detect when the front panel keys or knob of the oscilloscope are not responding or are not responding sensitively. Press the self-inspection key, the oscilloscope will enter the following figure.

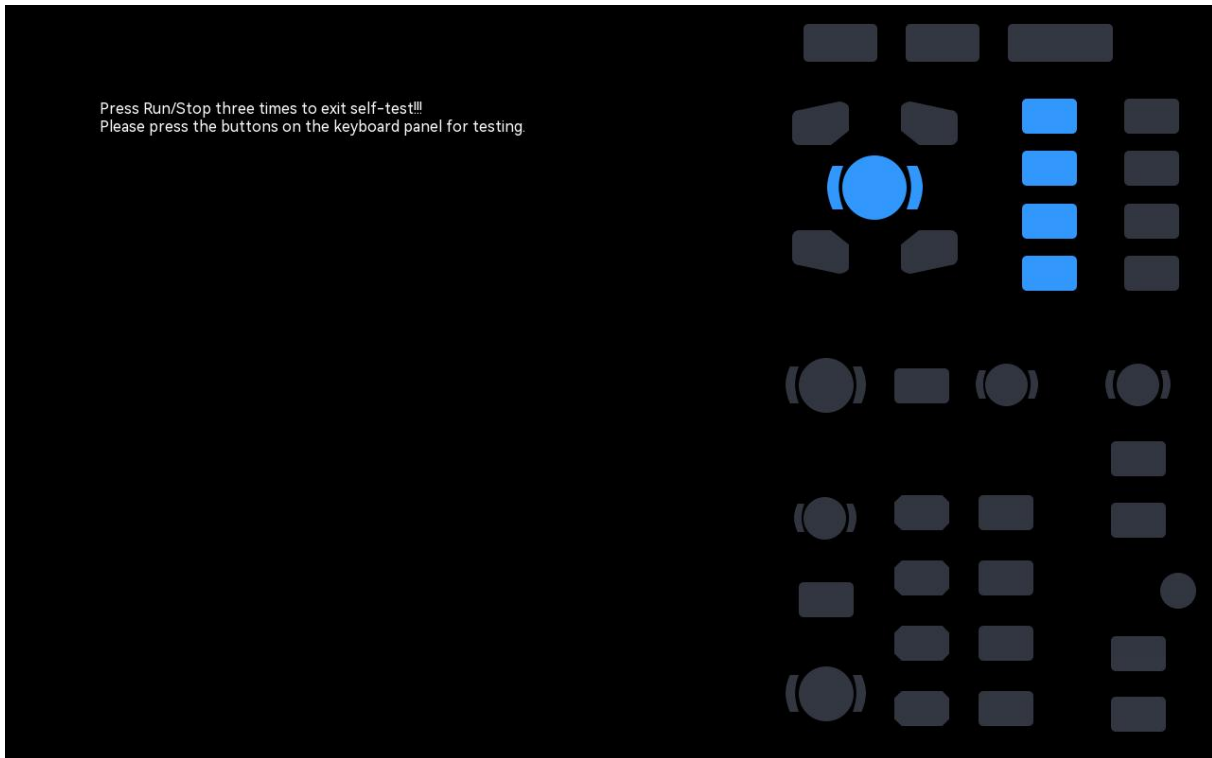

Rotary knob test: Rotate and press each rotary knob from up to down, left to right, observing the rotary whether the rotary knob indicator is lit on the display interface.

Key test: Rotate and press each key from up to down, left to right, observing the rotary whether the key indicator is lit in real time on the display interface.

When all rotary knobs and keys have been tested, press the "Run/Stop" keys three times to exit the keyboard test in accordance with the on-screen instructions.

(2) LED detection

LED detection is mainly used to check whether the key indicator on the front of the oscilloscope can be lit or not, and whether the brightness is poor. When the LED test is pressed, the oscilloscope enters the interface is shown in the following figure.

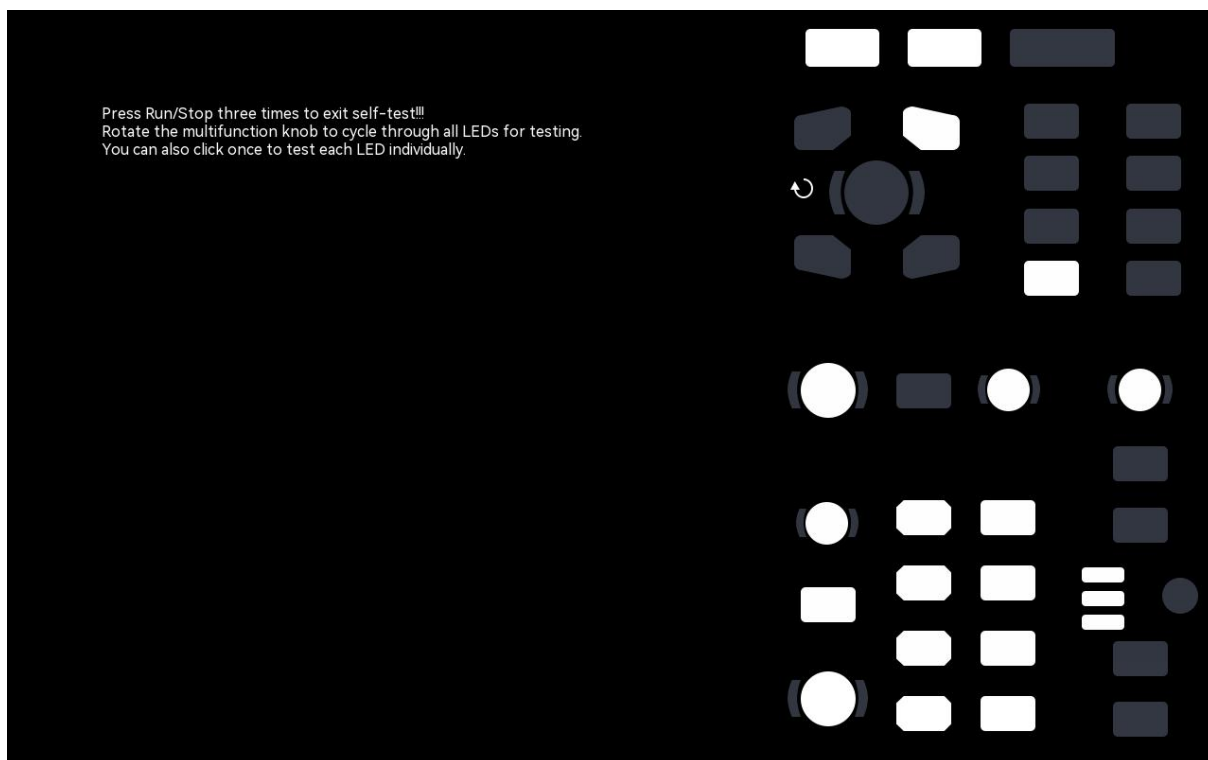

Rotary knob test: Enter the LED test, rotate the Multipurpose rotary knob, the first LED on the front panel is light and the corresponding position of the key will be illuminated on the screen, continue rotating the Multipurpose rotary knob to switch to the next LED. Using this method to detect all the key indicators one by one, observing whether all indicators on the front panel are illuminated.

Key test: Touch the white key on the screen, observing whether LED is lit in real time on the front panel.

When all rotary knobs and keys have been tested, press the "Run/Stop" keys three times to exit LED test in accordance with the on-screen instructions.

(3) Touch screen detection

Touch screen detection is mainly used to check whether the touch screen is invalid or not responding in time. Press the touch screen detection, the oscilloscope enters the interface is shown in the following figure.

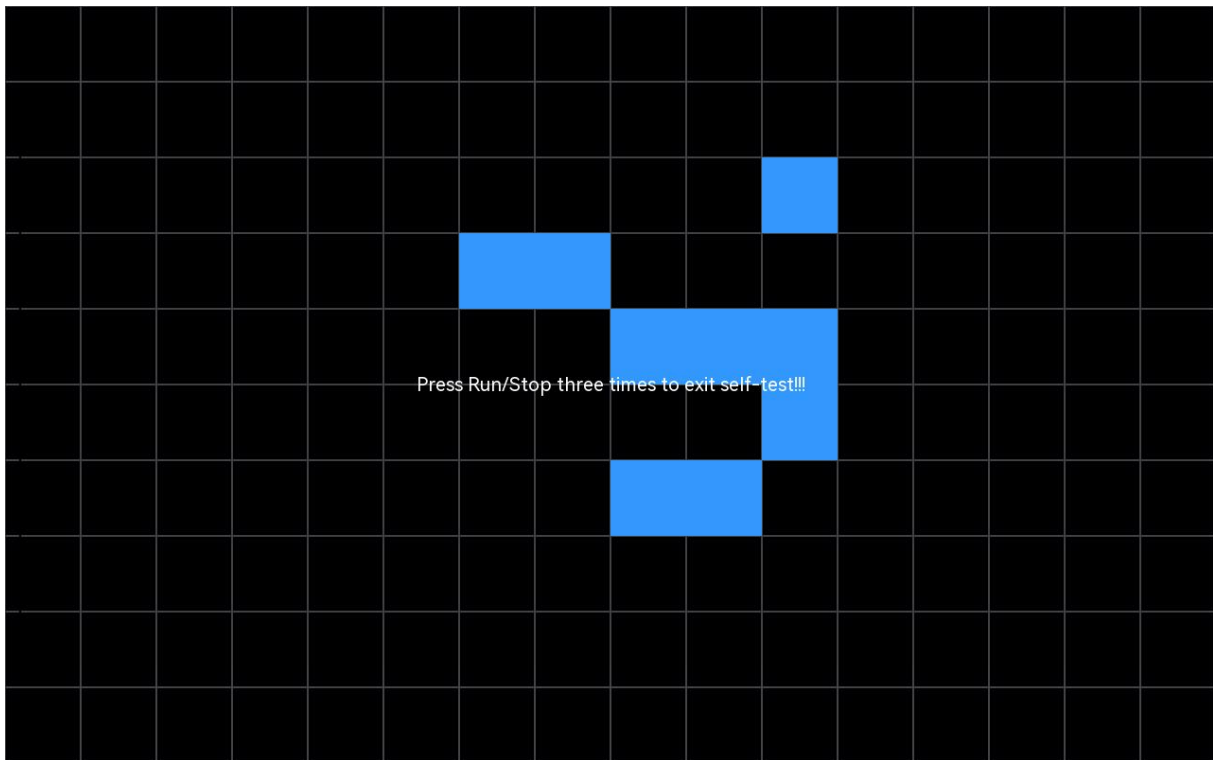

Touch each grid on the touch screen to observe if the grid turns blue.

When all rotary knobs and keys have been tested, press the "Run/Stop" keys three times to exit the touch screen test in accordance with the on-screen instructions.

(4) Screen detection

Screen detection is used to check whether the oscilloscope screen has color offset, bad dots or screen scratches. Press the screen detection, the oscilloscope enters the interface is shown in the following figure. The interface displays pure red.

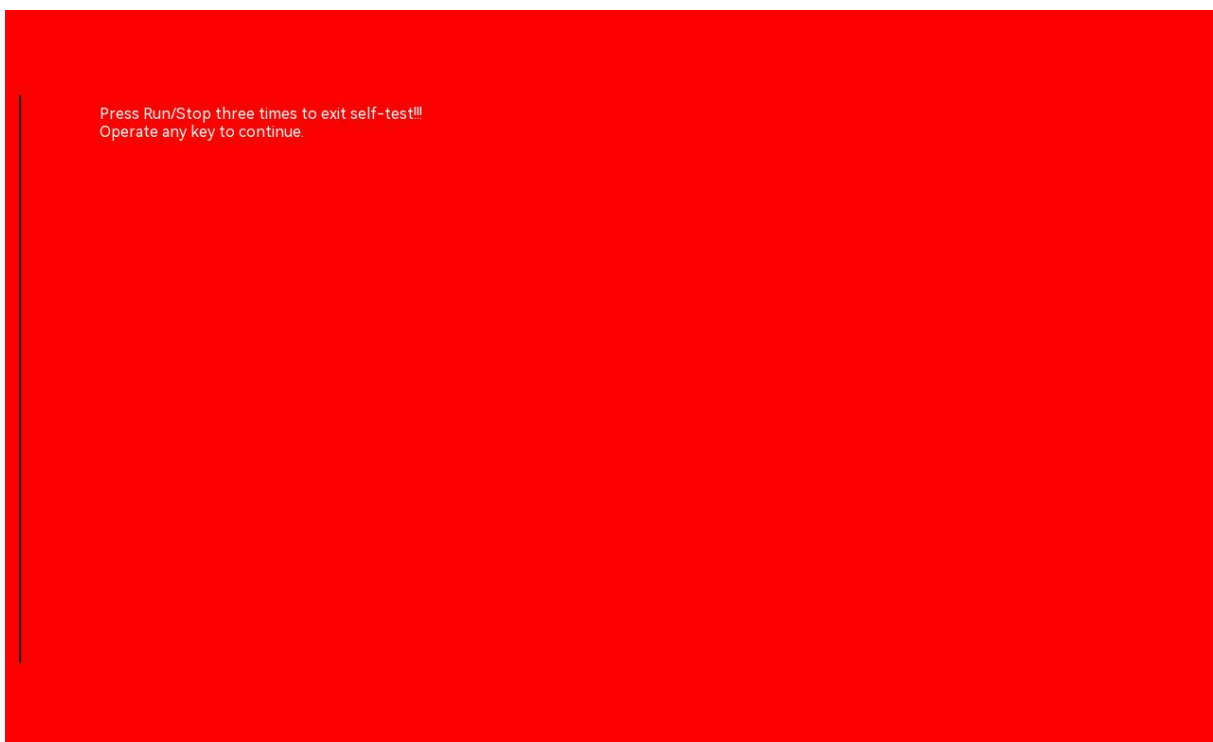

Press any key to switch to the red, green, blue, black and white according to the on-screen instruction. Observe the screen under the appropriate surface of each color to see if there are any serious problems such as color differences, stains or scratches.

When the color test has been tested, press the "Run/Stop" keys three times to exit the touch screen test in accordance with the on-screen instructions.

17.7. Auto-calibration

The auto-calibration function allows the oscilloscope to reach the optimum working condition for the most accurate measurement. The auto-calibration function is divided into analog channel calibration and Digital calibration. This function can be performed at any time, especially when the ambient temperature range varies within 5°C or more. Before performing the auto-calibration operation, please make sure that the oscilloscope has been turned on and running for more than 20 minutes.

- (1) Analog channel calibration: the calibration is only for analog channel and the calibration time is 3 ~ 5 mins.
- (2) Digital calibration: the calibration is for digital channel and the calibration time is 3 ~ 5 mins.

17.8. About Oscilloscope

Click on "About" in the auxiliary menu to check the oscilloscope information.

- Model
- Serial number: the unique identification
- Firmware version
- Hardware version
- Installed module
- Installed certificate

17.9. Option

Click on the "Option" in the auxiliary menu to check all options.

Select any one of the option to enable it or click on the "All activate" to enable all the options, as shown in the following figure.

All options support 145 hours trial period. After the trial period is over, users need to purchase the option and get the option license, stored in the USB and then plugged into the device, this option can be activated under the module. MSO2000X/3000X supports the option function include: CAN,

CAN-FD, LIN, FlexRay, SNET , I2S, 1553B, Manchester, ARINC429, BODE, Digital.

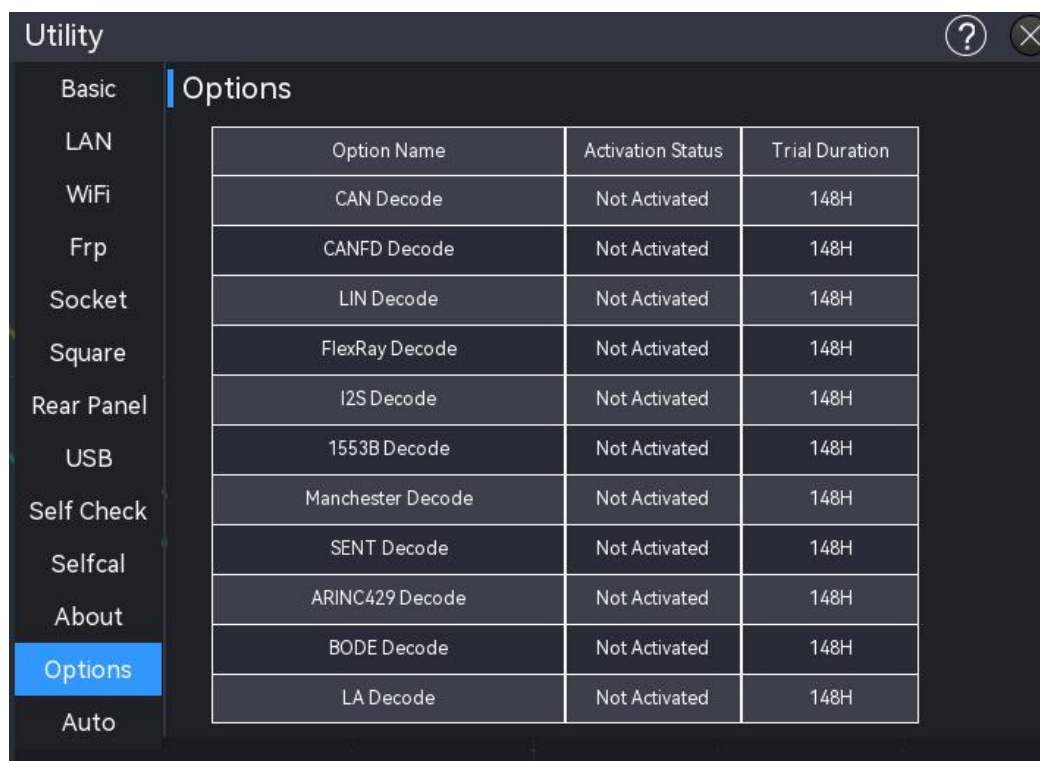

17.10. Auto Setting

Click on the “Auto setting” in the auxiliary menu to enter the setting.

(1) Channel setting

- In hold mode, the bandwidth limit, reversed phase, impedance, unit, probe multiplying ratio, label state remain the same, and coupling (ground), volts/div, offset and fine-tuning are reset to the default.
- In auto mode, the impedance, unit, probe multiplying ratio, label state remain the same, other settings are reset to the default.

(2) Acquisition setting

- In hold mode, all settings remain the same.
- In auto mode, the acquisition mode reset to the default, other settings are remain the same.

(3) Trigger source

- In hold mode, the source, trigger coupling remain the same, and other settings are reset to “edge trigger, auto, rising edge”.
- In auto mode, all parameters are reset to the default.

(4) Activate channel

- In hold mode, the switch state remains the same when the channel is automatically set.
- In auto mode, only open channels with signal input.

18. System Upgrade

This series can use USB to update program. It's convenient and flexible.

USB update has two methods. Method 1: Turn on the oscilloscope to detect USB update; Method 2: Utility-update-detect the update file in USB and select the file to update.

Enter the submenu "Upgrade" in the auxiliary menu to access the upgrade menu. The oscilloscope supports three types of upgrade methods: local upgrade and online upgrade. The specific steps are as follows.

(1) Boot-up upgrade

- ① Press **Utility** key to enter the auxiliary function menu, click on the "About" to check the system information: model name, software and hardware version.
- ② Download the update file from UNI-T official website or ask UNI-T distributor to provide the upgrade file. The upgrade file is the same as the model and hardware version of the instrument, the software version is higher than the version of the instrument. Save the upgrade file in the root directory of the USB.
- ③ The instrument is in shut down state. Insert USB and boot up the instrument, press the power softkey, the instrument will automatically detect and to update.
- ④ The upgrade process takes 5 minutes. After the upgrade is finished, shut down the instrument and plug out USB.
- ⑤ Reboot the instrument to check that the system information is the same as the version supplied. If it is the same, the update is successful.

(2) Local upgrade

Save the upgrade file to USB and connect USB to the instrument. The upgrade can be processed when the instrument detects USB.

① Upgrade file

Click on the "Upgrade file" in the root directory of USB or click on the "Browse" to enter the file browser to select the upgrade file, and then click on the "Enter" to process the upgrade setting.

② Upgrade

Click on the "Upgrade" to pop up the upgrade confirmation box to choose whether "Enter" or "Cancel" the upgrade.

- Enter: process the upgrade according to the currently selected upgrade file

- Cancel: cancel the current upgrade, or click the icon  on the right to cancel

③ Disk manager

Click on the "Disk manager" to enter the file browser menu, for the use of file browser menu, refer to the section of [File Browser](#).

(3) Online upgrade

First of all, make sure that the LAN port on the rear panel of the instrument is connected to the network (if there is any restriction on the privileges, please open the network privileges).

Click on the "Online upgrade" to pop up the upgrade confirmation box to choose whether "Enter" or "Cancel" the upgrade.

- Enter: process the upgrade according to the currently selected upgrade file
- Cancel: cancel the current upgrade, or click the icon  on the right to cancel





Note: Please ensure that the power is not shut down during the entire upgrade process, it is to avoid failure to reboot due to incomplete system upgrade content.

19. Mathematical Operation

- [Basic Operation](#)
- [Digital Filter](#)
- [Advanced Operation](#)

MSO2000X/3000X series mixed signal oscilloscope carries a variety of mathematical operations, including Math, digital filter and advanced operation.

The “Math” menu can be entered by the following steps.

- Press the **Math** key on the front panel to enter the math setting menu.
- Click the Home icon  on the top right corner, and select the save icon  to enter the math setting menu.
- If the math function is added into the toolbar, click the counter icon  in the toolbar on the top right corner to enter the math setting menu.
- When Math1~Math4 is opened, click on the Math1~Math4 label at the bottom of screen, or click the icon  on the top right corner to enter the math setting menu.

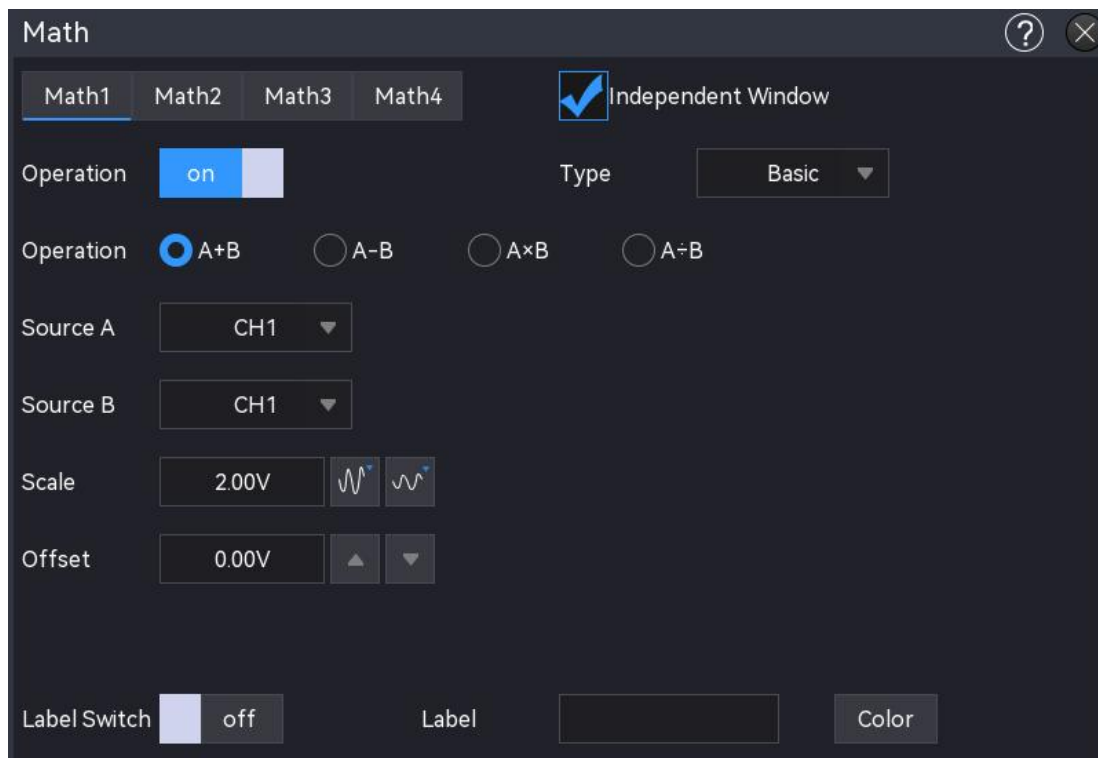

This oscilloscope supports 4 mathematical operations: Math1, Math2, Math3 and Math4, and also supports the result of Math wave displayed in a separate window, and the label and channel color can be set. In the Math menu, press Math1 ~ Math4 to select and set. In this chapter, Math1 is used



as an example to introduce the math function.

(1) Operation

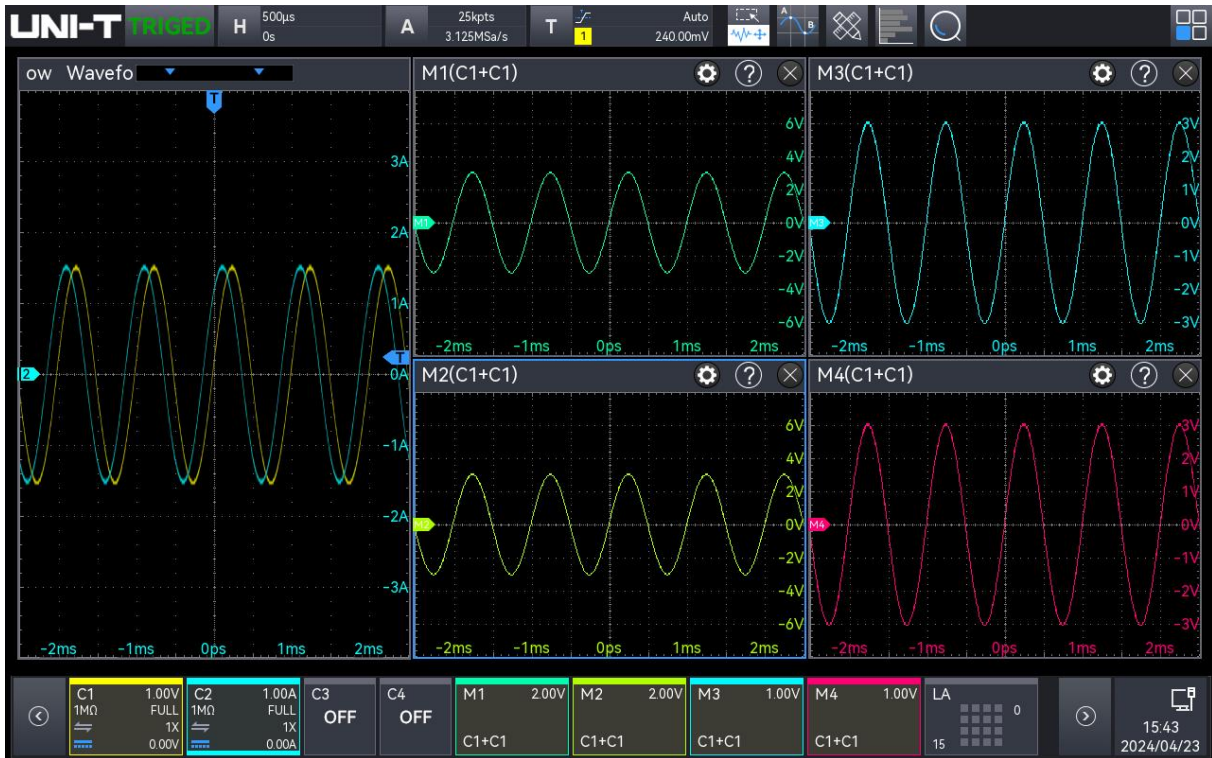
In the Math menu, click on the “Operation” to switch on/off the operation result of Math wave. The default is “OFF”. Once Math1~Math4 is set to “ON”, the operation result of Math wave will be displayed on the screen, as shown in the following figure.



(2) Separate window

The operation result of Math wave can be displayed in a separate window. Click on , 4 Math waves and the channel wave are displayed in a separate window. Click on , 4 Math waves and the channel wave are displayed in the same window.

When the operation result of Math wave is displayed in a separate window, drag the label bar above the window to change the window position, or click on the icon “x” on top right corner to close the window.

(3) Label

Set the wave label for the Math wave operation result display window, see the section of [6.10 Label](#) for setting.

(4) Channel color

Set the color for Math channel and Ref waveform and its label.

- Source: Click on the “Source” to select the source to set the color, the source can select M1, M2, M3, M4, R1, R2, R3, R4.
- Color: Tap the color plate and drag to select the color.

19.1. Basic Operation

In the Math menu, click on the “Math type” to select “Basic operation” to enter the setting.

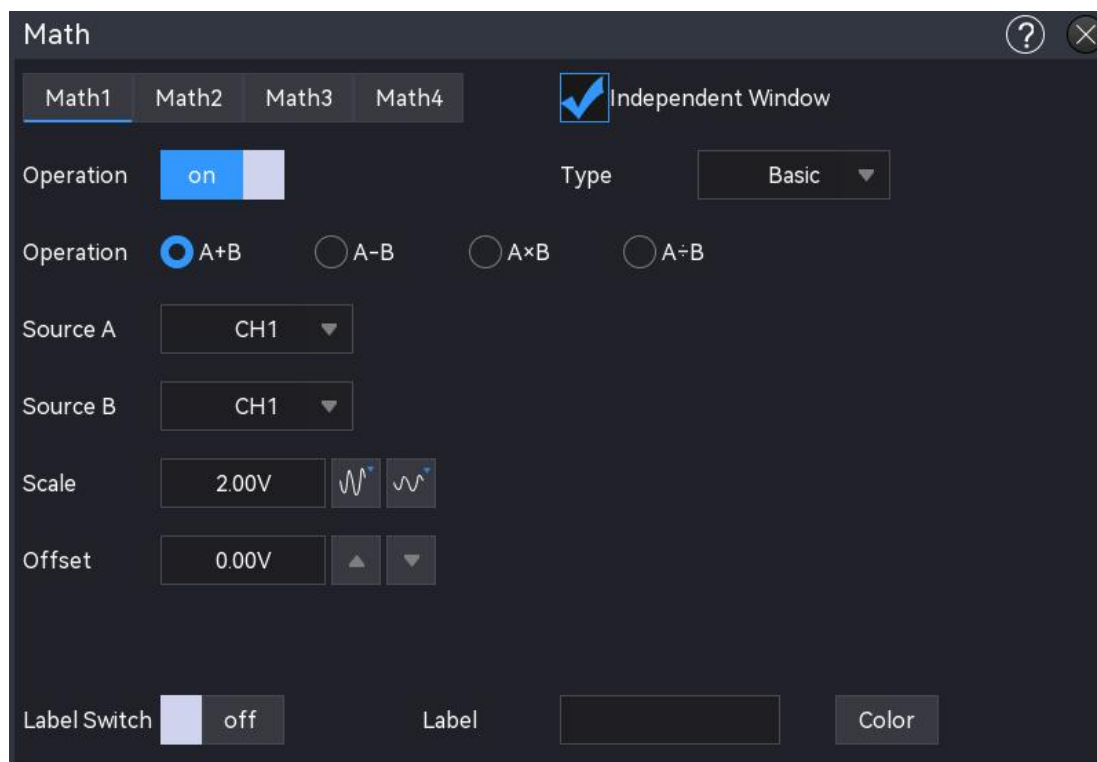

(1) Operation

- **A+B**: The waveform of source A and waveform of source B are added point by point and the results are displayed.
- **A-B**: The waveform of source A and waveform of source B are subtracted point by point and the results are displayed.
- **A×B**: The waveform of source A and waveform of source B are multiplied point by point and the results are displayed.
- **A÷B**: The waveform of source A and waveform of source B are divided point by point and the results are displayed. It is used to analyze the multiple relation between two channel waveforms.

Note: When the voltage of source B is 0, the divide result is 0.

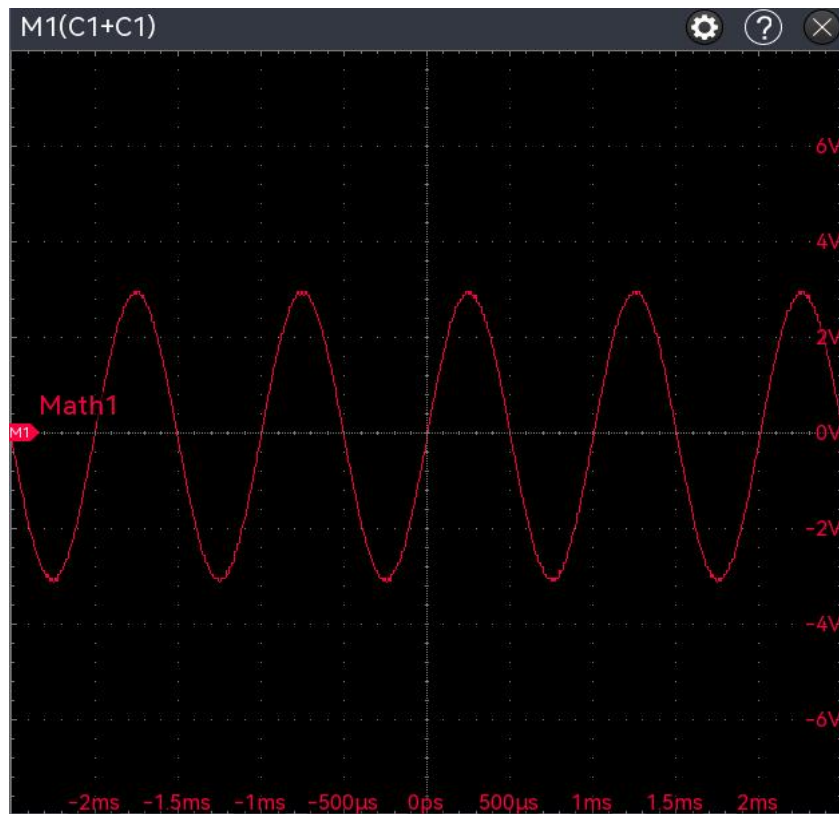



Display window of operation result

(2) Source

Click on the “Source A” or “Source B” to select CH1~CH4 or Ref1~Ref4.



(3) Vertical scale

Set the vertical scale of Math wave in the display window, it can be set by the following steps.

- In “Math” menu, click on the “Vertical scale” text field, rotate the Multipurpose rotary knob on the front panel to change the vertical scale.
- Tap the vertical scale icon ,  on the right to increase or decrease the vertical scale.
- Double-click on “Vertical scale” text field to pop up the numeric keyboard to enter the specified numeric value. For details on the use of the numeric keyboard, refer to the section of [5.8 Parameter Setting](#).

(4) Vertical position

Set the vertical offset of Math wave in the display window, it can be set by the following steps.

- In “Math” menu, click on the “Vertical position” text field, rotate the Multipurpose rotary knob on the front panel to change the vertical position.
- Tap the vertical position icon ,  on the right to increase or decrease the vertical scale.
- Double-click on “Vertical position” text field to pop up the numeric keyboard to enter the specified numeric value. For details on the use of the numeric keyboard, refer to the section of [5.8 Parameter Setting](#).

19.2. Digital Filter

In the “Math” menu, click on the “Math type” to select “Filter” to enter the setting.

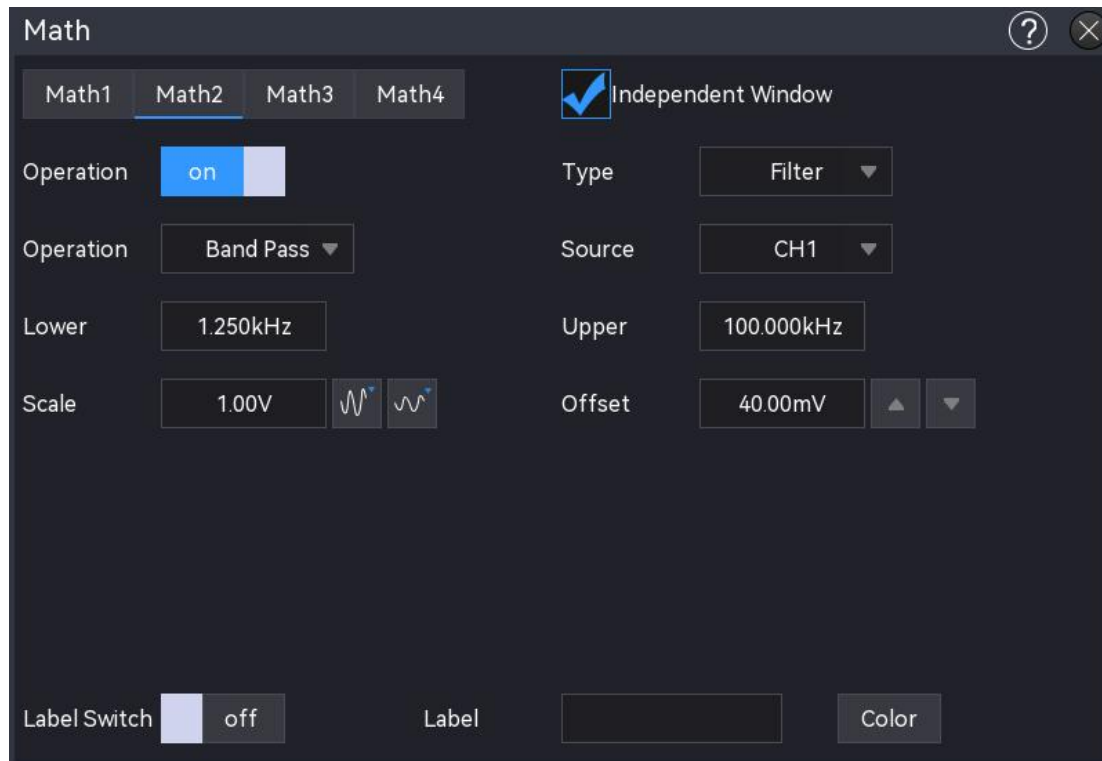

(1) Source

Click on the “Source” to select CH1~CH4.

(2) Filter type

- Low pass: Only signal with the source frequency lower than the upper limit of the current frequency are allowed to pass.
- High pass: Only signal with the frequency higher than the lower limit of the current frequency are allowed to pass.
- Band pass: Only signal with the frequency higher than the lower limit of current frequency and lower than upper limit of the current frequency are allowed to pass.
- Band Limited: Only signal with the frequency lower than the lower limit of the current frequency or higher than the upper limit of the current frequency are allowed to pass.

(3) Lower limit of frequency

Click on the “Lower limit of frequency” text field, and rotate the Multipurpose rotary knob on the front panel to change the lower limit of frequency; or double-click on “Lower limit of frequency” text field to pop up the numeric keyboard to directly enter the lower limit of frequency. For details on the use of the numeric keyboard, refer to the section of [5.8 Parameter Setting](#). In low-pass mode, the lower frequency limit setting is invalid and the menu is hidden.



(4) Upper limit of frequency

Click on the “Upper limit of frequency” text field, and rotate the Multipurpose rotary knob on the front panel to change the upper limit of frequency; or double-click on “Upper limit of frequency” text field to pop up the numeric keyboard to directly enter the upper limit of frequency. For details on the use of the numeric keyboard, refer to the section of [5.8 Parameter Setting](#). In high-pass mode, the upper frequency limit setting is invalid and the menu is hidden.

Note: The range of upper/lower limit of frequency is related to the current horizontal time base.



(5) Vertical scale

Set the vertical scale of Math wave in the operation result display window, it can be set by the following steps.

- In “Math” menu, click on the “Vertical scale” text field, rotate the Multipurpose rotary knob on the front panel to change the vertical scale.
- Tap the vertical scale icon ,  on the right to increase or decrease the vertical scale.
- Double-click on “Vertical scale” text field to pop up the numeric keyboard to enter the specified numeric value. For details on the use of the numeric keyboard, refer to the section of [5.8 Parameter Setting](#).

(6) Vertical position

Set the vertical offset of Math wave in the operation result display window, it can be set by the following steps.

- In “Math” menu, click on the “Vertical position” text field, rotate the Multipurpose rotary knob on the front panel to change the vertical position.
- Tap the vertical scale icon ,  on the right to increase or decrease the vertical position.
- Double-click on “Vertical position” text field to pop up the numeric keyboard to enter the specified numeric value. For details on the use of the numeric keyboard, refer to the section of [5.8 Parameter Setting](#).

19.3. Advanced Operation

In the “Math” menu, click on the “Math type” to select “Advanced” to enter the setting. Advanced operations allow the user to freely define the relevant operations for each signal input channel to obtain Math waveforms with different operation results.

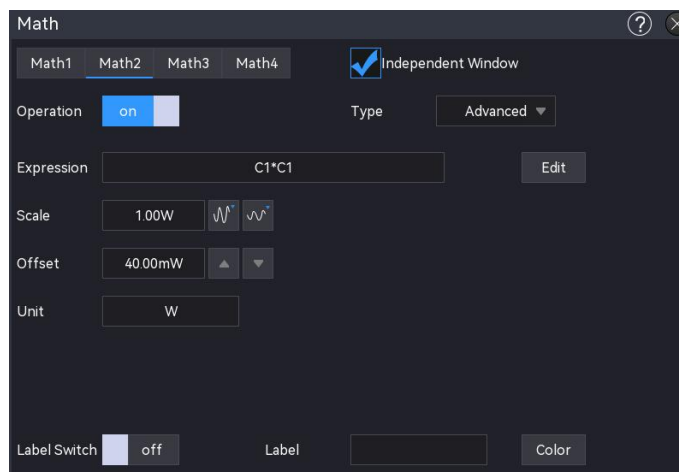

(1) Expression

Double-click on “Expression” text field or click the “Edit” on the right to enter the setting. The function operation can be edited in the expression window, as shown in the following figure.

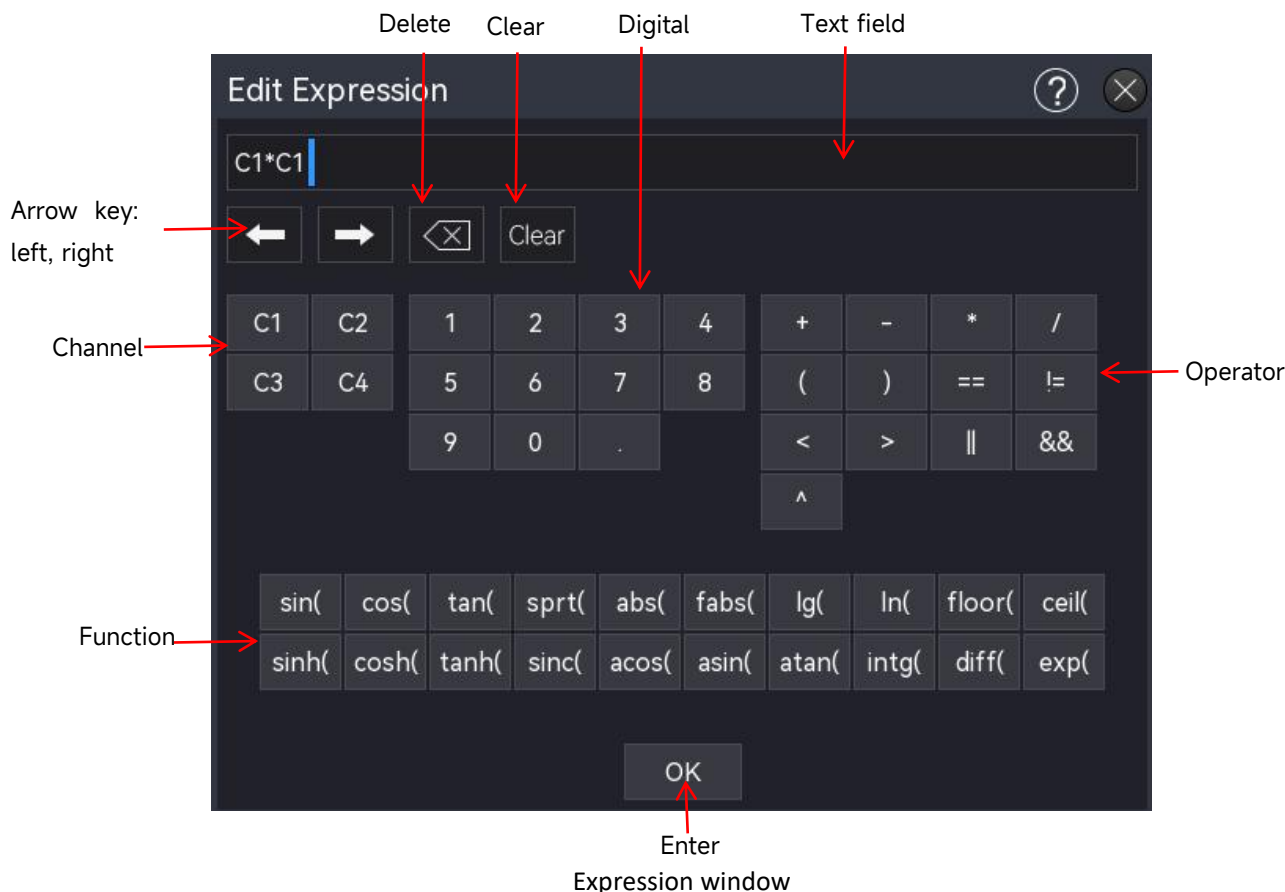

(2) Edit expression

- a. Expression: It represents the formula consist of channel, function, variation and operator. The length of expression cannot over 13 characters.
- b. Channel: CH1~CH4
- c. Function: Table

Function Name	Description
Sin	Calculating the sine of the selected source.
Cos	Calculating the cosine of the selected source.
Sinc	Calculating the normalization value of the selected source.
Tan	Calculating the tangent of the selected source.
abs	The selected source take the absolute value (integer absolute value).
fabs	The selected source take the absolute value (floating number absolute value).
exp	Calculating the exponent of the selected source.
Lg	Calculating the logarithm of the selected source.
ln	Calculating the logarithm of the selected source.
floor	The selected source is round down to an integer.
ceil	The selected source is round up to an integer.
sinh	Calculating the hyperbolic sine of the selected source.
cosh	Calculating the hyperbolic cosine of the selected source.
tanh	Calculating the hyperbolic tangent of the selected source.
Sinc	Calculating the normalization value of the selected source.
acos	Calculating the arccosine of the selected source.
asin	Calculating the arcsine of the selected source.
atan	Calculating the inverse tangent of the selected source.
intg	Calculating the integral of the selected source.
diff	Calculating the differential of the selected source.



d. Operator: Table

Operator	Description
+ - * / ^	Mathematical operator: add, subtract, multiply, divide, exponent
()	Parentheses is used to raise the priority of operations in parentheses.
< > == !=	Relation operator: greater than, less than, equal to, unequal to

, &&	Logical operator: or, and
0 ~ 9, .	Perform digit operation



(3) Vertical scale

Set the vertical scale of Math wave in the operation result display window, it can be set by the following steps.

- In “Math” menu, click on the “Vertical scale” text field, rotate the Multipurpose rotary knob on the front panel to change the vertical scale.
- Tap the vertical scale icon ,  on the right to increase or decrease the vertical scale. Double-click on “Vertical scale” text field to pop up the numeric keyboard to enter the specified numeric value. For details on the use of the numeric keyboard, refer to the section of [5.8 Parameter Setting](#).

(4) Vertical position

Set the vertical offset of Math wave in the operation result display window, it can be set by the following steps.





- In “Math” menu, click on the “Vertical position” text field, rotate the Multipurpose rotary knob on the front panel to change the vertical position.
- Tap the vertical scale icon ,  on the right to increase or decrease the vertical position.
- Double-click on “Vertical position” text field to pop up the numeric keyboard to enter the specified numeric value. For details on the use of the numeric keyboard, refer to the section of [5.8 Parameter Setting](#).

20. FFT

Using FFT (Fast Fourier Transform) mathematical operations, the time domain signal (YT) can be converted into frequency domain signal. This oscilloscope has an FFT function. This allows the user to view the frequency spectrum of the signal while viewing the waveform in the time domain. The following types of signals can be easily observed by using FFT.

- Harmonic component and distortion in measurement system
- Perform the noise feature in DC power supply
- Vibration analysis

“FFT” menu can be entered by the following steps.

- Press the  key on the front panel to open the FFT function.
- Click the Home icon  on the top right corner, and select the FFT icon  to open the FFT function.
- If the FFT function is added into the toolbar, click the FFT icon  in the toolbar on the top right corner to open the FFT function.
- When FFT1~FFT4 is opened, click on the FFT1~FFT4 label at the bottom of the screen, click on the icon  on the top right corner to open the FFT function.

The oscilloscope supports four FFT operations: FFT1, FFT2, FFT3, and FFT4, and the operation results are displayed in an independent window. In the "Math FFT" menu, press FFT1 ~ FFT4 to select and set. In this chapter, FFT1 is used as an example to introduce the FFT function.

FFT setting menu has two submenu, “Normal” and “Trace”. Click on the “Normal” or “Trace” to set or slide the menu to select and set.

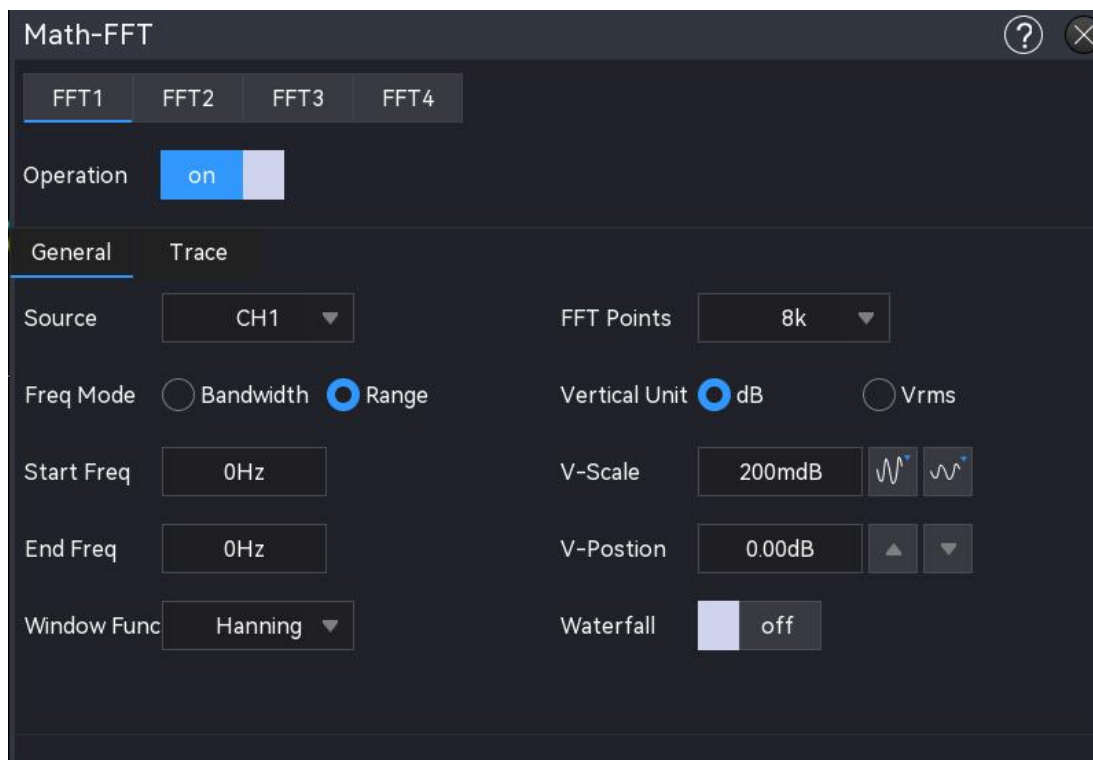

(1) Operation

Click on the “Operation” to open the FFT operation window.

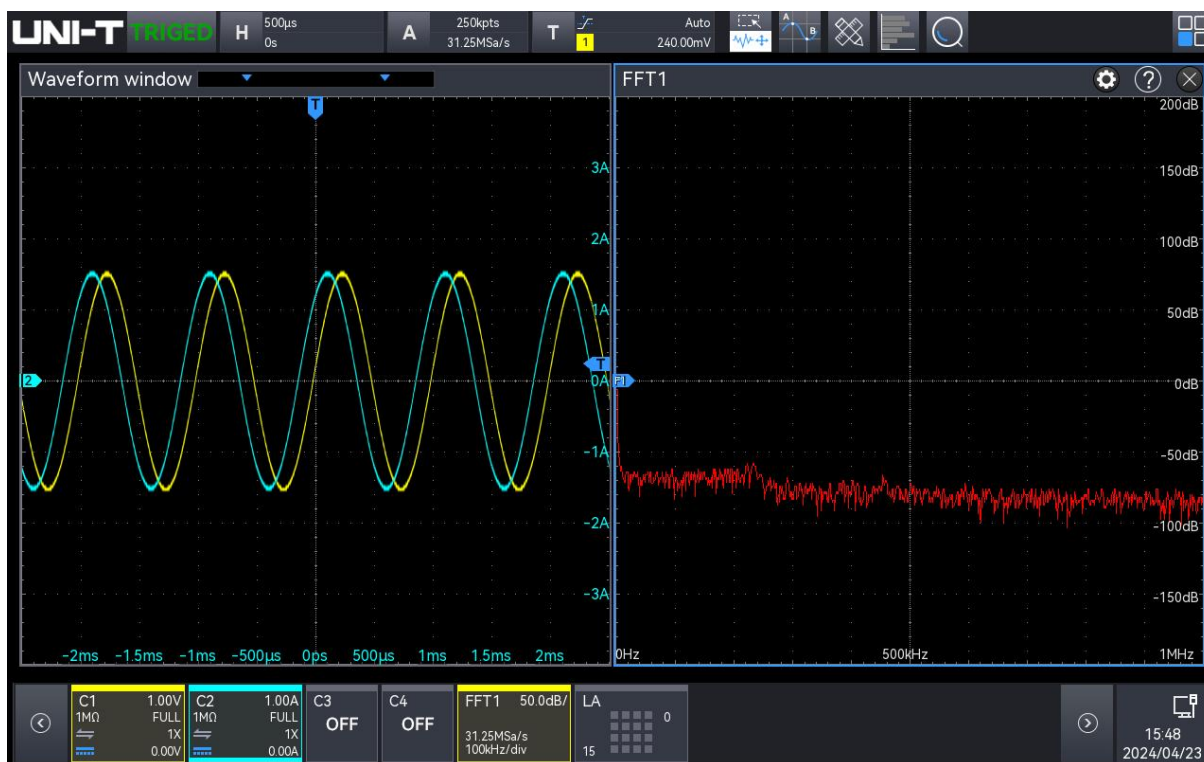

(2) Source

Click on the “Source” to select CH1~CH4.

(3) FFT Count

The number of points processed by the FFT spectrum, it can set to 8 k, 16 k, 32 k, 64 k, 128 k,

256 k, 512 K, 1M, 2M, 4M.

(4) Frequency mode

a. Range

- Start frequency: Click the "Start Frequency" text field on the left of the window to pop up the numeric keyboard to set the start frequency; or select the "Start frequency" and rotate the Multipurpose rotary knob to set the start frequency, clockwise: increase, anticlockwise: decrease.
- Stop frequency: Click the "Stop frequency" text field on the right of the window to pop up the numeric keyboard to set the stop frequency. For details on the use of the numeric keyboard, refer to the section of [5.8 Parameter Setting](#); or select the "Stop frequency" and rotate the Multipurpose rotary knob to set the stop frequency, clockwise: increase, anticlockwise: decrease.

b. Bandwidth

- Center frequency: The frequency is corresponding to the center of window. Click the "Center frequency" text field on the right of the window to pop up the numeric keyboard to set the center frequency. For details on the use of the numeric keyboard, refer to the section of [5.8 Parameter Setting](#); or select the "Stop frequency" and rotate the Multipurpose rotary knob to set the center frequency, clockwise: increase, anticlockwise: decrease. The center frequency range can be set to $0 \text{ Hz} \sim \text{bandwidth} \div 2$.
- Bandwidth: The frequency range of frequency domain waveform, set the bandwidth for FFT sweep, Click the "Bandwidth" text field on the right of the window to pop up the numeric keyboard to set the bandwidth. For details on the use of the numeric keyboard, refer to the section of [5.8 Parameter Setting](#); or select the "Bandwidth" and rotate the Multipurpose rotary knob to set the bandwidth, clockwise: increase, anticlockwise: decrease. The center frequency range can be set to $0 \text{ Hz} \sim 2.5 \text{ GHz}$.

(5) Vertical unit

FFT operation result unit can be set to Vrms or dB. Vrms and dBm display the vertical amplitude size in linear and decibel volts respectively. If the FFT spectrum need to be displayed in a large dynamic range, dBm is recommended.

(6) Window function



The window function is used to reduce the problem of spectral leakage. This oscilloscope provides 4 FFT window functions, each window function is for difference waveforms, as shown in the following table, and the selection is based on the measured waveform and its features.

Window function

Window function	Feature	Waveform
Rectangle	It has the best frequency resolution and the worst amplitude resolution, which is similar to the one with no window.	Transient or short pulse, the signal level is almost equal to before and after Equal amplitude sine wave with very similar frequency Wide-band random noise in a slowly changing spectrum
Hanning	Compared with the rectangle window, it has better frequency resolution, but poorer amplitude resolution.	Sine wave, period and narrow-band random noise
Hamming	The frequency resolution is slightly better than that of Hanning window.	Transient or short pulse, the signal level is very different before and after
Blackman	It has the best amplitude resolution, and the worst frequency resolution.	Single frequency signal, seeking for higher harmonic



(7) Vertical scale

Set the vertical scale of FFT wave in the display window, it can be set by the following steps.

- In “Math” menu, click on the “Vertical scale” text field, rotate the Multipurpose rotary knob on the front panel to change the vertical scale.
- Tap the vertical scale icon ,  on the right to increase or decrease the vertical scale.
- Double-click on “Vertical scale” text field to pop up the numeric keyboard to enter the specified numeric value. For details on the use of the numeric keyboard, refer to the section of [5.8 Parameter Setting](#).

(8) Vertical position

Set the vertical offset of FFT wave in the display window, it can be set by the following steps.

- In “Math” menu, click on the “Vertical position” text field, rotate the Multipurpose rotary knob on the front panel to change the vertical position.
- Tap the vertical position icon ,  on the right to increase or decrease the vertical scale.
- Double-click on “Vertical position” text field to pop up the numeric keyboard to enter the specified numeric value. For details on the use of the numeric keyboard, refer to the section of [5.8 Parameter Setting](#).

(9) Waterfall curve

Click on the “Waterfall curve” to switch on/off whether the waterfall curve is opened in FFT

wave.

- ON: The spectrum and waterfall curve are split to upper and lower part for display, the waterfall curve reflects the change in dB value over time in the spectrum, and has record function. The waterfall plot can only be selected when the Enhanced FFT is enabled. The record is up to 200 (the spectrum with respect to the waterfall curve).
- OFF: Display FFT wave and its coordinate

(10) Trace

In FFT setting menu, click on the “Trace” or slide the menu to left and right to enter the trace setting menu. The trace is used to display the graph of the points drawn on the raw data after the FFT operation.

a. Trace

- Normal: The spectrum waveform graph shows all the sampled values in real time, the spectrum waveform display in red.
- Average: The spectrum waveform graph shows the average value of several points taken during the sampling interval, the spectrum waveform display in blue.
 - of several points taken during the sampling interval,
 - Average time: set the number of average calculation, double-click on the “Average time” text field to pop up the numeric keyboard to set the average time. For details on the use of the numeric keyboard, refer to the section of [5.8 Parameter Setting](#); or select this parameter and rotate the Multipurpose rotary knob to change the count to set the average time. The range of average time can be set to 2~8192. The greater the number, the smoother the average spectrum.
- Maximum hold: The spectrum waveform graph shows the maximum value of the data from multiple sample, and the spectrum waveform display in yellow.
- Minimum hold: The spectrum waveform graph shows the minimum value of the data from multiple sample, and the spectrum waveform display in grey.

b. Sampling mode

- OFF: turn off the current detection waveform
- + Peak: It takes and displays the maximum value in each sample interval.
- - Peak: It takes and displays the minimum value in each sample interval.
- Average: It takes and displays the average value in each sample interval.
- Sampling: It takes and displays the first value in each sample interval.

(11) Marker

The spectrum marker is used to mark the point in the spectrum and display the frequency and voltage.

a. Auto

- Mark trace: Select the spectrum waveform as the marker source, i.e. the spectrum waveform generated by different types of detector mode. Click on the “Mark trace” to select normal, average, maximum hold, minimum hold.
- Mark count: Set the maximum number of points that can be marked, double-click on “Mark count” text field to pop up the numeric keyboard to set the mark count. For details on the use of the numeric keyboard, refer to the section of [5.8 Parameter Setting](#); or select this parameter and rotate the Multipurpose rotary knob to change the mark count. The range of mark count can be set to 1 ~ 10.
- Mark list: Click on the “Mark list” to switch on/off the mark list.
ON: display the mark list: count number, frequency, and voltage.
OFF: not display the mark list.

b. Threshold

- Mark trace: Select the spectrum waveform as the marker source, i.e. the spectrum waveform generated by different types of detector mode. Click on the “Mark trace” to select normal, average, maximum hold, minimum hold.
- Mark count: Set the maximum mark count. Double-click on the “Mark Count” text field to pop up the numeric keyboard to set the mark count. For details on the use of the numeric keyboard, refer to the section of [5.8 Parameter Setting](#); or select this parameter and rotate the Multipurpose rotary knob to change the mark count, it can be set to 1 ~ 10.
- Mark threshold: Set the compare condition, the marker will be displayed when the peak is greater than the set threshold, otherwise, the marker will not be displayed. Double-click on “Mark threshold” text field to pop up the numeric keyboard to set the mark threshold For details on the use of the numeric keyboard, refer to the section of [5.8 Parameter Setting](#); or select this parameter and rotate the Multipurpose rotary knob to change the mark threshold.
- Mark list: Click on the “Mark list” to switch on/off the mark list.
ON: display the mark list: count number, frequency, and voltage.
OFF: not display the mark list.

c. Manual: Move the marker cursor to any point on the trace by rotating the Multipurpose rotary knob.

- Mark trace: Select the spectrum waveform as the marker source, i.e. the spectrum waveform generated by different types of detector mode. Click on the “Mark trace” to select normal, average, maximum hold, minimum hold.

Note: If the selected marker trace is not displayed, there is no marker point, and the trace can be marked until the trace is displayed.

21. Digital Channel

- [Basic](#)
- [Group](#)
- [Threshold](#)
- [Bus](#)
- [Label](#)

MSO2000X/3000X series has 4 analog channels and 16 digital channel. For digital channel, the oscilloscope will compared the sampled voltage of each time to the preset logical threshold. If the voltage of sampling point is greater than threshold, it will saved as logic 1. Otherwise, it will saved as logic 0. The oscilloscope can intuitively display the logic 1 and logic 0 in figure. It's convenient for user to detect and analysis the error in circuit design (hardware and software design).

This chapter is to introduce how to use the digital channel of MSO2000X/3000X series mixed signal oscilloscope.

Before using the digital channel, use the accessory UT-M15 logical probe to connect to the oscilloscope and the device under test. For the use of logical probe, refer to <<*UT-M15 Logical Probe User's Manual*>>.

The digital channel menu can be entered by the following steps.

- Press the Digital key on the front panel to enter the digital channel menu.
- Click the Digital icon  at the bottom of the screen to enter the digital channel menu.

21.1. Basic



- (1) Display: Click on the “Display” to switch on/off the digital channel.
 ON: when the channel is selected, the digital channel will be displayed on the screen.
 OFF: The digital channel will be not displayed on the screen even if the channel is selected.
 - (2) Channel: Select a channel to be the current channel, and display in blue to distinguish from other channels.
 - (3) Channel selection: D0~D15 can be opened by pressing any one of channel. The selected channel is displayed in blur. When the display is opened, the selected channel will be displayed on the screen.
 - Select all: quick select all the digital channels
 - Delete: quick delete the state of all the digital channels
 - (4) Click on the “D15-D8, D7-D0” to quickly set the channel display state.
 ON: select the digital channel of D15-D8, D7-D0
 OFF: not select any one of the digital channel
 - (5) Open/close group: the selected group is displayed in . If the group has a digital channel, the digital channel will be displayed on the screen (refer to Group for more details).
 - (6) Waveform size: Click on the “Waveform size” to set the waveform size to display in S (small), M (middle) or L (large), and the default is S. .
- Note:** L (large) can only be used when the open channel is not more than 8.
- (7) Waveform rank: Click on the “Waveform rank” to set the digital channel sequence, from up to

down. It can set to “D0-D15” or “D15-D0”, and the default is “D0-D15”.

- (8) Delay time: When using an oscilloscope for actual measurements, the transmission delay of the probe cable can introduce a large error (zero offset).

Zero offset is defined as the offset of the intersection of the waveform and trigger level line from the trigger position.

Double-click on the “Delay time” text field to pop up the numeric keyboard to set the delay time. For details on the use of the numeric keyboard, refer to the section of [5.8 Parameter Setting](#); or select this parameter and rotate the Multipurpose rotary knob to change the delay time. The range can be set to -100 ns~100 ns.

21.2. Group

The group setting can group or ungroup any of the 16 digital channels into 4 groups, a channel can be added to more than one group, and the background of the channel added to the current group is displayed in blue.

- (1) Group: Click on the “Group” to select group 1, group 2, group 3 or group 4.
- (2) Select all: Add D0~D15 to the current group. And all the digital channels are displayed in blue.
- (3) Reset: Reset the digital channel in the current group to the default 4 digital channels.
- (4) Clear: Clear all the digital channels in the current group.

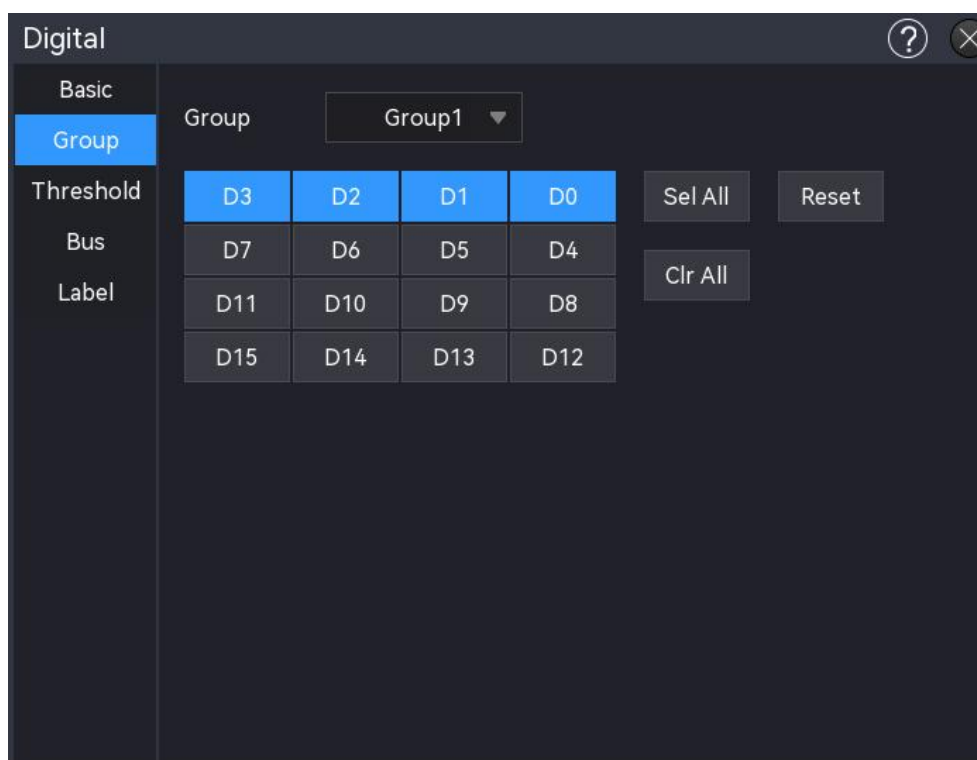

21.3. Threshold

The threshold level of "D7~D0" and "D15~D8" channels can be set independently, and the thresholds for the two groups of channels can be set independently as required. If the voltage of the input signal is greater than the currently set threshold, it is judged as logic 1, otherwise it is judged as logic 0.

- (1) Preset threshold: TTL(1.4V), CMOS5.0 (2.5V), CMOS3.3 (1.65V), CMOS2.5 (1.25V), CMOS1.8 (0.9V), ECL(-1.3V), PECL(3.7V), CLDS(1.2V) and 0V. Once the threshold is selected, it will apply to the group.
- (2) Custom: Click on the "Custom" to pop up the numeric keyboard to set the custom threshold. The range can be set to -20.0 V ~ +20.0 V.

21.4. Bus

Digital channels can be combined and displayed as bus, with each bus value displayed at the bottom of the screen as binary, decimal, hexadecimal, ASCII. The figure is displayed at the bottom of the screen. Up to two buses can be created.

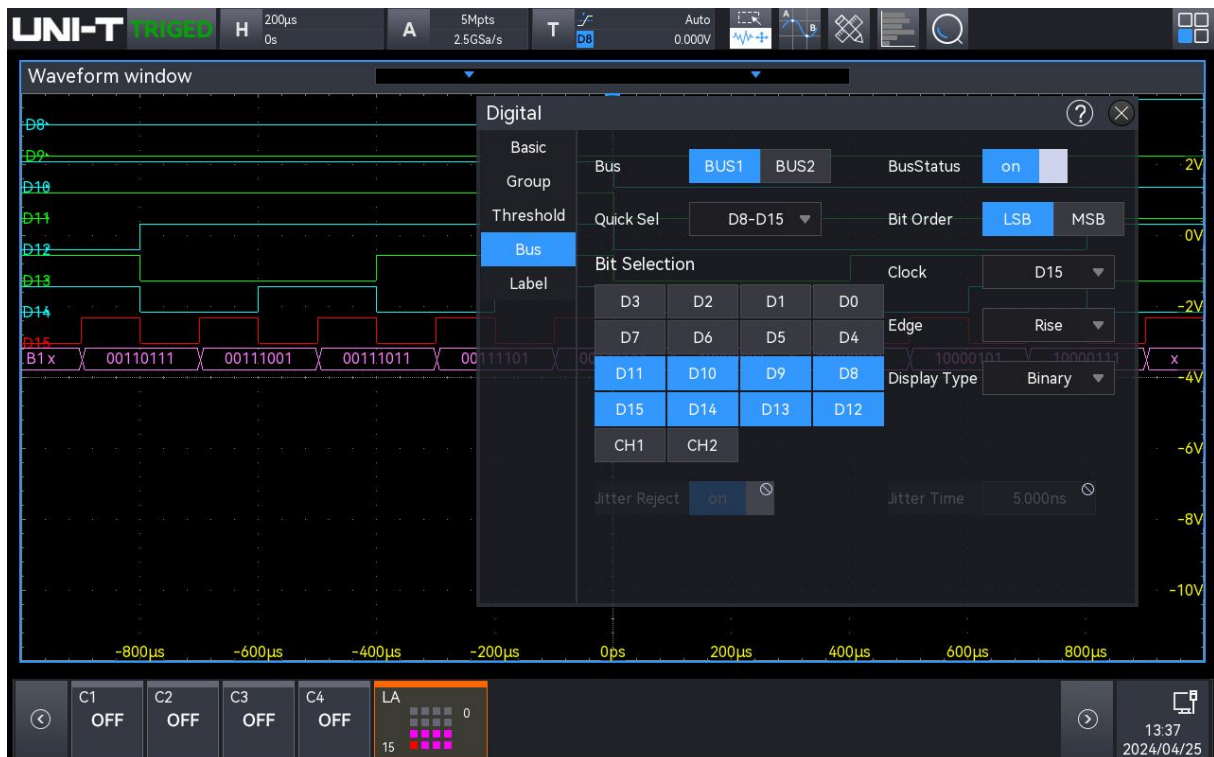

- (1) Bus: Click on the "Bus" to select the bus, "BUS1" or "BUS2".
- (2) Bus state: Click on the "Bus state" to switch on/off the bus display state.
- (3) Quick selection: Click on the "Quick selection" to select the channel group which correspond to BUS1 or BUS2, it can be select to D0-D7, D8-D15, D0-D15, group 1, group 2, group 3, group

4 or None.

- (4) Bit: Manually elect the channel bit that correspond to the bus, it can be select to D0 ~ D15, CH1, CH2, the selected digital channel is displayed in blue.
- (5) Bit sequence: Click on the "Bit sequence" to select "LSB (low to high)" (D0 is at the low bit) or "MSB (high to low)" (D0 is at the high bit).
- (6) Clock: Click on the "Clock" to select any one of channel (D0 ~ D15, CH1, CH2) to the reference clock for bus. The reference clock will not be set if "Null" is selected.
- (7) Edge type: Click on the "Edge type" to select "Rising/falling edge". The edge type of the currently selected channel can be the reference, to judge other channel is logic 1 or logic 0.
- (8) Display type: Click on the "Display type" to set the bus format to binary, decimal, hexadecimal, ASCII. The oscilloscope will display the bus data as the level of the corresponding value in a specific way in the graphics mode, making it easy to observe the trend of the bus value, as shown in the following figure.
- (9) Jitter proof: Click on the "Jitter proof" to switch on/off the jitter proof function.
Jitter: It indicates the short-term deviation of a signal at a particular moment relative to its ideal time position. If the bus is not select the reference clock, the hopping state of each channel will cause the change of the bus data. When bus data changes, unnecessary data will occurs due to the shaking. When shake proof is opened, the bus will not display the change in bus data caused by a certain shake time, but still maintain the valid data.
- (10) Jitter time: Double-click on "Jitter time" text field to pop up the numeric keyboard to set the jitter time. For details on the use of the numeric keyboard, refer to the section of [5.8 Parameter Setting](#); or select this parameter and rotate the Multipurpose rotary knob to change the jitter time. The range can be set to 0 ns ~ 50us.

Note: Jitter proof and Jitter time can only be set when data bus has no reference clock.



21.5. Label

Label setting is used to set the label for the specified digital channel.

(1) Preset Label

Select a digital channel (D0-D7, D8-D15) and then select a preset label for it.

Preset label: ACK, AD0, ADDR, BIT, CAS, CLK, CS, DATA, HALT, INT, LOAD, NIMI, OUT, RAS, PIN, RDY, RST, RX, TX, WR, MISO, MOSI.

(2) Custom label

Select a digital channel (D0-D7, D8-D15) and then set a custom label for it.

Double-click on the "Label" text field to pop up the numeric keyboard to set the custom label.



For details on the use of the numeric keyboard, refer to the section of [5.8 Parameter Setting](#);

(3) Reset: Clear all channel's label and reset to the default.

22. Search and Guide



The search function allows the user to quickly find and highlight the events of interest, and then use the event navigation to quickly find the highlighted signals to view. Waveform search criteria can be set to edge, pulse width, slope, runt, window, delay, timeout, duration, setup&hold, Nth edge and code pattern. Navigation allows the user to quickly view and locate waveforms. Navigation includes time navigation, event navigation and frame segment navigation.

The search function can be opened by the follow steps.

- Click the Home icon  on the top right corner, and select the search icon  to open the search function.

22.1. Search

The search function looks for waveform specific edge and pulse width events and marks them with small inverted triangles () along the top of the waveform scale.

Click the Home icon  on the top right corner, and select the search icon  to open the search function, as shown in the following figure.

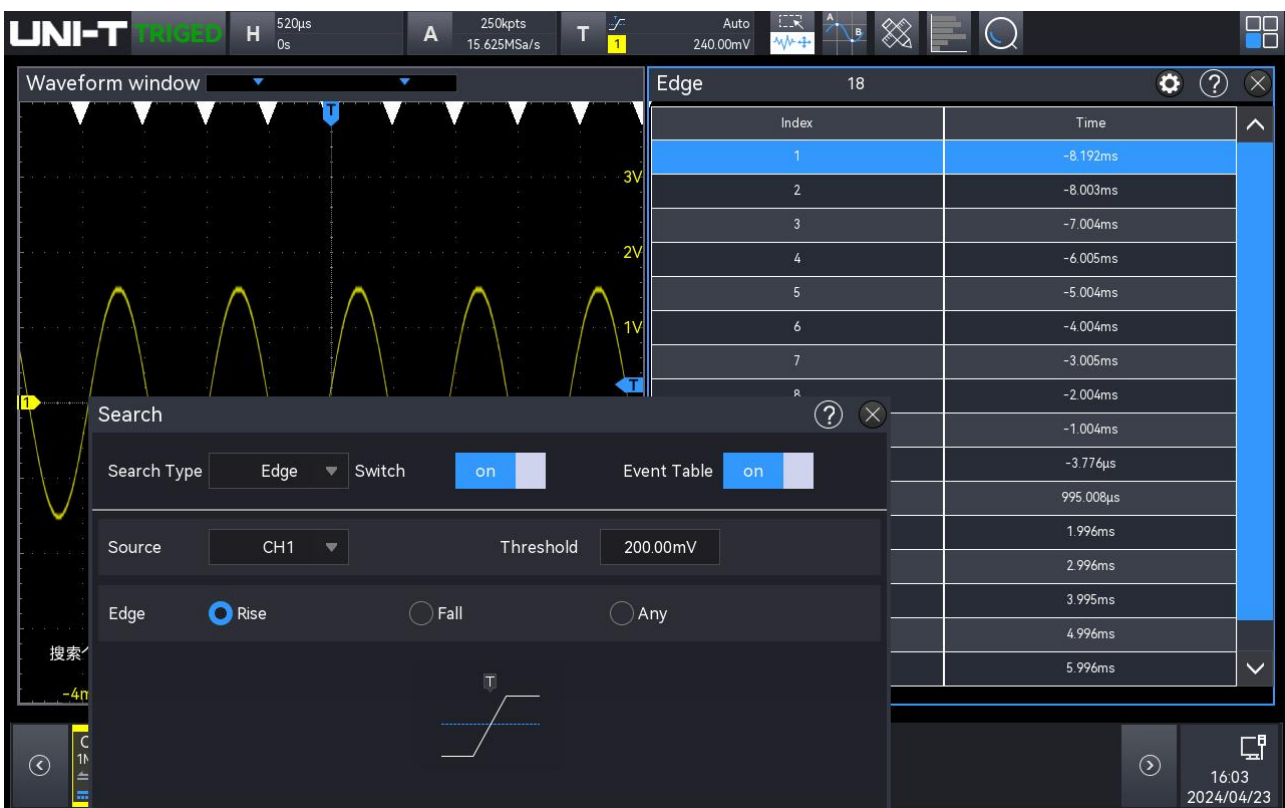

Index	Time
1	-8.192ms
2	-8.003ms
3	-7.004ms
4	-6.005ms
5	-5.004ms
6	-4.004ms
7	-3.005ms
8	-2.004ms
	-1.004ms
	-3.776μs
	995.008μs
	1.996ms
	2.996ms
	3.995ms
	4.996ms
	5.996ms

- Switch on/off search function

Click on the "Search" to switch on/off search function.

2. Search type

Click on the “Search type” to select edge, pulse width, slope, runt, over-amplitude, delay, timeout, duration, setup & hold, Nth edge and code pattern.

- Edge search: Click on the “Search type” and select “Edge”, for the edge type setting (source, trigger coupling, edge type, trigger level), refer to the section of [“Edge Trigger”](#).
- Pulse width search: Click on the “Search type” and select “Pulse width”, for the pulse width setting (source, polarity, upper limit, lower limit), refer to the section of refer to the section of [“Pulse Width Tigger”](#).
- Slope search: Click on the “Search type” and select “Slope”, for the slope setting (source, edge type, condition, upper limit of time, lower limit of time), refer to the section of refer to the section of [“Slope Trigger”](#).
- Runt search: Click on the “Search type” and select “Runt”, for the runt setting (source, polarity, runt condition, upper limit of time, lower limit of time), refer to the section of refer to the section of [“Runt Trigger”](#).
- Over-amplitude search: Click on the “Search type” and select “Over-amplitude”, for the Over-amplitude setting (source, edge type, search position, over-amplitude time), refer to the section of refer to the section of [“Over-amplitude Trigger”](#).
- Delay search: Click on the “Search type” and select “Delay”, for the delay setting (source, edge type, delay condition, upper limit of time, lower limit of time), refer to the section of refer to the section of [“Delay Trigger”](#).
- Timeout search: Click on the “Search type” and select “Timeout”, for the timeout setting (source, edge type, timeout type), refer to the section of refer to the section of [“Timeout Trigger”](#).
- Duration search: Click on the “Search type” and select “Duration”, for the timeout setting (source, code pattern, upper limit of time, lower limit of time), refer to the section of refer to the section of [“Duration Trigger”](#).
- Setup & Hold search: Click on the “Search type” and select “Setup & Hold”, for the setup & hold setting (data source, clock source, edge type, data type, trigger condition, time), refer to the section of refer to the section of [“Setup & Hold Trigger”](#).
- Nth edge search: Click on the “Search type” and select “Nth edge”, for the Nth edge setting (source, edge type, search position, time), refer to the section of refer to the section of [“Nth Edge Trigger”](#).
- Code pattern search: Click on the “Search type” and select “Code pattern”, for the code pattern setting (source, code patter), refer to the section of refer to the section of [“Code Pattern Trigger”](#).



23. Function/Arbitrary Waveform Generator

- [Open Function/Arbitrary Waveform Generator](#)
- [Basic Waveform Output](#)
- [Advanced Application](#)

MSO2000X/3000X has built-in function/arbitrary waveform generator. It uses direct digital combination technology to generate accurate and stable waveform output with the resolution lower to 1 μ Hz. MSO2000X/3000X is economical functional /arbitrary waveform generator.

23.1. Open Function/Arbitrary Waveform Generator

The “Gen” can be entered by the following steps.

- Press the **Gen** key on the front panel to enter the “Gen” menu.
- Click the Home icon  on the top right corner, and select the Gen icon  to enter the “Gen” menu.
- If the Gen function is added into the toolbar, click the counter icon  in the toolbar on the top right corner to enter the “Gen” menu.

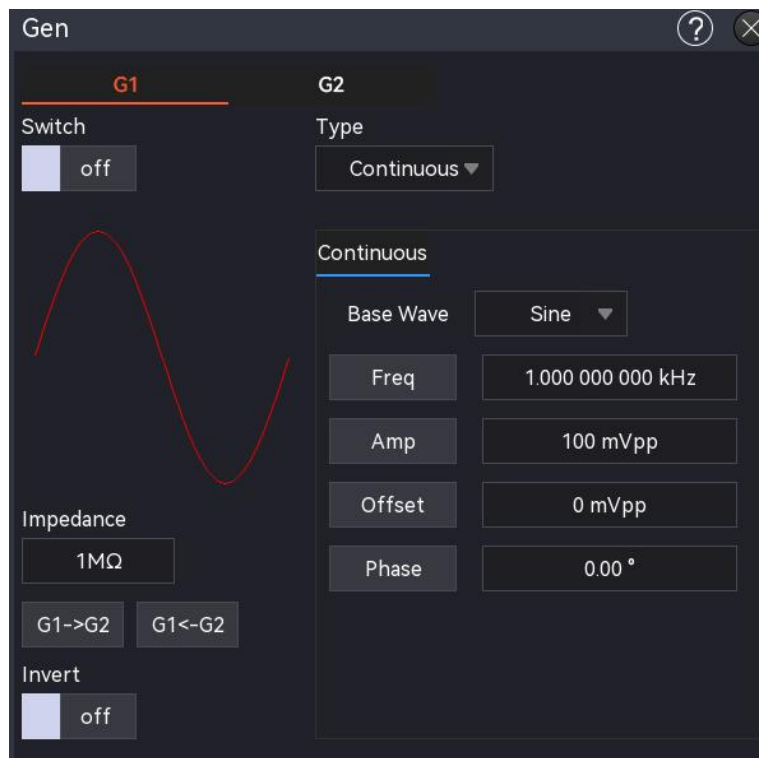

The oscilloscope supports two Gen signal outputs: G1, G2, click on the “Gen” to select G1, G2 tabs,

the selected tabs will be highlighted. This chapter uses G1 as an example to introduce Gen.

(1) Output switch

Click on the “Output switch” to set the G1 output state.

ON: Output the current G1 signal

OFF: not output the G1 signal

(2) Output type

Click on the “Output type” to select the output signal type to continuous waveform, AM waveform or FM waveform.

(3) Output impedance

Double-click on the “Output impedance” text field to pop up the numeric keyboard to set the impedance. For details on the use of the numeric keyboard, refer to “Enter character sting” in the section of [5.8 Parameter Setting](#). The selected output impedance must be match with the impedance of the connected oscilloscope, otherwise, the amplitude and offset level of waveform on the screen will be incorrect.

(4) Copy

Click on the “G1->G2” or “G1<-G2”, copy the signal in G1/G2 to G2/G1.

(5) Reversed output

Click on the “Reversed output” to switch on/off the reversed output.



ON: reverse AC of output signal

OFF: AC of output signal will not be reversed

(6) Waveform parameter

Double-click on the parameter text field to pop up the numeric keyboard to set the parameter.

For details on the use of the numeric keyboard, refer to the section of [5.8 Parameter Setting](#);

or select the arrow key ,  below the Multipurpose rotary knob to move the cursor and the rotate the Multipurpose rotary knob change the parameter value.

(7) Waveform figure: display the waveform of G1 signal

23.2. Basic Waveform

Gen can output waveforms from G1, G2 individually or simultaneously. By default, when Gen is switched on, the instrument outputs a sine wave with a frequency of 1 kHz and an amplitude of 100mVpp. This section uses G1 as an example to introduce how to configure the instrument to output different types of waveforms.



(1) Waveform type

Click on the “Basic wave” to select the waveform to sine, square, ramp, pulse wave, arbitrary,

noise and DC wave. The parameter of each waveform, refer to Table.



Continuous wave	Parameter	Frequency range	Amplitude range	Offset range
Sine wave	Frequency/cycle, amplitude/high level, DC offset/low level, phase ($\pm 360^\circ$)	1 μ Hz~50 MHz	20 mVpp~6 Vpp (high impedance); 10 mVpp~3 Vpp (50 Ω)	± 3 V (high impedance); ± 1.5 V (50 Ω)
Square wave	Frequency/cycle, amplitude/high level, DC offset/low level, phase ($\pm 360^\circ$), duty ratio (1%~99%)	1 μ Hz~15 MHz	20 mVpp~6 Vpp (high impedance); 10 mVpp~3 Vpp (50 Ω)	± 3 V (high impedance); ± 1.5 V (50 Ω)
Ramp wave	Frequency/cycle, amplitude/high level, DC offset/low level, phase ($\pm 360^\circ$), symmetry (0.1%~99.9%)	1 μ Hz~400 kHz	20 mVpp~6 Vpp (high impedance); 10 mVpp~3 Vpp (50 Ω)	± 3 V (high impedance); ± 1.5 V (50 Ω)
Pulse wave	Frequency/cycle, amplitude/high level, DC offset/low level, phase ($\pm 360^\circ$), pulse width/ duty ratio (1%~99%), rising, falling edge \uparrow	1 μ Hz~15 MHz	20 mVpp~6 Vpp (high impedance); 10 mVpp~3 Vpp (50 Ω)	± 3 V (high impedance); ± 1.5 V (50 Ω)
Arbitrary wave	Frequency/cycle, amplitude/high level, DC offset/low level, phase ($\pm 360^\circ$)	1 μ Hz~5 MHz	20 mVpp~6 Vpp (high impedance); 10 mVpp~3 Vpp (50 Ω)	± 3 V (high impedance); ± 1.5 V (50 Ω)
Noise	Amplitude/high level, DC offset/low level		20 mVpp~6 Vpp (high impedance); 10 mVpp~3 Vpp (50 Ω)	± 3 V (high impedance); ± 1.5 V (50 Ω)
DC	DC			± 3 V (high impedance); ± 1.5 V (50 Ω)

(2) Frequency



When Gen is switched on, the instrument will configure a default sine wave with a frequency of 1 kHz and an amplitude of 100mVpp. Double-click on the "Frequency" text field to pop up the numeric keyboard to set the frequency. For details on the use of the numeric keyboard, refer to the section of [5.8 Parameter Setting](#); or select the arrow key ,  below the [Multipurpose](#)

rotary knob to move the cursor and the rotate the Multipurpose rotary knob change the frequency.



(3) Amplitude

The default waveform is a sine wave with an amplitude of 100 mVpp. Double-click on the “Amplitude” to pop up the numeric keyboard to set the amplitude. For details on the use of the numeric keyboard, refer to the section of [5.8 Parameter Setting](#); or select the arrow key ,  below the Multipurpose rotary knob to move the cursor and the rotate the Multipurpose rotary knob change the amplitude.



(4) DC offset

The default DC offset of waveform is 0 V. Double-click on the “DC offset” to pop up the numeric keyboard to set the DC offset. For the details on the use of the numeric keyboard, refer to the section of [5.8 Parameter Setting](#); or select the arrow key ,  below the Multipurpose rotary knob to move the cursor and the rotate the Multipurpose rotary knob change the DC offset.



(5) Phase

The default phase of waveform is 0°. Double-click on the “Phase” to pop up the numeric keyboard to set the phase. For the details on the use of the numeric keyboard, refer to the section of [5.8 Parameter Setting](#); or select the arrow key ,  below the Multipurpose rotary knob to move the cursor and the rotate the Multipurpose rotary knob change the phase.

(6) Duty ratio of pulse wave



The default frequency is 1 kHz and the duty ratio is 50% of the pulse wave. Double-click on the “Duty ratio” to pop up the numeric keyboard to set the duty ratio. For the details on the use of the numeric keyboard, refer to the section of [5.8 Parameter Setting](#); or select the arrow key ,  below the Multipurpose rotary knob to move the cursor and the rotate the Multipurpose rotary knob change the duty ratio.

(7) Rising/Falling time



The default rising/falling time is 1 of the pulse wave. Double-click on the “Rising/Falling time” to pop up the numeric keyboard to set the rising/falling time. For the details on the use of the numeric keyboard, refer to the section of [5.8 Parameter Setting](#); or select the arrow key ,  below the Multipurpose rotary knob to move the cursor and the rotate the Multipurpose rotary knob change the rising/falling time.

(8) Ramp symmetry

The default symmetry of ramp wave is 50%. Double-click on the “Symmetry” to pop up the numeric keyboard to set the symmetry. For the details on the use of the numeric keyboard, refer

to the section of [5.8 Parameter Setting](#); or select the arrow key ,  below the Multipurpose rotary knob to move the cursor and the rotate the Multipurpose rotary knob change the symmetry.

(9) DC voltage

The default DC voltage is 0 V. Double-click on the “DC voltage” to pop up the numeric keyboard to set the DC voltage. For the details on the use of the numeric keyboard, refer to the section of [5.8 Parameter Setting](#); or select the arrow key ,  below the Multipurpose rotary knob to move the cursor and the rotate the Multipurpose rotary knob change the DC voltage.

23.3. Advanced Application

Gen can output amplitude modulation (AM), frequency modulation (FM), press the  on the front panel to open the function/arbitrary waveform generator, and enter the Gen setting menu to set decode, and select the modulation type through the "Output type". Take G1 as an example to introduce.

(1) Amplitude modulation (AM)

In AM, the modulation waveform is consist of carrier wave and modulation wave. The amplitude of carrier wave will change with the amplitude of modulation wave.

a. Enable AM

In G1 menu, select “Output type” to “AM”. The parameter of carrier wave and AM should be set, as shown in the following figure.

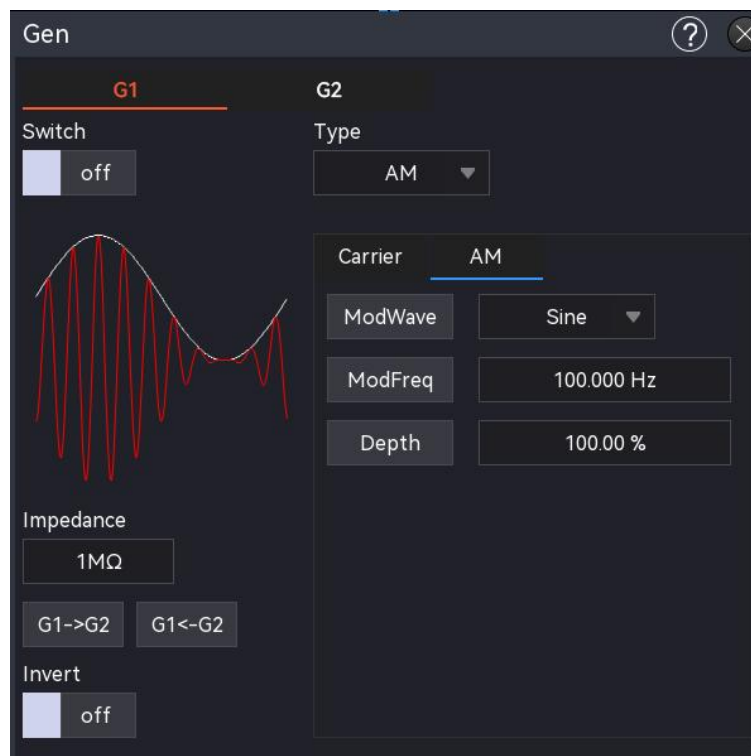

b. Select carrier wave

Click on the “Basic wave” to select sine, square, ramp or arbitrary wave.

■ Continuous wave setting



Once the carrier wave is selected, the parameter of the carrier wave should be set. For the carrier wave setting, refer to the section of [21.2 Basic Waveform](#).

c. Modulation wave setting



Modulation wave: sine, square, square, rising ramp, falling ramp, arbitrary, noise wave. The default is sine wave. Once AM is enabled, the modulation wave displays the sine wave. Click on the “Modulation wave” to change the modulation wave type. The modulation wave can refer to Table.

Modulation wave	Description
Square wave	Duty ratio is 50%
Rising ramp	Symmetry is 100%
Falling ramp	Symmetry is 0%
Arbitrary wave	Use automatic sampling to limit the arbitrary wave length at 4 kpts
Noise	White Gaussian noise

■ Modulating frequency

The modulating frequency range is 2 mHz ~ 50 kHz(default 100 Hz). Once AM is enabled, the default modulating frequency will be displayed. Double-click on the “Modulating frequency” text field to pop up the numeric keyboard to set the modulating frequency. For the details on the use of the numeric keyboard, refer to the section of [5.8 Parameter Setting](#); or select the arrow key ,  below the Multipurpose rotary knob to move the cursor and the rotate the Multipurpose rotary knob change the modulating frequency.

■ Modulating depth

The modulating depth indicates the change of amplitude, expressed in percentage. AM modulating depth is 0% ~ 120%, the default is range is 100%. Double-click on the “Modulating depth” text field to pop up the numeric keyboard to set the modulating depth. For the details on the use of the numeric keyboard, refer to the section of [5.8 Parameter Setting](#); or select the arrow key ,  below the Multipurpose rotary knob to move the cursor and the rotate the Multipurpose rotary knob change the frequency.

- When the modulating depth is 0%, it outputs a constant amplitude (half the amplitude of the carrier wave amplitude).

- When the modulating depth is 100%, the output amplitude is change with the modulation wave.
- When the modulating depth is greater than 100%, the output amplitude will not over than 10 Vpp (the load is 50 Ω).

(2) Frequency modulation (FM)

In FM, the modulation waveform is consist of carrier wave and modulation wave. The frequency of carrier wave will change with the amplitude of modulation wave.

a. Enable FM

In G1 menu, select “Output type” to “FM”. The parameter of carrier wave and FM should be set, as shown in the following figure.

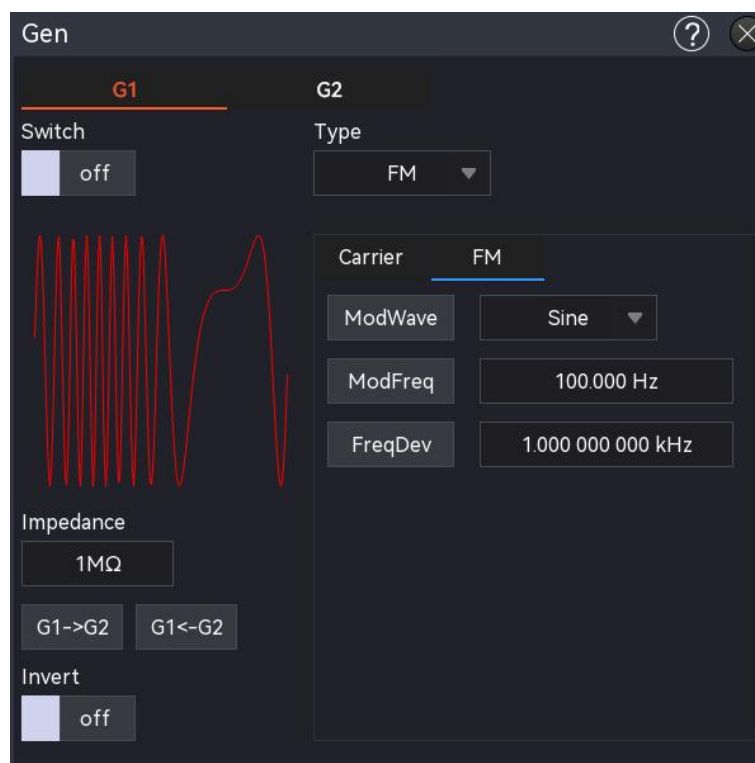

b. Select carrier wave

Click on the “Basic wave” to select sine, square, ramp or arbitrary wave.

■ Continuous wave setting



Once the carrier wave is selected, the parameter of the carrier wave should be set. For the carrier wave setting, refer to the section of [21.2 Basic Waveform](#).

c. Modulation wave setting



Modulation wave: sine, square, square, rising ramp, falling ramp, arbitrary, noise wave. The default is sine wave. Once FM is enabled, the modulation wave displays the sine wave. Click on the “Modulation wave” to change the modulation wave type. The modulation wave can refer to Table.

Modulation wave	Description
Square wave	Duty ratio is 50%
Rising ramp	Symmetry is 100%
Falling ramp	Symmetry is 0%
Arbitrary wave	Use automatic sampling to limit the arbitrary wave length at 4 kpts
Noise	White Gaussian noise

- Modulating frequency

The modulating frequency range is 2 mHz ~ 50 kHz(default 100 Hz). Once FM is enabled, the default modulating frequency 100 Hz will be displayed. Double-click on the “Modulating frequency” text field to pop up the numeric keyboard to set the modulating frequency. For the details on the use of the numeric keyboard, refer to the section of [5.8 Parameter Setting](#); or select the arrow key ,  below the Multipurpose rotary knob to move the cursor and the rotate the Multipurpose rotary knob change the modulating frequency.

- Frequency offset

The frequency offset indicates the offset of the frequency of the FM-modulated waveform relative to the carrier frequency, and the FM frequency offset can be set from the minimum DC to half the maximum current carrier bandwidth, and the default frequency offset is 100 Hz. Double-click on the “Frequency offset” text field to pop up the numeric keyboard to set the frequency offset. For the details on the use of the numeric keyboard, refer to the section of [5.8 Parameter Setting](#); or select the arrow key ,  below the Multipurpose rotary knob to move the cursor and the rotate the Multipurpose rotary knob change the frequency offset. The maximum of frequency offset is 12.5 MHz.

- Frequency offset \leq Carrier frequency, if the frequency offset is greater than the carrier frequency, the instrument will automatically limit the frequency offset to the maximum of the current carrier frequency.

- The sum of frequency offset and carrier frequency \leq Maximum frequency of the current carrier wave, if the frequency offset is set to an invalid value, the instrument will automatically limit the frequency offset to the maximum of the current carrier frequency.

(3) Output arbitrary wave

This oscilloscope has saved 200 arbitrary waves. For the built-in arbitrary wave list, refer to

Table 21-4.

- Enable arbitrary wave function

Click on the “Continuous” to select “Arbitrary wave” to enable this function. The instrument will output the arbitrary wave according to the current setting, as shown in the following figure.

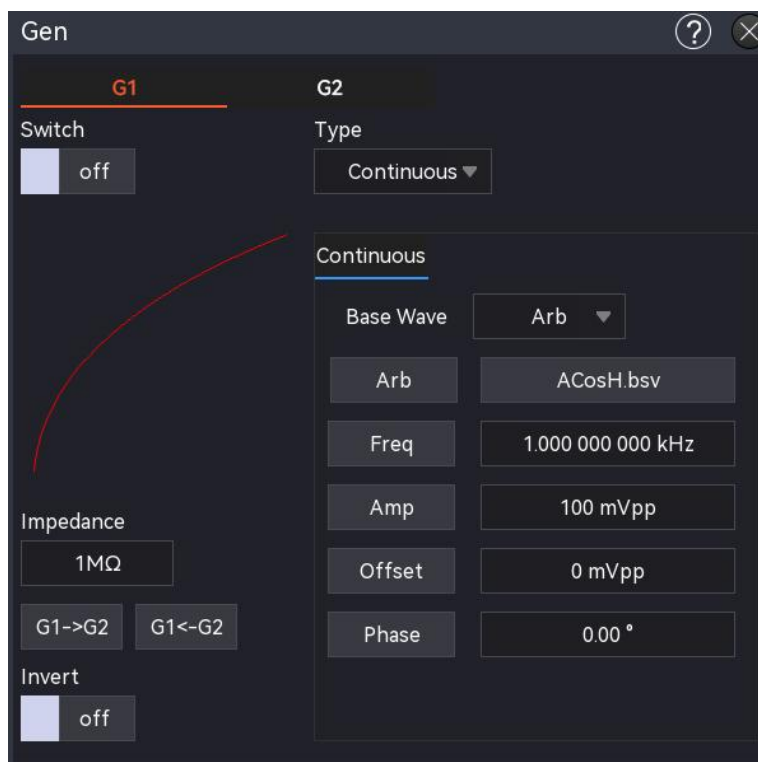

- Select arbitrary wave

The user can select the local built-in arbitrary wave or external arbitrary wave. Once the arbitrary wave is enabled, double-click on “Arbitrary wave” to select the required arbitrary wave

Built-in wave: load the saved waveform in Gen, which has common wave, math wave, engineering wave, window function, trigonometric function, as shown in Table.

Built-in Arbitrary Wave List Table

Type	Name	Description
Common function (15)	AbsSine	Absolute sine wave
	AbsSineHalf	Absolute half-sine wave
	AmpALT	Amplify sine wave
	AttALT	Attenuates sine wave
	Gaussian_monopulse	Gaussian monocycle
	GaussPulse	Gaussian pulse
	NegRamp	Falling ramp

	NPulse	N-Pulse signal
	PPulse	P-Pulse signal
	SineTra	TraSine wave signal
	SineVer	VerSine wave signal
	StairUD	Stair up and down
	StairDn	Stair down
	StairUp	Stair up
	Trapezia	Trapezoid
Engine (25)	BandLimited	Band limited signal
	BlaseiWave	Vibration of blasting "time-vibration velocity" curve
	Butterworth	Butterworth filter
	Chebyshev1	Chebyshev filter I
	Chebyshev2	Chebyshev filter II
	Combin	Combined function
	CPulse	C-Pulse signal
	CWPulse	CW pulse signal
	DampedOsc	Damped oscillation "time-offset" curve
	DualTone	Double audio signal
	Gamma	Gamma signal
	GateVibar	Gate self-oscillation signal
	LFMPulse	Linear FM pulse signal
	MCNoise	Mechanical noise
	Discharge	Ni-MH battery discharge curve
	Pahcur	Brushless DC motor current wave
	Quake	Quake wave
	Radar	Radar signal
	Ripple	Power ripple
	RoundHalf	Half round wave
	RoundsPM	RoundsPM wave
	StepResp	Step response signal
	SwingOsc	Swing oscillation - time curve
	TV	Television signal
Voice	Voice signal	
Maths	Airy	Airy function

(27)	Besselj	Besselj function I
	Besselk	Besselk function
	Bessely	Besselj function II
	Cauchy	Cauchy distribution
	Cubic	Cubic function
	Dirichlet	Dirichlet function
	Erf	Error function
	Erfc	Complementary error function
	ErfcInv	Inverse complementary error function
	ErfInv	Inverse error function
	ExpFall	Exponential falling function
	ExpRise	Exponential rising function
	Gammaln	Natural logarithm of Gamma function
	Gauss	Gaussian distribution (Normal distribution)
	HaverSine	Haversed sine
	Laguerre	Quartic Laguerre polynomial
	Laplace	Laplace distribution
	Legend	Quintic Legendre Polynomials
	Log10	Logarithm function based on 10
	LogNormal	Logarithmic normal distribution
	Lorentz	Lorentzian function
	Maxwell	Maxwell distribution
	Rayleigh	Rayleigh distribution
Versiera	Versiera	
Weibull	Weibull distribution	
ARB_X2	Square function	
SectMod (5)	AM	Sine wave amplitude modulation
	FM	Sine wave frequency modulation
	PFM	Pulse wave modulation
	PM	Sine wave phase modulation
	PWM	Pulse width modulation
Bioelect (6)	Cardiac	Electrocardio signal
	EOG	Electro-oculogram
	EEG	Electroencephalogram

	EMG	Electromyography
	Pulseilogram	Sphygmus curve of common people
	ResSpeed	Expiration rate curve of common people
Medical (4)	LFPulse	Low frequency pulse electrotherapy waveform
	Tens1	Transcutaneous electric nerve stimulation waveform 1
	Tens2	Transcutaneous electric nerve stimulation waveform 2
	Tens3	Transcutaneous electric nerve stimulation waveform 3
Automotive (17)	Ignition	Ignition waveform of automobile internal-combustion engine
	ISO16750-2 SP	Profile map of automobile starting oscillation
	ISO16750-2 Starting1	Automobile starting voltage waveform 1
	ISO16750-2 Starting2	Automobile starting voltage waveform 2
	ISO16750-2 Starting3	Automobile starting voltage waveform 3
	ISO16750-2 Starting4	Automobile starting voltage waveform 4
	ISO16750-2 VR	Operating voltage profile map of automobile under resetting
	ISO7637-2 TP1	Transient phenomena of automobile caused by power cut
	ISO7637-2 TP2A	Transient phenomena of automobile caused by inductance in wiring
	ISO7637-2 TP2B	Transient phenomena of automobile caused by turning off start-up changer
	ISO7637-2 TP3A	Transient phenomena of automobile caused by conversion
	ISO7637-2 TP3B	Transient phenomena of automobile caused by conversion
	ISO7637-2 TP4	Working profile map of automobile under start-up

	ISO7637-2 TP5A	Transient phenomena of automobile caused by power cut of battery
	ISO7637-2 TP5B	Transient phenomena of automobile caused by power cut of battery
	SCR	SCR (sintering temperature distribution)
	Surge	Surge signal
Trigonome (21)	CosH	Hyperbolic cosine
	CosInt	Cosine integral
	Cot	Cotangent function
	CotHCon	Concave hyperbolic cotangent
	CotHPro	Convex hyperbolic cotangent
	CscCon	Concave cosine
	CscPro	Convex cosine
	CotH	Hyperbolic cotangent
	CscHCon	Concave hyperbolic cosecant
	CscHPro	Convex hyperbolic cosecant
	RecipCon	Reciprocal of the depression
	RecipPro	Reciprocal of the projection
	SecCon	The secant of the depression
	SecPro	The secant of the projection
	SecH	Hyperbolic secant
	Sinc	Sinc function
	SinH	Cotangent function
	SinInt	Sine integral
	Sqrt	Square root function
	Tan	Tangent function
TanH	Hyperbolic tangent	
AntiTrigonome (16)	ACosH	Arc-cosine function
	ACotCon	Arc- hyperbolic cosine function
	ACotPro	Arc- hyperbolic cosine function
	ACotHCon	Convex arc cotangent function
	ACotHPro	Concave arc- hyperbolic cosine function
	ACscCon	Convex arc- hyperbolic cosine function

	ACscPro	Concave arc cosecant function
	ACscHCon	Convex arc cosecant function
	ACscHPro	Concave arc hyperbolic cosecant function
	ASecCon	Convex arc hyperbolic cosecant function
	ASecPro	Concave arc secant function
	ASecH	Convex arc secant function
	ASin	Arc hyperbolic secant function
	ASinH	Arcsin function
	ATan	Arc hyperbolic sine function
	ATanH	Arctan function
Noise (6)	NoiseBlue	Blue noise
	NoiseBrown	Brown noise (red noise)
	NoiseGray	Gray noise
	NoisePink	Pink noise
	NoisePurple	Purple noise
	Noisewhite	White noise
Window function (17)	Bartlett	Bartlett window
	BarthannWin	Amended Bartlett window
	Blackman	Blackman window
	BlackmanH	BlackmanH window
	BohmanWin	Bohman window
	Boxcar	Rectangle window
	ChebWin	Chebyshev window
	GaussWin	Gaussian window
	FlattopWin	Flat-top window
	Hamming	Hamming window
	Hanning	Hanning window
	Kaiser	Kaiser window
	NuttallWin	The minimum of four Blackman Harris window
	ParzenWin	Parzen window
	TaylorWin	Taylor window
	Triang	Quarter window (Fejer window)
	TukeyWin	Tukey window

Complex Wavelets (7)	Complex Frequency B-spline	Complex Frequency B-spline function
	Complex Gaussian	Complex Gaussian function
	Complex Morlet	Complex Morlet wavelet
	Complex Shannon	Complex Shannon function
	Mexican hat	Mexican hat wavelet
	Meyer	Meyer wavelet
	Morlet	Morlet wavelet
Other (34)	ABA_1_1	
	ABA_1_2	
	ALT_03	
	ALT_04	
	ALT_05	
	AUDIO	
	COIL_2_1	
	COIL_2_2	
	DC_04	
	ECT_1_2	
	EGR_2	
	EGR_3_2	
	EST_03_2	
	IAC_1_1	
	INJ_1_1	
	INJ_2	
	INJ_3	
	INJ_4	
	INJ_5_6	
	INJ_7	
	KS_1_1	
	MAF_1_1	
	MAF_1_2	
	MAF_5_3	
MAP_1_1		
MAP_1_2		
MC_3		

	Mexican hat	Mexican hat wavelet
	O2PROPA1	
	O2PROPA2	
	O2SNAP	
	STAR02_1	
	TPS_1_1	
	TPS_1_2	

24. APP

Press the **APP** sofkey on the front panel to enter the toolbar setting menu, to edit/delete/order the shortcut menu icon.

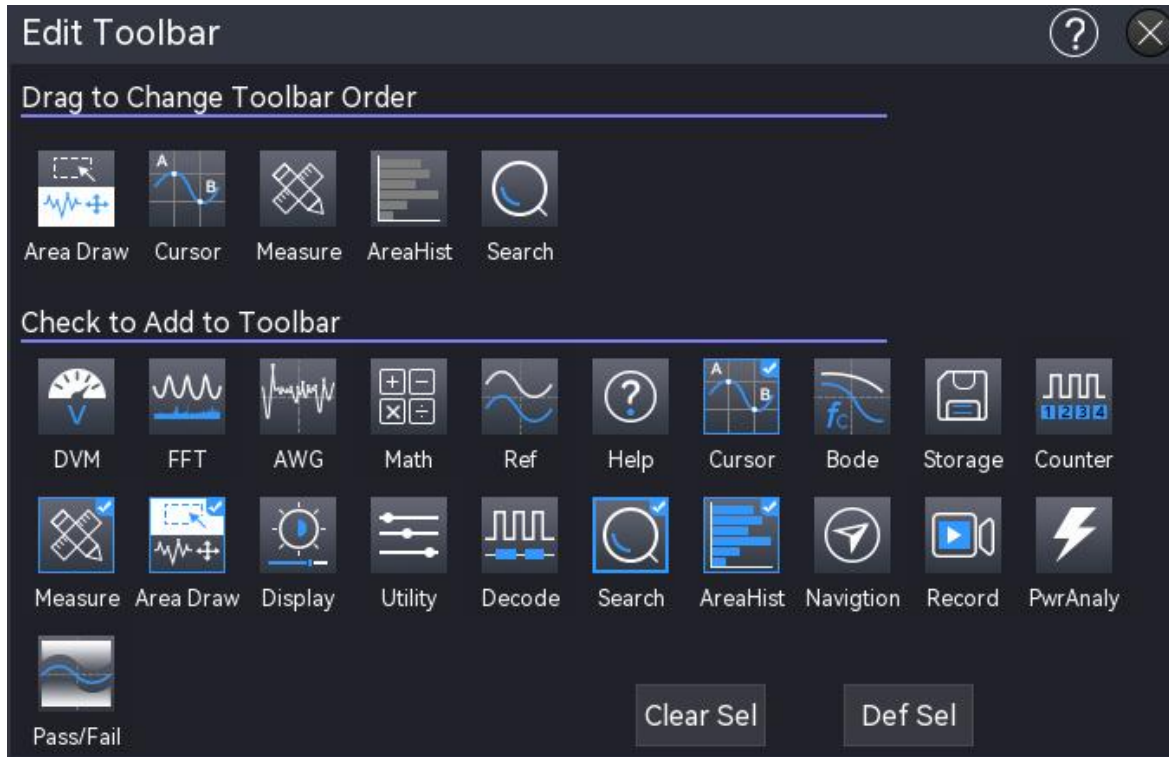

(1) Add

The toolbar contains all the function icon that can be added to the toolbar. Click to select the function to be added to the toolbar, click it again to deselect. The selected icon displays \checkmark in the top right corner. A maximum of 9 function icons can be added to the tool bar.

(2) Sequence

In the toolbar pop-up box, the function menu added to the toolbar can be adjusted by dragging the corresponding icons left and right, to adjust the order of the icons displayed in the toolbar.

(3) Default setting

By default, MSO2000X/3000X toolbar displays 5 icons: Region drawing, Cursor, Measurement, Region Histogram, Search.





(4) Delete

Delete all the menus from the toolbar.

25. Regional Histogram

The regional histogram provides a probabilistic count of the vertical and horizontal direction of the waveform, showing the number of times the waveform crosses (or triggers) rows and columns in a user-defined window, which can help the user quickly analyse potential anomalies in the signal. The regional histogram is divided into vertical and horizontal histograms. The window is divided into several rows and columns.

The regional histogram can be entered by the following steps.

- Click the Home icon  on the top right corner, and select the regional histogram icon  to open the regional histogram, and the icon  is highlighted.
- If the regional histogram is added to the toolbar, click the regional histogram icon  to open the regional histogram, and the icon  is highlighted.

When the regional histogram is opened, click on the regional histogram icon  to close it.

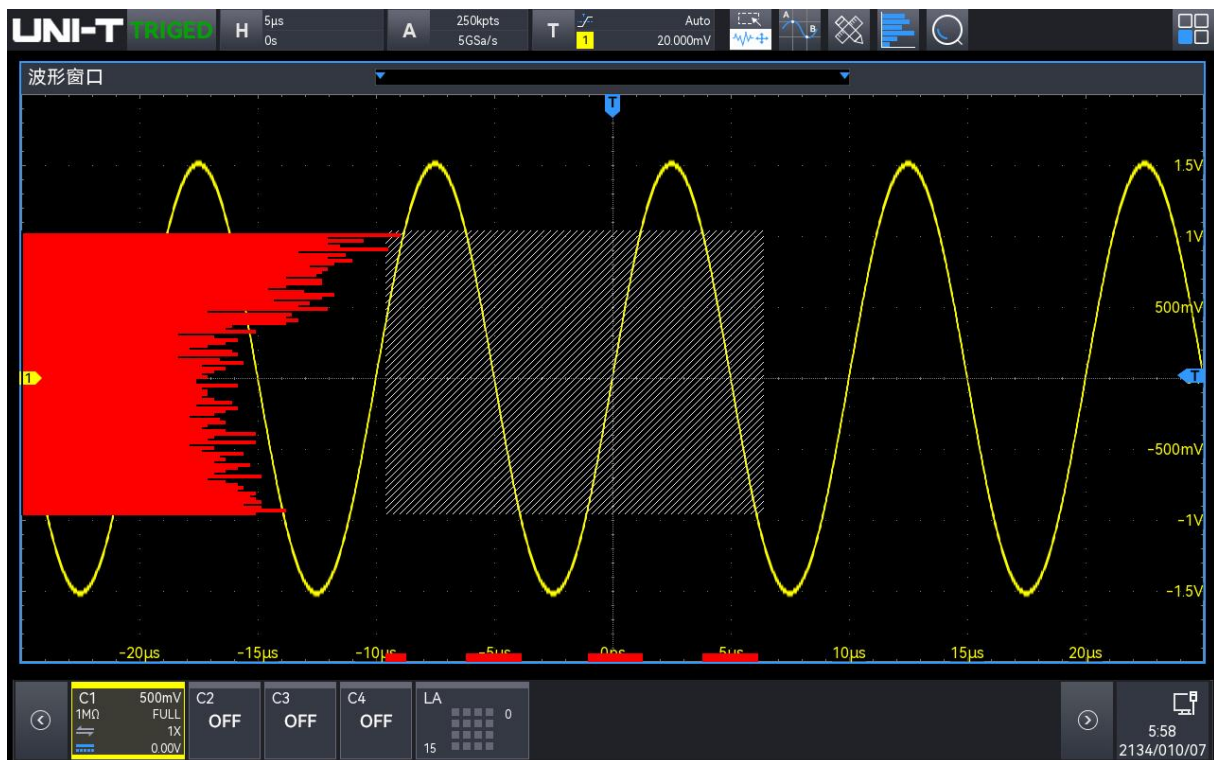

The visual component of the histogram is the bar graph on the screen. The graph is displayed to the left of the grid area of the vertical waveform histogram and at the bottom of the grid area of the horizontal waveform histogram. As waveforms are acquired and displayed or measurements are made, the size of the bar graph changes to show the peaks of the trigger number at the specified histogram size.

The measurement window of regional histogram can be set by the following steps.

- The measuring channel in the regional histogram is the currently activated logic channel, switch the activated channel that is to switch the measuring channel of the regional histogram.
- Click on the measuring window of the regional histogram, and drag the histogram to move its position.
- Select the boundary of the histogram (4 boundaries) and drag to change the measuring window size.

26. Help System

The help system describes the function key (include menu key) on the front panel.

The help system can be entered by the following steps.

- In Home menu, click on the help icon “?” to open the help menu.
- In each function menu popups, click on the help icon “?” on the top right to open the relevant help menu.

The help screen is divided into two parts, the left side is ‘Help Options’ and the right side is ‘Help Display Area’. By selecting a help option, the user can see all the help contents under that option on the right.

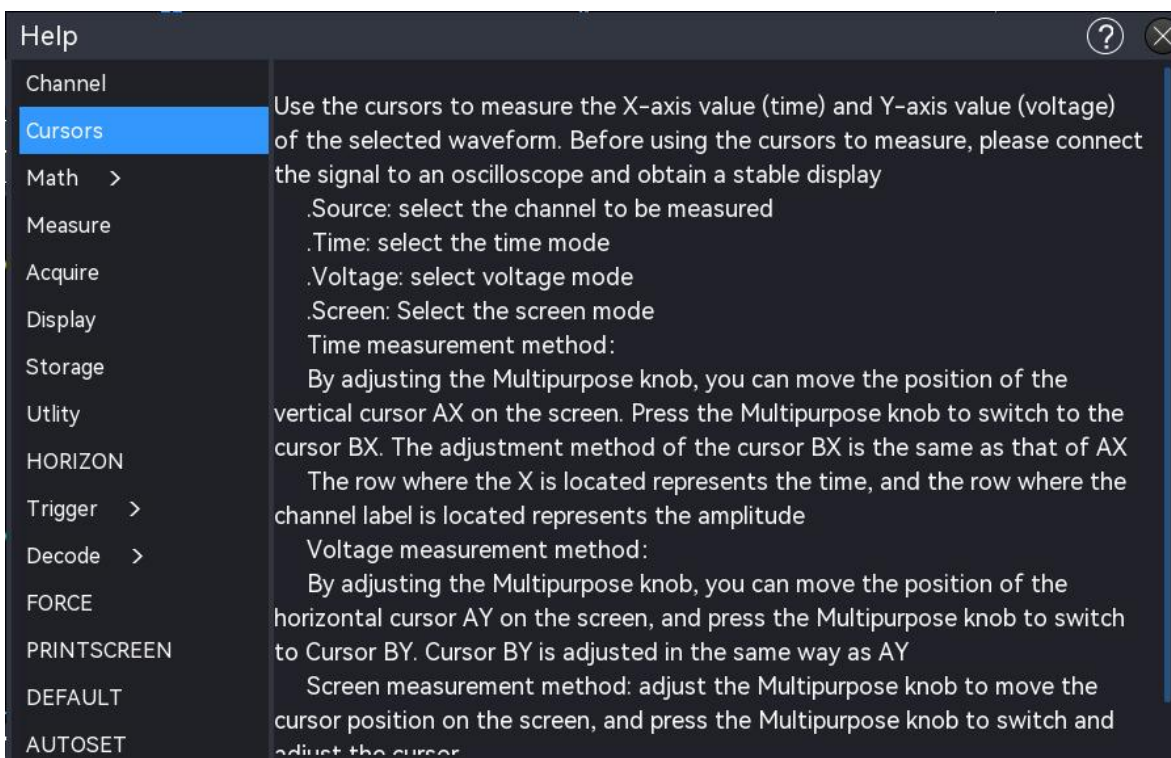

27. Notification Setting

Click on the notification area on the bottom of the screen to enter the time setting, WIFI setting and file browser setting.



27.1. Time Setting

Click on the time at the bottom of the screen to open the “Time setting” pop-up box.

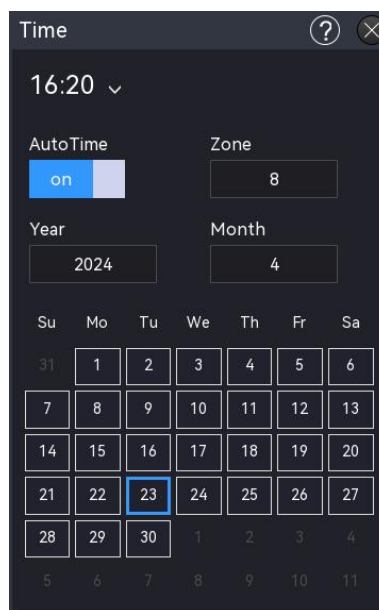

(1) Automatic set time

Click on the “Automatic set time” to switch on/off the setting. The automatic set time can only be synchronized to Beijing time when the oscilloscope is connected to the network. If it is not connected to the network, the time will be based on the current set time.

(2) Time zone

Click on the “Time zone” text field, and rotate the Multipurpose rotary knob on the front panel to change the time zone; or double-click on the “Time zone” text field to pop up the numeric keyboard to enter the time zone. For the details on the use of the numeric keyboard, refer to the section of [5.8 Parameter Setting](#). The time zone can be set to -11~12.

(3) Month

Click on the “Month” text field, and rotate the Multipurpose rotary knob on the front panel to change the month; or double-click on the “Month” text field to pop up the numeric keyboard to enter the month. For the details on the use of the numeric keyboard, refer to the section of [5.8 Parameter Setting](#). The month can be set to 1~12.

(4) Date

Click on the “Date” at the bottom of the screen to set the date, the selected date is displayed in blue.

(5) Time

Click on the “Time” to scroll the two dial plates to set the current time, or click and scroll the hour (on the left), minute (on the right) to set the current time. Click on the blank area to complete the time setting.

27.2. Wi-Fi Connection

Click on the network icon on the bottom of the screen to open the “Network setting” box, and to connect Wi-Fi.

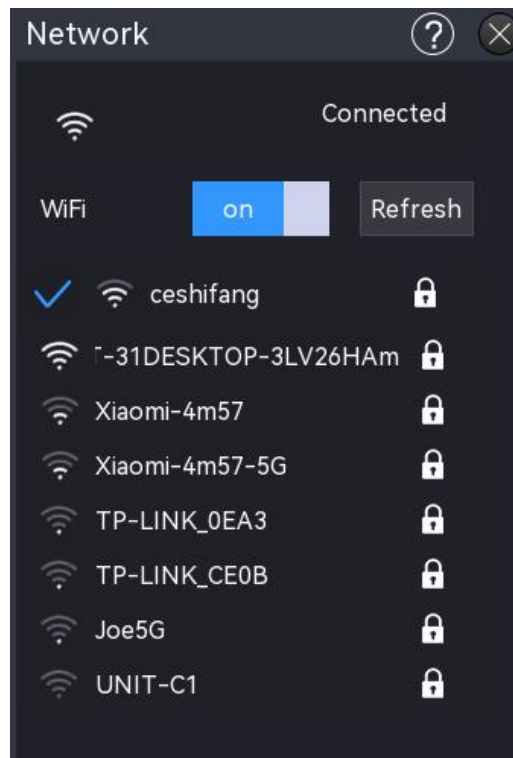

(1) WIFI switch

Click on the “Wi-Fi switch” to switch Wi-Fi ON/OFF.

- ON: Automatically search nearby available Wi-Fi and display it in a list; if a Wi-Fi is connected and remembers the password, it can be automatically connect when re-connected.
- OFF: Close the Wi-Fi list and disconnect the Wi-Fi.

(2) WIFI connection

If Wi-Fi is enabled, click on the Wi-Fi name in the list to pop up the text box, and then enter the Wi-Fi password, set Wi-Fi remember, connect/disconnect Wi-Fi.

- WiFi password: Double click on the “WiFi password” text field to pop up the virtual keyboard to enter the password. For details on the use of the virtual keyboard, refer to the section of [5.8 Parameter Setting-Input Character String](#).
- Password remember: Click to tick “password remember” to save the current password and use it the next time.
- Connection: Click on the “Connection” to connect a Wi-Fi.
- Cancel: Click on the “Cancel” to disconnect a Wi-Fi.

27.3. File Browser

Click on the USB icon on the bottom right to directly enter the file browser. For the details on the use of the file browser, refer to the section of [14.7 File Browser](#).

28. Additional Function Key

- [Automatic Setting](#)
- [Run/Stop](#)
- [Factory Setting](#)

28.1. Automatic Setting

Automatic settings will choose appropriate time base scale, amplitude scale and trigger parameter according to the input signal so that the waveform will automatically display on the screen. Press the **Auto** key on the front panel to enable automatic settings.

Automatic setting only applies to the following conditions.

- Automatic setting is only suitable for simple single frequency signal. It is impossible to achieve effective automatic setting for complex combination waves.
- The measured signal frequency is not less than 10 Hz, and the amplitude is not less than 12 mVpp; the duty cycle of square wave is greater than 5%.

28.2. Run/Stop

Use the **Run/Stop** key on the front panel to set. If the green light is on after the key is pressed, it indicates the RUN state. If the red light is on after the key is pressed, it is the STOP state.

In the running state, the oscilloscope is continuously acquiring waveform and the upper part of the screen shows "AUTO"; in the stop state, the oscilloscope stops the acquisition and the upper part of the screen shows "STOP". Press the **Run/Stop** key to switch the waveform sampling between the run and stop states.

28.3. Factory Setting

Press the **Default** key on the front panel, the oscilloscope can quickly restore to factory setting. The factory settings of MSO2000X/3000X series mixed signal oscilloscope are as shown in Table.

System	Function	Factory Setting
Vertical System	CH1	200 mV/div
	Vertical offset	0 (vertical midpoint)
	Zero position	0 (vertical midpoint)
	Coupling	DC
	Bandwidth limit	Full bandwidth
	Volts/div scale	Coarse tuning
	Deflection factor of fine tuning	0
	Probe	1×
	Reversed phase	OFF
	Unit	V
	CH2, CH3, CH4	OFF
	MATH, REF, Digital	OFF
Horizontal System	Extension window	OFF
	Split screen	OFF
	Time base	Extension
	Mode	YT
	XY-CH	CH1-CH2
	Horizontal time base	1 μ s/div
	Horizontal offset	0 (horizontal midpoint)
Trigger System	Trigger mode	Edge
	Trigger polarity1	Rising edge
	Coupling mode	DC
	Trigger condition	Greater than
	Lower limit of time	3.2 ns
	Upper limit of time	6.4 ns
	Edge count	1
	Trigger line L position	0
	Trigger line H position	0
	Trigger mode	Auto
	Trigger holdoff	80 ns
	Source 1	CH1
	Source 2	CH1
Trigger polarity 2	Rising edge	

	Video trigger format	PAL
	Video trigger synchronization	EVEN
	Video trigger specified line	1
Display	Format	Vector
	Grid display	Full display
	Transparence of pop-up window	50%
	Backlight brightness	50%
	Persistence	Minimum
	Temperature color	OFF
	Grid brightness	50%
	Waveform brightness	50%
MATH	Type	MATH
	Source 1	CH1
	Operator	+
	Source 2	CH1
	Probe multiplying ratio	x1
	FFT window function	Hanning
	FFT unit	dB
	FFT count	Auto
	FFT mark mode	OFF
	FFT split screen	OFF
	FFT mark threshold	0
	Digital filter	Low pass
Measurement	Main source of measurement	CH1
	All parameter measurement	OFF
	Custom parameter	OFF
	Statistics	OFF
	Slave source	CH1
	Indicator enable	OFF
	Indicator	Maximum
Pass/Fail Test	Output	Fail
	Source	CH1
	Display	OFF
	Stop type	Fail time

	Stop condition	Greater than or equal to
	Threshold	1
	Waveform reference template	CH1
	Horizontal position	5
	Vertical position	5
Bus Decoding	Decoding type	RS232
	Bus state	OFF
	Display format	Hexadecimal
	Event list	OFF
	Bus position	0
	RS232 source	CH1
	RS232 polarity	Positive
	RS232 bitrate	100
	RS232 bit width	5 bits
	RS232 bit sequence	LSB
	RS232 stop bit	1
	RS232 parity bit	None
	RS232 trigger condition	Start frame
	RS232 data	0
	I2C SCL	CH1
	I2C SDA	CH1
	I2C address bit width	7 bits
	I2C address	0
	I2C address mask	0
	I2C operation direction	Read
	I2C trigger condition	Start
	I2C byte length	1
	I2C data	0
	I2C mask	0
	SPI CS	CH1
	SPI CLK	CH1
	SPI MOSI	CH1
SPI MISO	CH1	
SPI CS polarity	Positive	

	SPI CLK polarity	Positive
	SPI MOSI polarity	Positive
	SPI MISO polarity	Positive
	SPI bit sequence	MSB
	SPI bit width	4 bits
	SPI idle time	96 ns
	SPI frame length	1
	SPI MOSI data	0
	SPI MOSI mask	0
Digital	Low 8 channel threshold (custom)	0
	High 8 channel threshold (custom)	0
	Bus 1 jitter proof time	0
	Bus 2 jitter proof time	0
Other System	Counter	OFF
	Square wave output	1 kHz
	Synchronized output	OFF
	SCPI port	USB
	DHCP	Manual
	Language	Current language
	Sampling mode	Normal
	Average sampling time	2
	Storage depth	Auto
	Cursor type	OFF
	Cursor mode	Independent
	Horizontal unit of cursor	Second
	Cursor channel	CH1
	Automatic set channel	Autoset
	Automatic set sampling	Autoset
	Automatic set trigger	Autoset
	Automatic set signal	Autoset
	Current channel	CH1
	Digital	OFF
	RUN/STOP	RUN

29. System Prompt and Troubleshooting

- [System Prompt](#)
- [Troubleshooting](#)

29.1. System Prompt

This chapter is to describe the system prompt, the detailed explanation as shown in Table.

Adjusting is up to extremity!	It is prompt that the adjusting is up to extremity in the current status. It cannot be adjust. It will be prompt when vertical scale rotary knob, time base knob, horizontal displacement, vertical displacement and trigger level, trigger time is up to extremity.
There is no valid data!	It will be prompt when saving waveform.
Warning! It will clear all saved waveforms and settings.	It will be prompt when using clear function.
Forbidden function!	It will be prompt if open event list when bus is disabled; switch extend serial port in roll mode.
Fail to create a template!	It will be prompt when the selected reference waveform is not opened in Pass/Fail template. It will be prompt when turn on operation to run Pass/Fail test.
There is no record data!	It will be prompt if operating play and stop function when there is no record data.
Attention! Pass/Fail function is invalid when the scanning is turned on.	It will be prompt when allow to test function is enabled.
I/O operation is failed!	It will be prompt when failed to save Bode data; failed to save waveform.
Attention! It will restore the system to factory setting.	It will be prompt when using the default function.
Storage is failed, please format USB to FAT.	It will be prompt if using USB which is not FAT format to save data.
No USB has detected, please insert USB device!	It will be prompt when USB is not connected.
Remove all input signals.	It will be prompt when using analog channel

	calibration and digital calibration.
Auto-calibration is completed!	It will be prompt when auto-calibration is completed.
Channel has no signal!	It will be prompt when channel is no signal.
The record function is invalid in Roll mode!	It will be prompt when the oscilloscope operates recording waveform in Roll mode.
There is no parameter can be use, please select user-defined measurement parameter!	It will be prompt if there is no user-defined parameter when turn on measurement statics.
Data storage is successful!	It will be prompt when save waveform, setting file, arbitrary wave is completed.
Data storage is failed!	It will be prompt when save waveform, setting file, arbitrary wave is failed.
Loading file is successful!	It will be prompt when recall saved setting or waveform and it appeared in storage.
Loading file is failed!	It will be prompt if it not appeared in storage when recall saved setting or waveform.
Invalid expression!	It will be prompt when MATH advanced operation and application expression is invalid.
Screenshot is successful!	It will be prompt when save picture or use PrtSc to save picture is completed.
The update path was not fund!	It will be prompt if USB is not insert to provide the update file when the instrument is in updating.
The update file was not fund!	It will be prompt if USB cannot provide the update file when the instrument is in updating.
The filename cannot be empty!	It will be prompt if the filename is empty when save waveform, setting file, arbitrary wave, recording waveform.
Language package is error, please check the language package!	It will be prompt when language package occurs error.
Clear data is successful!	It will be prompt when clear data is finished.
The program is in updating, do not reboot!	It will be prompt when the program is in updating.
It cannot canceled during update!	It will be prompt if press cancel function when the program is in updating.
Update is failed, please check the update package and version!	It will be prompt if the update program is not complete when the program is in updating.

Update is completed, reboot system now?	It will be prompt when the program is upgraded.
It is in recording, please exit the recording!	It will be prompt if press other function key when in recording waveform.
In XY mode, this function cannot be use!	It will be prompt when open MATH, REF, Digital, DECODE function in XY mode.
Start to update?	It will be prompt when select the update file to upgrade.
The channel is not open!	It will be prompt if the selected channel is not opened in cursor measurement, Pass/Fail template, channel waveform storage, arbitrary waveform storage function.
Turn on allow to test!	It will be prompt when allow to test function is disabled.
Waveform reference channel is not open, there is no valid data!	It will be prompt if REF is not loading adjusting horizontal or vertical when waveform reference is select REF in Pass/Fail test.
It's not allow to test in XY and the main window mode !	It will be prompt when Pass/Fail test and XY mode is enabled.
Turn off scanning!	It will be prompt if press other key when it in scanning.
There is no opened channel, please turn on channel to record!	It will be prompt if all analog channel is turned off when in recording waveform.
In Multi-Scopes, Digital is forbidden!	It will be prompt when turn on Multi-Scopes function and then open Digital.
In FFT split screen mode, this function is invalid!	It will be prompt when using Pass/Fail test, bode diagram, reload waveform, Digital function in FFT split screen, waterfall curve mode.
In FFT split screen mode, Pass/Fail test is forbidden!	It will be prompt when turn on Pass/Fail test function and then open FFT split screen.
The file list is empty!	It will be prompt when if the filename is empty when reload reference waveform, the setting file and bode diagram.
Auto-calibration is canceled!	It will be prompt if press MENU key to cancel auto-calibration when in auto-calibration.
Restored to factory setting, internet parameter is not change!	It will be prompt when SCPI is connect the internet to send factory setting command.

Shunt down, please wait...	It will be prompt when the oscilloscope is shutting down.
Turn off quick record and set record interval!	It will be prompt when set the time interval in quick record.
No correct license is detected. Confirm the purchase and try again!	It will be prompt if there is no correct license when insert USB to activate the optional.
Activation is successful!	It will be prompt when activation license is selected in USB.
This function is not activated, please purchase activation code!	It will be prompt when select the optional after the trail is ended.
The function is in trail. If need to use it in the long run, please purchase activation code!	It will be prompt if select the optional when it in trail.

29.2. Troubleshooting

- (1) If the oscilloscope remains black screen without any display when press the power soft key.
 - a. Check if the power plug is properly connected and the power supply is normal.
 - b. Check if the power switch is turned on. If the power switch is turned on, the power soft key on the front panel should be green. When the power soft key is enabled, the power soft key should be blue and the oscilloscope will make active sound. There should be a normal relay rattle when the soft switch key is pressed.
 - c. If the relay has sound, it indicates that the oscilloscope is normal boot-up. Press the Default key and press the "Yes" key, if the oscilloscope returns to normal, indicating that the backlight brightness is set too low.
 - d. Restart the oscilloscope after completing the above steps.
 - e. If the product still does not work properly, contact the UNI-T Service Center for assistance.
- (2) After signal acquisition, the waveform of the signal does not appear on the screen.
 - a. Check whether probe and DUT are connected properly.
 - b. Check whether the signal output channel is open.
 - c. Check whether the signal connecting line is connect to analog channel.
 - d. Check whether the signal source has DC offset.
 - e. Plug out the connected signal, to check whether the base line is within the screen range (If not, please perform self-calibration).
 - f. If the product still does not work properly, contact the UNI-T Service Center for assistance.

- (3) The measured voltage amplitude value is 10 times larger or 10 times smaller than the actual value.

Check whether the channel probe attenuation coefficient settings are consistent with the used probe attenuation rate.
- (4) There is a waveform display but not stable.
 - a. Check the trigger settings in trigger menu whether is consistent with the actual signal input channel.
 - b. Check the trigger type: the general signals should use “Edge” trigger. The waveform can only be displayed stably if the trigger mode is set correctly.
 - c. Try to change trigger coupling to HF rejection or LF rejection, to filter out the high-frequency or low-frequency noise that interfere the trigger.
- (5) No waveform display after press the **Run/Stop** key.
 - a. Check whether the trigger mode is in normal or single and whether the trigger level is exceed the waveform range.
 - b. If the trigger mode is in normal or single and the trigger level is in the center, set the trigger mode to **Auto**.
 - c. Press the **Auto** key to automatically complete the above settings.
- (6) Waveform refresh is very slow.
 - a. Check whether the acquisition method is average and the average times are large.
 - b. Check whether the storage depth is maximum
 - c. Check whether the trigger holdoff is large.
 - d. Check whether it is normal trigger and is slow timebase
 - e. All of the above will lead to slow waveform refresh, it is recommended to restore the factory settings, then the waveform can be refreshed normally.

30. Appendix

30.1. Appendix A Maintenance and Cleaning

(1) General Maintenance

Keep the instrument away from the direct sunlight.

Caution: Keep sprays, liquids and solvents away from the instrument or probe to avoid damaging the instrument or probe.

(2) Cleaning

Check the instrument frequently according to the operating condition. Follow these steps to clean the external surface of the instrument.

Please use a soft cloth to wipe the dust outside the instrument.

When cleaning the LCD screen, please pay attention and protect the transparent LCD screen.

When cleaning the dust screen, use a screwdriver to remove the screws of the dust cover and then remove the dust screen. After cleaning, install the dust screen in sequence.

Please disconnect the power supply, then wipe the instrument with a damp but not dripping soft cloth. Do not use any abrasive chemical cleaning agent on the instrument or probes.

Warning: Please confirm that the instrument is completely dry before use, to avoid electrical shorts or even personal injury caused by moisture.

30.2. Appendix B Contact Us

If the use of this product has caused any inconvenience, if you in mainland China you can contact UNI-T company directly.

Service support: 8am to 5.30pm (UTC+8), Monday to Friday or via email.

For product support outside mainland China, please contact your local UNI-T distributor or sales center. Many UNI-T products have the option of extending the warranty and calibration period, please contact your local UNI-T dealer or sales center.