

REED

Model MS2301

Ground Resistance Clamp Meter



Instruction Manual

[www reedinstruments.com](http://www.reedinstruments.com)

Table of Contents

Safety	3
Maintenance.....	3
Features.....	4
Specifications	4-5
Instrument Description/Function	6-7
LCD Display.....	8-9
Operating Instructions.....	10-14
<i>On/Off</i>	10
<i>Ground Resistance Measurement</i>	10
<i>Schematics of Measurement</i>	11-12
<i>Current Measurement</i>	12
<i>Alarm Operation</i>	13
<i>Memory</i>	13-14
<i>Special Functions</i>	14
Battery Replacement.....	15
Field Applications	16-18

For service on this or any other REED product or for information on other REED products, contact REED Instruments at info@reedinstruments.com

Safety

To ensure safe operation and service of this meter, follow these instructions:

- Before use take note that the metal objects and the conductors of this meter can be very dangerous
- When testing the meter, pay extra attention to safety to prevent shock and arc blast injury where hazardous live conductors are exposed
- Before each use, inspect the meter; look for cracks or missing portions of the housing or output cable insulation as well as loose or weakened components, pay particular attention to the insulation surrounding the jaws
- Operating limits of Unit are as indicated on the back of the Meter (600V in Category III)
- Use extreme caution when working around bare conductors or bus-bars, contact with the conductor could result in electric shock
- Before turning the instrument on, press the trigger several times to ensure the jaw is closing correctly
- When the meter is on and auto-calibrating, do not open the jaw or hook it around any conductor

Maintenance

- Keep the surfaces of the jaw clean, any dirt can cause malfunctions
- Use a soft damp cloth to clean the jaw faces, do not use abrasives, solvents or alcohol
- Avoid any shocks to the meter, especially to the jaw faces
- After each measurement, press the HOLD button to save battery power
- Remove the batteries from the meter if not to be used for a prolonged period of time

Features

This ground resistance clamp meter is more advanced than the traditional testers.

- Supplementary leads and other accessories are not required
- Measure ground resistance safely and quickly by simply clamping the ground line
- Measure current as well as resistance
- Resolution of 0.001Ω
- Accuracy of $\pm 0.01\Omega$ for low resistance measurements
- Stores up to 99 resistance measurements
- Resistance limit alarm function
- User selectable alarm threshold from 1 to 100Ω
- Measures leakage current to 1mA and neutral current to 20A
- 1 second sampling time • Display "Hold" • Auto-ranging
- Doubly insulated conductor clamp
- Large jaws open to 45 x 32mm

Specifications









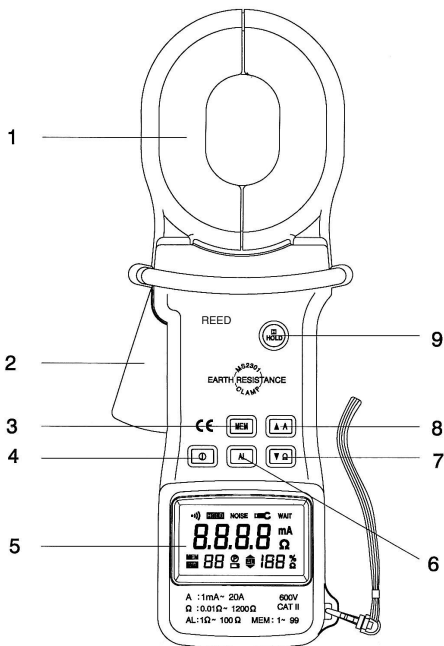





	Range	Accuracy	Resolution
Resistance:	0.01-0.999 Ω	$\pm(1.5\% + 0.01\Omega)$	0.001 Ω
	1-9.99 Ω	$\pm(1.5\% + 0.1\Omega)$	0.01 Ω
	10-99.9 Ω	$\pm(2.0\% + 0.3\Omega)$	0.1 Ω
	100-199.9 Ω	$\pm(3.0\% + 1\Omega)$	1 Ω
	200-400 Ω	$\pm(6.0\% + 5\Omega)$	5 Ω
	400-600 Ω	$\pm(10\% + 10\Omega)$	10 Ω
	600-1200 Ω	approx. 20%	20 Ω
Current:	100mA	$\pm(2.5\% + 1mA)$	0.1mA
	300mA	$\pm(2.5\% + 2mA)$	0.3mA
	1A	$\pm(2.5\% + 0.003A)$	0.001A
	3A	$\pm(2.5\% + 0.01A)$	0.003A
	10A	$\pm(2.5\% + 0.03A)$	0.01A
	20A	$\pm(2.5\% + 0.05A)$	0.03A

Testing Conditions:

Temperature:	23°C ±3°C
Humidity:	50% RH ±10%
Battery Voltage:	>7V
External Magnetic Field:	<40A/m
External Electric Field:	<1 V/m
Testing Frequency of Current:	45 Hz to 65 Hz
Operating Temperature:	-10°C to 50°C (14°F to 122°F)
Storage Temperature:	-20°C to 60°C (-4°F to 140°F)
Max. Test Voltage:	3700V
Overload Protection:	20A rms
Electric Clearance:	6.5mm (IEC1010 double insulation, CAT II 600V)
Electric Shock:	IEC1010-1
Display:	4-digit LCD, 9999 counts
Power Supply:	1 x 9V battery
Battery Life:	10 to 12 hours of continuous use
Dimensions:	54 x 104 x 276mm
Weight:	1050g (with battery)
Includes:	3 resistance calibration loops (1Ω, 5Ω, and 10Ω), hard carrying case, batteries, and display cleaning wipe

Instrument Description/Function





Description	Button	Function	
1	Jaws		
2	Trigger		
3	MEM Button		Select/Set Memory Mode
4	Power Button		ON/OFF/EXIT Set Mode
5	LCD Display		
6	AL Button		Select Alarm Mode
7	ARROW Ω Button		Ω Measurement/Alarm Value Decrease/Record Number Select
8	ARROW A Button		A Measurement/Alarm Value Increase/Record Number Select
9	HOLD Button		HOLD Display
Additional Functions	 + 	Switch Buzzer ON/OFF	
	 + 	Set Alarm Value	
	 + 	Auto Power Off Function Set	
	 + 	Read Saved Measurement Value	
	 + 	Reset Memory to Zero	

LCD Display

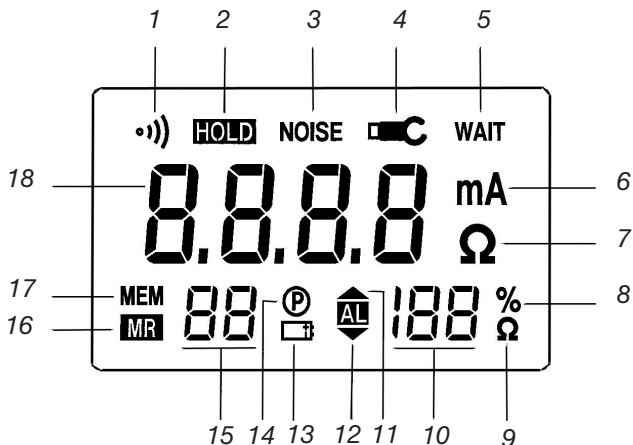
Note: When the meter is turned on, it performs a rapid auto-test of the entire display. All the symbols will show in the display for a short time.



Symbol	Description	Function
1		Buzzer The buzzer is ON
2	HOLD	Hold Holds the last measurement
3	NOISE	Interference Symbol Indicates that the current in the grounding loop has been disturbed. The resistance measurement can be affected
4		Clamp Indicates that the jaws are not closed properly, the meter will not take measurements

continued ...





5	WAIT	Wait	Indicates that the meter is auto-calibrating
6	mA	Current	Current unit of measure
7	Ω	Resistance	Resistance unit of measure
8	%	Battery Life	Indicates the percentage of battery power remaining
9	Ω	Alarm Threshold	Indicates the resistance value of the unit
10	188	Value	Indicates the value of the battery life or alarm threshold
11	AL	High Alarm	
12	AL	Low Alarm	
13		Low Battery	Indicates the battery power is running low and the batteries need to be replaced
14	P	Auto Power Off	
15	88	Records	Indicates the number of records
16	MR	Read Memory Mode	
17	MEM	Save in Memory Mode	
18	8.8.8.8	4 Digit Reading	

Operating Instructions

ON/OFF

The **ⓘ** button switches the meter on and off. Press the **ⓘ** button once to turn the meter on and then hold the **ⓘ** button for two seconds to turn the meter off. Once the meter is on, it begins to auto-calibrate. While it's calibrating, the display will go from CAL 9 to CAL 0. Wait until the meter has finished before pressing anything or opening the jaws. Once the calibration is completed, the meter will return to the measurement mode that was last used. If it was in resistance mode, the LCD will display the primary resistance measured value.

Ground Resistance Measurement

1. After turning the meter on, you can press the  button to configure for resistance measurement mode.
2. Hook the jaw around the leads or electrodes to be tested.
3. If the  and  symbols appear on the display, this indicates that the jaw is not closed properly. Press the trigger several times to close the jaw properly. Once the  symbol disappears, the meter returns to the usual measurement mode.
4. Read the measurement value on the display.
5. If the **NOISE** symbol appears on the display, indicates that the current in the grounding loop has been disturbed. The resistance measurement can be affected.

continued ...

Schematics of Measurement

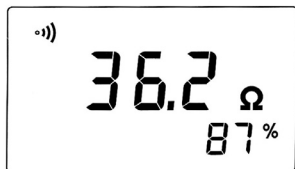

Buzzer ON.

A loop ground resistance of 36.2Ω . The battery life is at 87%.



Buzzer ON.

A loop ground resistance of 68.7Ω . The ground resistance value is above the high alarm threshold of 50Ω , a beep will sound.

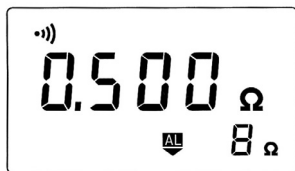

Buzzer ON.

A loop ground resistance of 0.5Ω . The ground resistance value is below the low alarm threshold of 8Ω , a beep will sound.

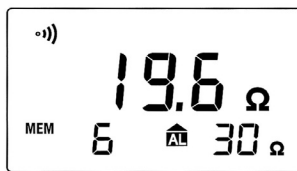

Buzzer ON.

A loop ground resistance of 19.6Ω . The ground resistance value is below the high alarm threshold of 30Ω , no beep will sound. There are 6 recorded values in the memory.

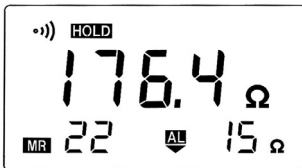

Buzzer ON.

Read the 22nd recorded measurement, the ground resistance is 176.4Ω . The ground resistance low alarm threshold is set at 15Ω .

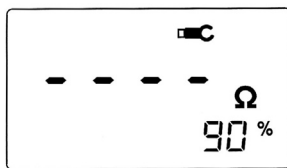

The jaw is not closed properly. The battery life is at 90%.

continued ...

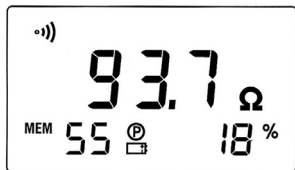

Buzzer ON.

A loop ground resistance of 93.7Ω.

The battery life is at 18%.

At less than 20% the batteries need to be replaced. Auto power off has been enabled. There are 6 recorded values in the memory.

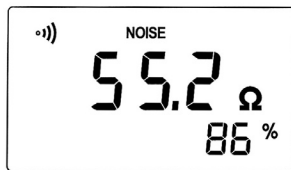

Buzzer ON.

The current in the grounding loop has been disturbed, the reading is 55.2Ω, however the resistance measurement could have been affected. The battery life is at 86%.



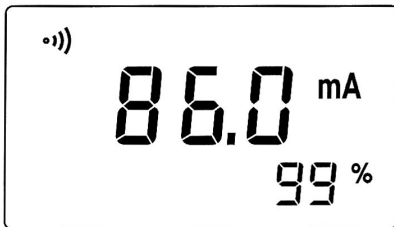

Current Measurement

1. Press the arrow A button.
2. The display will show the current unit of measure, A or mA. You can now measure the current of the conductor.
3. Read the measurement value on the display.
4. If the display shows the OL symbol, this indicates the measured value exceeds the measurement range.



continued ...

Alarm Operation

1. When in the resistance measurement mode, press the AL button, the AL symbol and the value of the alarm threshold will be displayed.
2. You can press the AL button several times to select one of three alarm modes:
 - Low Alarm Mode:* When the measurement is below the alarm threshold, a continuous beep will sound at low frequency. The  symbol will show on the display.
 - High Alarm Mode:* When the measurement is above the alarm threshold, a continuous beep will sound at high frequency. The  symbol will show on the display.
 - No Alarm Mode:* No measurement has been set in the alarm threshold.
3. Set the alarm threshold. The default setting is high alarm threshold of 20Ω. In the resistance measurement mode, press the POWER + AL buttons to set the alarm threshold value. The AL symbol and the value of the alarm threshold will be displayed. Press the  A or  Ω buttons to increase or decrease the alarm threshold value, can range from 1 to 100Ω inclusively. You can now select one of the three alarm modes by pressing the AL button several times. Once done, press the  to exit the alarm value setting mode. This value will not change when the meter is turned off.

Memory

Clearing the memory

Press the HOLD + MEM buttons for 3 seconds, the CLR symbol will then appear on the display. Once the beep sounds, the memory has been cleared. The meter will return to the measurement mode automatically.

Saving measured values

Press the MEM button for 2 seconds, the MEM symbol will then appear on the display. The number of records will automatically increase by one, which is then indicated on the display. When the record is the 99th or when the battery life is at less than 20%, a beep will sound when the MEM button is pressed to indicate that the meter will not record the value.

continued ...

Reading the recorded measurements

Press the POWER + MEM buttons for 1 second, the MR and HOLD symbols will then appear on the display. The number of the reading and the value will be shown one at a time. To display the previous or following record simply press the \blacktriangle A or \blacktriangle Ω buttons. Press the POWER button to exit the read record mode and return to resistance measurement mode.

Special Functions

Turning the buzzer ON & OFF

Press the POWER + Ω buttons, the \bullet) buzzer symbol will disappear from the display and the buzzer is now off. When the buzzer is off, there will be no beep sound when pressing the buttons and the alarm function is disabled. Press the POWER + Ω buttons to turn the buzzer back on.

Turning the auto power off ON & OFF

Press the POWER + HOLD buttons, the P symbol will appear on the display and the auto power off function will be enabled. After 5 minutes of no operation, the meter will turn itself off automatically. Press the POWER + HOLD buttons again and the P symbol will disappear from the display. The auto power off function is now disabled. Press the POWER button for 2 second to turn the meter off manually.

Overload Function

OL will appear on the screen when the measured value exceeds the measurement range (1200 Ω resistance and 20A current).

Hold

Press the HOLD button to record the current measurement in measurement mode.

Battery Replacement

The  symbol indicates that the batteries are weak and they need to be replaced.

1. Turn the meter off
2. Remove the screw on the battery cover
3. Remove the cover and the battery box
4. Remove the battery from the battery box
5. Install new battery, respecting the correct polarity
6. Reinstall the battery box and the cover
7. Reinstall the screw on the battery cover

Note: Use of the instrument for the first time requires the batteries to be charged for 10 hours.

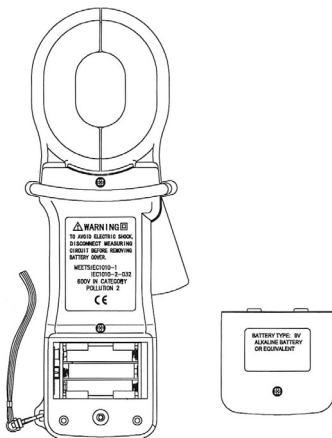

For service on this or any other REED product or for information on other REED products, contact REED Instruments at info@reedinstruments.com

Field Applications

This ground resistance clamp meter is designed to test the ground resistance of any loop system. In addition to measuring the ground resistance of electric power transportation conductors and communication circuitry, this meter also measures the ground resistance of electric equipment and lightning arresters. When the current in the grounding loop has been disturbed, the resistance measurement can be affected. The interference current can be tested by the ground resistance clamp.

Principles of Measurement

R_x: Ground resistance value to be tested

R₁//R₂//...R_n: multiple parallel ground resistance

R_{earth}: normally 0Ω

R_{guard wire}: normally 0Ω

R_{loop}=R_x+R_{earth}+(R₁//R₂//...R_n)+R_{guard wire}

When R₁//R₂//...R_n<<R_x, then R_{loop}=R_x

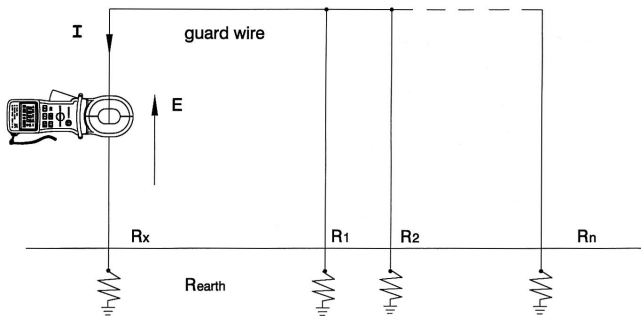

continued ...

Distribution of Electric Power

The distribution of electric power on the ground is transmitted by wire shelf, every wire post has it's own ground protection. Measurement mode as follows:

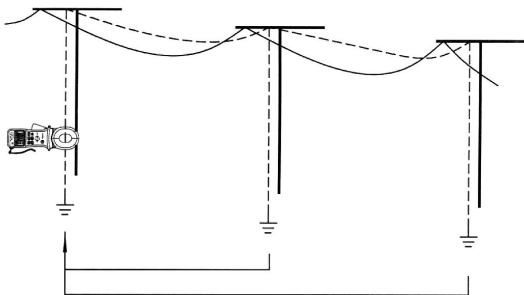

Configuration of Telecommunications System

To protect telephone lines from being interfered, the telecom maintenance department uses conduction wires to insulate the telephone lines. As the following drawing indicates, you can use the ground resistance clamp meter to simply test each ground point.

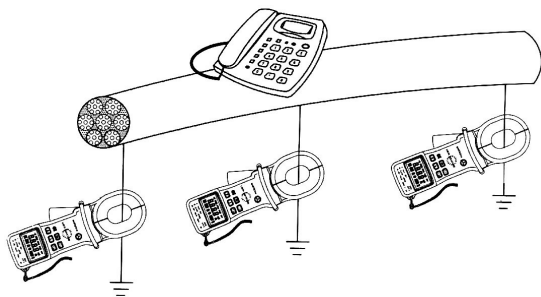

continued ...

Faraday Cage Protection System

The principle of the Faraday Cage is that the conduction wire is connected with the ambient ground of one instrument, a group of equipment or one building. It can't be interfered with externally.

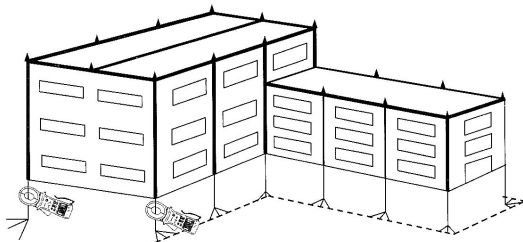

Application of Gas Stations

Testing of ground resistance is necessary for gas stations to prevent static electricity. Apply ground electrodes of oil trough to supplementary electrodes to test ground resistance of the gas station. The test result is the sum for the ground resistance of the gas station and the ground resistance of the oil trough in series.

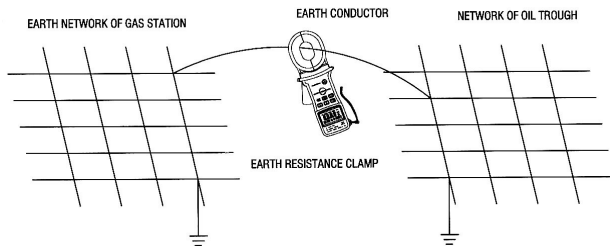

As indicated in the above measurement mode, it can be applied to the measurement of the lightning rod and the oil trough.

