

## LC20 Quick-start Guide

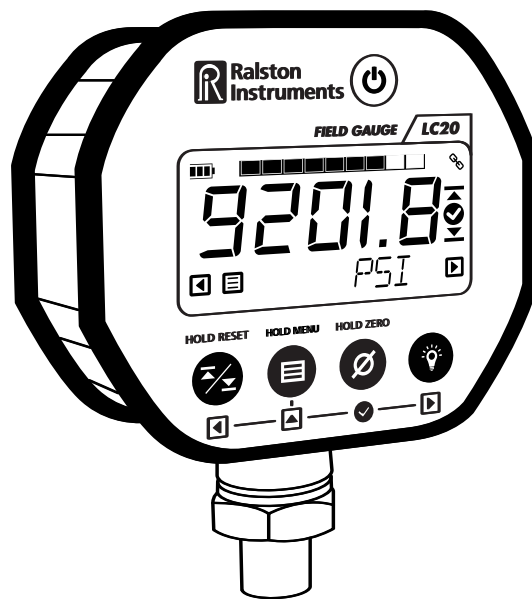

For all models of Ralston LC20 Digital Pressure or Temperature Gauges

## Table of Contents

Included Items .....	3
Important Safety Notices .....	5
LC20 Features Overview.....	12
Activate Your LC20.....	20
Updating LC20 and FieldLab Desktop.....	25
Operation Instructions .....	28
Button Functions.....	44
Menu Functions .....	52
Battery Installation .....	62

**Calibration.....64**

**Specifications .....65**

**Radio Information** (For models with W1 radio option installed)..... **70**

**Standards and Agency Approvals .....74**

**Support.....80**



## Included Items

- EN** Items included in the package. If any items are missing, please contact your Ralston Instruments distributor.
- **LC20 Pressure or Temperature gauge**
  - **2 x AA batteries**
  - **2 meter USB Micro-B cord**
  - **For gauges with W1 option - DGAU-0050 USB Dongle and D-001576 antenna**
-

## Important Safety Notices

**EN** ⚠ **WARNING: Do not operate in hazardous locations.**

⚠ **WARNING:** Do not use LC20 until you have read and fully understand the instructions and hazards of the product.

⚠ **WARNING:** Contents may be under high pressure or temperature.

⚠ **WARNING:** Any modifications to this product with custom parts can result in hazardous operation of the product.

⚠ **WARNING:** Use eye protection while using this device.

⚠ **WARNING:** Do not overpressure LC20 or damage may result.

⚠ **WARNING:** This product can expose you to chemicals including Lead, which is known to the State of California to cause cancer, and is known to the State of California to cause birth defects or other reproductive harm. For more information go to [www.P65Warnings.ca.gov](http://www.P65Warnings.ca.gov).

⚠ **CAUTION:** Installation of LC20 must be in accordance with Ralston Instruments installation instructions.

⚠ **CAUTION:** Installation of LC20 must be in accordance with applicable local, national and international standards and electrical codes.

⚠ **CAUTION:** Batteries are not rechargeable and will not be recharged via USB.

⚠ **CAUTION:** Use only approved AC/DC power adapter model D-000410.

⚠ **CAUTION:** Protection impairment may occur if used in a manner not specified by Ralston Instruments.

⚠ **CAUTION:** Only those personnel trained in the use of this device shall operate it.

# LC20 Features Overview

Front

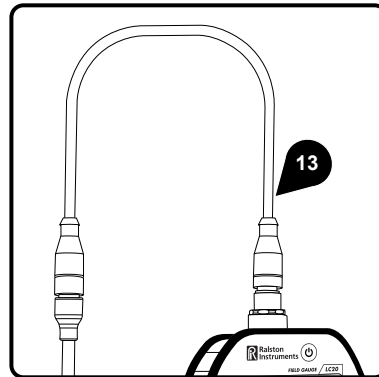
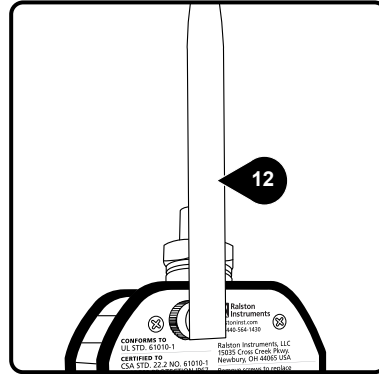
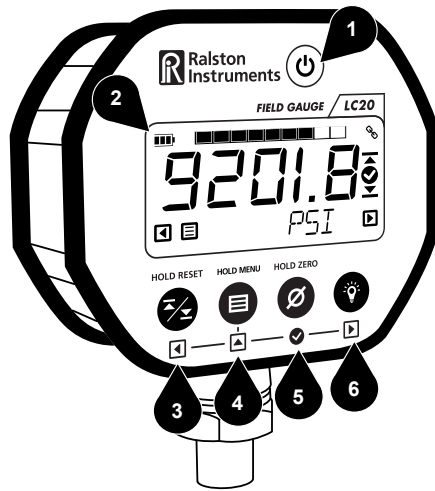

Back

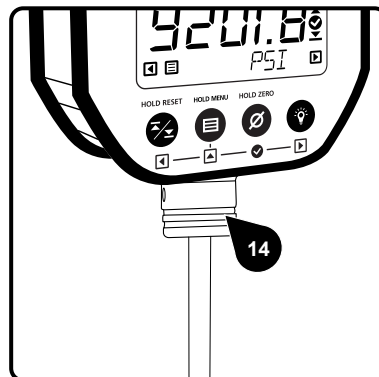
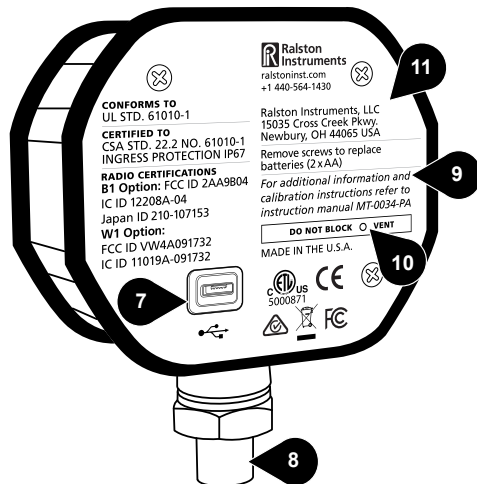

12



## **EN**

1. Power
2. LCD display
3. Left arrow / High/Low/Reset
4. Up Arrow / Menu
5. Accept / Zero
6. Right Arrow / Backlight
7. Micro USB port
8. Pressure sensor option
9. Battery access door
10. Pressure equalizing vent
11. Warning label
12. Antenna option (W1)
13. External temperature probe (TX)
14. Temperature sensor option (TA)

## LCD display



## EN

1. Battery indicator
2. Graphical pressure/temperature meter
3. Connection symbol (USB or wireless)
4. Check mark to indicate success
5. High and low arrows
6. Main pressure/temperature display
7. Secondary display



## EN

- ✔ **Power Management**  
Configure display and power management to maximize battery life in the field using FieldLab Desktop software.
- ✔ **Graphic Pressure or Temperature Meter**  
See pressure or temperature graphically
- ✔ **High / Low Readings**  
See continuous Maximum and Minimum pressure or temperature readings over a span of time
- ✔ **Easily Change Engineering Units**  
Change to any of the 18 standard pressure engineering units or 4 standard temperature units on the fly. Manage frequently used units or remove unused units with FieldLab Desktop.
- ✔ **Custom Engineering Units**  
Create custom engineering units using FieldLab Desktop and add them to any LC20 gauge.
- ✔ **View Live Readings on Your PC**  
View real-time pressure and/or temperature readings on your PC from your LC20 gauge using FieldLab Desktop via USB or wireless.
- ✔ **Log Data on Your PC**  
Log pressure and/or temperature data on your PC from your LC20 gauge using FieldLab Desktop via USB or wireless.

## Activate Your LC20

### EN

Before using your LC20 for the first time, you should activate it and link it to your PC. Note that this is optional and only required if you want to change any settings on the LC20 or calibrate it.

### 1 Download & Install FieldLab Desktop

Visit [\[redacted\]](#) to download and install FieldLab Desktop on your Windows PC\*

### 2 Open & Follow onscreen instructions in FieldLab Desktop software

Follow the onscreen directions closely before connecting your LC20. Do not connect your LC20 until instructed to do so.

### 3 You're ready to begin!

Find detailed support articles for changing settings, viewing live readings and logging data at [\[redacted\]](#)

\* Windows version 7 or greater only. Administrative rights required to install FieldLab Desktop software.

## Updating LC20 and FieldLab Desktop

EN

### Updating FieldLab Desktop

Open FieldLab Desktop on your computer, and select FieldLab > Check for Updates.

### Updating your LC20

1. Open FieldLab Desktop on the computer you use to manage your LC20.
2. Connect the LC20 using the USB cable.
3. Select the LC20 from the FieldLab's menu. Any available updates will be displayed.

## Operation Instructions

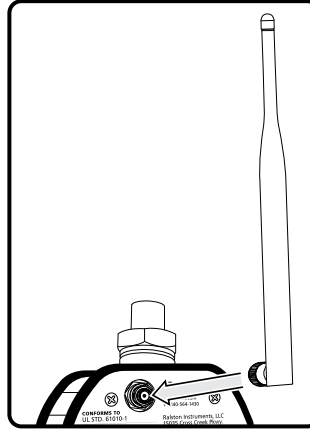
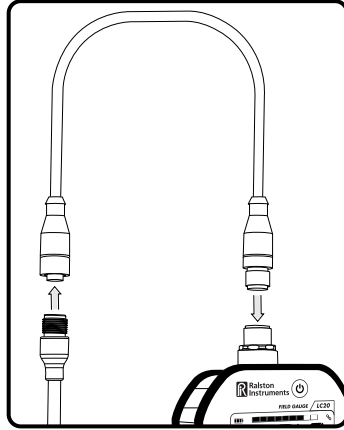

EN

### Conditions of Use

- **Environment:** Indoor use or temporary outdoor use. For long term or permanent outdoor use, a suitable enclosure may be required.
- **IP67 Rating:** LC gauges with external thermal probes must have the thermal probe cable installed in M12 connector on gauge to maintain IP67 rating.
- LC gauge requires (2) AA Batteries, power from a PC via USB or power from AC power adapter D-000410 via USB to operate.
- **RF Exposure Statement:** The LC20 device when used with approved antenna complies with the FCC and IC portable RF Exposure limits set forth for an uncontrolled environment and is safe for intended operation as described in the user manual. To comply with RF exposure limits established in the ANSI C95.1 standard, the distance between the antenna and the user should not be less than 25 cm (10 inches) for USA and 34 cm for Canada. Further RF exposure reduction can be achieved if the product can be kept as far as possible from the user's body.

### Installation Instructions

- Ensure that gauge is oriented in such a way that the "Power" button is

28

always easily accessible.

- If pressure sensor option is installed, then seal pressure connection with thread sealant prior to assembling it in any pressure system.
- If temperature sensor option is installed, then connect thermal probe using a rated thermal well or other approved device.
- Place gauge in area that is protected from damage from weather, excessive temperature, impact or humidity.

## **Connecting to Accessories or Other Equipment**

### **Connect to a PC via USB cable**

- Use only approved USB cable P/N D-000040

### **Connect to AC Mains**

- Use only approved power adapter P/N D-000410 and approved USB cable P/N D-000040

### **Connect to External Thermal Probe**

- Connect thermal probe cable to gauge using male end of thermal probe cable.
- Connect thermal probe to cable using female end of thermal probe cable.
- If cable is being installed permanently, then secure cable following all applicable electrical standards.
- Use only approved thermal probe P/N D-000403 that has been calibrated with this device.
- Use only approved thermal probe cable P/N D-0000404.
- External thermal probe is calibrated with the base unit. If thermal probe is changed, then use FieldLab Desktop to update the serial number and calibration coefficients of the new thermal probe.

### **Connection of Antenna (W1 option)**

- Thread approved antenna into gauge RF connection
- Align antenna vertically for best signal reception
- Do not obstruct line of sight between antenna and receiver with metal or dense materials or a reduction or loss of signal may result
- Use only approved antenna P/N D-001576 with “W1” option

### **Wireless Radio (W1)**

- Connect to PC using included dongle P/N DGAU-0050
- Select the same channel on the gauge and the Desktop software

## **Instructions for Cleaning or Decontamination**

- Clean enclosure with mild water-based cleaner. Do not use aggressive solvent.
- Flush pressure sensor or thermal probe with alcohol based cleaner (or other cleaner compatible with 316 Stainless steel) if toxic or other hazardous substance is used.

## Button Functions

EN



### Power

- Press and hold to turn on.
- When LC20 is on, press and hold to turn off.

**Note:** LC20 will turn off automatically based on setting in FieldLab Desktop. Default time is 10 minutes, but can be changed using FieldLab Desktop software.



### Hi/Low/ Reset

- Press button once to display highest pressure or temperature reached.
- Press button again to display lowest pressure or temperature reached.
- Press and hold button again to clear high and low values.
- Hi/Low/Reset applies to the Active Sensor. If there are 2 sensors, then change sensors to use Hi/Low/Reset for the other sensor.



### Menu

- If 2 sensors, quick press to change sensors.
- Long press initiates MENU and follow prompts.



### Zero Pressure

- With no pressure applied, press and hold button to zero reading.

**Note:** If pressure is greater than 10% of gauge pressure range, then a message to vent the pressure will appear.



### Backlight

- Press button to illuminate backlight.

**Note:** Light will turn off after a set time. Both time and brightness can be adjusted in FieldLab Desktop software.

# Menu Functions

## Menu

1

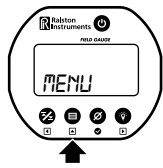

Push and hold the Up Arrow/Menu button until "MENU" appears.

2



Push the Right and Left Arrow buttons to scroll through the menu items.



## Change Units

1

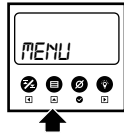

Push and hold the Up Arrow/Menu button until "MENU" appears.

2

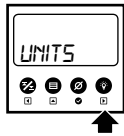

Scroll to UNITS

3



Push the Accept / Zero button to enter the UNITS submenu.

4

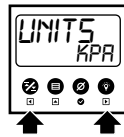

Scroll through the engineering units.

**5**



Accept to change to the displayed engineering unit.

### Turn on Wireless Radio (W1 option)

**1**

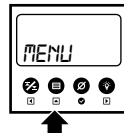

Push and hold the Up Arrow/Menu button until "MENU" appears.

**2**



Scroll to RADIO

**3**

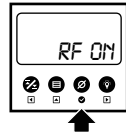

Push the Accept / Zero button to enter the Radio submenu.

**4**

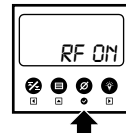

Push the Accept / Zero button to turn on the wireless radio.

**5**



Gauge is now ready to connect with other devices wirelessly.

**6**



Gauge is connected when link icon is solid.

## Change Wireless Radio Channel (W1 option)

1

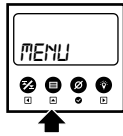

Push and hold the Up Arrow/Menu button until "MENU" appears.

2



Scroll to RADIO

3

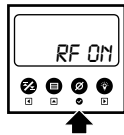

Push the Accept / Zero button to enter the Radio submenu.

4



Scroll to CHANNEL.

5

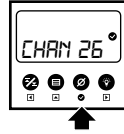

Accept to enter the Channel submenu.

6



Checkmark indicates current channel.

7

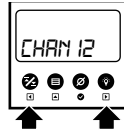

Scroll to the channel you want to use.

8



Accept to set new channel.

## Adjust settings for Radio Auto-on/Auto-off (W1 option)

Auto-on = Radio always on when gauge is powered on.

Auto-off = Radio is off by default. Ideal for minimizing battery drain.

1

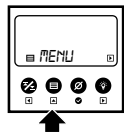

Push and hold the Up Arrow/Menu button until  
"MENU" appears.

**2**



Scroll to RADIO

**3**

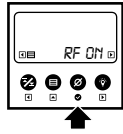

Push the Accept / Zero button to enter the Radio submenu.

**4**

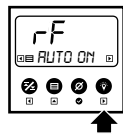

Scroll to RF AUTO ON.

**5**

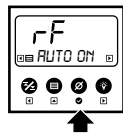

Push the Accept/Zero button to set the radio to AUTO ON/OFF

## View Firmware Version

1

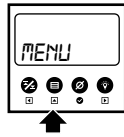

Push and hold the Up Arrow/Menu button until "MENU" appears.

2



Scroll to FIRMWARE.

3



Accept to view firmware version.



## View Last and Next Calibration Dates

1

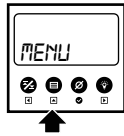

Push and hold the Up Arrow/Menu button until "MENU" appears.

2



Scroll to LAST CAL or NEXT CAL

3



Accept to view calibration date.

## Battery Installation

1

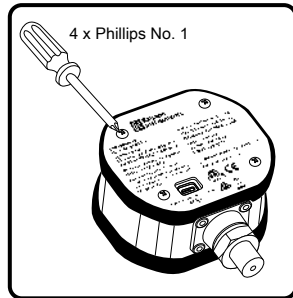

2

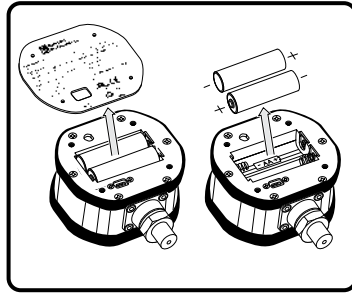

3

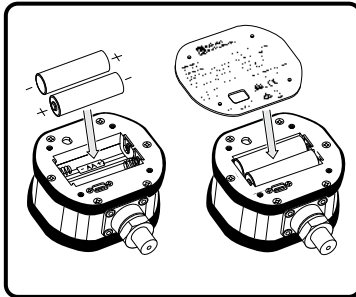

4

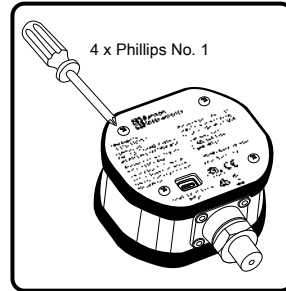

### EN

#### Recommended Alkaline AA Batteries (2X) (ANSI 15A, IEC LR6)

- Duracell MN1500
- Energizer EN91
- Energizer E91
- Rayovac Max Plus 815

## Calibration

### EN

- Download PC software at
- Follow instructions in software on how to calibrate pressure or temperature

## Specifications

**Antenna** D-001576 antenna (included with W1 models) /

---

**Batteries** 2 x AA (LR6)

---

**Battery Life** 1,500 hours typical

---

**Digital Interface** USB Micro-B (on back)

---

**Dimensions (not including temp. probe)** 3.5 x 4.1 x 2.2 in (8.9 x 10.4 x 5.6 cm)

---

**Display** 5 x 0.5 in (12.7 mm) upper digits

8 x 0.2 in (5 mm) lower digits

---

**Electrical Rating** USB Mode - 5 VDC, 0.25W  
Battery Mode - 3 VDC, 0.25W  
Power Adapter - 90 ~ 264 VAC Input, 5 VDC @  
1 Amp Output

**Environment** Indoor use  
Temporary outdoor use

---

**Ingress Protection** IP67 (1 meter submersion for 30 minutes)

---

**Materials of Construction** Polycarbonate, Aluminum, 316L Stainless Steel

---

**Media Compatibility** Gases and liquids compatible with 316L S.S.

---

**Operating Altitude (max)** 10,000 ft (3050 m)

---

**Operating Temperature Range (Enclosure)** -4 to 122°F (-10 to 50°C)

---

**Power** 2 x AA batteries, D-000040 power adapter (optional)

**Protection Class** Pollution Degree 2

---

**Relative Humidity** 90% RH 14 to 95°F (-10 to 35°C)  
75% RH 95 to 104°F (35 to 40°C)  
45% RH 104 to 122°F (40 to 50°C)

---

**Storage Temperature Range** -40 to 167°F (-40 to 75°C)

---

**USB Cable** USB Micro, 2 meter, shielded

---

**Weight** 12 oz (340 g)

---

**Wireless Link** DGAU-0050 USB dongle (included with W1 models)

**Pressure Specifications**  
(for all models with pressure connection, if included)

**Pressure Accuracy** +/-0.1% of full scale  
(ASME Grade 4A / ISO Class 0,1)

**Pressure Connection** 1/4" Male NPT

**Temperature Specifications**  
(for all models with thermal probe, if included)

**External Temperature Probe** M12 female, A Code, Silicone seal, IP67

---

**External Thermal Probe Temperature Range** -22 to 302°F (-30 to 150°C)

---

**Internal Temperature Probe** Permanently mounted - dimensions vary with model, IP67

---

**Temperature Accuracy** +/- (0.27 + 0.004\*|t|) °F  
+/- (0.15 + 0.002\*|t|) °C  
(IEC 60751 Class A)

## **W1 - Wireless Radio Specifications (if included)**

### **EN**

- Contains FCC ID VW4A091732
- Contains IC Module ID 11019A-091732



## **Radio Information** (For models with W1 radio option installed)

**EN**

### **FCC Declaration of Conformity**

This device complies with Part 15 of the FCC Rules. Operation is subject to the following two conditions:

- (1) this device may not cause harmful interference, and
- (2) this device must accept any interference received, including interference that may cause undesired operation.

### **Industry Canada Declaration of Conformity**

This device complies with Industry Canada's licence-exempt RSS standards. Operation is subject to the following two conditions:

- (1) this device may not cause harmful interference, and
- (2) this device must accept any interference received, including interference that may cause undesired operation of the device.

## Standards and Agency Approvals

### EN

This product complies with the following standards. Refer to EC Declaration of Conformity for specific details

- CAN/CSA-C22.2 No 61010-1-12: 3rd Edition
- UL 61010-1: 3rd Edition
- EN/IEC 61010-1:2010
- AS 61010-1, 3rd Edition
- IEC 61326-1:2012 2nd Edition
- Pressure Equipment Directive (PED) 2014/68/EU
- Electromagnetic Compatibility Directive (EMC) 2014/30/EU

### Electromagnetic Specifications

<b>Conducted RF</b>	IEC 61000-4-6, performance criterion B
<b>DC Power Burst</b>	IEC 61000-4-4, performance criterion B
<b>DC Power Surge</b>	IEC 61000-4-5, performance criterion B
<b>Electro-static Discharge Immunity</b>	IEC 61000-4-2:2008, performance criterion B
<b>Radiated Emissions</b>	CISPR 11:2009, Group 1, Class B
<b>Radiated, Radio-Frequency Electromagnetic Immunity</b>	IEC 61000-4-3:2006, performance criterion A
<b>RF Field effects on Measurement Accuracy</b>	Accuracy of Pressure and Temperature is not specified for RF fields > 3V/m