

# Fieldpiece®

## Refrigerant Leak Detector

### OPERATOR'S MANUAL

Model DRX3



## Description

The compact and rugged DRX3 Refrigerant Leak Detector helps you find leaks fast in the field. It comes equipped with a sensitive heated diode sensor that quickly detects HC, HFC, HCFC, CFC, HFO, H<sub>2</sub>/N<sub>2</sub> (Tracer Gas), and blend refrigerants, as well as heating fuels (natural gas, propane, butane, and methane).

Multiple indicators ensure you catch even the smallest leaks. The flashing LED at the tip lets you keep your eyes on the target. The loud beep changes with leak intensity. The large backlit LCD displays bars and numerical values of relative leak intensity, and it is visible in both bright sunlight and low light. And with the Job Link® System app you can see the readings right on your phone.

You have full control to hone in on leaks with the ability to switch between automatic (AZERO) and manual (MZERO) zeroing modes.

Detect more leaks with up to 60 hours on a set of four AA Lithium Iron Disulfide batteries. Replaceable batteries means no time wasted waiting for it to charge. The DRX3 is ready whenever you are. It's built for the field with a rugged IP54 main body designed to keep out water and dust.

## What's Included

- DRX3 Refrigerant Leak Detector
- Heated Diode Sensor for A3/A2L/A1 (RXA3)
- 4x AA Lithium Iron Disulfide Batteries
- Blow Molded Carrying Case
- Operator's Manual
- 1 Year Limited Warranty

## Safety First!

**RISK OF EXPLOSION. DANGER:** This machine is for use only by qualified and certified technicians in the safe use, handling, and transporting of refrigerants or combustible gases. Please refer to flammable refrigerant and gas safety guides, regional codes and legislation for more information. Read and understand this operator's manual in its entirety before using to prevent injury or damage to you or equipment.

**⚠ WARNINGS – failure to heed these hazards and actions while using this device can result in serious injury or death. This device is intended to be used strictly as a leak detector (spot reading device). THIS IS NOT A SAFETY DEVICE INTENDED FOR MONITORING REFRIGERANT OR HEATING GAS LEVELS.**

- WARNING: EXPLOSION HAZARD. Verify the batteries are installed correctly and that the cover is properly sealed outside of the Temporary Hazard Zone with a 3-meter/10 foot perimeter.
- WARNING: EXPLOSION HAZARD. Do not change batteries in the Temporary Hazard Zone.

- WARNING: EXPLOSION HAZARD. Do not remove or change the sensor tip or module in the Temporary Hazard Zone.
- Always wear Proper Protective Equipment (PPE), which includes gloves and safety glasses.
- Know proper safety and handling requirements of the refrigerant or gas in the Safety Data Sheet (SDS).
- Avoid breathing refrigerant, gas, and oil vapors. Inhalation of high concentrations of refrigerant vapor can block oxygen to the brain causing injury or death.
- Perform leak detection in accordance with recommended practice.
- Only work in well-ventilated areas (minimum of 6 air exchanges per hour).
- Electrostatic hazard - don't clean with dry cloth, ensure that user is appropriately discharged/grounded
- Inspect this device prior to use. Do not use if there is obvious damage.

**⚠ WARNING: EXPLOSION HAZARD. Below are additional safety instructions for handling A2L and A3 refrigerants with other equipment.**

- Adhere to local occupational safety codes and possess detailed knowledge and skills when handling flammable refrigerants.
- Have emergency, evacuation, and fire protection plans.
- Designate and monitor a Temporary Hazard Zone with a 3-meter/10 foot perimeter. Identify and disable all possible ignition sources within this zone. Monitor air to verify refrigerant levels stay below hazardous levels as specified in Safety Data Sheet (SDS). Use a ventilation fan to maintain 6 air exchanges per hour within this zone.
- WARNING: EXPLOSION HAZARD. When using additional corded equipment, ensure unit(s) power is switched OFF (O) before connecting and lock the power cord onto the unit(s). Continue by connecting the main power. Connect any other equipment outside of the Temporary Hazard Zone.

- WARNING: EXPLOSION HAZARD. For battery powered devices, recharge or replace batteries outside of the Temporary Hazard Zone.
- WARNING: EXPLOSION HAZARD. When using additional equipment, ensure area around the device(s) is free of debris that could enter air vents and fan and cause accidental sparking.
- WARNING: EXPLOSION HAZARD. Always remain in attendance and observant when equipment is operating.
- Do not mix flammable refrigerants with air.
- If recovering a system with a suspected leak, stop recovery at 0 psig/bar to prevent air from entering the recovery tank.
- Use an evacuated recovery tank that complies with local regulations.
- After recovery, purge system with 100% nitrogen before opening system for repair.
- Handle hoses and equipment carefully as refrigerant is under high pressure and can cause frost bite.
- Ensure power and extension cords are in good working condition to prevent shock and spark hazards.
- Failure to use as intended / per instructions will void warranty and functionality of equipment.

**⚠ CAUTIONS – Failure to heed these conditions can cause equipment damage.**

- Ensure that all equipment is in good working condition.
- Prevent prolonged exposure to direct sunlight. Store indoors.
- Do not submerge the sensor tip in water. Sensor will need to dry out before resuming function.
- The unit must be protected against severe impact. Solid objects must not be allowed to fall onto the unit.

## Quick Start

- Install sensor (see next panel for details).
- Move to a refrigerant-free and combustible gas-free environment and hold until your DRX3 powers on.
- Allow warm up process to complete.
- Press **REFRIGERANT** button as needed to select the appropriate setting for refrigerant or gas type.
- Begin searching for the leak source.  
*Move the tip slowly ~ 7.6 cm (3 inches)/sec and as closely as possible to the suspected leak source.*
- Search until leak is detected.  
*Red light flashes, audible alarm triggers, and the display indicates the relative gas intensity.*
- Confirm leak source.  
*Move tip away from alarm location for a few seconds to clear the sensor. Return tip back to suspected leak, looking for the highest value.*

Scan the QR code to visit your Fieldpiece website and register your product.



US, CA, MX



EN, DE, FR, IT, ES, PT, NL, NO, SE, DK, FI

## Sensor Installation

- Ensure your DRX3 is powered off.
- Align the new sensor tip (RXA3) notch with the module notch, and push into place at the end of the module. **DO NOT TWIST OR BEND PINS.** The RXA3 sensor tip works for all specified refrigerants, tracer gas, and heating gases.
- For a new sensor, enter factory mode by holding , **ZERO** and **SENSITIVITY** buttons together > 5 seconds.
- Press **ZERO** until "2. Reset Sensor Life" appears. Press and hold **ZERO** and **SENSITIVITY** to reset sensor hours.
- Press and hold to power off.

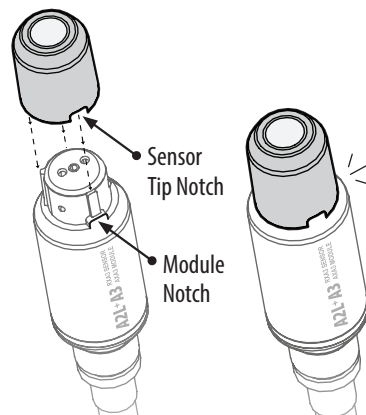

1.888.610.7664

## Maintenance

**CLEANING:** Wipe with damp cloth to clean the exterior. Do not use detergents or solvents.

**BATTERY REPLACEMENT:** Place the unit face down on a non-abrasive surface. Remove the 4 screws, lift the panel off and remove the old batteries. Replace with 4x Replaceable AA Lithium Iron Disulfide batteries. **NOTE:** Ensure the red seal is fully inside the groove when replacing the panel and tightening the 4 screws.

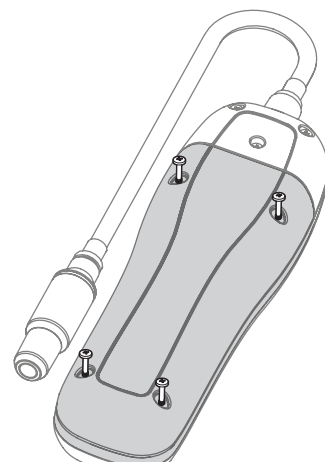

[www.calcercert.com](http://www.calcercert.com)

**SENSOR REPLACEMENT:** Ensure your DRX3 is powered off. Remove the old sensor by holding the module firmly and pulling the sensor tip straight out. **DO NOT TWIST.**

Align the new sensor tip (RXA3) and push into place at the end of the module. **DO NOT TWIST OR BEND PINS.** For a new sensor, with the unit powered off, enter factory mode by holding , **ZERO** and **SENSITIVITY** buttons together > 5 seconds. Press **ZERO** until "2. Reset Sensor Life" appears. Press and hold **ZERO** and **SENSITIVITY** to reset sensor hours. Press and hold to power off. **NOTE:** Do not reset sensor hours if you are re-installing the same sensor.

Depending on gas exposure, the RXA3 sensor should be replaced after approximately 300 hours of use.

**FIRMWARE UPDATE:** On the Job Link® app, if there is a firmware update available, you will be notified by a notice on the bottom of the screen and a red dot by the tool. Tap the red dot, and follow the steps to download/install the latest firmware.

With the DRX3 powered off, press and hold **SENSITIVITY**, and then > 5 seconds to access Update Mode "UPDATE".

[sales@calcercert.com](mailto:sales@calcercert.com)

## Functionality Test

Use a refrigerant tank and a cap to check if your DRX3 is detecting refrigerant properly.

- Tightly cap a refrigerant tank port to seal it.

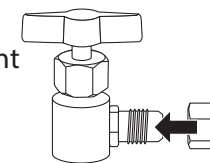

- Open valve to coat the inside of the cap, then close the valve.

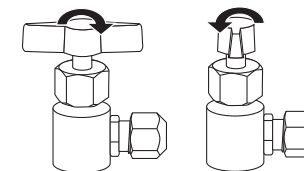

- With DRX3 set to high sensitivity (**H**), remove the cap and wave the tip over the cap. You should see a very large leak size of approx. "99" and a full bar graph. If not, the sensor may need to be replaced.

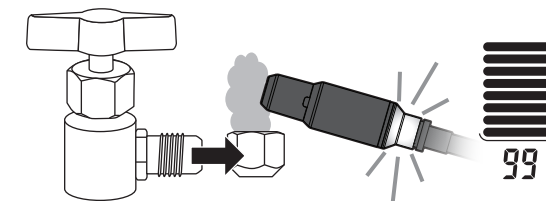

# Operation

## Power

Press and hold >1 second to toggle power.

## Backlight

Press to toggle the blue backlight.

## Refrigerant and Heating Gas Selection

After warm up, press and hold **REFRIGERANT** to select A1-2L, specific A3 refrigerants (R-290, R-600a, R-600, R-50, R-1270), or H2/N2.

For heating fuels use these settings:

- Natural Gas, Methane: NTR-G
- Propane: PROP
- Butane: BUTN

## Zero Modes

DRX3 starts up in automatic zero mode (AZERO) which sets a new zero point every three seconds, indicated by AZERO blinking twice.

Moving closer to the leak source will show the relative increase in concentration, triggering the alarm. Conversely, stopping at or moving away from the leak source will not trigger a response.

Press and hold **ZERO** and **SENSITIVITY** > 2 seconds to toggle manual zero mode (MZERO). DRX3 does not zero automatically while MZERO is displayed and will continue to alarm and display the relative leak size.

## Zero Set

Press **ZERO** to manually set the currently measured concentration to 0, indicated by **Message Line** blinking twice.

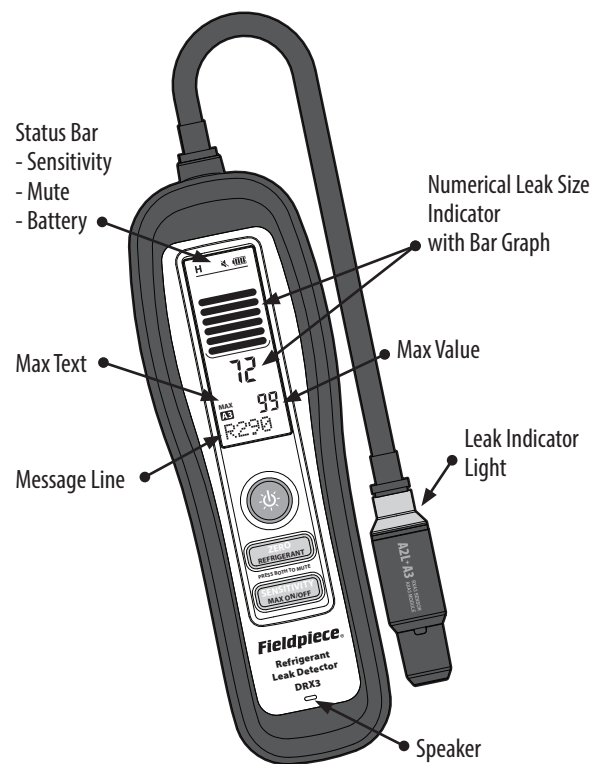

## Numerical Leak Size Indicator with Bar Graph

The number is the relative concentration of refrigerant gas (0-99 units). The bar graph shows the same measurement in steps for easy monitoring. The higher the number, the higher the concentration of gas being measured and the closer you are to the exact leak location.

## Maximum Mode

Press and hold **MAX ON/OFF** >1 second to toggle max mode. When max mode is on, the highest leak size detected is continually recorded.

The recorded max is cleared when the sensitivity is changed, selected refrigerant is changed, or if manually zeroed.

## Sensitivity (H/M/L)

DRX3 starts up in High (**H**) sensitivity which is recommended for most situations. When leaks are difficult to pinpoint due to excess triggering or sensor saturation, press **SENSITIVITY** to cycle to a lower sensitivity (Medium/Low).

## Mute (M)

Press **ZERO** and **SENSITIVITY** < 1 second to toggle the speaker on/off.

## Leak Indicator LED

In most situations, the red LED at the tip is easier to monitor than the display. Because the blink rate increases as the relative concentration increases, many leaks can be found without ever viewing the display.

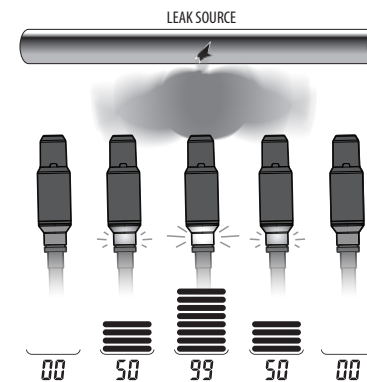

## Sensor Hours Counter

With the unit powered off, to check current sensor hours, press and then hold , **ZERO** and **SENSITIVITY** to enter factory mode. Press **ZERO** until "2. Reset Sensor Life" is displayed. If counter is over 300 hours, replacement of the sensor is recommended. Power off unit to exit factory mode without resetting the counter.

## CONNECTING TO JOB LINK®

Power on the DRX3 and allow it to warm up. On the Job Link® app, select **Measurements** from the home screen, then . For the **Leak Detection** section, tap **LINKTOOL** and select the DRX3. You'll now be able to view the relative concentration of the refrigerant gas (0-99 units) with the Numerical Leak Size Indicator and Bar Graph.

Select **LOG** to record your measurement.

**TAG** to record a note such as location.

**EDIT** to edit the TAG.

Tap **Options** on the bottom right corner to **Create PDF** for a detailed report to share with your customer.

# Specifications

- Sensor Type:** Heated diode
- Sensor Life:** 300 hours typical
- Sensitivity Levels:** High, Medium, Low (selectable)
- Maximum Sensitivity:** 1g/yr (0.03 oz/yr), stationary; 3g/yr (0.1 oz/yr), in motion
- Detection Feedback:** Flashing LED, LCD bar graph and digits, audible beep, Job Link® app
- Refrigerants:** HC, HFC, HCFC, CFC, HFO, H<sub>2</sub>/N<sub>2</sub> (Tracer Gas: 5% Hydrogen, 95% Nitrogen), and blends
- For Use With:** A3 (R-290, R-600a, R-600, R-50, R-1270), A2L (Including R32, R1234yf, R1234ze), and A1 refrigerants
- Heating Gases:** Natural Gas, Propane, Butane, Methane
- Not For Use With:** R-702, R-717, R-744 refrigerants
- Safety Compliance:**
  - ATEX Zone 2 (II 3 G Ex ic IIA T2 Gc)
  - Class I, Division 2, Group D, T2 Hazardous Locations
- Operating Environment:** -20°C to 50°C (-4°F to 122°F); < 95% RH (non-condensing)
- Battery Type:** 4x Replaceable AA Lithium Iron Disulfide (To maintain ATEX and CID2 compliance, use 4 x Energizer L91 AA batteries.)
- Battery Capacity:** 1.5 VDC (nominal) 3500 mAh
- Battery Life:** 60 hours typical
- Auto Power Off:** 10 minutes without detection or button press
- Radio Frequency:** 2.4 GHz
- Wireless Range:** Up to 200 meters (656 feet) line of sight
- Storage Temperature:** -20°C to 60°C (-4°F to 140°F); < 95% RH
- Weight:** 442g (15.6 oz) with Batteries Installed
- Water Resistance:** IP54 Main Body
- US Patents:** www.fieldpiece.com/patents

**Wireless Compatibility**  
**Job Link® System Minimum Device Requirement:**  
BLE 4.0 devices running iOS 13.4 or Android Marshmallow 6.0

# Certifications and Compliance

CE QPS 25ATEX0003 X

UK CA UK Conformity Assessed

RoHS Restriction of Hazardous Substances Compliant

Ex II 3 G Ex ic IIA T2 Gc -20°C ≤ T<sub>amb</sub> ≤ 50°C

Class I, Division 2, Group D, T2 -4°F (-20°C) ≤ T<sub>amb</sub> ≤ 122°F (50°C)

Waste Electrical and Electronic Equipment (Do not dispose through typical waste streams.)

Regulatory Compliance Mark

IC: Industry Canada

Note: The design of this device is compliant with all applicable explosion safety related requirements of UL 121201 and CSA C22.2 No. 213 to meet a rating of Class I, Division 2, Group D, T2.

1.888.610.7664

# FCC Statement

This equipment has been tested and found to comply with the limits for a Class B digital device, pursuant to Part 15 of the FCC Rules. These limits are designed to provide reasonable protection against harmful interference in a residential installation.

This equipment generates, uses and can radiate radio frequency energy and, if not installed and used in accordance with the instructions, may cause harmful interference to radio communications. However, there is no guarantee that interference will not occur in a particular installation. If this equipment does cause harmful interference to radio or television reception, which can be determined by turning the equipment off and on, the user is encouraged to try to correct the interference by one of the following measures:

- Reorient or relocate the receiving antenna.
- Increase the separation between the equipment and receiver.
- Connect the equipment into an outlet on a circuit different from that to which the receiver is connected.
- Consult the dealer or an experienced radio/TV technician for help.

**FCC Caution:** To assure continued compliance, any changes or modifications not expressly approved by the party responsible for compliance could void the user's authority to operate this equipment. (Example - use only shielded interface cables when connecting to computer or peripheral devices).

**FCC Radiation Exposure Statement:** This equipment complies with FCC RF radiation exposure limits set forth for an uncontrolled environment. This equipment should be installed and operated with a minimum distance of 0.5 centimeters between the radiator and your body.

This transmitter must not be co-located or operating in conjunction with any other antenna or transmitter.

The antennas used for this transmitter must be installed to provide a separation distance of at least 0.5 cm from all persons and must not be co-located or operating in conjunction with any other antenna or transmitter.

This device complies with Part 15 of the FCC Rules. Operation is subject to the following two conditions:

- (1) This device may not cause harmful interference, and (2) This device must accept any interference received, including interference that may cause

www.calcert.com

# Industry Canada Statement

This device contains licence-exempt transmitter(s)/receiver(s) that comply with Innovation, Science and Economic Development Canada's licence-exempt RSS(s). Operation is subject to the following two conditions:

- (1) This device may not cause interference.
- (2) This device must accept any interference, including interference that may cause undesired operation of the device.

L'émetteur/récepteur exempt de licence contenu dans le présent appareil est conforme aux CNR d'Innovation, Sciences et Développement économique Canada applicables aux appareils radio exempts de licence. L'exploitation est autorisée aux deux conditions suivantes :

- 1) L'appareil ne doit pas produire de brouillage;
- 2) L'appareil doit accepter tout brouillage radioélectrique subi, même si le brouillage est susceptible d'en compromettre le fonctionnement.

**IC Radiation Exposure Statement:** This equipment complies with RSS-102 radiation exposure limit set forth for an uncontrolled environment. This equipment should be installed and operated with minimum distance 0.5 cm between the radiator and your body.

Cet équipement est conforme aux CNR-102 d'Industrie Canada. Cet équipement doit être installé et utilisé avec une distance minimale de 0.5 centimètres entre le radiateur et votre corps. Cet émetteur ne doit pas être co-localisé ou opérant en conjonction avec autre antenne ou émetteur. Les antennes utilisées pour cet émetteur doivent être installées à une distance de séparation d'au moins 0.5 centimètre de toute personne et doit pas être co-située ni fonctionner en conjonction avec une autre antenne ou émetteur.

# Limited Warranty

This product is warranted against defects in material or workmanship for one year from date of purchase from an authorized Fieldpiece dealer. Fieldpiece will replace or repair the defective unit, at its discretion, subject to verification of the defect.

This warranty does not apply to defects resulting from abuse, neglect, accident, unauthorized repair, alteration, or unreasonable use of the machine.

Any implied warranties arising from the sale of a Fieldpiece product, including but not limited to implied warranties of merchantability and fitness for a particular purpose, are limited to the above. Fieldpiece shall not be liable for loss of use of the machine or other incidental or consequential damages, expenses, or economic loss, or for any claim of such damage, expenses, or economic loss.

Local and national laws may vary. The above limitations or [ece-europe.com/store-locator](http://ece-europe.com/store-locator) for local distributors in Europe.

Document: Opman DRX3

© Fieldpiece Instruments, Inc 2025; v27

sales@calcert.com