

8mm Magnetic Connector, 4mm Right-Angle Sheathed Banana Jack

CT3882-#



Features:

- Voltage Max - 1000 V CAT III / 600 V CAT IV
- Current Max - 4 A
- Max Temperature - 80 °C (176 °F)
- Insulation Material - Polypropylene (PP)
- Magnet - N35 / 1.2 Tesla
- RoHS 2 Compliant

Measurement Drawing: (not to scale)

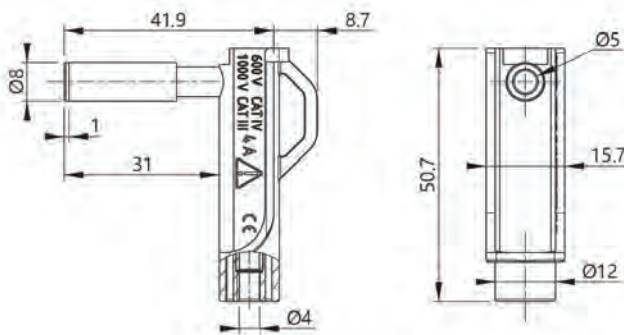

Description:

The 3800 series of Magnetic Connectors facilitates a quick and reliable way to connect to terminal block screws or any other ferromagnetic conductors. These connectors provide ample magnetic hold for hands-free operation.

Specifications and appearance subject to change without notice
D388100 080119



Order Information:

CT3882-#

8mm Magnetic Connector, 4mm Right-Angle Sheathed Banana Jack

- Color - replace '#' with dash number:
-0 Black, -2 Red, -6 Blue, -9 White



Copyright © 2019, Cal Test Electronics, Inc. All rights reserved. Information in this publication supersedes that in all previously published material. Trade names referenced are the service marks, trademarks or registered trademarks of their respective companies.

Specifications and appearance subject to change without notice
D388200 080119

