

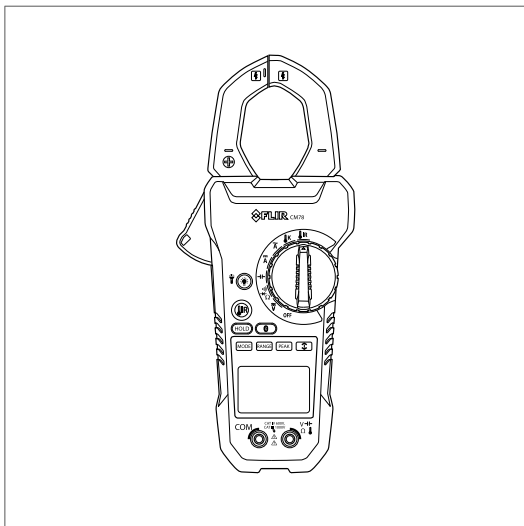

User's manual

FLIR CM78

True RMS Clamp/DMM with infrared
thermometer and Bluetooth METERLINK®





User's manual
FLIR CM78



Table of contents

1	Disclaimers	1
	1.1 Copyright.....	1
	1.2 Quality assurance	1
	1.3 Documentation updates.....	1
	1.4 Disposal of electronic waste.....	1
2	Safety information	2
	2.1 FCC Compliance	5
	2.2 Industry Canada compliance.....	6
3	Introduction	8
	3.1 Key features.....	8
4	Description	9
	4.1 Meter parts.....	9
	4.2 Function switch	10
	4.3 Function buttons.....	11
	4.4 Display icons and indicators	12
5	Operation	14
	5.1 Powering the meter	14
	5.2 Auto/Manual range	14
	5.3 Current measurements	15
	5.4 Voltage measurements	16
	5.5 Resistance measurements	17
	5.6 Capacitance measurements	17
	5.7 Frequency measurements	18
	5.8 Type K temperature measurements.....	18
	5.9 Continuity	18
	5.10 Diode test	19
	5.11 IR temperature measurements.....	19
	5.12 MAX/MIN mode.....	21
	5.13 Peak hold	21
	5.14 Temperature units	22
	5.15 Streaming measurement data using Bluetooth.....	22
6	Maintenance	24
	6.1 Cleaning and storage.....	24
	6.2 Battery replacement	24

Table of contents

7	Technical specifications	25
	7.1 General specifications	25
	7.2 Electrical range specifications	26
	7.3 Thermal range specifications	29
	7.4 Maximum input specifications	29
8	Technical support	30
9	Warranties	31
	9.1 FLIR Global Limited Lifetime Warranty	31
	9.2 FLIR Test and Measurement Limited 2 Year Warranty	32

1 Disclaimers

1.1 Copyright

© 2013, FLIR Systems, Inc. All rights reserved worldwide. No parts of the software including source code may be reproduced, transmitted, transcribed or translated into any language or computer language in any form or by any means, electronic, magnetic, optical, manual or otherwise, without the prior written permission of FLIR Systems.

The documentation must not, in whole or part, be copied, photocopied, reproduced, translated or transmitted to any electronic medium or machine readable form without prior consent, in writing, from FLIR Systems.

Names and marks appearing on the products herein are either registered trademarks or trademarks of FLIR Systems and/or its subsidiaries. All other trademarks, trade names or company names referenced herein are used for identification only and are the property of their respective owners.

1.2 Quality assurance

The Quality Management System under which these products are developed and manufactured has been certified in accordance with the ISO 9001 standard.

FLIR Systems is committed to a policy of continuous development; therefore we reserve the right to make changes and improvements on any of the products without prior notice.

1.3 Documentation updates

Our manuals are updated several times per year, and we also issue product-critical notifications of changes on a regular basis.

To access the latest manuals and notifications, go to the Download tab at:

<http://support.flir.com>

It only takes a few minutes to register online. In the download area you will also find the latest releases of manuals for our other products, as well as manuals for our historical and obsolete products.

1.4 Disposal of electronic waste



As with most electronic products, this equipment must be disposed of in an environmentally friendly way, and in accordance with existing regulations for electronic waste.

Please contact your FLIR Systems representative for more details.

2 Safety information

Note

Before operating the device, you must read, understand, and follow all instructions, dangers, warnings, cautions, and notes.

Note

FLIR Systems reserves the right to discontinue models, parts or accessories, and other items, or to change specifications at any time without prior notice.

Note

Remove the batteries if the device is not used for an extended period of time.



WARNING

Do not operate the device if you do not have the correct knowledge. Formal qualifications and/or national legislation for the electrical inspections can apply. Incorrect operation of the device can cause damage, shock, injury or death to persons.



WARNING

Do not start the measuring procedure before you have set the function switch to the correct position. This can cause damage to the instrument and can cause injury to persons.



WARNING

Do not change to current or resistance when you measure the voltage. This can cause damage to the instrument and can cause injury to persons.

2 Safety information



WARNING

Do not measure the current on a circuit when the voltage increases to more than 600 V. This can cause damage to the instrument and can cause injury to persons.



WARNING

You must disconnect the test leads from the circuit that you did a test on before you change the range. If you do not do this, damage to the instrument and injury to persons can occur.



WARNING

Do not look directly into the laser beam. The laser beam can cause eye irritation.



WARNING

Do not use the laser pointer near explosive gases or in other possible explosive areas. Injury to persons can occur.



WARNING

Do not replace the batteries or the fuses before you remove the test leads. This can cause damage to the instrument and can cause injury to persons.



WARNING

Do not use the device if the test leads and/or the device show signs of damage. Injury to persons can occur.

2 Safety information



WARNING

Be careful when you do the measurements if the voltages are more than 25 VAC rms or 35 VDC. There is a risk of shock from these voltages. Injury to persons can occur.



WARNING

Do not do diode, resistance or continuity tests before you have removed the power from capacitors and other devices under test during a measurement. Injury to persons can occur.



WARNING

Do not use the device as a tool to identify live terminals. You must use the correct tools. Injury to persons can occur if you do not use the correct tools.



WARNING

Make sure that children cannot touch the device. The device contains dangerous objects and small parts that children can swallow. If a child swallows an object or a part, speak with a physician immediately. Injury to persons can occur.



WARNING

Do not let children play with the batteries and/or the packing material. These can be dangerous for children if they use them as toys.



WARNING

Do not touch expired or damaged batteries without gloves. Injury to persons can occur.

2 Safety information



WARNING

Do not cause a short-circuit of the batteries. This can cause damage to the instrument and can cause injury to persons.



WARNING

Do not put the batteries into a fire. Injury to persons can occur.



CAUTION

Do not use the device for a procedure that it is not made for. This can cause damage to the protection.



This symbol, adjacent to another symbol or terminal, indicates that the user must refer to the manual for further information.



This symbol, adjacent to a terminal, indicates that, under normal use, hazardous voltages may be present.



Double insulation.



UL listing is not an indication or a verification of the accuracy of the meter

2.1 FCC Compliance

This device complies with part 15 of the FCC Rules. Operation is subject to the following two conditions:

1. This device may not cause harmful interference.
2. This device must accept any interference received, including interference that may cause undesired operation.

This equipment has been tested and found to comply with the limits for a Class B digital device, pursuant to part 15 of the FCC Rules. These limits are designed to provide reasonable protection against harmful interference in a residential installation. This equipment generates, uses, and can radiate radio frequency energy

2 Safety information

and, if not installed and used in accordance with the instructions, may cause harmful interference to radio communications. However, there is no guarantee that interference will not occur in a particular installation. If this equipment does cause harmful interference to radio or television reception, which can be determined by turning the equipment off and on, the user is encouraged to try to correct the interference by one or more of the following measures:

- Reorient or relocate the receiving antenna.
- Increase the separation between the equipment and receiver.
- Connect the equipment into an outlet on a circuit different from that to which the receiver is connected.
- Consult the dealer or an experienced radio/TV technician for help.



CAUTION

Exposure to Radio Frequency Radiation.

To comply with FCC/IC RF exposure compliance requirements, a separation distance of at least 20 cm must be maintained between the antenna of this device and all persons. This device must not be co-located or operating in conjunction with any other antenna or transmitter.



WARNING

Changes or modifications not expressly approved by the party responsible for compliance could void the user's authority to operate the equipment.

2.2 Industry Canada compliance

This device complies with Industry Canada licence-exempt RSS standard(s). Operation is subject to the following two conditions: (1) this device may not cause interference, and (2) this device must accept any interference, including interference that may cause undesired operation of the device.

2 Safety information



CAUTION

Exposure to Radio Frequency Radiation.

To comply with RSS 102 RF exposure compliance requirements, for mobile configurations, a separation distance of at least 20 cm must be maintained between the antenna of this device and all persons. This device must not be co-located or operating in conjunction with any other antenna or transmitter.

3 Introduction

Congratulations on your purchase of the FLIR CM78 True RMS Clamp/DMM with infrared thermometer and Bluetooth METERLiNK®.

This meter is supplied in the METERLiNK® kit and includes a Bluetooth module designed for use with FLIR infrared cameras. The combination of a clamp meter and an infrared (IR) camera is used for electrical power measurement, analysis, and documentation.

The FLIR CM78 measurement functions include AC/DC voltage, AC/DC current, resistance, capacitance, frequency, diode test, continuity, type k thermocouple temperature plus non-contact IR temperature.

Proper use and care of this meter will provide many years of reliable service.

3.1 Key features

- True RMS current and voltage measurements.
- Multimeter functions include AC/DC voltage, resistance, capacitance, frequency, diode, and continuity.
- 42 mm (1.7") jaw opening; for conductors up to 2000 MCM.
- 4000-count backlit display.
- Built-in non-contact IR thermometer with laser pointer.
- Features include data hold, minimum/maximum, and auto power off.
- METERLiNK® Bluetooth transmitter wirelessly transmits voltage and current readings to selected FLIR thermal imaging IR cameras, to incorporate meter readings with thermal images.
- Complete with CAT IV-1000V Professional Test Leads, 6 x AAA.
- FLIR CM78 METERLiNK® for Android app for remote meter reading.
- Safety Category Rating: CAT IV-600V, CAT III-1000V

4 Description

4.1 Meter parts

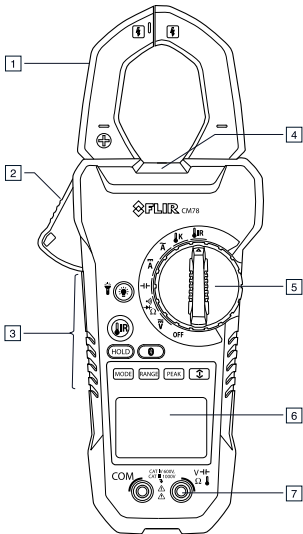

Figure 4.1 Front view

1. Clamp jaw.
2. Jaw opening trigger
3. Function buttons, see section 4.3 *Function buttons*, page 11.
4. Work light.
5. Function switch, see section 4.2 *Function switch*, page 10.
6. LCD display.
7. Probe/thermocouple terminals.

4 Description

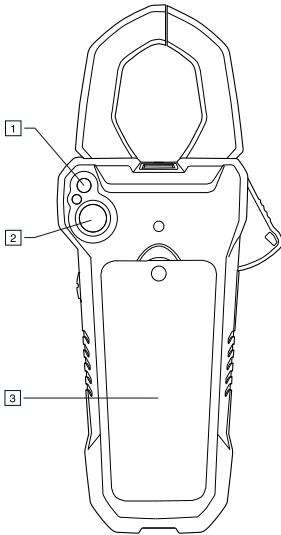





Figure 4.2 Rear view

1. IR sensor.
2. Laser pointer diode.
3. Battery compartment.





4.2 Function switch

\bar{V}	The meter can measure voltage or frequency through the probe inputs. The type of measurement is selected by the MODE button.
Ω	The meter can measure resistance, continuity, or diode polarity through the probe inputs. The type of measurement is selected by the MODE button.
$- $	The meter can measure capacitance through the probe inputs.



4 Description

	The meter can measure DC current through the clamp jaws.
	The meter can measure AC current through the clamp jaws.
	The meter can measure temperature through the thermocouple inputs.
	The meter can measure IR temperature through the IR sensor.
OFF	The meter is in full power-saving mode

4.3 Function buttons

	Press the button to change the operating mode for the currently selected measurement.
	<ul style="list-style-type: none">• Use the button to select Auto range or Manual range mode, see section 5.2 <i>Auto/Manual range</i>, page 14.• In Manual range mode, press the button to change the range (scale).
	<p>The Peak hold function is available when measuring AC/DC current or voltage.</p> <ul style="list-style-type: none">• Press the button to enter Peak hold mode, see section 5.13 <i>Peak hold</i>, page 21.• Press the button to toggle between Pmax and Pmin modes.• Press and hold the button for 2 seconds to return to normal operation.
	<ul style="list-style-type: none">• Press the button to enter MAX/MIN mode, see section 5.12 <i>MAX/MIN mode</i>, page 21.• Press and hold the button for 2 seconds to return to normal operation.
	<ul style="list-style-type: none">• Press the button to enable/disable the display backlight.• Press and hold the backlight/worklight button for 3 seconds. Once released, the backlight will turn on. The same procedure applies to disable.







4 Description

	When the function switch is set to the IR position, press and hold the button to capture IR temperature data.
	Press the button to toggle between Normal and Hold mode. In Hold mode, the display freezes the last reading and continues to display this value.
	Press the button to enable/disable METERLiNK® (Bluetooth) communication, see section .







4.4 Display icons and indicators



Figure 4.3 Display

	Indicates that METERLiNK® (Bluetooth) communication is active, see section.
	Indicates that the IR sensor and the laser pointer diode are active.
	Indicates that the meter is in Auto range mode.
	Indicates that the meter is displaying maximum reading values.
	Indicates that the meter is displaying minimum reading values.
	Indicates that the meter is displaying peak maximum values.
	Indicates that the meter is displaying peak minimum values.

4 Description

	Indicates that the meter is displaying values with relative reference applied (solid indicator) or with no reference applied (flashing indicator).
	Indicates that the meter is in Hold mode.
	Indicates the battery voltage status.
	Indicates that the meter is measuring AC current or voltage.
	Indicates that the meter is measuring DC current or voltage.
	Indicates that the continuity function is active.
	Indicates that the diode test function is active.

4.4.1 Out-of-range warning

If the input is out-of-range, *OL* is displayed on the main display.

5 Operation

Note

Before operating the device, you must read, understand, and follow all instructions, dangers, warnings, cautions, and notes.

Note

When the meter is not in use, the function switch should be set to the **OFF** position.

Note

When connecting the probe leads to the device under test, connect the negative lead before connecting the positive lead. When removing the probe leads, remove the positive lead before removing the negative lead.

5.1 Powering the meter

1. Set the function switch to any position to switch on the meter.
2. If the battery indicator  shows that the battery voltage is low or if the meter does not power on, replace the batteries. See section 6.2 *Battery replacement*, page 24.

5.1.1 Auto power off

The meter enters sleep mode after 25 minutes of inactivity. To turn on the meter again, set the function switch to *OFF* and then set it to any position again. The auto power off time-out is then reset.

5.2 Auto/Manual range

In Auto range mode, the meter automatically selects the most appropriate measurement scale. In Manual range mode, the desired range (scale) is set manually. Auto range is the default method of operation. When any new function is selected with the function switch, the starting mode is Auto range, and the  indicator is displayed.

5 Operation

To enter Manual range mode, press the **RANGE** button. To change the range, press the **RANGE** button repeatedly until the desired range is displayed.

To return to Auto range mode, press and hold the **RANGE** button until the **A** indicator is displayed.

5.3 Current measurements

When measuring current using the clamp jaws, only one conductor should be enclosed by the jaws—refer to Figure 5.1.

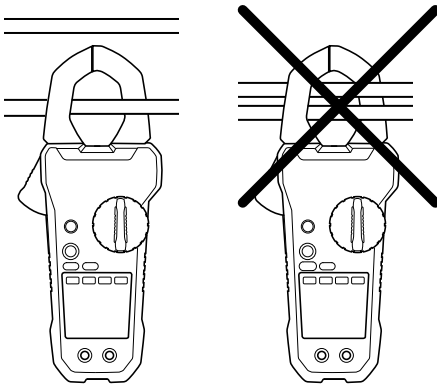

Figure 5.1 Correct and incorrect set-up

1. Ensure that the probe/thermocouple leads are disconnected from the meter.
2. Set the function switch to the $\overline{\text{A}}$ or $\tilde{\text{A}}$ position.

The  or  indicator is displayed.

3. Press the trigger to open the clamp jaws. Fully enclose one conductor—refer to Figure 5.1. For optimum results, center the conductor in the jaws.
4. Read the current value on the display.









5 Operation

Note



The meter can also be set to display peak values only, see section 5.13 *Peak hold*, page 21.

5.3.1 DC Zero

The DC Zero feature removes offset values and improves the accuracy of DC current measurements.

1. Set the function switch to the $\overline{\text{A}}$ position.
2. Ensure that there is no conductor in the clamp jaws.
3. Press the  button to enter the DC Zero mode and store the offset value. The  indicator is displayed.
4. Use the  button to toggle the display between offset applied (solid ) and no offset applied (flashing ) indicator).
5. To exit the DC Zero mode, press and hold the  button. The  indicator disappears and the  indicator is displayed.

5.4 Voltage measurements

1. Set the function switch to the $\overline{\text{V}}$ position.
2. Insert the black probe lead into the negative COM terminal and the red probe lead into the positive V terminal.
3. Use the  button to select AC or DC voltage measurement.
 - The  indicator should be displayed for AC voltage measurements.
 - The  indicator should be displayed for DC voltage measurements.
4. Connect the probe leads in parallel to the part under test.
5. Read the voltage value on the display.

Note

The meter can also be set to display peak values only, see section 5.13 *Peak hold*, page 21.

5 Operation

5.5 Resistance measurements



WARNING

Do not do diode, resistance or continuity tests before you have removed the power from capacitors and other devices under test during a measurement. Injury to persons can occur.





1. Set the function switch to the Ω position.
2. Insert the black probe lead into the negative COM terminal and the red probe lead into the positive Ω terminal.
3. Touch the tips of the probe across the circuit or component under test.
4. Read the resistance value on the display.

5.6 Capacitance measurements



WARNING

Do not take capacitance measurements before you have removed the power from the capacitor or other device or circuit during a test. Injury to persons can occur.

1. Set the function switch to the $\text{—}||$ position.
2. Insert the black probe lead into the negative COM terminal and the red probe lead into the positive $\text{—}||$ terminal.
3. Press the **MODE** button to zero any stray capacitance. The relative reference is stored and the  indicator is displayed.
4. Touch the tips of the probe across the part under test.
5. Read the capacitance value on the display.
6. Use the **MODE** button to toggle the display between relative reference applied (solid  indicator) and no reference applied (flashing  indicator).
7. To exit the zero (relative) mode, press and hold the **MODE** button. The  indicator disappears and the  indicator is displayed.

5 Operation

Note

For very large capacitance values, it may take several minutes for the measurement to settle and the final reading to stabilize.

5.7 Frequency measurements

1. Set the function switch to the \overline{V} position.
2. Insert the black probe lead into the negative COM terminal and the red probe lead into the positive V terminal.
3. Press and hold the **MODE** button to select frequency measurement. The Hz unit indicator should be displayed.
4. Touch the tips of the probe across the part under test.
5. Read the frequency value on the display.

5.8 Type K temperature measurements

1. Set the function switch to the $\downarrow K$ position.
2. While observing the correct polarity, insert the thermocouple leads into the negative COM terminal and the positive \downarrow terminal.
3. Touch the tip of the thermocouple to the part under test. Keep the thermocouple tip on the part until the reading on the display stabilizes.
4. Read the temperature value on the display.
5. To avoid electrical shock, disconnect the thermocouple leads before turning the function switch to another position.

Note

To change the temperature unit, see section 5.14 *Temperature units*, page 22.

5.9 Continuity



WARNING

Do not do diode, resistance or continuity tests before you have removed the power from capacitors and other devices under test during a measurement. Injury to persons can occur.

1. Set the function switch to the Ω position.
-

5 Operation

2. Insert the black probe lead into the negative COM terminal and the red probe lead into the positive Ω terminal.
3. Use the **(MODE)** button to select continuity measurement. The  indicator should be displayed.
4. Touch the tips of the probe across the circuit or component under test.
5. If the resistance is less than 30 Ω , the meter beeps continuously.

5.10 Diode test



WARNING

Do not do diode, resistance or continuity tests before you have removed the power from capacitors and other devices under test during a measurement. Injury to persons can occur.

1. Set the function switch to the Ω position.
2. Insert the black probe lead into the negative COM terminal and the red probe lead into the positive Ω terminal.
3. Use the **(MODE)** button to select the diode test function. The  indicator should be displayed.
4. Touch the tips of the probe across the diode or semiconductor junction under test. Make a note of the value on the display.
5. Reverse the red and black test lead positions to reverse the test polarity.
6. Touch the tips of the probe across the diode or semiconductor junction under test. Make a note of the new value on the display.
7. The diode or semiconductor junction can be evaluated as follows:
 - If one of the readings displays a value (typically 0.400 V or 0.900 V) and the other reading displays *OL*, the component is good.
 - If both readings display *OL*, the component is open.
 - If both readings are very small or 0, the component is shorted.

5.11 IR temperature measurements

The meter is equipped with a laser pointer diode, which is used as a targeting pointer for the IR temperature measurements. The target of the measurement should be larger than the size of the laser beam spot. As the distance from an object increases, the spot size of the area measured by the meter becomes larger. The meter's field of view ratio is 8:1, meaning that if the meter is 8 inches (20 cm)

5 Operation

from the target, the diameter (spot) of the object under test must be at least 1 inch (2.54 cm). Refer to Figure 5.2.

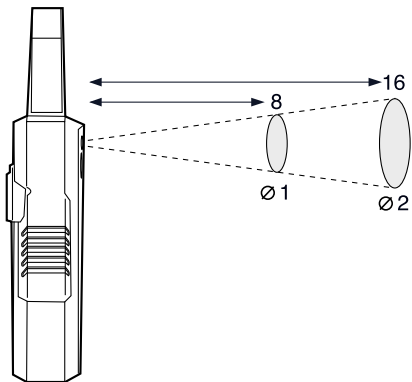

Figure 5.2 IR spot-to-distance ratio

IR measurement notes:

- The object under test should be larger than the size of the laser beam spot.
- If the surface of the object under test is covered with frost, oil, grime, etc., clean the surface before measuring.
- If the surface of the object is highly reflective, apply masking tape or flat black paint to the surface before measuring.
- The meter may not make accurate measurements through transparent surfaces such as glass.
- Steam, dust, smoke, etc., may obscure measurements.
- To find a hot spot, aim the meter outside the area of interest, then scan across (in an up and down motion) until the hot spot is located.



WARNING



Do not look directly into the laser beam. The laser beam can cause eye irritation.

5 Operation



WARNING

Do not use the laser pointer near explosive gases or in other possible explosive areas. Injury to persons can occur.









1. Set the function switch to the  IR position.
2. Press and hold the  button to enable the IR sensor and the laser pointer diode.
The  indicator is displayed.
3. Aim the laser pointer at the surface to be measured. Read the IR temperature value on the display.

Note

To change the temperature unit, see section 5.14 *Temperature units*, page 22.

5.12 MAX/MIN mode

The MAX/MIN mode is available for the AC/DC Voltage/Current, Resistance, Capacitance, Type K Temperature, and IR Temperature functions.





1. Press the  button to activate the MAX/MIN recording mode; the  will appear. The meter will display and hold the maximum reading and will update only when a new “max” reading is registered.
2. Press the  button again and the  will appear. The meter will now display and hold the minimum reading and will update only when a new “min” occurs.
3. Press the  button again and two blinking arrows   will appear. The meter will now display the present reading, but will continue to track the “max” and “min” readings.
4. To exit MAX/MIN mode, press and hold the  button for 2 seconds; the arrow indicators should switch OFF.

5.13 Peak hold

With the Peak hold function active, the meter captures and displays the positive and negative peak values and updates only when a higher/lower value is

5 Operation

registered. The Peak hold function is available when measuring AC/DC current or voltage.

1. With the meter set to AC/DC current or voltage measurement (see section 5.3 *Current measurements*, page 15 or 5.4 *Voltage measurements*, page 16) press the  button to enter Peak mode.
2. Press the  button toggle between Pmax and Pmin modes.
 - In Pmax mode, the  indicator is displayed.
 - In Pmin mode, the  indicator is displayed.
3. Read the positive/negative peak value on the display.
4. To return to normal operation, press and hold the  button for 2 seconds.

5.14 Temperature units

The meter displays temperatures in °C or °F. The temperature unit switch is located in the battery compartment.

1. To avoid electrical shock, disconnect the meter if connected to a circuit, remove the probe/thermocouple leads from the terminals, and set the function switch to the **OFF** position before attempting to switch the temperature unit.
2. Unscrew the battery compartment cover and remove the batteries.
3. Set the temperature unit switch to the desired position.
4. Fit the batteries in place and secure the battery compartment cover.

5.15 Streaming measurement data using Bluetooth

5.15.1 General

Some IR cameras from FLIR Systems support Bluetooth communication, and to those cameras you can stream measurement data from the meter. The data is then merged into the result table in the IR image.

Streaming measurement data is a convenient way to add important information to an IR image. For example, when identifying an overheated cable connection, you may want to know the current in that cable.

The Bluetooth range is 10 m (32 ft.) maximum.

5 Operation

5.15.2 Procedure

1. Pair the IR camera with the instrument. Refer to the camera manual for information on how to pair Bluetooth devices.
2. Turn on the camera.
3. Turn on the meter.
4. Press the  on the meter to enable Bluetooth.
5. Choose the variable that you want to use (voltage, current, resistance, etc.). Results from the meter will now automatically be displayed in the result table in the top left corner of the IR camera screen.

Note

The meter's internal update rate is faster than that of the Bluetooth data transmission rate; therefore, values displayed on the remote device may differ slightly from the values displayed on the meter.

6 Maintenance

6.1 Cleaning and storage

Clean the meter with a damp cloth and mild detergent; do not use abrasives or solvents.

If the meter is not to be used for an extended period, remove the batteries and store them separately.

6.2 Battery replacement

1. To avoid electrical shock, disconnect the meter if connected to a circuit, remove the probe/thermocouple leads from the terminals, and set the function switch to the **OFF** position before attempting to replace the batteries.
2. Unscrew and remove the battery compartment cover.
3. Replace the six standard AAA batteries, observing correct polarity.
4. Secure the battery compartment cover.

6.2.1 Disposal of electronic waste



As with most electronic products, this equipment must be disposed of in an environmentally friendly way, and in accordance with existing regulations for electronic waste.

Please contact your FLIR Systems representative for more details.

7 Technical specifications

7.1 General specifications

Display	4000-count with bar
Controls	<ul style="list-style-type: none">• 8-position rotary switch• Dedicated IR button• 8 dedicated function buttons: flashlight, IR, maximum/minimum, Bluetooth, hold, range, mode, peak
Backlight	White LED
Work light	White LED array
Measurement ranges	See section 7.2 <i>Electrical range specifications</i> , page 26.
Sample rate	20 per second, nominal
Input impedance	10 M Ω (VDC and VAC)
AC voltage bandwidth	45–400 Hz
Power supply	6 \times AAA (LR03) batteries
Battery life	100 hours, using alkaline batteries
Auto power off (APO)	After 25 minutes (nominal) inactivity; reset when the rotary switch is set to <i>OFF</i> , then set to any position again
APO quiescent current	50 μ A maximum
Over-current protection fuse	No fuse
Measurement type	True RMS, crest factor ≤ 3 at full scale up to 500 V, decreasing linearly to ≤ 1.5 at 1000 V
Continuity test	Visual and audible. Threshold is 30 Ω

7 Technical specifications

Other indications	Low battery, over-range, IR, memory
Operating temperature	-10 to 50°C (14 to 122°F)
Storage temperature	-25 to 60°C (-14 to 140°F)
Operating humidity	Maximum 90% up to 35°C (95°F) decreasing linearly to 60% at 45°C (113°F)
Storage humidity	90% maximum
Dimensions	257 mm × 110 mm × 50 mm (10.1" × 4.3" × 2.0")
Weight	0.63 kg (1.4 lb.)
Bluetooth range	10m (32ft) maximum
Safety Category Rating	CAT IV-600V, CAT III-1000V

7.2 Electrical range specifications

Valid for ambient temperature conditions 18 to 28 °C (64.4 to 82.4 °F)

Function	Range	Resolution	Accuracy (of reading)
AC current	400.0 A	0.1 A	±(2.5% + 8 digits)
	1000 A	1 A	±(2.8% + 5 digits)
DC current	400.0 A	0.1 A	±(2.5% + 5 digits)
	1000 A	1 A	±(2.8% + 5 digits)

7 Technical specifications

Function	Range	Resolution	Accuracy (of reading)
AC voltage	400.0 mV	0.1 mV	$\pm(1.5\% + 10 \text{ digits})$
	4.000 V	0.001 V	$\pm(1.5\% + 5 \text{ digits})$
	40.00 V	0.01 V	
	400.0 V	0.1 V	
	1000 V	1 V	$\pm(2.0\% + 5 \text{ digits})$
<p>Note All AC voltage ranges are specified from 5% of the range to 100% of the range.</p>			
DC voltage	400.0 mV	0.1 mV	$\pm(1.5\%+10 \text{ digits})$
	4.000 V	0.001 V	$\pm(1.5\% + 2 \text{ digits})$
	40.00 V	0.01 V	
	400.0 V	0.1 V	
	1000 V	1 V	$\pm(2.0\% + 2 \text{ digits})$
Resistance	400.0 Ω	0.1 Ω	$\pm(1.0\% + 4 \text{ digits})$
	4.000 k Ω	0.001 k Ω	$\pm(1.5\% + 2 \text{ digits})$
	40.00 k Ω	0.01 k Ω	
	400.0 k Ω	0.1 k Ω	
	4.000 M Ω	0.001 M Ω	$\pm(2.5\% + 3 \text{ digits})$
	40.00 M Ω	0.01 M Ω	$\pm(3.5\% + 5 \text{ digits})$

7 Technical specifications

Function	Range	Resolution	Accuracy (of reading)
Capacitance	4.000 nF	0.001 nF	$\pm(5.0\% + 30$ digits)
	40.00 nF	0.01 nF	$\pm(5.0\% + 20$ digits)
	400.0 nF	0.1 nF	$\pm(3.0\% + 5$ digits)
	4.000 μ F	0.001 μ F	
	40.00 μ F	0.01 μ F	
	400.0 μ F	0.1 μ F	$\pm(4.0\% + 10$ digits)
	4.000 mF	0.001 mF	$\pm(10\% + 10$ digits)
	40.00 mF	0.01 mF	Unspecified
Frequency	4.000 kHz	0.001 kHz	$\pm(1.5\% + 2$ digits)
	Sensitivity: 100 V (<50 Hz); 50 V (50–400 Hz); 5 V (401–4000 Hz)		

7 Technical specifications

7.3 Thermal range specifications

Function	Thermocouple range	IR range	Accuracy (of reading)
IR temperature (8:1 ratio)		-29 to -20°C (-20 to -4°F)	±5°C (±9°F)
		-20 to 270°C (-4 to 518°F)	±2.0% reading or ±2°C (±4°F) (whichever is greater)
Type K inputs (excluding probe)	-20 to 760°C (-4 to 1400°F)		±(3% rdg + 5°C) (±(3% rdg + 9°F))

7.4 Maximum input specifications

Function	Maximum input
AC voltage, DC voltage	1000 V DC/AC
Thermocouple	1000 V DC/AC
Resistance, capacitance, frequency, diode test	1000 V DC/AC

8 Technical support

Website	http://www.flir.com/test
Technical support	T&MSupport@flir.com
Repairs	Repair@flir.com
Phone number	+1 855-499-3662 (toll-free)

9 Warranties

9.1 FLIR Global Limited Lifetime Warranty

A qualifying FLIR Test and Measurement product (the "Product") purchased either directly from FLIR Commercial Systems Inc and affiliates (FLIR) or from an authorized FLIR distributor or reseller that Purchaser registers on-line with FLIR is eligible for coverage under FLIR's Limited Lifetime Warranty, subject to the terms and conditions in this document. This warranty only applies to purchases of Qualifying Products (see below) purchased and manufactured after April 1, 2013.

PLEASE READ THIS DOCUMENT CAREFULLY; IT CONTAINS IMPORTANT INFORMATION ABOUT THE PRODUCTS THAT QUALIFY FOR COVERAGE UNDER THE LIMITED LIFETIME WARRANTY, PURCHASER'S OBLIGATIONS, HOW TO ACTIVATE THE WARRANTY, WARRANTY COVERAGE, AND OTHER IMPORTANT TERMS, CONDITIONS, EXCLUSIONS AND DISCLAIMERS.

1. PRODUCT REGISTRATION. To qualify for FLIR's Limited Lifetime Warranty, Purchaser must fully register the Product directly with FLIR on-line at <http://www.flir.com> within Sixty (60) DAYS of the date the Product was purchased by the first retail customer (the "Purchase Date"). Qualifying PRODUCTS THAT ARE NOT REGISTERED ON-LINE WITHIN SIXTY (60) DAYS OF THE PURCHASE DATE WILL HAVE A LIMITED ONE YEAR WARRANTY FROM DATE OF PURCHASE.

2. QUALIFYING PRODUCTS. Upon registration, Test and Measurement products that qualify for coverage under FLIR's Limited Lifetime Warranty are: MR7x, CM7x, CM8x, DMxx, VP5x not including accessories which may have their own warranty.

3. WARRANTY PERIODS. For purposes of the The Limited Lifetime Warranty, Lifetime is defined as seven years (7) after the product is no longer manufactured, or ten years (10) from date of purchase, whichever is greater. This Warranty is only applicable to the original owner of the Products.

Any Product that is repaired or replaced under warranty is covered under this Limited Lifetime Warranty for one hundred eighty days (180) days from the date of return shipment by FLIR or for the remaining duration of the applicable Warranty Period, whichever is longer.

4. LIMITED WARRANTY. In accordance with the terms and conditions of this Limited Lifetime Warranty, and except as excluded or disclaimed in this document, FLIR warrants, from the Purchase Date, that all fully registered Products will conform to FLIR's published Product specifications and be free from defects in materials and workmanship during the applicable Warranty Period. PURCHASER'S SOLE AND EXCLUSIVE REMEDY UNDER THIS WARRANTY, AT FLIR'S SOLE DISCRETION, IS THE REPAIR OR REPLACEMENT OF

DEFECTIVE PRODUCTS IN A MANNER, AND BY A SERVICE CENTER, AUTHORIZED BY FLIR. IF THIS REMEDY IS ADJUDICATED TO BE INSUFFICIENT, FLIR SHALL REFUND PURCHASER'S PAID PURCHASE PRICE AND HAVE NO OTHER OBLIGATION OR LIABILITY TO BUYER WHATSOEVER.

5. WARRANTY EXCLUSIONS AND DISCLAIMERS. FLIR MAKES NO OTHER WARRANTY OF ANY KIND WITH RESPECT TO THE PRODUCTS. ALL OTHER WARRANTIES, EXPRESS OR IMPLIED, INCLUDING BUT NOT LIMITED TO IMPLIED WARRANTIES OF MERCHANTABILITY, FITNESS FOR A PARTICULAR PURPOSE (EVEN IF PURCHASER HAS NOTIFIED FLIR OF ITS INTENDED USE FOR THE PRODUCTS), AND NON-INFRINGEMENT ARE EXPRESSLY EXCLUDED FROM THIS AGREEMENT.

THIS WARRANTY EXPRESSLY EXCLUDES ROUTINE PRODUCT MAINTENANCE, SOFTWARE UPDATES, AND REPLACEMENT OF MANUALS, FUSES, OR DISPOSABLE BATTERIES. FLIR FURTHER EXPRESSLY DISCLAIMS ANY WARRANTY COVERAGE WHERE THE ALLEGED NONCONFORMITY IS DUE TO NORMAL WEAR AND TEAR, OTHER ALTERATION, MODIFICATION, REPAIR, ATTEMPTED REPAIR, IMPROPER USE, IMPROPER MAINTENANCE, NEGLIGENCE, ABUSE, IMPROPER STORAGE, FAILURE TO FOLLOW ANY PRODUCT INSTRUCTIONS, DAMAGE (WHETHER CAUSED BY ACCIDENT OR OTHERWISE), OR ANY OTHER IMPROPER CARE OR HANDLING OF THE PRODUCTS CAUSED BY ANYONE OTHER THAN FLIR OR FLIR'S EXPRESSLY AUTHORIZED DESIGNEE.

THIS DOCUMENT CONTAINS THE ENTIRE WARRANTY AGREEMENT BETWEEN PURCHASER AND FLIR AND SUPERSEDES ALL PRIOR WARRANTY NEGOTIATIONS, AGREEMENTS, PROMISES AND UNDERSTANDINGS BETWEEN PURCHASER AND FLIR. THIS WARRANTY MAY NOT BE ALTERED WITHOUT THE EXPRESS WRITTEN CONSENT OF FLIR.

6. WARRANTY RETURN, REPAIR AND REPLACEMENT. To be eligible for warranty repair or replacement, Purchaser must notify FLIR within thirty (30) days of discovering of any apparent defect in materials or workmanship. Before Purchaser may return a Product for warranty service or repair, Purchaser must first obtain a returned material authorization (RMA) number from FLIR. To obtain the RMA number Owner must provide an original proof of purchase. For additional information, to notify FLIR of an apparent defect in materials or workmanship, or to request an RMA number, visit <http://www.flir.com>. Purchaser is solely responsible for complying with all RMA instructions provided by FLIR including but not limited to adequately packaging the Product for shipment to FLIR and for all packaging and shipping costs. FLIR will pay for returning to Purchaser any Product that FLIR repairs or replaces under warranty.

9 Warranties

FLIR reserves the right to determine, in its sole discretion, whether a returned Product is covered under Warranty. If FLIR determines that any returned Product is not covered under Warranty or is otherwise excluded from Warranty coverage, FLIR may charge Purchaser a reasonable handling fee and return the Product to Purchaser, at Purchaser's expense, or offer Purchaser the option of handling the Product as a non-warranty return.

7. NON-WARRANTY RETURN. Purchaser may request that FLIR evaluate and service or repair a Product not covered under warranty, which FLIR may agree to do in its sole discretion. Before Purchaser returns a Product for non-warranty evaluation and repair, Purchaser must contact FLIR by visiting <http://www.flir.com> to request an evaluation and obtain an RMA. Purchaser is solely responsible for complying with all RMA instructions provided by FLIR including but not limited to adequately packaging the Product for shipment to FLIR and for all packaging and shipping costs. Upon receipt of an authorized non-warranty return, FLIR will evaluate the Product and contact Purchaser regarding the feasibility of and the costs and fees associated with Purchaser's request. Purchaser shall be responsible for the reasonable cost of FLIR's evaluation, for the cost of any repairs or services authorized by Purchaser, and for the cost of repackaging and returning the Product to Purchaser.

Any non-warranty repair of a Product is warranted for one hundred eighty days (180) days from the date of return shipment by FLIR to be free from defects in materials and workmanship only, subject to all of the limitations, exclusions and disclaimers in this document.

9.2 FLIR Test and Measurement Limited 2 Year Warranty

A qualifying FLIR Test and Measurement product (the "Product") purchased either directly from FLIR Commercial Systems Inc and affiliates (FLIR) or from an authorized FLIR distributor or reseller that Purchaser registers on-line with FLIR is eligible for coverage under FLIR's Limited Warranty, subject to the terms and conditions in this document. This warranty only applies to purchases of Qualifying Products (see below) purchased and manufactured after April 1, 2013.

PLEASE READ THIS DOCUMENT CAREFULLY; IT CONTAINS IMPORTANT INFORMATION ABOUT THE PRODUCTS THAT QUALIFY FOR COVERAGE UNDER THE LIMITED WARRANTY, PURCHASER'S OBLIGATIONS, HOW TO ACTIVATE THE WARRANTY, WARRANTY COVERAGE, AND OTHER IMPORTANT TERMS, CONDITIONS, EXCLUSIONS AND DISCLAIMERS.

1. PRODUCT REGISTRATION. To qualify for FLIR's Limited Warranty, Purchaser must fully register the Product directly with FLIR on-line at <http://www.flir.com> within Sixty (60) DAYS of the date the Product was purchased by the first retail customer (the "Purchase Date"). Qualifying PRODUCTS THAT ARE NOT REGISTERED ON-LINE

WITHIN SIXTY (60) DAYS OF THE PURCHASE DATE WILL HAVE A LIMITED ONE YEAR WARRANTY FROM DATE OF PURCHASE.

2. QUALIFYING PRODUCTS. Upon registration, Test and Measurement products that qualify for coverage under FLIR's Limited Warranty are: VS70 Videoscope, VSAxx Articulation Camera, VSCxx Camera, VSSxx Probe Spool, VST handset, MR02 Pin Extension Probe, and TAxX not including accessories which may have their own warranty.

3. WARRANTY PERIODS. The applicable Limited Warranty Period measured from the Purchase data are:

Products	Limited Warranty Period
VS70, VSAxx, VSCxx, VSSxx, VST, MR02, TAxX	TWO (2) Years

Any Product that is repaired or replaced under warranty is covered under this Limited Warranty for one hundred eighty days (180) days from the date of return shipment by FLIR or for the remaining duration of the applicable Warranty Period, whichever is longer.

4. LIMITED WARRANTY. In accordance with the terms and conditions of this Limited Warranty, and except as excluded or disclaimed in this document, FLIR warrants, from the Purchase Date, that all fully registered Products will conform to FLIR's published product specifications and be free from defects in materials and workmanship during the applicable Warranty Period. PURCHASER'S SOLE AND EXCLUSIVE REMEDY UNDER THIS WARRANTY, AT FLIR'S SOLE DISCRETION, IS THE REPAIR OR REPLACEMENT OF DEFECTIVE PRODUCTS IN A MANNER, AND BY A SERVICE CENTER, AUTHORIZED BY FLIR. IF THIS REMEDY IS ADJUDICATED TO BE INSUFFICIENT, FLIR SHALL REFUND PURCHASER'S PAID PURCHASE PRICE AND HAVE NO OTHER OBLIGATION OR LIABILITY TO BUYER WHATSOEVER.

5. WARRANTY EXCLUSIONS AND DISCLAIMERS. FLIR MAKES NO OTHER WARRANTY OF ANY KIND WITH RESPECT TO THE PRODUCTS. ALL OTHER WARRANTIES, EXPRESS OR IMPLIED, INCLUDING BUT NOT LIMITED TO IMPLIED WARRANTIES OF MERCHANTABILITY, FITNESS FOR A PARTICULAR PURPOSE (EVEN IF PURCHASER HAS NOTIFIED FLIR OF ITS INTENDED USE FOR THE PRODUCTS), AND NON-INFRINGEMENT ARE EXPRESSLY EXCLUDED FROM THIS AGREEMENT.

THIS WARRANTY EXPRESSLY EXCLUDES ROUTINE PRODUCT MAINTENANCE, SOFTWARE UPDATES, AND REPLACEMENT OF FUSES, OR DISPOSABLE BATTERIES. FLIR FURTHER EXPRESSLY DISCLAIMS ANY WARRANTY COVERAGE WHERE THE ALLEGED NONCONFORMITY IS DUE TO NORMAL WEAR AND TEAR, OTHER ALTERATION, MODIFICATION, REPAIR, ATTEMPTED REPAIR, IMPROPER USE, IMPROPER

9 Warranties

MAINTENANCE, NEGLIGENCE, ABUSE, IMPROPER STORAGE, FAILURE TO FOLLOW ANY PRODUCT INSTRUCTIONS, DAMAGE (WHETHER CAUSED BY ACCIDENT OR OTHERWISE), OR ANY OTHER IMPROPER CARE OR HANDLING OF THE PRODUCTS CAUSED BY ANYONE OTHER THAN FLIR OR FLIR'S EXPRESSLY AUTHORIZED DESIGNEE.

THIS DOCUMENT CONTAINS THE ENTIRE WARRANTY AGREEMENT BETWEEN PURCHASER AND FLIR AND SUPERSEDES ALL PRIOR WARRANTY NEGOTIATIONS, AGREEMENTS, PROMISES AND UNDERSTANDINGS BETWEEN PURCHASER AND FLIR. THIS WARRANTY MAY NOT BE ALTERED WITHOUT THE EXPRESS WRITTEN CONSENT OF FLIR.

6. WARRANTY RETURN, REPAIR AND REPLACEMENT.

To be eligible for warranty repair or replacement, Purchaser must notify FLIR within thirty (30) days of discovering of any apparent defect in materials or workmanship. Before Purchaser may return a Product for warranty service or repair, Purchaser must first obtain a returned material authorization (RMA) number from FLIR. To obtain the RMA number Owner must provide an original proof of purchase. For additional information, to notify FLIR of an apparent defect in materials or workmanship, or to request an RMA number, visit <http://www.flir.com>. Purchaser is solely responsible for complying with all RMA instructions provided by FLIR including but not limited to adequately packaging the Product for shipment to FLIR and for all packaging and shipping costs. FLIR will pay for returning to Purchaser any Product that FLIR repairs or replaces under warranty.

FLIR reserves the right to determine, in its sole discretion, whether a returned Product is covered under Warranty. If FLIR determines that any returned Product is not covered under Warranty or is otherwise excluded from Warranty coverage, FLIR may charge Purchaser a reasonable handling fee and return the Product to Purchaser, at Purchaser's expense, or offer Purchaser the option of handling the Product as a non-warranty return.

7. NON-WARRANTY RETURN. Purchaser may request that FLIR evaluate and service or repair a Product not covered under warranty, which FLIR may agree to do in its sole discretion. Before Purchaser returns a Product for non-warranty evaluation and repair, Purchaser must contact FLIR by visiting <http://www.flir.com> to request an evaluation and obtain an RMA. Purchaser is solely responsible for complying with all RMA instructions provided by FLIR including but not limited to adequately packaging the Product for shipment to FLIR and for all packaging and shipping costs. Upon receipt of an authorized non-warranty return, FLIR will evaluate the Product and contact Purchaser regarding the feasibility of and the costs and fees associated with Purchaser's request. Purchaser shall be responsible for the reasonable cost of FLIR's evaluation, for the cost of any repairs or services authorized by Purchaser, and for the cost of repackaging and returning the Product to Purchaser.

Any non-warranty repair of a Product is warranted for one hundred eighty days (180) days from the date of return shipment by FLIR to be free from defects in materials and workmanship only, subject to all of the limitations, exclusions and disclaimers in this document.

A note on the technical production of this publication

This publication was produced using XML — the eXtensible Markup Language. For more information about XML, please visit <http://www.w3.org/XML/>

A note on the typeface used in this publication

This publication was typeset using Linotype Helvetica™ World. Helvetica™ was designed by Max Miedinger (1910–1980)

LOEF (List Of Effective Files)

T501021.xml; en-US; AE; 10032; 2013-11-21

T505544.xml; en-US; 9030; 2013-09-18



Corporate Headquarters

FLIR Systems, Inc.
27700 SW Parkway Ave.
Wilsonville, OR 97070
USA
Telephone: +1-503-498-3547

Website

<http://www.flir.com>

Customer support

<http://support.flir.com>

Publ. No.: T559826
Release: AE
Commit: 10032
Head: 10032
Language: en-US
Modified: 2013-11-21
Formatted: 2013-11-21



T559826

