

# Battery Capacity Tester

Model BT100

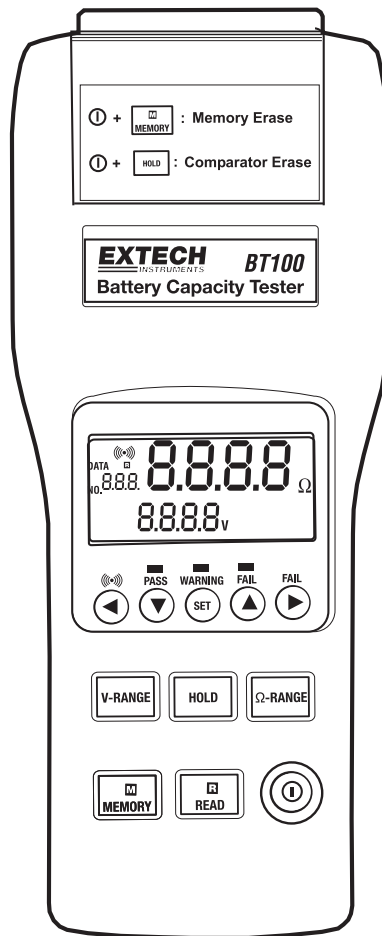

## ***Introduction***

---

Thank you for selecting the Extech Model BT100. The Battery Tester is designed for measuring the internal resistance and output voltage of batteries including lead storage cells, nickel-cadmium batteries, lithium-ion batteries, and nickel-metal hydride batteries.



## ***Features***

- Accurate results are achieved using a four-terminal measurement method that eliminates lead and contact resistance.
- 1kHz test current with up to 10 $\mu\Omega$  resistance resolution.
- Dual display simultaneously indicates the internal resistance and the battery voltage.
- Comparator function with storage of up to 99 sets of resistance and voltage data for battery deterioration characterization.
- Pin type and alligator type 4-terminal Kelvin leads for quick and accurate resistance measurements.
- Memory capacity to store up to 999 (manual datalogging) or 9600 (automatic datalogging) data points.
- Supplied RS232 PC port and Windows compatible software.

## ***Safety***

### **International Safety Symbols**

---

-  This symbol, adjacent to another symbol or terminal, indicates the user must refer to the manual for further information.
-  This symbol, adjacent to a terminal, indicates that, under normal use, hazardous voltages may be present
-  Double insulation

## Meter Description

1. **ⓘ** Power button: Power ON/OFF
2. **R** READ button:
  - ① Press **R** button to start manually logging readings.
  - ② Press **R** READ button again to stop logging.
3. **M** MEMORY button:
  - ① Under the manual logging mode, the tester stores a single set of logged readings to the memory by pressing **M** MEMORY button.
  - ② Press and hold **M** MEMORY button for 2 seconds to enter continuous (automatic) logging mode. Press again to stop logging.
4. **V-RANGE** button: Select the voltage range. (4V, 40V)
5. **HOLD** button:
  - ① Press HOLD to freeze or unfreeze the displayed reading.
  - ② Press and hold the HOLD button for 2 seconds then release, to enter the interval time (sample rate) setting for continuous data logging. Set from 1 to 255 seconds. Press Set button to save and exit.
6. **Ω - RANGE** button: Select the resistance range. (40mΩ, 400mΩ, 4Ω, 40Ω)
7. **▶ REL** button:
  - ① Press ▶ to move the cursor to the right.
  - ② Press REL (Relative) to zero the reading.
8. **▲** button: Press ▲ to increase the displayed value.
9. **SET** button:
  - ① **Press SET to switch the comparator mode on or off.**
  - ② Press and hold the SET button for 2 seconds to enter the comparator-setting mode. Press again to store the setting in memory.
10. **▼** button: Press ▼ to decrease the displayed value.
11. **◀ 🔔** Button:
  - ① Press ◀ to move the cursor to the left.
  - ② Press 🔔 to switch the audible tone on or off.
12. **RS-232 connector**: PC interface connector.
13. **- Input jack**: Black test lead plug connection.
14. **+ Input jack**: Red test lead plug connection.
15. **LCD display** (LED test status indicators are located below the LCD display)
16. **AC adaptor input**

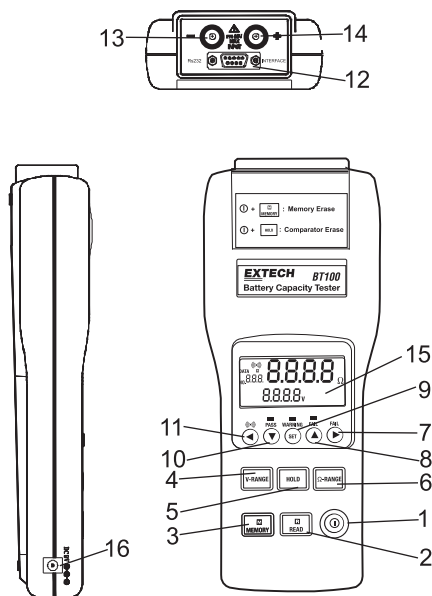

## Display Description

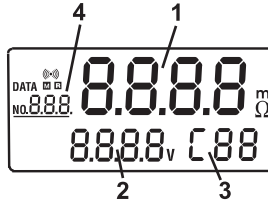

1. Measured resistance reading (or High/Low resistance limit when setting up the comparator)
2. Measured voltage reading (or High/Low voltage limit when setting up the comparator)
3. The comparator set number (there are 99 sets total)
4. The memory location for manually logged data.

### Symbols:

mΩ: Milliohm (resistance)

V: Voltage

[HOLD]: Hold function (display freeze)

[COMP]: Comparator function enabled

[BT]: Low-Battery

[Beeper icon]: Beeper enabled

[DATA R]: Manual datalogging enabled

[M]: Continuous datalogging enabled (flashes each time data is stored)

INTV: Interval time setting for the continuous datalogging function. (1 to 255 seconds)

[COMP.SET]: Comparator settings mode

HIGH: High limit setting (threshold) for the comparator

LOW: Low limit setting (threshold) for the comparator

### LED Test Status Indicators

PASS (green LED): Battery is good (within the tolerances of the comparator's preset limits)

WARNING (yellow LED): Battery is beginning to deteriorate

FAIL (red LED): Battery has failed

The LED status indications listed above are active when the High/Low comparator limits for internal resistance and the comparator threshold value for voltage are properly configured.

## Operation

---

### Preparation and Safety

The following safety information must be observed to ensure maximum personal safety during the operation of this tester.

- To avoid electric shock when replacing the batteries: Disconnect the test leads from the device under test before attempting to replace the batteries.
- Check the battery polarity carefully when inserting the batteries. Refer to the battery replacement section (under Maintenance) later in this User Guide.
- Be sure to dispose of used batteries properly.



### WARNING

- Do not attempt to measure DC voltage exceeding 50V.
- Do not attempt to measure AC voltages; this could result in personal injury or damage to the unit.
- To avoid personal injury and/or damage to the unit, do not attempt to measure the voltage of a generator. This will result in an AC voltage being applied to the voltage generating output terminals.
- After measuring a high voltage battery, and before continuing to measure a low voltage battery, short the measurement leads by touching the lead tips together. This will discharge the DC-elimination capacitor (connected across the leads); otherwise a dangerous condition can exist where an excessive voltage may be applied to the low voltage battery.

### Test Leads

Two sets of test leads are supplied with the meter. Both sets provide four (4) terminal Kelvin connections which eliminate lead resistance and probe contact resistance. The application will dictate whether the alligator type or the press-probe type should be used.

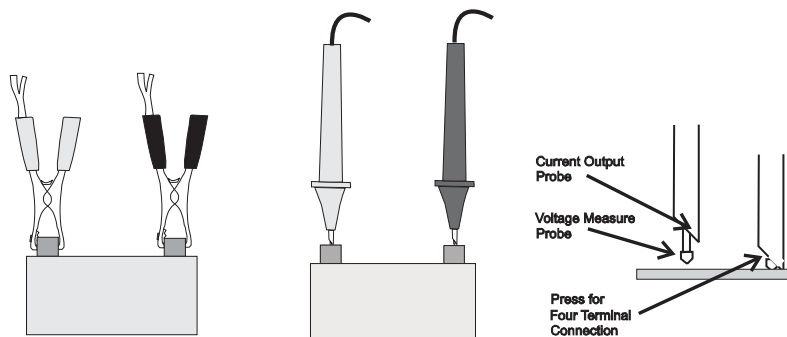

### Testing Procedure

Connect the red test lead to the "+" jack and the black test lead to the "-" jack.

1. Press the Power  button to switch the tester ON.
2. Use the V-RANGE or  $\Omega$ -RANGE buttons to select the desired Voltage or Resistance range.
3. Perform a REL Zero adjustment (see next section) each time the range is changed.
4. Connect the red test probe to the positive battery terminal, and the black test probe to the negative battery terminal.
5. Read the battery's internal resistance and the DC voltage directly on the meter's display.

Note: When the measured DC voltage or battery internal resistance value is over range, "OL" is displayed. When the AC test current faults "- - -" will be displayed.

### REL Adjust (ZERO)

The **REL** function zeros the selected range. The reading displayed when the REL button is pressed will be taken as zero and will be used to 'offset' subsequent measurements.

1. Short the four (4) probe tips of the red and black test leads as shown in the accompanying diagrams.
2. Press the REL button and the display will show the 'R' icon and the resistance and voltage values will zero.
3. Connect the test leads to the battery to be tested.
4. The REL zero adjust must be performed each time the range of the meter is changed, the test leads are swapped, or after switching between resistance and voltage tests.

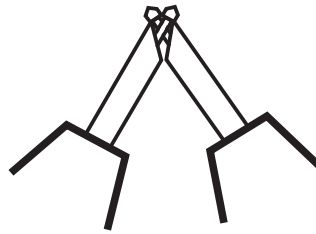
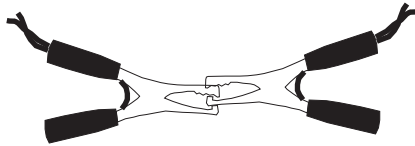

## Comparator (99 sets)

The comparator function compares the measured values with preset High and Low limit values for internal resistance and threshold voltage level, and determines the range that the measurement should fall into. Then, according to the following conditions, switches ON the corresponding LED, and sounds an audible alert as shown in the table below for the WARNING and FAIL conditions.

### Comparator Settings

1. Press and hold the **SET** button for 3 seconds then release, the display will show **COMP.SET** indicating the comparator mode is enabled.
2. Use the **▲** or **▼** button to change the comparator number from 01 up to 99.
3. Use the **V-RANGE** or **Ω-RANGE** buttons to set the desired voltage and resistance measurement range.
4. Press **▶** once, the **LOW** icon and the left two digits of the low limit resistance will be flashing. (Use the **▲** & **▼** buttons to select the desired value.)
5. Press **▶** once, the right two digits of the low limit resistance will be flashing. (Use the **▲** and **▼** buttons to select the desired value.)
6. Press **▶** once, the **HIGH** icon and the left two digits of the high limit resistance will be flashing. (Use the **▲** and **▼** buttons to select the desired value.)
7. Press **▶** once, the right two digits of the high limit resistance will be flashing. (Use the **▲** and **▼** buttons to select the desired value.)
8. Press **▶** once, the left two digits of the threshold voltage will be flashing. (Use the **▲** and **▼** buttons to select the desired value.)
9. Press **▶** once, the right two digits of the threshold voltage will be flashing. (Use the **▲** and **▼** buttons to select the desired value.)
10. Repeat step 2 to step 9 to set the next comparator number.
11. Press SET again to exit the comparator setting mode.

### Comparator Table

Resistance		Low limit resistance			High limit resistance		
		Lo	Middle	Hi	Lo	Middle	Hi
Voltage	Lo	WARNING Beeper	WARNING Beeper	FAIL Beeper			
Comparison	→						
Value	Hi	Pass	WARNING Beeper	FAIL Beeper			

### Comparator Start / Stop Controls

1. Press **SET** to activate the comparator function, the **COMP** indication will appear on the display. The comparator will operate once measurements are taken.
2. Use the **▲** and **▼** buttons to select the desired comparator number. The selected comparator number remains in memory even when the power is switched off.
3. Press **•••** to set the audible alert ON, the **•••** indication will appear on the display, and the audible tone will sound with a WARNING or FAIL result. Press **•••** again to disable the audible alert.
4. Press SET again to switch off the comparator function.

## ***Datalogging***

---

### **Manual Data Logging (999 sets)**

1. Log readings one at a time to the internal memory by pressing the **M** **MEMORY** button. "DATA M NO XXX" will appear on the LCD for one second to indicate the memory location.
2. Press **R** **READ** button to review logged readings. The display will show "DATA R NO XXX".
3. Use the **▲** and **▼** buttons to scroll the logged readings.
4. Press **R** **READ** again to discontinue viewing the logged readings.

### **Continuous Data Logging**

1. Press **HOLD** for 2 seconds, then release, and the display will show the **INTV** icon.
2. Use the **▲** or **▼** button to select the desired interval time (datalogging sample rate) from 1 second to 255 seconds.
3. Press **SET** to save and exit the interval time setting mode.
4. Press and hold **M** **MEMORY** for 2 seconds to enter the continuous (automatic) logging mode, the display will show the **M** icon.
5. The **M** will flash each time a reading is stored.
6. Press **M** **MEMORY** again to exit the continuous datalogging mode.
7. Data stored using the continuous datalogging mode cannot be read directly on the tester's display, it must be downloaded to a PC using the supplied software.

### **Clearing the Datalogger Memory**

When the internal memory is full, the **Full** icon will appear on the display and datalogging will stop.

1. Press **I** to switch OFF the tester.
2. Press and hold the **MEMORY** button, and while continuing to hold the **MEMORY** button, press the **I** button. The display will show the **CLr** icon and all datalogged readings will be cleared from memory.



## Specifications

Resistance measurement method	Four (4) terminal Kelvin connections
A/D conversion	Dual slope
Displays	Dual LCD for measurements and programming icons Three (3) test status LEDs
Datalogger Sampling rate	1 to 255 seconds (interval time between logged readings)
Open-circuit terminal voltage	3.5Vpp max
Measurement frequency	1KHz $\pm$ 10%
Input over range	"OL" display
Low battery indication	<b>BT</b> display
Test current fault detect	"- - -" display
Auto power off	After approximately 30 minutes
Zero (Relative) function	Circuit offset voltage is displayed as 0V
Hold function	Display freezes
Audible Alarm function	Audible alert for Warning and Failure conditions (can be set ON or OFF)
Comparator settings	Resistance High/Low limits and Voltage threshold point
Number of comparator configurations	99 sets
Comparator output	Test status LEDs for Pass (green), Warning (yellow), and Fail (red) results (audible tone for Warning and Fail conditions)

Resistance	Lo	IN	Hi
Voltage	Lo	IN	Hi
Lo	Warning	Warning	Fail
Hi	PASS	Warning	Fail

Manual Datalogging memory	999 sets can be stored in meter's internal memory
Continuous (automatic) Datalogging	9600 sets can be stored in meter's internal memory
Operating conditions	0° to 40°C (32 to 104°F) 80%RH (non-condensing)
Storage conditions	-10° to 50°C (14 to 122°F) 80%RH (non-condensing)
Power source	Six (6) 'AA' 1.5V batteries; Optional 9V AC adaptor
Maximum power consumption	1.0VA
Maximum continuous operation	7 hours approx.
Altitude	2000m max.
Dimensions	250 x 100 x 45mm (9.8 x 3.9 x 1.7")
Weight	500g (1.1 lbs.) approx. (including batteries)
Accessories	Test Leads and batteries
Optional equipment	AC adaptor (9V output)

### Electrical Specifications

To ensure accuracy the ambient temperature should be  $23^{\circ}\text{C} \pm 5^{\circ}$  with a humidity of 80% RH (maximum) non-condensing. In addition, perform a Zero adjustment after each range change.

#### Resistance measurements

Temperature coefficient:  $(\pm 0.1\% \text{ rdg} \pm 0.5 \text{ digits})/^{\circ}\text{C}$   
Measurement frequency:  $1\text{KHz} \pm 10\%$   
Measurement burden voltage:  $1.5\text{mVAC}$

Range	Resolution	Measurement current	Accuracy
40m $\Omega$	10 $\mu\Omega$	37.5mA approx.	$\pm(1\% \text{ reading} \pm 10 \text{ digits})$
400m $\Omega$	100 $\mu\Omega$	3.75mA approx.	
4 $\Omega$	1m $\Omega$	375 $\mu\text{A}$ approx.	
40 $\Omega$	10m $\Omega$	37.5 $\mu\text{A}$ approx.	

#### Voltage Measurements

Temperature coefficient:  $(\pm 0.1\% \text{ rdg} \pm 0.5 \text{ digits})/^{\circ}\text{C}$

Range	Resolution	Accuracy
4V	1mV	$\pm(0.1\% \text{ reading} \pm 6 \text{ digits})$
40V	10mV	

Maximum Input Voltage: 50VDC maximum

No AC voltage input permitted

Maximum voltage allowed between input terminals and ground: 60VDC/AC



**DANGER**

Do not exceed the maximum permissible input voltage (60VDC/AC) to the measurement terminals. This could result in personal injury and/or damage to the unit.

## **Maintenance**

---

### **Cleaning**

1. Repair or service not covered in this User Guide should be performed by qualified personnel only.
2. Periodically wipe the case with a dry cloth; do not use abrasives or solvents.

### **Battery Check & Replacement**

The **BT** symbol will be displayed when the batteries need replacement.

1. Disconnect the test leads from the meter and from devices under test
2. Switch OFF the power to the tester
3. Open the battery compartment cover with a screw driver
4. Replace the batteries observing polarity
5. Replace and secure the battery cover

### **Battery Safety Reminders**

- Please dispose of batteries responsibly; observe local, state, and federal regulations with regard to battery disposal at all times.
- Never dispose of batteries in a fire. Batteries may explode or leak.
- Never mix battery types. Always install new batteries of the same type.



Never dispose of used batteries or rechargeable batteries in household waste. As consumers, users are legally required to take used batteries to appropriate collection sites, the retail store where the batteries were purchased, or wherever batteries are sold.

**Disposal:** Do not dispose of this instrument in household waste. The user is obligated to take end-of-life devices to a designated collection point for the disposal of electrical and electronic equipment

## **PC Software**

---

### **Overview**

The supplied software combines **data acquisition** and **datalogger** functionality.

Refer to the Software Help document that comes with the software on how to operate the software.