

 686 Advanced Digital Pressure Gauge  
 673 Advanced Digital Pressure Calibrator



ADT686 Advanced Digital Pressure Gauge  
ADT673 Advanced Digital Pressure Calibrator  
-----User Manual  
[Version: 2506V02]

 **0035 IP67**

**Additel Corporation**

## **STATEMENT**

This user manual provides operating and safety instructions for the ADT686 Advanced Digital Pressure Gauge and ADT673 Advanced Digital Pressure Calibrator. To ensure correct operation and safety, please follow the instructions in this manual. Additel Corporation reserves the right to change the contents and other information contained in this manual without notice.



---

## CONTENT

<b>Content</b> .....	<b>1</b>
<b>Safety Instructions</b> .....	<b>1</b>
<b>1. Introduction</b> .....	<b>2</b>
1.1 Overview.....	2
1.2 Pressure Range and Accuracy .....	3
1.3 Specification.....	8
1.4 Characteristics .....	10
1.5 Basic Structure.....	11
<b>2. Display and Operation</b> .....	<b>13</b>
2.1 Main page .....	13
2.2 Control Center.....	15
2.3 Pressure Measurement Function.....	17
2.3.1 Zeroing .....	17
2.3.2 Statistics .....	18
2.3.3 Filtering.....	18
2.3.4 Unit Switch .....	19
2.3.5 Pressure Setting.....	19
2.3.6 Display Resolution Setting.....	20
2.4 Electrical Measuremnt(only for ADT673).....	21
2.4.1 Measuring Item Switch .....	22





---

2.4.2 Zeroing .....	22
2.4.3 Scaling.....	22
2.4.4 Filtering.....	22
2.4.5 Statistics .....	23
2.5 Intelligent HART Calibration(Only support ADT673).....	23
<b>3. Setting .....</b>	<b>30</b>
3.1 Communication Setting .....	32
3.1.1 Bluetooth .....	32
3.1.2 Wireless Communication .....	32
3.1.3 Serial Communication .....	32
3.1.4 ACloud Service .....	33
3.2 Personalization.....	33
3.2.1 Custom Units .....	33
3.2.2 CSV File Format .....	34
3.2.3 Date & Time.....	34
3.2.4 Sound .....	34
3.2.5 Language .....	35
3.2.6 Display Direction.....	35
3.3 System service .....	35
3.3.1 System Calibration .....	35
3.3.2 Repair and Maintenance .....	39



---

3.3.3 Restore Factory Settings .....	39
3.3.4 System Update .....	39
3.4 Power Management .....	40
3.4.1 Display Brightness .....	40
3.4.2 Battery Information .....	40
3.4.3 Auto Backlight Off .....	40
3.4.4 Auto Power Off After Backlight Off .....	40
3.4.5 Charge Mode .....	41
3.5 Product Information .....	41
<b>4. Task (ADT673 only) .....</b>	<b>42</b>
4.1 Calibrate Pressure Dial Gauge .....	42
4.2 Calibrate Pressure Transmitter .....	44
4.3 Calibrate Pressure Switch .....	47
<b>5. Data Log .....</b>	<b>50</b>
<b>6. Data Management .....</b>	<b>51</b>
<b>7. Application .....</b>	<b>52</b>
7.1 Pressure Unit Converter .....	52
7.2 Leak Test .....	52
7.3 PSV Test .....	53
<b>8. HART Communicator (ADT673 only) .....</b>	<b>55</b>
8.1 HART Connection and Search .....	55

---



---

8.2 HART Communicator Operation .....	55
<b>9. Copyright .....</b>	<b>56</b>
<b>Appendix A: Description of RS232 module DB9 pins.....</b>	<b>56</b>
<b>Appendix B: Description for Type-C to USB female OTG adapter.....</b>	<b>58</b>
<b>Appendix C: Communication commands.....</b>	<b>62</b>





---

## Safety Instructions

Warnings - The situation that poses a threat to user safety;

Cautions - The condition that may cause damage to the gauges or affect the calibration result.

### Warnings :

**To prevent personal injury, please follow this user manual.**

**To prevent possible fire, electrical shock, or personal injury, please do as follows:**

#### 1. General:

**Please confirm the pressure media before using. If no special instructions, prepare as below:**

- ◆ Before using the product, please read the manual, especially the "Safety Instructions" section;
- ◆ Before using the product, please check the appearance of the product for any damage;
- ◆ Please following the operation steps in the manual when using the product;
- ◆ Please store, carry and use the product in the correct direction.
- ◆ If the product is damaged or malfunctions, please do not use it, and contact Additel;
- ◆ Do not use this product in an explosive gas, steam or dust environment;

#### 2. Electrical:

- ◆ Double check the power connection and installation before use;

#### 3. Cautions:

**In order to avoid damaging the digital pressure gauge, please follow the user manual.**

**To prevent possible damage of the product, please:**

- ◆ Do not use the product under strong mechanical vibration environment;
- ◆ Do not use the product if it appears to have any issues, and contact Additel immediately



---

## 1. Introduction

### 1.1 Overview

ADT686 Advanced Digital Pressure Gauge/ ADT673 Advanced Digital Pressure Calibrator are the newest generation of Additel pressure calibration products. They are excellent calibration and measurement devices.. These units have pioneered the use of a circular TFT-LCD capacitive touch screen and an easy-to-use interface. ADT673 Advanced Digital Pressure Calibrator can be easily used to perform the calibration of pressure transmitters, pressure switches, precision pressure gauges, general pressure gauges, sphygmomanometers, pressure sensors, etc., and can also be used for precision pressure measuring.

The ADT686 Advanced Digital Pressure Gauge/ ADT673 Advanced Digital Pressure Calibrator are a product of accumulated experience and innovative technology to achieve excellent product performance and provide users with a variety of professional solutions, applied in the industry of power, petrochemical, metrology, metallurgy, pharmaceutical, biotechnology, food, machinery, shipbuilding, aerospace, transportation and others. These products have become the ideal solutions for field and laboratory pressure calibration.





## 1.2 Pressure Ranges and Accuracy

Table 1 Gauge pressure

P/N	Pressure Range		Media <sup>[2]</sup>	Accuracy		Burst Pressure
	(psi)	(bar)		%FS	%RD	
V15	-15	-1.0	G	0.02 (0.05)	N/A	3X
GP2	2	0.16	G,L	0.05	N/A	3X
GP5	5	0.35	G,L	0.05	0.1	3X
GP10	10	0.7	G,L <sup>[3]</sup>	0.02 (0.05)	0.1	3X
GP15	15	1.0	G,L <sup>[3]</sup>	0.02 (0.05)	0.1	3X
GP30	30	2.0	G,L <sup>[3]</sup>	0.02 (0.05)	0.1	3X
GP50	50	3.5	G,L	0.02 (0.05)	0.1	3X
GP100	100	7.0	G,L	0.02 (0.05)	0.1	3X
GP150	150	10	G,L	0.02 (0.05)	0.1	3X
GP300	300	20	G,L	0.02 (0.05)	0.1	3X
GP500	500	35	G,L	0.02 (0.05)	0.1	3X
GP600	600	40	G,L	0.02 (0.05)	0.1	3X
GP1K	1,000	70	G,L	0.02 (0.05)	0.1	3X
GP1.5K	1,500	100	G,L	0.02 (0.05)	0.1	3X





GP2K	2,000	140	G,L	0.02 (0.05)	0.1	3X
GP3K	3,000	200	G,L	0.02 (0.05)	0.1	3X
GP5K	5,000	350	G,L	0.02 (0.05)	0.1	3X
GP10K	10,000	700	G,L	0.02 (0.05)	0.1	3X
GP15K	15,000	1,000	G,L	0.05 (0.1)	0.1	1.5X
GP20K	20,000	1,400	G,L	0.05 (0.1)	N/A	1.5X
GP25K	25,000	1,600	G,L	0.05 (0.1)	N/A	1.5X
GP30K	30,000	2,000	G,L	0.05 (0.1)	N/A	1.5X
GP36K	36,000	2,500	G,L	0.05 (0.1)	N/A	1.5X
GP40K	40,000	2,800	G,L	0.05 (0.1)	N/A	1.35X
GP50K	50,000	3,500	G,L	0.1 (0.2)	N/A	1.2X
GP60K	60,000	4,200	G,L	0.1 (0.2)	N/A	11X

[1] Sealed gauge pressure for above 1,000 psi

[2] G=Gas, L=Liquid

[3] 0.02% FS for gas media only



Table 2 Differential pressure

P/N	Pressure Range		Media	Accuracy (%FS) <sup>[1]</sup>	Burst Pressure	Static Pressure Range
	(inH <sub>2</sub> O)	(mbar)				
DP1	±1	±2.5	G	0.05 <sup>[2]</sup>	100X	±10 psi
DP2	±2	±5.0	G	0.05 <sup>[2]</sup>	100X	±10 psi
DP5	±5	±10	G	0.05 <sup>[2]</sup>	50X	±10 psi
DP10	±10	±25	G	0.05 <sup>[2]</sup>	20X	±10 psi
DP20	±20	±50	G	0.05	20X	±10 psi
DP30	±30	±75	G	0.05	20X	±10 psi
DP50	±50	±125	G	0.05	3X	±10 psi
DP100	±100	±250	G	0.02	3X	±15 psi
DP150	±150	±350	G	0.02	3X	50 psi
DP300	±300	±700	G	0.02	3X	50 psi

[1] FS specification applies to the span of the range. Accuracy includes one year stability.

[2] 0.05%FS accuracy (incl 6 months stability). One year accuracy is 0.05%FS calibration accuracy combined with 0.05%FS one year stability.





Table 3 Compound pressure

P/N	Pressure Range		Media <sup>[1]</sup>	Accuracy		Burst Pressure
	(psi)	(bar)		%FS <sup>[2]</sup>	%RD	
CP2	±2	±0.16	G	0.05	N/A	3X
CP5	±5	±0.35	G	0.02 (0.05)	0.1	3X
CP10	±10	±0.7	G	0.02 (0.05)	0.1	3X
CP15	±15	±1	G	0.02 (0.05)	0.1	3X
CP30	-15 to 30	-1 to 2	G	0.02 (0.05)	0.1	3X
CP100	-15 to 100	-1 to 7	G,L	0.02 (0.05)	0.1	3X
CP300	-15 to 300	-1 to 20	G,L	0.02 (0.05)	0.1	3X
CP500	-15 to 500	-1 to 35	G,L	0.02 (0.05)	0.1	3X
CP600	-15 to 600	-1 to 40	G,L	0.02 (0.05)	0.1	3X
CP1K	-15 to 1000	-1 to 70	G,L	0.02 (0.05)	0.1	3X

[1] G=Gas, L=Liquid

[2] FS specification applies to the span of the range.



Table 4 Absolute pressure

P/N	Pressure Range		Media <sup>[1]</sup>	Accuracy (%FS)	Burst Pressure
	(psi)	(bar)			
AP5	5	0.35	G,L	0.1	3X
AP10	10	0.7	G,L	0.1	3X
AP15	15	1.0	G,L	0.1	3X
AP30	30	2.0	G,L	0.1	3X
AP50	50	3.5	G,L	0.1	3X
AP100	100	7.0	G,L	0.05(0.1)	3X
AP300	300	20	G,L	0.05(0.1)	3X
AP500	500	35	G,L	0.05(0.1)	3X
AP1K	1000	70	G,L	0.05(0.1)	3X
AP3K	3000	200	G,L	0.05(0.1)	3X
AP5K	5000	350	G,L	0.05(0.1)	3X

[1] G=Gas, L=Liquid

\*Note

- ◆ Temperature Compensation:(-10~50)°C, 1year accuracy;
- ◆ Abs pressure, 0.05% accuracy, the time to guarantee this accuracy is 180days;
- ◆ The medium requires non-corrosive;



### 1.3 Technical Specifications

Table 5 Technical Specifications

Protection level	IP67
Pressure units	Pa, hPa,kPa, MPa, psi, bar, mbar, torr, gf/cm2, kgf/cm2, inH2O@4°C , inH2O@20°C , mmH2O@4°C , mmH2O@20°C , ftH2O@4°C , ftH2O@4°C ,inHg@0°C , mmHg@0°C ,mtorr, lb/ft2,tsi,psf, inH2O@68F, ftH2O@68F, Different pressure ranges have different units. Users can custom 5 pressure units.
Pressure overload	When the pressure measurement value exceeds 120% FS, the outer circle of the screen will turn red, and flash and the speaker sounds an alarm rhythmically
Measurement speed	User can set the measure speed, default 3 times/second
Display digit	User can set it to 4, 5 and 6, default is 5
Working environment	Ambient temperature: (-10~50)°C Relative humidity: <95% non-condense Atmospheric pressure: (86~106)kPa
Warm up time	15 Mins
Barometric measure	Range:(60~110)kPa.a, Accuracy: ±55Pa
Communication	BLE(built-in), USB(master and slave), WIFI(optional), RS232(optional)
Real-time clock	Switchable between 24/12 hours and set time zones
Storage capacity	8 GB







Display	Circular TFT LCD capacitive touch screen
Power supply	1. 6600mAh Lithium-ion rechargeable battery, power consumption around 2.5W 2. Special TYPE-C USB adapter for power supply, maximum charging current 2A (battery power for best accuracy);
Charging	Charging time is about 5 hours, provided by dedicated 5V adapter
Battery life	24V power supply loading will affect the battery life.
Dimension	175mm×118mm×41mm
Weight	715g
Electrical Connections	Circuit, voltage and switches: standard $\phi$ 4mm; DC24Voutput: standard $\phi$ 4mm; Charging: standard TYPE-C USB connection

Table 6 Electrical Specification (only for ADT673)

Current Measurement	$\pm$ 30.0000mA; Accuracy: $\pm$ (0.01%RD+0.005%FS); Resolution:0.0001mA; Input impedance: 25 $\Omega$ .
Voltage Measurement	$\pm$ 30.0000V; Accuracy: $\pm$ (0.01%RD+0.005%FS); Resolution:0.0001V; Input impedance <1M $\Omega$ .
Switch Test	Mechanical, NPN and PNP type supported.
Output	Internal loop power: 24V $\pm$ 1V, maximum output circuit: 30mA.
	The internal 250 $\Omega$ HART resistance is switchable, three types of HART transmitter connections are





Loop Transmitter Measurement	supported: 1) offline calibration mode: internal power supply, internal resistance; 2) communicator: external power supply, external resistance; 3) online calibration mode: external power supply, internal resistance;
------------------------------	---

#### 1.4 Features

High accuracy pressure measurement, wide range temperature compensation;

mA, Voltage and switch measurements; (Only for ADT673)

DC24V power supply, no external power supply is needed to verify the transmitter; (Only for ADT673)

Based on SDC625 full-function HART, HART pressure transmitter can be easily calibrated;

Built-in atmospheric pressure module, providing accurate reference of ambient pressure, convenient for gauge/absolute pressure synthesis;

4, 5, 6 digits display user selectable resolution;

Analog dial indication, which greatly facilitates dial gauges' calibration;

8 GB large capacity storage;

The powerful UI function, the pioneering use of a circular TFT LCD capacitive touch screen for real-time display, and supports USB, Bluetooth, WIFI or RS232 communication;

Smart ACloud service, you can connect remotely through mobile phone or PC, not limited by space distance (only when equipped with WIFI module);

Large capacity removable rechargeable lithium-ion battery.



---

1.5 Basic Structure

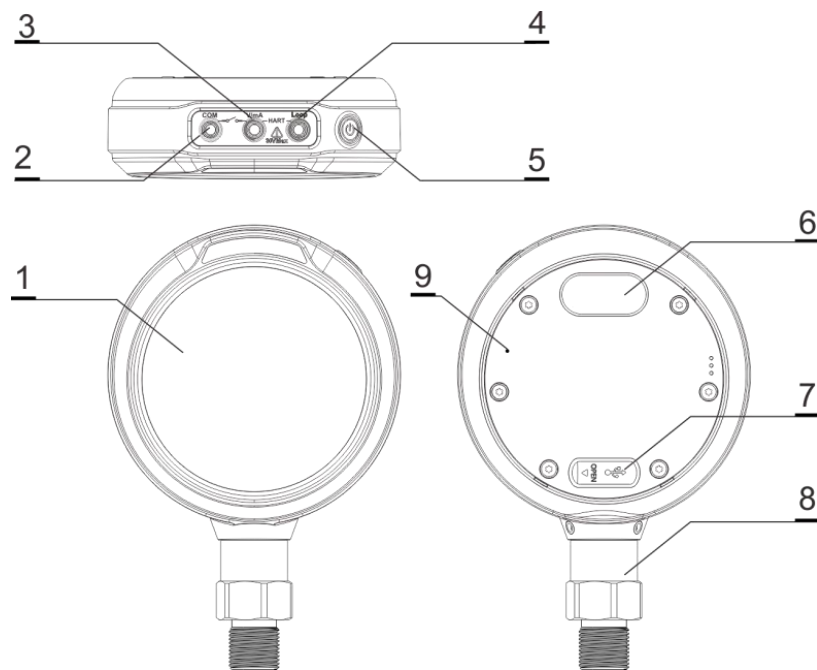

Figure 1 Basic Structure



Table 7 Main connections

No.	Introduction	Comment
1	LCD	
2	COM	ADT673 only, common, black
3	V/mA/SW	ADT673 only, voltage/circuit/switch measurement input, red and white
4	Loop	ADT673 only, DC power output, red
5	Power	Short press to turn on, press and hold for 2 seconds to turn off, short press to take a screenshot when it is turned on.
6	External module	If needed, RS232 module and WIFI module are available
7	USB TYPE-C	Communication or power supply
8	Pressure module	
9	Pressure inlet	Visible only after removing the back cover(with ATM mark), it is used for air connection of the barometric calibration



---

## 2 Display and Operation

### 2.1 Main Page

There are three modes provided in main page: calibrator mode (only for ADT673), digital gauge mode and dial gauge mode, see the Figure 2.



Figure 2 Three modes in main page

Calibrator mode: upper is electrical channel, lower is pressure measurement channel, click each to enter the function menu of the corresponding channel (only ADT673 supports this mode).

Digital gauge mode: exclusive pressure measurement channel, for better observe the pressure unit change, when you click it, you can enter the function menu of the pressure channel for function settings.



---

Dial gauge mode: The pressure value is displayed in the form of a dial pressure gauge, which is a more intuitive way to display the pressure value and changes.

Each page is divided into three parts: status bar, content area, toolbar and pressure percentage indication.



- (1) Status bar: including time and date, Bluetooth, WIFI, USB status, ACloud service, battery status, adapter status, 24V status;
  - ① Click the status bar to enter the control center to quickly view and control more function items, click the battery icon to enter the status bar in the dial gauge mode;
  - ② The adapter status has three indication icons: power only, slow charge (high-precision charging mode) and fast charge.
- (2) Content area: including calibration value display, statistical value display, and function item open icon display;
- (3) Menu bar at the bottom: Click the menu bar at the bottom of the main page to enter the function menu, so that you can enter the system settings and various applications.
- (4) Pressure percentage indication: The real-time pressure and the percentage of the pressure module range are displayed on the outermost circle of the page. In order to ensure the safety of the product, the pressure value is the value before tare calculation (if the pressure tare function is enabled).

## 2.2 Control Center

Click on the status bar at the top of the interface to pop up the control center interface, as shown in Figure 3. The control center provides quick viewing of various commonly used information and shortcut operations



Figure 3 Control Center

-  : Time and date icon, showing the system date and time, click to modify the time and date ;
-  : Battery icon, showing the remaining battery power, click to modify the charging mode when plugging the adaptor ;
-  : Atmospheric pressure icon, showing the current atmospheric pressure value, click to modify the atmospheric pressure unit ;



: Internal temperature icon, which displays the ambient temperature in the device, click to modify the temperature unit. This function is used for compensation temperature and not process temperature.



: Notification center icon, when there is an abnormal message notification, there will be a red dot on the icon to remind you, click to enter the notification center, and the received abnormal notification information will be displayed ;



: Bluetooth icon, display the status of Bluetooth, click to turn off/off Bluetooth ;



: 24V power supply icon, display the 24V power supply status, click to turn on/off the 24V power supply(ADT673 only)



: Snapshot icon, click to take a screenshot of the current screen ;



: Screen lock icon. After clicking the lock screen operation, it will enter the lock screen state. The rest of the screen is unavailable except for the unlock key. You need to click the unlock icon at the top of the screen to unlock ;



---

### 2.3 Pressure Measurement Function

Click on the pressure channel function area, and you can perform basic configuration of the pressure channel at this time, such as zeroing, filtering, and statistical functions. The interface display is shown in Figure 4.



Figure 4 Pressure Measurement Function

#### 2.3.1 Zeroing

Zeroing: In gauge pressure mode, when the gauge is vented to the atmosphere, it provides a zeroing operation when the zero point is deviated to eliminate the measured zero-point drift. The allowable zeroing range is within 1% FS.



### 2.3.2 Statistics



Click  to open statistics function to view statistics and reset statistics.

Table 8 Statistics

Item	Description
Enabled	Open statistics function
Max	Max value
Min	Min value
Avg	Average value
	Reset statistics

### 2.3.3 Filtering

Filtering: Provides first-order linear filtering and moving average filtering, and moving average filtering also provides settings for de-extreme value pairs

Table 9 Filtering

Item	Effective value	Description
Enabled	Open/Close	Open filtering function
Filtering types	Average value filtering/first-order linear filtering	The filtering method
Coefficient	0.01~1	Only for first-order linear filtering
Filtering sampling number	1~100	Sampling number of average

		filtering
Number of de-extreme value pairs	0~10	Number of average filtering de-extreme pairs

### 2.3.4 Unit Switch

Click  to enter the pressure unit selection interface (as shown in Figure 5), you can choose the unit to change.



Figure 5 Unit switch

### 2.3.5 Pressure Setting

Click  to enter the pressure setting interface to perform operations such as pressure type, readings number, stability enable, alarm, and tare function for pressure measurement.



Table 10 Pressure Settings

Item	Effective value	Description
Pressure type	Gauge pressure/Absolute pressure	Set pressure type
Display Rate	1 ~ 10	Readings per second
Stability enabled	Open/ close	Turn on stability judgment
Stability	$\pm(0.005\sim 1)\%F.S$	It can be set after turning on stability enabled
Stability time	(1 ~ 60)S	Time to determine the stability
Tare enabled	Open/ close	Turn on the tare function
Tare value	(-999999~ 999999)	Tared value
Alarm enabled	Open/ close	Enable or disable the Alarm function. After enabling alarm function, the outer circle of the screen will indicate the range of the alarm
Alarm range	Alarm lower limit ~ Alarm upper limit	Edit the upper and lower limits of the alarm range

### 2.3.6 Display Resolution

Provides pressure measurement resolution display settings, 4, 5 and 6 digits can be set.



---

## 2.4 Electrical Measurement (ADT673 only)

Like pressure measurement, click the main value of the electrical measurement channel to enter the electrical measurement function setting interface, as shown in Figure 6.



Figure 6 Electrical signal measurement function

- ◆ It is forbidden to apply current/voltage exceeding the current measuring range to the calibrator;
- ◆ It can be zeroed by short circuit;
- ◆ If the measured value exceeds the current range, display will turn red with alarm at the same time;
- ◆ If the measured value exceeds the measurable range of the calibrator, it will display red "-----" and alarm at the same time.



### 2.4.1 Measuring a Switch



Four buttons can switch between current measurement, voltage measurement, switch test and HART communication. Switch test can choose switch type (mechanical switch, PNP and NPN electronic switch). When selecting the switch function, the latest switch type will be displayed.

### 2.4.2 Zeroing

The current/voltage signal provides short-circuit zeroing operation to eliminate the measured zero drift. The allowable zeroing range is 1%FS.

### 2.4.3 Scaling

Provides the function of converting current/voltage signals into pressure or other signals. Click  to enter proportion scaling function setting, settings seeing Table 11.

Table 11 Proportional scaling

Item	Effective value	Description
Scaling	Open/ close	Set scaling enabled
Transfer function	Linear/square root	transfer function of scaling
Input range	Channel range or less than channel range	Input range of scaling
Output range	(-999999~+999999)	Output range of scaling
Decimal digits	0 ~ 5	Scaling resolution

### 2.4.4 Filtering

For specific operations, see 2.3.3.

---

### 2.4.5 Statistics



For specific operations, see 2.3.2.

### 2.5 Intelligent HART Calibration (ADT673 only)

The calibrator supports HART communication, uses a simplified DD file to provide the setting, maintenance and calibration of common parameters for HART pressure transmitters. It is recommended to refer to the instruction manual of the transmitter before using the calibrator to operate the transmitter. If you need full-featured HART operation, please refer to Chapter 8 "HART Communicator".

Note: The calibrator always acts as the master station during the communication with the HART device. Therefore, in order to avoid harm to the control system, the HART device must be separated from the control system before using the calibrator to connect to the HART device.

#### 1. Search and Connection

- ◆ Turn on the electrical signal measurement area display in the main operation interface, select  mode to start the HART function, and the calibrator will automatically switch to the power supply configuration selected by the last HART measurement (the default connection mode uses internal resistance with internal power supply), and to search the "0" Address. After searching for the HART device, it will automatically connect and display its value.
- ◆ Press  to start search, or click the HART measurement channel screen when the HART device is not connected to enter the HART power supply configuration interface. The connection method provided by the calibrator is as follows:

1) The connection method of internal power supply and internal resistance is shown in Figure 7;



Figure 7 HART-Internal power and internal resistance

2) The connection method of external power supply and internal resistance is shown in Figure 8;

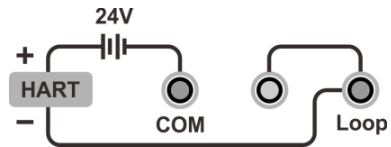

Figure 8 HART-External power and internal resistance

3) The connection method of external power supply and external resistance is shown in Figure 9;

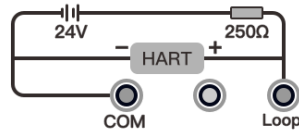

Figure 9 HART-External power and external resistance



If loop current measurement is required, please select “External power and external resistance” on calibrator and refer to Figure 10 for the actual connection.

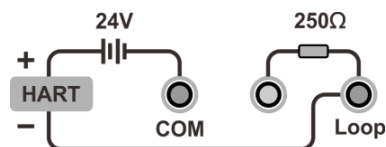



Figure 10 HART-External power and external resistance (with loop current measurement)

- ◆ After selecting the power supply configuration, enter the search interface. Start searching for HART devices from address "0", if the search is successful at address "0", stop searching and display the HART device list and main information, otherwise the calibrator will start searching from address "1" until address "15". After finishing searching, the calibrator will list all the searched HART devices, and it can support up to 15 HART devices at the same time;
  - ◆ Press  to stop searching and return back to power supply setting interface during search process;
  - ◆ Press  to re-search after finishing searching;
  - ◆ After searching, if there is HART online, choose to establish a connection with the device.
2. Online and Offline
- ◆ After the connection is established, HART will be displayed on the main operation page as an electrical test item;
  - ◆ In the main operation page, switch the electrical measurement option to other measurement modes (such as current measurement) to exit the HART connection, and at the same time, switch the HART measurement icon



in the status bar to the corresponding icon (such as current measurement);

- ◆ When the HART communication fails in the main operation page, it will automatically search for new devices again;
- ◆ In a test involving HART, if HART is offline, the test prompts HART is offline.

### 3. Process Value

- ◆ In main operation page, Hart as electrical item, press  to enter the process value, the main variable PV, output current AO, percentage, second variable, third variable and loop current can be displayed at the same time. The units of the second and third variables are determined by different device;
- ◆ In the process value menu, click them to switch the primary and secondary display;
- ◆ When do a calibration task for a HART transmitter, select the HART process value to be calibrated.

### 4. Settings

#### (1) Parameters

- ◆ In main operation page, switching into HART, then press  to enter the HART parameters setting interface, seeing Table 12.

Table 12 HART Parameters

Item	Parameters	Description and effective value
Device information	Label	Support letters, numbers, symbols input, the length cannot be greater than 8 characters
	Date	Any date supported by the transmitter can be changed
	Infor.	Support the input of letters, numbers, and symbols, and the length cannot be greater than 32 characters



	Description	Support letters, numbers, symbols input, the length cannot be greater than 16 characters
	Final assembly No.	Support integer input, the length cannot be greater than 8 digits
	Leading character number	Support integer input, the range is 5~20
	Manufacturer	Read only parameter
	Device type	Read only parameter
	Device No.	Read only parameter
	Writing protection	Read only parameter
	Universal version	Read only parameter
	Software version	Read only parameter
	Hardware version	Read only parameter
	Device version	Read only parameter
Sensor	Sensor SN	Read only parameter
	Sensor unit	Read only parameter
	Sensor lower limit	Read only parameter
	Sensor upper limit	Read only parameter
	Sensor minimum range	Read only parameter



Device output	Primary variable/range unit	It can be changed to any unit supported by the transmitter, and the upper and lower limits will be displayed along with the conversion during modification.
	PV range lower limit	Cannot exceed the lower limit of the sensor
	PV range upper limit	Cannot exceed the upper limit of the sensor
	Conversion function	Can be modified to linear or square root
	Damping	Device data filtering time, the unit is S
	Polling address	The default is 0, supports integer input, and the range is 0~15
	Burst mode	It can be set to enable/disable, depending on whether the transmitter supports it.
	Burst command	Burst command value can be set
	Alarm status	Read-only parameter

(2) Operation

- ◆ In the HART settings interface, you can view the HART parameter values in real time
- ◆ After inputting the setting status of the current option, click  to save, click  to cancel saving and return;
- ◆ If the input value is displayed in red when saving, it means the input value is not accepted, please check its input range;
- ◆ If the current setting is canceled or the setting fails, the current item is restored.

5. Service

(1) Current loop test

- ◆ Click to select diagnosis/service, enter the current loop test, and perform the current loop test. The value range of this parameter is (4-20) mA;

- 
- ◆ The HART measurement value at the top of the calibrator interface is the actual value of the current loop.

(2) PV zeroing

- ◆ Select zeroing in the HART diagnosis/maintenance interface, and enter the zeroing interface;
- ◆ Ensure that the current measurement value is close enough to the zero point, otherwise it may cause zeroing failure.

(3) Current adjustment

- ◆ By adjusting the proportional coefficient of the current output link of the transmitter, the AO value of the transmitter is consistent with the actual output loop current;
- ◆ Provides adjustment of D/A zero point (4mA) and D/A gain (20mA): you can press the screen to get the current value for adjustment

(4) Sensor trim

Sensor trim is the adjustment of the PV process variable of the transmitter, which usually contains one or two adjustment points (low point and high point). Some transmitters do not support sensor trim operations (whether the transmitter supports sensor trim, please refer to the transmitter's manual).

- ◆ Lower limit adjustment

Support setting PV unit and adjustment point value ;

Note: pressure module needs to be connected.

- 1) Manually control the pressure of the transmitter through an external source. After the pressure measurement is stable, press the Acquire key to directly obtain the standard value or directly press the number key to manually input the value to be adjusted;

Note: Some transmitters do not need to input the adjustment value, the transmitter automatically uses the upper and lower limits of the range (the lower limit of the range corresponds to the low point adjustment value,



---

and the upper limit of the range corresponds to the high point adjustment value) as the adjustment value. In this case, any value can be input ;

2) Execute the trim (Trim) command. After successful, the PV value will change according to the executed trim point value.

◆ Upper limit adjustment

The operation process is the same as that of lower limit adjustment.

◆ Restore factory

After selecting "Restore Factory", a prompt will appear asking "Are you sure to restore the sensor factory calibration?" click  on the screen to execute the factory restore command. After success, the transmitter's high and low point adjustment values will be restored to the factory adjustment state.

### 3. Setting

Enter the function menu interface by clicking the menu bar at the bottom of the main interface, select the system setting button in the function menu interface, and click  to enter the system setting interface, as shown in Figure 11. This interface includes "communication settings", "personalization", "system service", "battery information", and "product information".



Figure11 System setting interface

### 3.1 Communication Setting

#### 3.1.1 Bluetooth

The calibrator communicates with the mobile phone App via Bluetooth.

Table 13 Bluetooth communication setting

Item	Effective value	Description
Bluetooth state	Open/close	Open or close Bluetooth function
Bluetooth name	Support letters, numbers or symbols	Set the Bluetooth name of the calibrator
Physical address	Read only	

#### 3.1.2 Wireless Communication

This setting is only provided when optional module is a WIFI module, at this time the device can be connected to the wireless network through the WIFI module.

Table 14 Wireless communication setting

Item	Effective value	Description
WLAN	Open/close	Open or close Wi-Fi
Wireless network	Depends on the network environment	Wireless network access point selection
Advanced options	DHCP/manually	Choose how to get device address

◆ The port number and physical address are factory settings and cannot be changed

1. When DHCP is selected for advanced options, the contents of the following table are automatically allocated by the system and become read-only items;
2. When the manual mode is selected for the advanced options, the contents of the following table must be filled in



manually:

Table 15 Wireless communication manually setting

Item	Effective value	Description
IP Address	0.0.0.0 ~ 255.255.255.255	Set IP address of device
Subnet mask	0.0.0.0 ~ 255.255.255.255	Set subnet mask of device
Gateway	0.0.0.0 ~ 255.255.255.255	Set gateway of device

(1) Click  the button at the bottom right corner of the screen to confirm the settings.

(2) The wireless communication settings take effect directly without confirming the operation. Click  button in the upper right corner of the screen to return to the previous menu.

### 3.1.3 Serial Communication

This setting is provided when the optional module is an RS232 module, and the device can communicate through the serial port at this time.

Table 16 Serial port communication

Item	Effective value	Description
Baud rate	2400/4800/9600/19200/38400/57600/115200/256000	Factory default is 9600
Date length	7/8	Factory default is 8
Stop bit	1/2	Factory default is 1
Odd-Even check	None/Odd/Even	Factory default is None



---

### 3.1.4 Acloud Service

This setting is only provided when the optional module is a WIFI module, and the device can access ACloud cloud service through Wi-Fi wireless communication. Through the Additel Link APP, users can monitor the real-time operating status and data of the equipment anytime and anywhere, remotely control the equipment, and improve work efficiency.

#### 1. Open

When the service is not enabled, the cloud service status is empty; when the service is enabled, the cloud service is working normally, and the cloud service status icon is ; when the service is enabled but the cloud service is not successfully connected, the status icon is .

#### 2. Additel Link

Additel Link is used to display the basic information of the organization and user monitoring the current device, including the name of the organization, the username that has the authority to monitor the device, the registered email address and whether it is currently being monitored. means that the user is monitoring the current device, and means that it is not in the monitoring state.

The button on the right side of the page returns to the upper page. The button is used to cancel the binding relationship between the organization and the device, to manually refresh the organization and user information, to display the QR code, and to bind the organization (after the APP scans the QR code, the QR code will disappear automatically, or you can manually click the QR code to close it. When scanning the code to bind the relationship, you need to open the QR code).

## 3.2 Personalization

### 3.2.1 Custom Units

The device provides five custom units to be edited. The unit being used cannot be edited.

---

### 3.2.2 CSV File Format

It can be set to "." or ",".

### 3.2.3 Date & Time

Table 17 Date & time

Subject	Valid Value	Comment
Time	00:00 ~ 23:59	Time setting
Date	2020-1-1 ~ 2099-12-31	Date setting
Date format	Y-M-D / M-D-Y / D-M-Y	Date format setting
Separator	-, /, .	Date separator setting
24 hours	enable	24-hour or 12-hour format
Time zone	UTC±00:00~12:00	Set device time zone

### 3.2.4 Sound

Table 18 Personalization

Subject	Valid Value	Comment
Touch Sound	On / Off	
Prompt Sound	On / Off	
Over range Sound	On / Off	
Over Range Sound	On / Off	
Snapshot Sound	On/Off	



### 3.2.5 Language

The device provides a multi-language user interface. Use this menu to change from the provided languages. After the language is selected, the device needs to be restarted for the changes to take effect.

### 3.2.6 Display Orientation

The direction of display is adjustable for different direction of mounting.

## 3.3 System Service





### 3.3.1 System Calibration





The device provides function of calibration. Users need to enter a password to enter the system calibration page, and the factory default password is 123456. The following information is general information of the calibration page.

#### 3.3.1.1 General Information

On the right side of electrical calibration page, there will be following icons:

Table 19 Calibration icon description

Icon	Description	Electrical calibration	Pressure module calibration	Barometric calibration
	Return	●	●	●
	Restore factory	●	●	●
	Previous point	●	●	●
	Next point	●	●	●

	Save	●	●	●
	Cancel	●	●	●
	OK	●	●	●
	Cancel zero	●	●	●
	Calibration	●	●	●

### 3.3.1.2 Pressure Calibration

#### 1. Cancel zeroing



Cancel the recorded zero data.

#### 2. Multi-point calibration

##### a. Connection

Connect the calibrator with external pressure source and reference pressure standard.

##### b. Perform calibration

- ◆ Click on  to perform calibration.
- ◆ Connect the calibrator with external pressure source.
- ◆ After the pressure is stabilized, click on  to go to next point;
- ◆ Adjust the gauge output value to the same as the setpoint being calibrated;
- ◆ If the measured value has big difference with the calibration point, there will be notice by RED;
- ◆ If the calibration point has big difference with the measured value, there will be a notice, but it does not influence taking effect.



---

◆ New calibration data takes effect immediately. The calibration date will be changed to the current system date.

c. Restore the factory calibration data

Click on  to restore the factory calibration data.

### 3.3.1.3 Barometric Calibration

The calibrator provides single point or dual point calibration to the internal barometric module. Before performing the barometric calibration, remove the back cover and connect the air line to 4mm connector, as shown in the Figure 12.

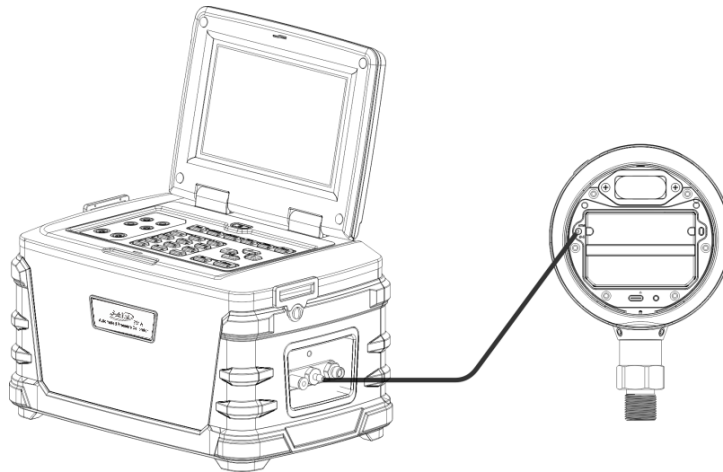

Figure 12 Barometric calibration

1. Single point calibration

Input the external barometric standard to standard pressure value, confirm and click on SAVE to finish calibration.

2. Dual point calibration

a. Connection

Connect the calibrator with external pressure source and provide greater standard of pressure.

b. Perform calibration

◆ Click on  to perform calibration.

◆ Input the external pressure according to the calibrator's notice. After the pressure is stabilized, click on  to go to next point;

◆ If the measured value has a big difference with the standard value, there will be notice by RED, the result cannot be saved now;

◆ If the calibration point has a big difference with the measured value, there will be a notice, but it does not influence taking effect.

◆ New calibration data takes effect immediately. The calibration date will be changed to the current system date.

c. Restore the factory calibration data

Click on  to restore the factory calibration data.

**3.3.1.4 Electrical Calibration (ADT673 only)**





1. Cancel zeroing

Cancel the recorded zeroing data.



---

## 2. Multi- point calibration

- ◆ Click on  to perform calibration.
- ◆ Input the standard circuit/ voltage value from standard circuit/ voltage source to the calibrator according to the calibrator's notice. After the measured value is stabilized, click  to go to the next point;
- ◆ Use  to return to upper operation at any time before the calibration is finished or use  to return to the previous point.
- ◆ If the measured value deviates a lot with the calibration point the output will be RED;
- ◆ If the calibration point deviates a lot with the measured value, there will be a notice, but it does not stop data from being taken..
- ◆ Calibration successes, new data takes effect immediately, the calibration date will be changed to the current system date.

## 3. Restore the factory calibration data

Click on  to restore the factory calibration data.

### 3.3.2 Repair and Maintenance

Enter password to start the function, default password is 123456.

Repair log: view and edit the maintenance information;

Calibration history: view calibration history.

### 3.3.3 Restore Factory Settings

The device provides the function of restoring the factory settings. A password is required to enable this function. The factory default password is 123456.

Restoring factory settings will not recover all the system calibration data. If you want to recover the system calibration data, refer to Para.3.3.1 System calibration.



---

After restoring the factory settings and restart the device, the user needs to set the time, refer to Para.3.2.3 Date and Time.

### **3.3.4 System Update**

The device provides a firmware update function. USB disk is needed; the USB disk format needs to be FAT16 or FAT32.

Operation:

1. Copy the update file to the root directory of the USB disk.
2. Insert the USB disk into the USB socket on the rear side of the exact source.
3. Select the update pack in the exact source update page.
4. Click  until the system starts to update automatically.
5. After waiting a few minutes for the update process to complete, the system will automatically show the update completion message.

## **3.4 Power management**

### **3.4.1 Display Brightness**

Change the LCD's brightness by adjusting the brightness bar.

### **3.4.2 Battery Information**

Show the current battery connection status and information.

### **3.4.3 Screen Saver**

The screen saver turns on automatically after a certain period of interface inactivity.

Select Never, 30s, 1 min, 5mins, 15mins and 30mins.

After the screen saver begins, the first press to the keypad will only activate the screen, only after this can the press takes effect.



---

#### **3.4.4 Auto Power Off**

The backlight turns off after the set time of inactivity.

It is supported to select Never, 5mins, 15mins, 30mins, 1h and 2h.

When using AC adapter, the calibrator cannot auto power off.

This function will be invalid when performing Pressure control, Auto step or Task.

The Auto power off will be invalid when the screen saver is set to Never.

#### **3.4.5 Charge Mode**

The device provides fast charge mode and high precision charge mode. The quick charge mode can improve charging speed significantly, but it has influence to the accuracy for pressure measurement. The high precision mode can ensure the accuracy for measurement but will slow down the charge speed.

The default mode is fast charge mode when device is turned on. Select high precision mode if you need to perform high accuracy pressure measurement during charging through adapter, but this will not be saved and will be reset to the quick charge mode after the device is restarted.

#### **3.5 Product Information**

Product information is read only, it includes basic information, version and running information:

Basic information: model, serial number and scale information.

Version: Host, system version, pressure module version and Wi-Fi version. The firmware version is usually referred to Host version. When contact with the customer service team, please provide information of Host version if needed.

#### 4. Task (ADT673 only)

In the function menu page, click  to enter task page. The calibrator provides test task function, which makes it possible to document calibrations, collect, store and analysis calibration data, and makes it easier to re-perform and review.

##### 4.1 Calibrate Dial Pressure Gauge

###### 1. Connection

(1) Refer to Figure 13, connect the calibrator with the dial pressure gauge;

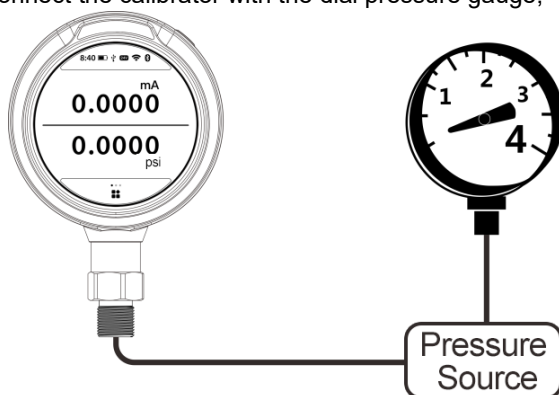

Figure 13 Calibrate Dial Pressure Gauge

(2) If the gauge is differential gauge, it is recommended to connect the REF port.

###### 2. Set a new task



Select  in the type list, input gauge information in order.





Table 20 Information of pressure dial gauge task

Subject	Valid value	Comment
Pressure type	Gauge pressure, absolute pressure	The type of calibrated gauge, view support information according to calibrator's model
Scale	Depends on the pressure gauge	The scale and unit of calibrated gauge
Accuracy	0.06%、0.1%、0.16%、0.25%、0.4%、0.6%、1%、1.6%、2.5%、4% and custom	Gauge accuracy. The value entered in custom option indicates the gauge's accuracy, for example input 1.5 for 1.5 level gauges, it means a range of (0.001~100)%

3. Task start

Click on  to start the task:

(1) Before calibrating, click on  and  to zero the pressure module;

(2) Calibration process:

1) After controlling the pressure to the first calibration point and allowing for stability, click on the top and input the gauge reading. (The calibrator can infer the gauge reading based on the standard if desired)

2) Click on  to go to next calibration point;

3) Repeat the above steps until finish the calibration. Click on  and  to stop and finish the calibration.

4. Finish task

The calibrator provides data review, sorting and storage functions for the calibration task

(1) After finishing the task, user can view the task result through the task data.

(2) User can quit the task data by clicking on  and perform the task again.



(3) Task data can be stored through , in the storage page, user can enter the following information:

Table 21 Save Task

Subject	Valid value	Comment
Name	Letters, numbers, symbols, Chinese characters	Information for calibration task name
Operator	Letters, numbers, symbols, Chinese characters	Information for task operator
Calibration date	2000/01/01~2099/12/31	Date of task performing
Ambient humidity	Numbers	Ambient humidity when performing task
Ambient temperature	Numbers	Ambient temperature when performing task
Temperature unit	K、°C、°F	Temperature unit when performing task
Save as	Before adjusting, after adjusting, or both	Save the data before or after the adjustment, or both

Note: After saving, return to the task selection page by clicking on  at the lower right side.

#### 4.2 Calibrate pressure transmitter

During performing the task, the calibrator can measure and record the current or voltage value output by the transmitter, so that the whole process can be fully automated.

1. Connection

Refer to Figure 14.

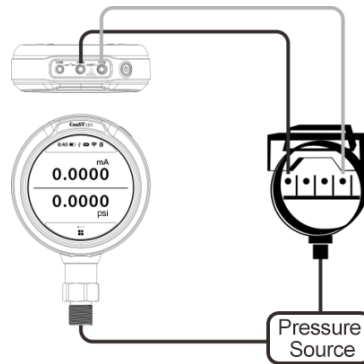

Figure 14 Calibrate pressure transmitter

2. New task



According to transmitter select (mA, V, HART), select “transmitter” icon  in the calibration list, input transmitter information:

Table 22 Information for pressure transmitter in task mode

Subject	Valid value	Comment
Pressure type	Gauge pressure, absolute pressure	The type of calibrated transmitter, view support information

		according to calibrator's model
Input	Depends on transmitter	Transmitter pressure scale
Output	Analog signal: 4~20Ma, 0~10mA, 0~20mA, 1~5V, 0~5V, 0~10V, custom	Signal output range of circuit/voltage pressure transmitter
	HART device: PV, percentage, output circuit, loop circuit	Signal output type of HART device
Transfer function	Depends on input/output relationship	Pressure transmitter transfer function
Accuracy	0.05%, 0.1%, 0.2%, 0.5%, 1%, 1.5%, 2%, 2.5%, custom	The accuracy of the pressure transmitter. The value entered in the custom option is the accuracy level of the pressure transmitter

### 3. Start the task

- (1) Operations refer to the content in Para. 4.1.
- (2) If output analog signal, it needs to set the power configuration;
- (3) If output to HART device, it needs to configure HART.
- (4) Click on  and  to zero the module;

### 4. Finish task

Operations refer to the content in Para.4.1.

### 4.3 Calibrate pressure switch

#### 1. Connection

(1) The air and circuit connection between pressure switch and calibrator are shown in Figure 15 (in the Figure it is mechanical switch).

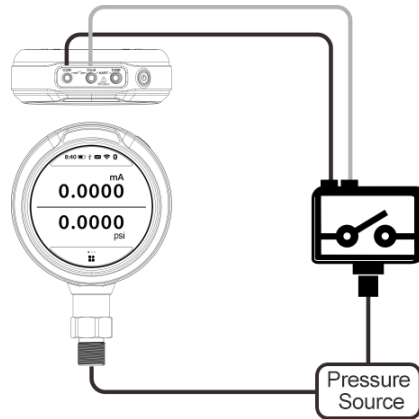

Figure15 Calibrate Pressure Switch



(2) The calibrator supports mechanical switch, NPN and PNP electronic switches. The circuit connection of mechanical switch is shown in Figure 16. The electronic switches can be connected through internal power and external power connections. Refer to Figure 17 and Figure 18.

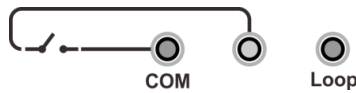

Figure 16 Mechanical switch

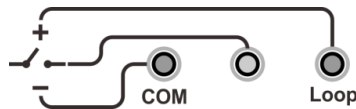

Figure 17 Electrical Switch through internal power



Figure 18 Electrical Switch through external power



---

## 2. New task



Select “Pressure switch” icon  in the calibration list, input pressure switch information in order:

Table 23 Information for pressure switch in Task mode

Subject	Valid value	Comment
Pressure type	Gauge pressure, absolute pressure	The type of calibrated switch, view support information according to calibrator's model
Scale	Depends on the switch	The switch's pressure scale
Set point	Depends on the switch's scale	Action point of the switch
Action type	NC/NO	Action type of the switch
Switch category	Mechanical, NPN, PNP switches	Category of the calibrated switch
Accuracy	0.5%, 1%, 1.5%, 2%, 2.5%, 4%, custom	Switch's accuracy. The value entered in the custom option is the accuracy level of the pressure switch

## 3. Start the task

- (1) Click on  and  to zero the module;
- (2) The bottom of the screen shows reading value of the current controlled pressure, and the top is the switch status;
- (3) Switch action status and action value will be recorded and displayed in the table;
- (4) Click on the Stop icon to close the running task and view the result;

## 4. Finish task

Refer to the content in Para.4.1.

## 5. Data log

Click on the button  in the function menu page to enter the data log management. The calibrator supports the continuous data log, which can continuously record the measured signal data within the set time. Both the electrical signal and the pressure value are recorded simultaneously.

Click on the recorded data to view it, and select  to view the curve, detailed data, export, and delete.

### 1. New test







- (1) Before recording, click on  and  to zero the pressure module;
- (2) The bottom of the screen shows reading value of the current controlled pressure, and the top is the switch status;
- (3) Switch action status and action value will be recorded and displayed in the table;
- (4) Click on the Stop icon to close the running task and view the result;
- (5) Click on  at the bottom of the screen to confirm and the task starts automatically, click on  to quit this task;
- (6) In the task, click on  to stop the record, confirm Stop by clicking on  when asking whether to stop, and the data will be saved automatically.



Table 24 Information for Data log

Subject	Valid value	Comment
Name	Letters, numbers, symbols, Chinese characters	Information for data log item name
Operator	Letters, numbers, symbols, Chinese	Information for data log operator





	characters	
Record interval	Number	Data record interval
Record point	Number	Total amount of data record points
Record date	2000/01/01~2099/12/31	Data record date
Pressure unit	Pressure unit	Type of the recorded pressure unit
Pressure type	Gauge pressure, absolute pressure	The type of calibrated switch, view support information according to calibrator's model
Electrical measurement	(-30~30)mA, (-30~30)V, switch, HART	Mode of recording the electrical measurement

2. Edit the page

When there are series of pages, switch the page number one time through , or click on Edit Page icon  to jump pages.

3. Delete mode

When you need to delete data, click on the delete mode  in the menu. Select the item to be deleted with a check icon , then delete to proceed. If you need to jump page, do the same as 2.

## 6. Data management

Click on  in the function menu to enter the data management page.

It is classified and managed by functional modes; the data saved in each function is managed in the corresponding items;

The function modes that can save data files include: snapshot, pressure leak test, etc;

Users can export data file through USB disk or PC software, the format is CSV;

Users can delete the data in batches.

## 7. Application

### 7.1 Pressure unit converter

In the function menu page, click on  to enter pressure unit converter;

The device supports convert between different pressure unit.

### 7.2 Leak test

Click on the button  in the function menu page to enter the leak test function. The leak test is to detect the degree of gas leakage by connecting the pressure gauge/calibrator to the gas circuit and performing the leak test process.

#### 1. Setting

Table 25 Information for leak test setting

Subject	Valid value	Comment
Name	Letters, numbers, symbols, Chinese characters	Item name information
Operator	Letters, numbers, symbols, Chinese characters	Operator information
Waiting time	Numbers	Pressing time of external pressure module
Running time	Numbers	Total length of recorded time
Pressure unit	Pressure unit	Type of recorded pressure unit
Pressure type	Gauge pressure, absolute pressure	The type of pressure switch, view support information according to calibrator's model



- 
- (1) Select application in the function menu and enter the leak test;
  - (2) Set the wait time
    - 1) Connect to external pressure source: the wait time will count down.
    - 2) Enter the test time after the wait time is over.
  - (3) Set test time

After entering the test time, the countdown starts and the test is carried out, the test stops when the timer reaches 0;
  - (4) Pressure type

Switch between gauge pressure/differential pressure.

    2. Carry out
  - (1) Connect air circuit
    - 1) Connect the device to the air circuit;
    - 2) Press the Start icon on the right of the screen to start the test. Apply pressure to the leak test point;
    - 3) The wait time will count down and record the real-time pressure as the initial pressure when the time is over;
    - 4) Start the test, count down the test time, and start calculating the real-time leakage at the same time, real-time leakage = initial pressure - real-time pressure;
    - 5) Record the pressure at the end of the test time as the end pressure;
    - 6) The entire leak test process finishes, and the final leakage = initial pressure - end pressure;
  - (2) The whole process will be shown in stages in the leak test curve at the bottom of the screen;

### 7.3 PSV test

Click on the button  in the function menu to enter the PSV test function. The PSV test is used to test the opening pressure of the safety valve. In order to ensure the accuracy of the opening pressure test, the pressure gauge/calibrator

will automatically enter high-speed reading mode and continuous recording of pressure data ten times per second, real-time recording of the maximum pressure, and draw the real-time pressure data curve to visually show the trend of pressure changes.

1. Setting

Table 26 information for PSV setting

Subject	Valid value	Comment
Name	Letters, numbers, symbols, characters	Information of the item name
Operator	Letters, numbers, symbols, characters	Operator information
Running time	Number	Total length of recorded time
Pressure unit	Pressure unit	Type of recorded pressure unit
Pressure type	Gauge pressure, absolute pressure	The type of pressure switch, view support information according to calibrator's model

(1) Select application in the function menu and enter the leak test;

(2) Set test time

1) After entering the test time, the countdown starts, and the test is carried out;

2) The test stops when the timer reaches 0;

(3) Pressure type

Switch between gauge pressure/differential pressure.

2. Carry out

(1) Connect air circuit

1) Connect the device to the air circuit;



- 
- 2) Press the Start icon on the right of the screen to start performing, first apply pressure to the leak test point;
  - 3) Start testing, count down the test time and record the real-time pressure point value at the same time;
  - 4) Record the maximum pressure point value during the process;
  - 5) The entire leak test process finishes, save the data;

(2) The whole process will be shown in the leak test curve at the bottom of the screen;

## 8.HART communicator (ADT673 only)

Click on the button  in the function menu page to enter the HART communicator function. The HART communicator uses the native HART DD file. The calibrator can be used to complete the maintenance and commissioning of almost all HART pressure device, including parameter modification, fault diagnosis, and daily maintenance and calibration, etc. Concerning that the operation of the communicator on the HART device depends on the DD file, the operation varies a lot between different HART devices, so please refer to the manual of the HART device before using the function.

**Note: The calibrator always acts as the master station during the communication with the HART device.**

**Therefore, in order to avoid harm to the control system, the HART device must be separated from the control system before using the calibrator to connect to the HART device.**

### 8.1 HART connection and search

Refer to Para.2.5 HART communication connection and search.

### 8.2 HART communicator operation

Read the parameters in HART and modify them, the root directory shows items1~4, depends on the HART device,



The parameters that have been modified but not written into HART are highlighted in yellow in the list, click on  to complete the writing to the HART device;



For some of the parameters, enter the page and click on  at the right of the screen to view the instruction

---



information.

Click on the  and  at the right of the screen to view the communicate status and device status respectively. Enter it and the vacant circle on the right of the list indicates that it is normal, otherwise it means that the item is abnormal.

Click on  at the right of the screen to return to the home page of the device and click on  at the right top of the screen to return to HART communicator again.

## 9. Copyright

Additel corporation owns all copyrights to this system and reserves all rights.

### Appendix A : Description of RS232 module DB9 pins

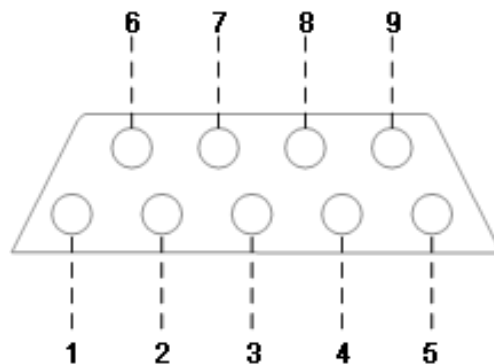

Figure 19 Description of RS232 module DB9 female pins



Table 27 Description of RS232 module DB9 pins

Pins	Description
1	Reserved
2	TXD
3	RXD
4	Reserved
5	GND
6	Reserved
7	Reserved
8	Reserved
9	Reserved



---

**Appendix B: Description for Type-C to USB female OTG adapter**



Figure 20 Type-C to USB female OTG adapter.

Type-C to USB female OTG adapter is a standard accessory, as shown in Figure 20.  
Some typical using methods of the adaptor:

---

(1) Connect to TYPE-A USB2.0 USB disk through the adapter, shown in Figure 21.

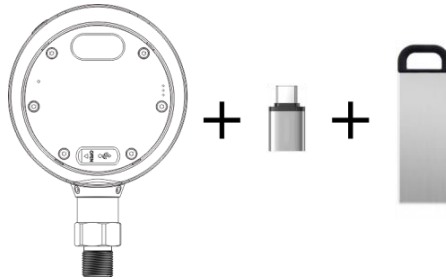

Figure 21 Connect to USB disk through the adapter

(2) Connect to PC through adapter and USB male-to-male cable, shown in Figure 22;

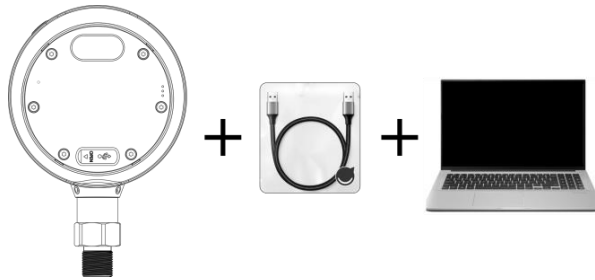

Figure 22 Connect to PC through the adapter

(3) Use the adapter to charge the device by cellphone (the cellphone must support TYPE-C OTG), as shown in Figure 23, connect the adapter to the TYPE-C port of the cellphone, and then use the TYPE-C cable to connect to the device, to charge the device by cellphone.

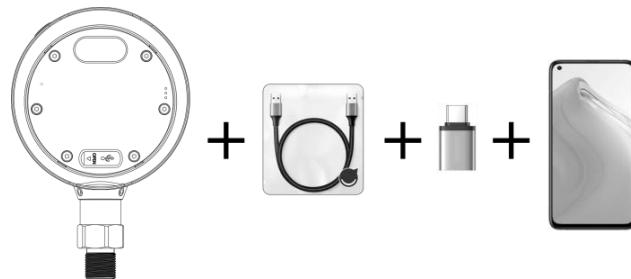

Figure 23 Connect to cellphone through the adapter

If you connect the adapter to the device, and then use the TYPE-C cable to connect to the cellphone, the device can charge the mobile phone.



---

## Appendix C: Communication commands

### 1 Commands instruction

(1) each command includes two parts: **mnemonic** and **parameter**. The **mnemonic** and **parameter** are separated by a space;

For example pressure: filter 0|1, < numeric>[,<numeric>], 0|1 refers to the parameter description specific optional option, <numeric> is the parameter to be input, [,<numeric>] refers to the additional parameter when the parameter is set to 1. if set the pressure filter function by this command, enter pressure: filter 1, 50,5

(2) about the parameter

Each parameter in the instruction set is marked with<> (do not enter angle brackets when converting to actual instructions) and separated by commas.

(3) terminator

The scpi command must include a command terminator, which can be one of the follows (excluding double quotation marks): "\r\n", "\r", "\n" or "\0".

Table 28 IEEE 488.2 common commands

No	Commands	Description	Parameter	Returned value
1	*cls	Clear the following registers: Standard event register; Query event register; Operation event register; Status byte register; Error queue.	-	-
2	*idn?	Instrument identification query, return 2 parts of data: A. Product serial number; B. Software version;	-	Product serial number, software version
3	*rst	Program reset	-	-

Table 29 Pressure commands

No	Commands	Description	Parameter	Returned value
1.	Pressure? [all]	Read current pressure value	Option all: reading barometric pressure	Pressure value, pressure unit, pressure type[,barometric pressure, barometric unit,



				barometric pressure type]
2.	Pressure:unit?	Read current pressure unit	None	Unit name
3.	Pressure:unit <numeric> <unquostr>	Set current pressure unit	Unit id or unquoted unit name	None
4.	Pressure:ptype?	Read current pressure type	None	G: gauge pressure A: absolute pressure D: differential pressure
5.	Pressure:ptype g a d	Set current pressure type	G: gauge pressure A: absolute pressure D: differential pressure	None
6.	Pressure:online?	Whether the pressure module is online?	None	0: offline 1: online
7.	Pressure:range? [<unquostr>]	Read pressure module's range	None, 0 or 1	None or 0: lower limit, upper limit, unit id, pressure type(g/a/d); 1: lower limit, upper limit, unit name, pressure type(g/a/d)
8.	Pressure:zero	Pressure module zero	None	None
9.	Pressure:resolution?	Read pressure resolution	None	4 5 6
10.	Pressure:resolution <numeric>	Set pressure resolution	4 5 6	None
11.	Pressure:filter:enable?	Read filter status	None	0: disable







				1: enable
12.	Pressure:filter:enable 0 1	Set filter type	0: disable 1: enable	None
13.	Pressure:filter?	Read filter parameter	None	Two returns format: First-order filter: 0, first-order filter coefficient Average filter: 1, de-extreme value pairs, filter window size.
14.	Pressure:filter 0 1,<numeric>[,<numeric>]	Set filter type	Two returns format: First-order filter: 0, first-order filter coefficient Average filter: 1, de-extreme value pairs, filter window size.	None
15.	Pressure:stable?	Read pressure stable status	None	0: not stable 1: stable
16.	Pressure:stable:enable?	Read the status of the stable time	None	0: disable 1: enable
17.	Pressure:stable:enable 0 1	Set the status of the stable time	0: disable 1: enable	None
18.	Pressure:stable:configure?	Read pressure stable	None	Separated by comma:



		status parameter		Stability, stable time
19.	Pressure:stable:configure <numeric>,<numeric>	Set pressure stable status parameter	Stability (0.005-1), stable time (1-60 s)	None
20.	Pressure:peak:enable?	Read pressure peak status	None	0: disable 1: enable
21.	Pressure:peak:enable 0 1	Set pressure peak status	0: disable 1: enable	None
22.	Pressure:tare:enable?	Read pressure tare function status	None	0: disable 1: enable
23.	Pressure:tare:enable 0 1	Set pressure tare function status	0: disable 1: enable	None
24.	Pressure:tare:configure?	Read pressure tare value	None	Pressure tare value
25.	Pressure:tare:configure <numeric>	Set pressure tare value	Tare value	None
26.	Pressure:clrdangp	Clear overpressure record	None	None
27.	Pressure:dangp?	Read overpressure record	None	Overpressure record
28.	Atm? [all]	Read barometric pressure value all and read process treatment value	None	Final barometric value All with the original value, linear value, tare value, filter value and final value. (with pressure type when switch pressure is

				supported)
29.	Measure?	Read the measure data	None	Type 1+ pressure value+ pressure unit id+ pressure type+ type 2+ barometric pressure+ barometric unit id+ type 3+ temperature+ temperature unit id+ type 4+ electric measurement+ electric measurement id

Table 30 Electric measure commands

No	Commands	Description	Parameter	Returned value
1.	Electricity:measure? [cal]	Read current measured value	None or cal	1. none Item no, measured value, unit name 2. cal Item no, final measured value, unit name, single-point fixed value, multi-point fixed value, linear fixed value, origin value Note: Item no: 1. current 2. voltage 3. switch 4.



				hart
2.	Electricity:function?	Read current measured item	None	Item no [item description] Item no: 1. current 2. voltage 3. switch 4. hart Switch: 0.mechanical switch 1.npn switch 2.pnp switch
3.	Electricity:function <numeric>[,<numeric>]	Set current measured item	Item no: 1. current 2. voltage 3. switch 4. hart Switch: 0.mechanical switch 1.npn switch 2.pnp switch	None
4.	Electricity:24venable?	Read 24v status	None	0: disable 1: enable
5.	Electricity:24venable 0 1	Set 24v status	0: disable 1: enable	None
6.	Electricity:zero	Electric measure zero	None	None
7.	Electricity:czero	Electric measure cancel	None	None



		zero		
8.	Electricity:switch:actions?	Read switch test act value	None	Separated by space: Act value unit name
9.	Electricity:filter:enable?	Read filter status	None	0: disable 1: enable
10.	Electricity:filter:enable 0 1	Set filter status	0: disable 1: enable	None
11.	Electricity:filter?	Read filter parameter	None	First-order filter: 0, first-order filter coefficient Average filter: 1, de-extreme value pairs, filter window size.
12.	Electricity:filter 0 1,<numeric>[,<numeric>]	Set filter parameter	First-order filter: 0, first-order filter coefficient Average filter: 1, de-extreme value pairs, filter window size.	None
13.	Electricity:scale:enable?	Read scaling status	None	0: disable 1: enable
14.	Electricity:scale:enable 0 1	Set scaling status	0: disable 1: enable	None
15.	Electricity:scale?	Read scaling configuration	None	Transfer function:0 linear 1 square





				root Input range Output range Decimal digits of output range
16.	Electricity:scale 0 1 2,<numeric>,<numeric>,<numeric>,<numeric>,<unquostr>,<numeric>	Set scaling configuration	Transfer function, input lower limit, input upper limit, output lower limit, output upper limit, output units, decimal digits of output range	None
17.	Electricity:minmax:enable?	Read min/max function status	None	0: disable 1: enable
18.	Electricity:minmax:enable 0 1	Set min/max function status	0: disable 1: enable	None

Table 31 System commands

No	Commands	Description	Parameter	Returned value
1.	System:error?	Read the execute error information	None	A message at the stack top of the error
2.	System:lock?	Read the screen lock status	None	0= unlock 1= lock
3.	System:lock 0 1 on off	Set the screen lock status	0= unlock	None



			1= lock	
4.	System:version? ["application\\" \os:firmware\ " \os:hardware\\" \wifi:firmw are\\" \bt:firmware\\" \hart:dd\ "]	Read the device version	"application" = host version, "os:firmware" system firmware version, "os:hardware" system hardware version, " wifi:firmware " wifi version " bt:firmware " Bluetooth version " hart:dd " hart dd file version	Default: No parameter= return host version With parameter= return corresponding version
5.	System:date?	Read system date	None	Date(yyyy,mm,dd)
6.	System:date <numeric>,<numeric>,<num eric>	Set system date	Year, month, day	None
7.	System:time?	Read system time	None	Time(hh,mm,ss)
8.	System:time <numeric>,<numeric>,<num eric>	Set system time	Hour, minute, second	None
9.	System:time:format?	Read system time format	None	Two values, separated by comma,





				24/12 hours Current time zone
10.	System:time:format <boolean>,<numeric>	Set system time format	Two parameters, separated by comma, 24/12 hours Current utc time zone	None
11.	System:tbeep?	Read the touch beep status	None	0 disable 1 enable
12.	System:tbeep <boolean> on off	Set the touch beep status	0 off disable 1 on enable	None
13.	System:pbeep?	Read the prompt beep status	None	0 disable 1 enable
14.	System:pbeep <boolean> on off	Set the prompt beep status	0 off disable 1 on enable	None
15.	System:orbeep?	Read the over range beep status	None	0 disable 1 enable
16.	System:orbeep <boolean> on off	Set the over range beep status	0 off disable 1 on enable	None
17.	System:stbeep?	Read the stable beep status	None	0 disable 1 enable
18.	System:stbeep <boolean> on off	Set the stable beep status	0 off disable 1 on enable	None





19.	System: shbeep?	Read the snapshot beep status	None	0 disable 1 enable
20.	System: shbeep <boolean> on off	Set the snapshot beep status	0 off disable 1 on enable	None
21.	System:volume?	Read system volume percentage	None	Volume percentage
22.	System:volume <numeric>	Set system volume	Volume percentage	None
23.	System:language?	Read current language	None	Current language
24.	System:language <unquostr>[,<boolean>]	Set current language	Parameter: language zh-cn Optional: restart or not, restart by default	None
25.	System:language:config?	Read the list of supported languages	None	Language list
26.	System:language:config <quostr>	Set the list of supported languages	Language list, separated by comma	None
27.	System:brightness? Percentage value	Read the screen brightness	Percentage or value	Screen brightness
28.	System:brightness percentage value,<numeric>	Set the screen brightness Range: Value 200-4096 Percentage 0-100	1: percentage or value 2: brightness	None



		When the set value is greater than 4096 or 100%, it will be set to the greatest brightness, when the set value is lower than 200 or 0%, it will be set to the lowest brightness.		
29.	System:battery:online?	Read the battery online status	None	1 : battery online 0 : battery offline
30.	System:battery:status?	Read the battery status	None	0: battery communication abnormal 1: battery communication ok
31.	System:battery:infomation?	Read the current battery level, voltage, current	None	Current battery level, total level (mah), voltage (v), current (>0 indicates charging, <0 indicates discharging)
32.	Display:acloud:captcha 0 1,<unquostr>,<numeric>	Show or close Acloud service verify code	1: 0-close the verify code, 1-show the verify code 2: string, verify code text 3: number, time-out time	None



33.	System:ble <boolean> on off	Bluetooth on/off	1 or on: on 0 or off: off	No return
34.	System:ble:status?	Read Bluetooth status	None	0: unknown; 1: booted; 2: initialized 3: sleep 4: broadcasting 5: connected
35.	System:ble:info? <unquostr>	Read Bluetooth information	Name: return Bluetooth version information Mac: return Bluetooth mac address Version: return Bluetooth firmware version	See the parameter

Table 32 Data management commands

No	Commands	Description	Parameter	Returned value
1.	Datamanager:count? Leaktest snapshot datalogger psvtest	Read data amount	Leaktest: leak test Snapshot: snapshot Datalogger: data log Psvtest: psv test	Data amount
2.	Datamanager:info?	Read data related	1: leaktest: leak test	Information



	Leaktest snapshot datalogger psvtest,<numeric>,<numeric>	information	Snapshot: snapshot Datalogger: data log Psvtest: psv test 2: start, start point 3: count, length	
3.	Datamanager:del leaktest snapshot datalogger psvtest,<unquostr>	Delete test result	1: leaktest: leak test Snapshot: snapshot Datalogger: data log Psvtest: psv test 2: the file path that perform the deletion (without quote mark)	None
4.	Datamanager:length? Leaktest snapshot datalogger psvtest,data image,<unquostr>	Read data length	1: leaktest: leak test Snapshot: snapshot Datalogger: data log Psvtest: psv test 2: read data file or image File name (without quote mark)	Data length
5.	Datamanager:data? Leaktest snapshot datalogger	Read data in designated location	File name (without quote mark), start point,	String format



	r psvtest,data image,<unquotedstr>,<numeric>,<numeric>		read data length	
--	--	--	------------------	--

Table 33 Calibration commands

No	Commands	Description	Parameter	Returned value
1.	Calibration:electricity:data 123456,<numeric>,<numeric>,<quotedstr>,<quotedstr>,<numeric>,<numeric>,<numeric>	Write electric calibration data	1: 0-linar 1-multi-point 2: 0-ma measure 1-30v measure Calibration point(quoted string, separated by comma) Reference point(quoted string, separated by comma) Year, month, day	None
2.	Calibration:electricity:data? 123456,<numeric>,<numeric>	Write electric calibration value	1: 0-linar 1-multi-point 2: 0-ma measure 1-30v measure	Multi-point: calibration point list, actual value list, year, month, day Single point: offset value, year, month, day
3.	Calibration:electricity:reset	Reset electric multi-point calibration data	1: 0-linar 1-multi-point	None



	123456,<numeric>,<numeric>		2: 0-ma measure 1-30v measure	
4.	Calibration:barosensor:data? 123456,<numeric>	Read barometric sensor calibration data	0-two points 1-offset 2-demarcate	With calibration data: standard value 1, measure value 1, standard value 2, measure value 2, year, month, day Without calibration data: no data!
5.	Calibration:barosensor:data 123456,<numeric>,<quoted string>,<quoted string>,<numeric>,<numeric>	Write barometric sensor calibration data	1: 0-two points 1-offset 2-demarcate 2: standard value(quoted string, separated by comma) 3: measure value(quoted string, separated by comma) Year, month, day	None
6.	Calibration:barosensor:reset 123456,<numeric>	Reset barometric sensor calibration data	0- Multi-point (reset both two-point and single-point calibration data)	None

			1- Single-point(reset both two-point and single-point calibration data)	
--	--	--	---	--

Table 34 HART

No	Commands	Description	Parameter	Returned value
1.	Hart:supplymode?	Read the power supply mode		0-ipir internal power and internal resistance; 1-eper external power and external resistance; 2-epir external power and internal resistance; 3-iper internal power and external resistance
2.	Hart:supplymode ipir eper epir iper 0 1 2 3	Set the power supply mode	0-ipir internal power and internal resistance; 1-eper external power and external resistance; 2-epir external power and internal resistance; 3-iper internal power	-



			and external resistance	
3.	Hart:search start[stop zero[,<numeric>]][, <numeric>]	Hart search;	Start: start searching; Stop: stop searching; Zero: search only zero Note: the start and stop can be added later in the address range parameter, such as“,0,15”	-
4.	Hart:devices?	Search device	-	List of devices searched (address and device type)
5.	Hart:connect<address>	Connect to searched device	Address	-
6.	Hart:onldevice:process?	Get process option	-	Pv: process variable; Ao: analog current; %: scale percentage; Sv: second variable; Tv: third variable; Fv: fourth variable; Loopcurrent: loop current
7.	Hart:onldevice:process:valu e?	Get process value	Pv: process variable; Ao: analog current;	Null: current variable Or designated value



	[pv ao sv tv fv loopcurrent]		%: scale percentage; Sv: second variable; Tv: third variable; Fv: fourth variable; Loopcurrent: loop current	
8.	Hart: ondevice: process pv ao sv tv fv loopcurrent	Switch process value	Pv: process variable; Ao: analog current; %: scale percentage; Sv: second variable; Tv: third variable; Fv: fourth variable; Loopcurrent: loop current	-
9.	Hart: ondevice: parameter? <name>	Read the parameter	Name: parameter name(quoted string)	Corresponding value
10.	Hart: ondevice: parameter<name>, <"value">	Set the parameter	Name: parameter name (quoted string) Value: value(quoted string)	-
11.	Hart: ondevice: info?	Read hart device information	None or <parameter name>	Return all parameter values of the device when there are no



			Name list: Tag Manufacturer Devicetype Deviceid Writeprotect Date Message Descriptor Finalassemble Preambles Universalrev Hardwarerev Softwarerev Devicerev	parameters; Return the corresponding parameter value for designated parameter name
12.	Hart:onlydevice:sensor?	Return all parameter values for the sensor or return the corresponding values based on the name of the designated parameters	None or <parameter name> Name list: Sn Unit Lrl Url	Return all parameter values of the sensor when there are no parameters; Return the corresponding parameter value for designated parameter name



			Minspan	
13.	Hart:onldevice:output?	Return all parameter values of hart output or return the corresponding values based on the name of the designated parameters	None or <parameter name> Name list: Unit Lrv Urv Damping Transferfunction	Return all parameter values of the hart output when there are no parameters; Return the corresponding parameter value for designated parameter name
14.	Hart:onldevice:connected?	Get the hart device connect condition	None	1 value 1=connected, 0=unconnected

Table 35 scpi unit id list

Unit id	Unit
2000	Text unit
32767	Blank unit
1211	Ma
1212	Ma
1209	A
1240	V





1241	Mv
1281	$\Omega$
1284	K $\omega$
1283	M $\omega$
1000	K
1001	$^{\circ}\text{C}$
1002	$^{\circ}\text{F}$
1003	$^{\circ}\text{r}$
999	$^{\circ}\text{re}$
1005	$^{\circ}$
1342	%
1133	Kpa
1130	Pa
1131	Gpa
1132	Mpa
1134	Mpa
1135	Mpa
1136	Hpa





---

1137	Bar
1138	Mbar
1139	Torr
1140	Atm
1141	Psi
1142	Psia
1143	Psig
1144	Gf/cm <sup>2</sup>
1145	Kgf/cm <sup>2</sup>
1147	Inh2o@4°c
1148	Inh2o@68°f
1150	Mmh2o@4°c
1151	Mmh2o@20°c
1153	Fth2o@4°c
1154	Fth2o@68°f
1156	Inhg@0°c
1158	Mmhg@0°c
2001	Mtorr
2002	Lb/ft <sup>2</sup>

---





2003	Tsi
2004	Psf
2005	Inh2o@60°f
2006	Fth2o@60°f
2007	Cmh2o@4°c
2008	Mh2o@4°c
2009	Cmhg@0°c
2010	Mhg@0°c
2011	Kgf/m <sup>2</sup>



Table 36 error definition

No	Error code	Error description	Definition
1	0	No error	No error
<b>Command error</b>			
2	120	Command parameter error	Command parameter error
3	-108	Parameter not allowed	Too many parameters, or the command without parameters contains parameters
4	-109	Missing parameter	Parameter missed
5	-110	Command header error	Command header error
6	-114	Header suffix out of range	Command header suffix is out of range
7	-123	Numeric overflow	Number overflow, the absolute value of the number exponent is greater than 43
8	-151	Invalid string data	Invalid string, such as mismatched quotes
9	-171	Invalid expression	Invalid expressions, such as mismatched parentheses
<b>Execution error</b>			
10	-200	Execution error	Execution error
11	-221	Settings conflict	Settings conflict
12	-222	Data out of range	Parameter out of the command's range
13	-223	Too much data	Too much data beyond processing capacity
14	-224	Illegal parameter value	Illegal parameter value
15	-230	Data corrupt or stale	Invalid data, or the data is being read, and no valid data has been obtained



No	Error code	Error description	Definition
16	-240	Hardware error	Hardware error
17	-256	File name not found	File name not found
18	-282	Illegal program name	Illegal program name
19	220	Measure error	Measure error
20	221	Failed to set measure function	Failed to set measure function
21	222	Failed to read measure value	Failed to read measure value
22	223		
23	224		
24	240	Control error	Control error
25	241		
26	242		
27	243		
28	260	Calibration error	Calibration error
29	261	Calibration secured	Calibration secured, cannot perform calibration
30	262	Invalid calibration secure code	Invalid calibration secure code
31	263	Missing calibration value	During current/voltage calibration, this error will occur if the calibration value is set without setting the calibration point
32	264	Missing calibration data	This error occurs when the calibration point is set continuously, but the calibration value is not set





No	Error code	Error description	Definition
33	265	Failed to set calibration function	Failed to set calibration function
34	266	Calibration data is not enough	When saving the calibration data, if the calibration data does not reach 3 points, this error will occur
35	271	Setion_name_not_found	Setion name not found
36	272	Key_name_not_found	Key name not found
37	291	Update secured	Update secured
38	292	Invalid update secure code	Invalid update secure code
39	293	Not found the service pack	Not found the service pack
40	294	The service pack unavailable	The service pack unavailable
41	295	Appupdate not found	Appupdate.exe not found
<b>Device related error</b>			
42	-310	System error	System error
43	-311	Memory error	Memory error
44	-350	Queue overflow	Queue overflow
45	-360	Communication error	Communication error
46	301	Internal module is not connected	Internal module is not connected
47	302	External module is not connected	External module is not connected
48	303	Supply module is not connected	Supply module is not connected
49	304	Vacuum module is not connected	Vacuum module is not connected
50	361	Open wlan failed	Open wlan failed





No	Error code	Error description	Definition
51	362	Set wlan address mode failed	Set wlan address mode failed
52	363	Set wlan address failed	Set wlan address failed
53	364	Communication port to wifi module is not open	Communication port to wifi module is not open
54	365	Wlanisnotconnected	Wlan is not connected