



Documenting Multifunction Process Calibrator

ADT226Ex/227Ex
Documenting Multifunction Process Calibrator
-----User Manual
[Version:2212V01]

Additel Corporation



STATEMENT

This user manual provides operating and safety instructions for the ADT226Ex/227Ex Ex-proof Documenting Multifunction Process Calibrator. To ensure correct operation and safety, please follow the instructions in this manual. Additel Corporation reserves the right to change the contents and other information contained in this manual without notice.

Content

Safety instructions.....	1
Special safety requirements.....	2
Standard Compliance.....	4
Ex information.....	4
Intended use.....	8
1. Introduction.....	9
1.1 Product Overview.....	9
1.2 Technical specifications.....	10
1.2.1 General specifications.....	10
1.2.2 Signal measure specifications (Environmental temp.: 20±10°C, 1 year accuracy).....	12
1.2.3 Signal output specifications (Environmental temp.: 20±10°C, 1 year accuracy).....	14
1.2.4 Simulate RTD measure & output accuracy (Environmental temp.: 20±10°C).....	16
1.2.5 Simulate TC measure & output accuracy (Environmental temp.: 20±10°C).....	18
1.4 Accessories included.....	23
1.5 Power supply description.....	24
2. Overview for display and functions.....	25



2.1 Main interface	25
2.1.1 Status bar	26
2.1.2 APPs list	26
2.1.3 Main function guide	26
2.2 Control center	27
2.2.1 Date and battery	27
2.2.2 Diagnostic center and screenshot	28
2.2.3 Shortcut settings.....	29
3. Calibrator.....	30
3.1 Electrical Measurement	32
3.1.1 Voltage measurement.....	32
3.1.2 Current measurement.....	33
3.1.3 Frequency measurement.....	33
3.1.4 Pulse measurement.....	34
3.1.5 Switch measurement	34
3.1.6 Filter	35
3.1.7 Scaling.....	37
3.2 HART	38





3.2.1 Search and connection.....	39
3.2.2 Settings	39
3.2.3 Diagnosis and service	41
3.2.4 Process variable settings.....	48
3.3 Temperature measurement.....	49
3.3.1 TC measurement.....	49
3.3.2 RTD measurement	51
3.4 Pressure measurement.....	52
3.5 Output.....	53
3.5.1 Voltage output.....	53
3.5.2 Current output.....	54
3.5.3 Frequency output.....	54
3.5.4 Pulse output	54
3.5.5 Simulate TC output.....	55
3.5.6 Simulate RTD output	56
3.5.7 Set point output	57
3.5.8 Automatic ramp output	57
3.5.9 Automatic step output.....	58



3.5.10 Manual step output	62
3.5.11 Fine adjustment output	63
4. System settings	64
4.1 Bluetooth communication	64
4.2 Power management	64
4.3 System calibration	64
4.4 Services	65
4.4.1 Maintenance	65
4.4.2 Restore to factory	65
4.4.3 Run information	65
4.4.4 System upgrade	65
4.5 Personalization	66
4.5.1 Sound	66
4.5.2 Language	66
4.5.3 Date & Time	66
4.6 Product information	67
5. Data management	68
6. Task	69



6.1 Calibrating pressure devices.....	70
6.1.1 Dial pressure gauges and digital pressure gauges	70
6.1.2 Pressure transmitters	73
6.1.3 Pressure switches	75
6.1.4 I/P Converter	77
6.2 Calibrating temperature devices	79
6.2.1 Temperature indicators	79
6.2.2 Temperature transmitters.....	81
6.2.3 Temperature transmitter with sensor	84
6.2.4 Temperature switches.....	86
6.2.5 Temperature switch with sensor	89
6.3 Calibrating temperature devices	90
6.3.1 Delta- pressure flowmeters.....	90
6.3.2 Instantaneous flowmeters.....	92
6.3.3 Flow volume totalizers	93
6.3.4 Tachometer/ vortex meters	95
6.4 Calibrating loop devices.....	97
6.4.1 Loop indicators	97



6.4.2 Loop signal source	98
6.4.3 Signal isolator/converters	100
6.4.4 Limit Switches.....	101
7. Applications	104
7.1 Unit converter	104
7.2 Leak test	104
7.2.1 Leak Testing	104
7.3 PSV testing	105
7.3.1 PSV testing.....	106
7.4 Thermal calculation.....	106
7.5 Sensor library.....	106
7.6 Simulating transmitters	107
7.7 Differential pressure (DP) modules	108
7.8 Wiring help.....	109

Figures

Figure 1 Basic Structure.....	21
Figure 2 Adaptor and the power plug	24
Figure 3 Main interface.....	25
Figure 4 Control center.....	27
Figure 5 Diagnostic center	28
Figure 6 Calibrator main screen	31
Figure 7 Voltage/Pulse/Frequency/Switch Measurement	32
Figure 8 Current Measurement	33
Figure 9 Filter settings.....	35
Figure 10 Scaling configurations	37
Figure 11 Internal power+ internal resistor	38
Figure 12 External power + external resistor.....	39
Figure 13 Current loop test.....	43
Figure 14 PVAO zero	44
Figure 15 D/A adjustment.....	45
Figure 16 Range migration.....	46
Figure 17 Sensor trim.....	47



Figure 18 Process variable selection	48
Figure 19 TC measurement	50
Figure 20 RTD measurement.....	51
Figure 21 Voltage, frequency, pulse output	53
Figure 22 Current output	54
Figure 23 Simulate TC Output.....	55
Figure 24 Simulate RTD output.....	56
Figure 25 Automatic Step Output Settings	59
Figure 26 Automatic step customize output points	61
Figure 27 Automatic step customize output points	62
Figure 28 I/P converter.....	77
Figure 29 Temperature transmitter	81
Figure 30 Temperature transmitter with sensor	84
Figure 31 Temperature switch	86
Figure 32 Temperature switch with sensor	89

Safety instructions

Warning:

Normal:

- ◆ Please read the user manual before using the product, especially the Safety Instructions;
- ◆ Please charge the battery when a low to ensure normal operation;
- ◆ Do not expose the battery to fire or short circuit the battery;
- ◆ Before using the product, please check the appearance of the product for any damage;
- ◆ If the product is damaged or malfunctions, do not use it, and contact Additel;
- ◆ Do not touch the metal part of the probes or test cables during use;
- ◆ Please remove unnecessary probe, cable or other accessories before using the product;
- ◆ Do not use damaged or worn cables.

Attention:

To prevent damage this product or the device under test, please carefully follow the instruction manual for use

- ◆ Do not use the instrument in a high vibration environment;
- ◆ Use only the Additel power adaptor and designated battery models;
- ◆ When using with external pressure modules, please refer to the safety instructions



Special safety requirements

1. WARNING – DO NOT OPEN WHEN AN EXPLOSIVE ATMOSPHERE IS PRESENT
2. WARNING – DO NOT CHARGE THE BATTERY IN HAZARDOUS LOCATION
3. WARNING – USE ONLY the approved batteries, see Ex instruction
4. The equipment needs to be protected from high impact energy (do not drop or hit the unit)
5. Do not touch the non-metallic enclosure or touch with the insulating materials only
6. The batteries used in the equipment with same manufacturer, same models and same electrochemical system
7. The conformal coating applied to PCB boards meets the requirements of IEC 60664-1 and IEC 60664-3 by the manufacturer
8. Operating temperature: -20°C to +50°C.
9. USB port only to be used in Non-hazardous areas.
10. The lemo type ports can connect with ADT161Ex pressure modules only, the connected cables and flexible hose used for the external pressure modules are made of insulation materials, so end user should consider the risk of electrostatic discharge during material selection and installation process
11. Metallic parts (only fasteners) presented a maximum capacitance of total 110pF, end user should consider this risk for suitable application
12. No additional input energy limitation is required for Type-C USB port and DC charging port when U_m does not exceed 250V (internal OVP/OCP are designed in line with IEC 60079-11)



13. Do not remove the silicone rubber protective sleeve from the enclosure of equipment in Hazardous areas
14. All intrinsically safe parameters must be observed for different external measuring ports on the different models in accordance with Ex instruction.
15. Intrinsically safe electrical system between IS apparatus and Associated apparatus or other IS apparatus:

Table 1 Intrinsically safe parameter

Item	I.S Interface	External Measuring Instrument	System
Equipment group	IIC	IIC	IIC
Level of protection	ia	ia	ia
Temperature class	T4	T4	T4
Ambient temperature	-20°C~+50°C	-20°C~+50°C	
Voltage	Uo	Ui(30V)	
Current	Io	Ii(100mA)	
Power	Po	Pi(0.75W)	
Cable parameters			
Capacitance	Co	Ci	Cc
Inductance	Lo	Li	Lc
L/R ratio	/	/	/



Grounding	Isolated	Isolated	Isolated
-----------	----------	----------	----------

$$U_o \leq U_i$$

$$I_o \leq I_i$$

$$P_o \leq P_i$$

$$C_o \geq C_i + C_c$$

$$L_o \geq L_i + L_c$$

Standard Compliance

- EN IEC 60079-0:2018
- EN 60079-11:2012
- IEC 60079-0:2017 Edition 7.0
- IEC 60079-11:2011 Edition 6.0

Ex information

- National regulations: ATEX directive 2014/34/EU and IECEx scheme 02
- Certificate No.: TÜV 20 ATEX 8509 X and IECEx TUR 20.0009X
- Ex Marking for EU-Type Examination:  II 1 G Ex ia IIC T4 Ga
- Ex Marking for IECEx CoC: Ex ia IIC T4 Ga



-
- Operating temperature: $-20^{\circ}\text{C}\sim+50^{\circ}\text{C}$
 - IP Rating: IP20
 - I.S Parameters:



Additel 226Ex/ 227Ex

Intrinsically Safe Documenting Multifunction Process Calibrator

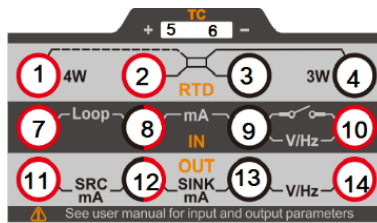

Input parameters, simple connection

Connection	Function	Ui/V	Ii/mA	Pi/mW	Ci/nF	Li/mH
J1-J4	Resistance Measuring and Analog Output	30	100	750	23	0
J5,J6	Thermocouple Measuring and Analog Output	30	100	750	23	0
J7,J9	HART (External Power supply and External Resistance)	30	100	750	10	0
J8,J9	Current Measuring	30	100	750	1	0
J10,J9	Voltage, Frequency AND Switch Measuring	30	100	750	1	0
J7,J8	Loop Circuit Transmitter Current Measuring / HART(Internal Power and Resistance)	30	100	750	10	0

J11,J12	Current Source Output	30	100	750	30	0
J12,J13	Current Sink Output	30	100	750	30	0
J14,J13	Voltage And Frequency Output	30	100	750	30	0

Output parameters, simple connection

Connection	Function	Uo/V	Io/mA	Po/mW	Co/ μ F	Lo/mH
J1-J4	Resistance Measuring and Analog Output	5	10.1	13	82	300
J5,J6	Thermocouple Measuring and Analog Output	5	10	13	82	300
J7,J9	HART (External Power supply and External Resistance)	25.2	79.16	499	0.107	9
J8,J9	Current Measuring	5	0.85	1.1	87	100
J10,J9	Voltage, Frequency AND Switch Measuring	5	0.85	1.1	87	100
J7,J8	Loop Circuit Transmitter Current Measuring / HART(Internal Power and Resistance)	25.2	79.16	499	0.107	9
J11,J12	Current Source Output	21	55	289	0.165	30
J12,J13	Current Sink Output	21	55	289	0.165	30
J14,J13	Voltage And Frequency Output	21	55	289	0.165	30



Intended use

- The equipment is designed to be used in Zone 0 hazardous area with gas group IIC.
- The equipment is designed to be used in oil and gas platforms, oil refineries, chemical and petrochemical plants, pharmaceutical industry, energy and gas processing industries.



1. Introduction

1.1 Product Overview

Additel 226Ex/227Ex series is the intrinsically safe documenting multifunction process calibrator provided by Additel. With functions such as task documentation, HART communication, gauge measurement, signal sourcing, loop power, pressure indication, data logging and a thermal calculator integrated together, it allows users to perform field calibration, troubleshooting, and maintenance with a single device. This can significantly improve the work efficiency of testing and calibration in Ex-proof field applications.

How to contact us

TEL: 1-714-998-6899

Or visit Additel website: www.additel.com



1.2 Technical specification

1.2.1 General specification

Table 2 General specification

Features	Definition
Display	4.4-inch colorful capacitive touch screen, visible under sunlight, with LED backlight
Dimensions	6.97" x 4.13" x 2.04" (177 mm x 105 mm x 52 mm)
Weight	1.65 lb. (0.75Kg)
Keys	1 power key, 4 shortcut keys
Power supply	4000mAh, 14.4Wh Ex-proof Li-ion pack, independent charging.
Charging	Use specific 5V power adaptor, charging time around 6 hours,
Battery life	Typical battery life 35 hours (measure mode)
Environmental condition	Technical assured temperature range: (10~30)°C Working temperature: (-20~50)°C Storage temperature: (-30~70)°C Environmental humidity: 0 % to 95% RH, non-condensing Maximum altitude: 3000m
Warm-up time	Full specification performance is achieved after a 10-minute warm-up time.
Port protection voltage	30V max, see the manual for the intrinsic input/output
Ex-proof level	Ex ia IIC T4 Ga Ta = -20°C~50°C intrinsic safety: ATEX, IECEx

CE certificate	TUV IEC61326, IEC61010
ROHS conformity	ROHS II Directive 2011/65/EU, EN50581:2012
Protection level	IP67,1 meter fall test
Mechanical vibration	5g for low and high frequency
Mechanical impact	8g
Salt spray test	48 hours
Refresh rate	3 times/s
Bus configuration	HART
Communication	Isolated USB-TYPE C (slave),Bluetooth BLE
Environmental measure	built-in barometric sensor (can be calibrated by users, (60~110)kPa. a, annual accuracy ± 55 Pa) and temperature sensor (no accuracy, for reference only)
Electric measure module	<ul style="list-style-type: none"> ▪ voltage measure: ± 300mV, ± 30V ▪ current measure ± 30mA ▪ switch measure ▪ frequency measure: (0.01~50000)Hz ▪ pulse count: 0~9999999 ▪ loop power: 20V
Electric output module	<ul style="list-style-type: none"> ▪ voltage output: (0~10.5)V ▪ current output: (0~25)mA, support SOURCE and SINK ▪ frequency output: (0.01~50000)Hz ▪ pulse output: 0~9999999
Temperature measure & simulate output module	<ul style="list-style-type: none"> ▪ mV measure & output: (-10~75)mV ▪ resistance measure & simulate resistance output: (0~400~4000)Ω ▪ TC measure & TC simulate output ▪ RTD measure & RTD simulate output ▪ Internal CJC measure
External pressure module	Dual channel LEMO ports, support two digital pressure modules



1.2.2 Signal measure specification (Environmental temp.: 20±10°C, 1 year accuracy)

Table 3 Signal measure specification

Specifications	Range	Resolution	Accuracy
Voltage	(-300 ~ 300)mV	1μV	0.01%RD+15μV
	(-30 ~ 30)V	0.1mV	0.01%RD+1.5mV
Current	±30mA	0.1μA	0.01%RD+1.5μA
Frequency	(0.01 ~ 5)Hz	Auto range, 6-digit	0.002%RD+0.00002Hz
	(5 ~ 50)Hz		0.002%RD+0.0002Hz
	(50 ~ 500)Hz		0.002%RD+0.002Hz
	(500 ~ 5000)Hz		0.002%RD+0.02Hz
	(5000 ~ 50000)Hz		0.002%RD+0.2Hz
Pulse	0 ~ 9999999	1	NA
TC	(-10 ~ 75)mV	0.1μV	0.01%RD+3.0μV
Internal CJC temperature	NA	NA	±0.15°C (-10°C ~ 50°C assured)
RTD	(0 ~ 400)Ω	1mΩ	0.01%RD+20mΩ
	(0 ~ 4000)Ω	10mΩ	0.01%RD+200mΩ
Barometric	(60 ~ 110)kPa.a	NA	Annual accuracy: ±55Pa
Switch	Supports dry or wet switches. Voltage range of 3 to 30 V. Response speed < 10 ms		

Note 1: For ADT227Ex/ ADT227Ex-S, when the environmental temperature is (-20~+10) °C and (30~50) °C, the temperature coefficient is:

(1) Measurement of voltage, current, TC and RTD: $\pm 5\text{ppmFS}/^\circ\text{C}$.

Note 2: For ADT227Ex-E, when the environmental temperature is (-20~-10)°C, the temperature coefficient is:

(1) Measurement of voltage, current, TC and RTD: $\pm 5\text{ppmFS}/^\circ\text{C}$.

Note 3: Input characteristics:

(1) Voltage scale: (-300~300)mV input impedance $>100\text{M}\Omega$;

(2) Voltage scale: (-30~30)V input impedance $>1\text{M}\Omega$;

(3) Current measurement: input impedance $<40\Omega$;

(4) TC measurement: input impedance $>100\text{M}\Omega$.

Note 4: The excitation current for RTD measure is 0.2mA, and each position has 4-wire, 3-wire and 2-wire methods. The accuracy is as follows: (given accuracy data in the table in based on 4-wire)

(1) The accuracy of the 3-wire method is 10m Ω more than the accuracy of the 4-wire method;

(2) The accuracy of the 2-wire method is 50m Ω more than the accuracy of the 4-wire method.

Note 5: Minimum threshold voltage for frequency and pulse measure:2.5V

Note 6: Rising edge and falling edge trigger mode is available for pulse measure.



1.2.3 Signal output specification (Environmental temp.: 20±10°C, 1 year accuracy)

Table 4 Signal output specification

Type of signals	Scale	Resolution	Accuracy
Voltage	(0~10.5)V	0.2mV	0.01%RD+0.5mV
Current	(0~25)mA	0.5μA	0.01%RD+1.2μA
Frequency	(0.01~5)Hz	0.00001Hz	0.002%RD+0.00002Hz
	(5~50)Hz	0.0001Hz	0.002%RD+0.0002Hz
	(50~500)Hz	0.001Hz	0.002%RD+0.002Hz
	(500~5000)Hz	0.01Hz	0.002%RD+0.02Hz
	(5000~50000)Hz	0.1Hz	0.002%RD+0.2Hz
Pulse	0~9999999	1	NA
TC	(-10~75)mV	1.5μV	0.01%RD+3.0μV
RTD	(0~400)Ω	10mΩ	0.01%RD+20mΩ
	(0~4000)Ω	100mΩ	0.01%RD+200mΩ
Loop power	Voltage output: 20V±10%, Maximum load current: 25mA		

Note 1: For ADT227Ex/ ADT227Ex-S, when the environmental temperature is (-20~+10)°C and (30~50)°C, the temperature coefficient is:

(1) Measurement of voltage, current, TC and RTD: ±5ppmFS/°C.

Note 2: For ADT227Ex-E, when the environmental temperature is (-20~-10) °C, the temperature coefficient is:

(1) Measurement of voltage, current, TC and RTD: $\pm 5\text{ppmFS}/^{\circ}\text{C}$.

Note 3: Output characteristics:

- (1) Voltage output (0~10.5)V: maximum load current 5mA, loading effect 50 $\mu\text{V}/\text{mA}$;
- (2) Current output (0~25)mA: maximum open current voltage 15V, output impedance 400 Ω , drive capacity 6V/20mA, maximum external voltage 30V;
- (3) Frequency output: positive square wave, 50% duty cycle, square wave amplitude 0~10.5V, amplitude accuracy $\pm 0.2\%$ FS, maximum load current 1mA. Supported units: Hz, kHz, MHz, CPM, CPH, s, ms, us;
- (4) TC output: maximum load current 3mA, loading effect <5 $\mu\text{V}/\text{mA}$;
- (5) RTD output: range of excitation current (0.2~2)mA@(0~400) Ω , (0.1~0.3)mA@(400~4000) Ω , 1ms pulse excite supported.



1.2.4 Simulate RTD measure & output accuracy (Environmental temp.: 20±10°C)

Table 5 Simulate RTD measure & output

Sensor type	Temperature(°C)		Annual accuracy(°C)
PT10(385)	-200~850	-200~200	0.59
		200~600	0.72
		600~850	0.82
PT25(385)	-200~850	-200~200	0.27
		200~600	0.35
		600~850	0.41
PT50(385)	-200~850	-200~200	0.16
		200~600	0.22
		600~850	0.27
PT100(385) PT100(391) PT100(3916) PT100(3926)	-200~850	-200~200	0.10
		200~600	0.16
		600~850	0.20
PT200(385)	-200~850	-200~200	0.32
		200~300	0.34
		300~600	0.41
		600~850	0.48



PT400(385)	-200~850	-200~0	0.15
		0~200	0.18
		200~600	0.25
		600~850	0.30
PT500(385)	-200~850	-200~200	0.16
		200~600	0.22
		600~850	0.27
PT1000(385)	-200~850	-200~200	0.10
		200~600	0.16
		600~850	0.20
Cu10(427)	-200~260	-200~260	0.56
Cu50(428)	-50~150	-50~150	0.13
Cu100(428)	-50~150	-50~150	0.08
Ni100(617) Ni100(618)	-60~180	-60~0	0.06
		0~180	0.05
Ni120 (672)	-80~260	-80~260	0.05
Ni1000	-50~150	-50~150	0.07

Note: The above specification complies with the international temperature scale ITS90, depends on the maximum tolerance of the RTD measurement and simulates signal output.



1.2.5 Simulate TC measure & output accuracy (Environmental temp.: 20±10°C)

Table 6 Simulate TC measure & output

Sensor type	Temperature range(°C)		Annual accuracy(°C)
S	-50~1768	-50~0	0.77
		0~100	0.56
		100~1768	0.47
R	-50~1768	-50~0	0.82
		0~200	0.57
		200~1768	0.42
B	0~1820	200~300	1.51
		300~500	1.00
		500~800	0.62
		800~1820	0.43
K	-270~1372	-250~-200	0.75
		-200~-100	0.24
		-100~600	0.13
		600~1372	0.25
N	-270~1300	-250~-200	1.17
		-200~-100	0.34

		-100~1300	0.22
E	-270~1000	-250~-200	0.41
		-200~-100	0.15
		-100~700	0.10
		700~1000	0.14
J	-210~1200	-210~-100	0.20
		-100~700	0.11
		700~1200	0.17
T	-270~400	-250~-100	0.57
		-100~0	0.12
		0~400	0.08
C	0~2315	0~1000	0.26
		1000~1800	0.45
		1800~2315	0.73
D	0~2315	0~100	0.31
		100~1200	0.27
		1200~2000	0.47
		2000~2315	0.74
G	0~2315	50~100	0.90



		100~200	0.57
		200~400	0.36
		400~1500	0.27
		1500~2315	0.55
L	-200~900	-200~-100	0.12
		-100~400	0.09
		400~900	0.12
U	-200~600	-200~0	0.21
		0~600	0.09
LR	-200~800	-200~0	0.14
		0~800	0.11
A	0~2500	0~1200	0.34
		1200~2000	0.57
		2000~2500	0.83

Note: The above specification complies with the international temperature scale ITS90, depends on the maximum tolerance of the TC mV measurement and simulates signal output.

1.3 Basic Structure

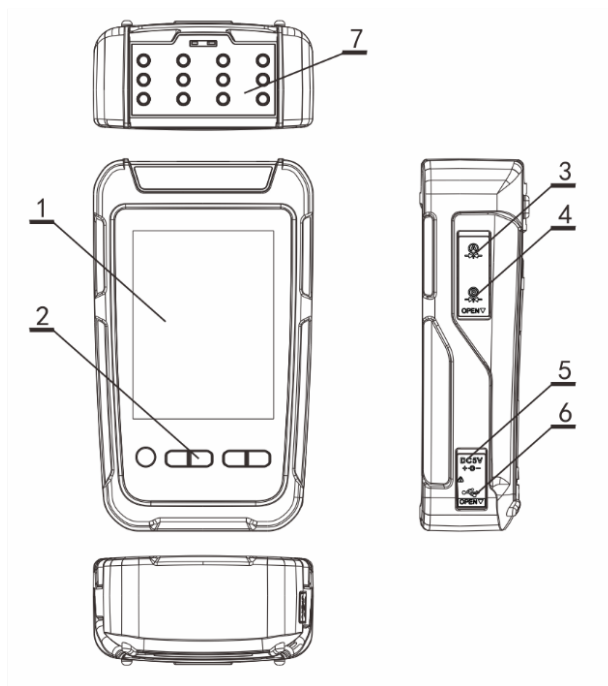

Figure 1 Basic Structure



Table 7 Basic Structure

Subject	Content	Description
1	Display + capacitive touch screen	Display area, touchable
2	Keys	For operating the device
3	LEMO port A	Connect to external pressure module
4	LEMO port B	Connect to external pressure module
5	Adapter port	Power supply from adapter
6	USB slave port	For USB communication
7	Electric test plug	Connection for electric test, including cables and HART communication

1.4 Accessories include

Table 8 Accessories

Accessories		
Standard	Test leads (3 red and 3 black)	1 set
	Ex-proof USB cable type A to C	1 pc
	110V/220V external power adapter (Only for ADT227Ex & ADT227Ex-HART)	1 pc
	Ex-proof intelligent Li battery	1 pc
	ISO 17025 accredited calibration certificate	1 pc
	Pressure module connection cable	1 pc
	Hanging strap with magnet	1 pc
Optional	ADT161Ex module pressure calibrator	
	TC plug and compensation cable	
	Spare Ex-proof intelligent Li battery	
	ACal calibration software	
	Additel/LogII datalogging software	
	Additel/Land data downloading software	
	Hard carrying case for handheld instrument with accessories	



	Soft carrying case, with space for handheld instrument, test leads, and accessories	
--	---	--

1.5 Power supply description

Ex-proof Li-ion battery

- Ex-Proof Li-ion battery is chargeable by external power independently.
- The power adaptor is adaptable for standard in various countries.
- Do not expose the battery to fire or short circuit the battery.
- Use only the Additel power adaptor and designated battery models.



Figure 2 Adaptor and the power plug

2. Overview for display and functions

2.1 Main interface

In the main interface, there are three sections from top to bottom: status bar, APPs list and main function guide. (Figure 3: Main interface)

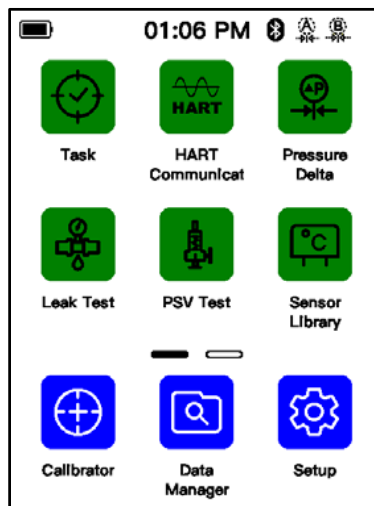













Figure 3 Main interface



2.1.1 Status bar

On the top of the main interface shows the status information, including:

1. System time: real-time of the system;
2. Battery: real-time display the battery level and charging status. Icon  indicates the adaptor is connected.
3. Bluetooth: icon  indicates Bluetooth function is on, while icon  indicates off;
4. Module A: icon  indicates the external module A is connected, while  indicates not connected;
5. Module B: icon  indicates the external module B is connected, while  indicates not connected;
6. Message center: icon  flashes means there is message, warning or abnormal, icon  means no message;
7. 24V status: icon  indicates 24V power supply is on, icon  disappears indicates the 24V power supply is off;
8. Screen lock: icon  means the screen is locked.

2.1.2 APPs list

The APPs list shows all the applications provided in the device, including Task, HART, Pressure Delta, Leak test, PSV test, Sensor library, Unit converter, Simulate transmitter, Thermal calculator and Wiring diagram. Click the button , or use the left and right key to switch between interfaces of the APPs list.

2.1.3 Main function guide

The main function guide at the bottom of the interface provides access to three main functions of the device: calibrator, settings and document management.



2.2 Control center

In any interface of the device, the control center (Figure 4 Control Center) can be called up by physical key . It provides detailed information of date, battery, diagnostic center, screenshot functions, and some shortcuts items.

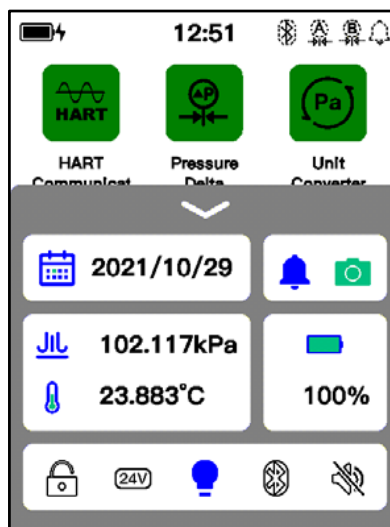





Figure 4 Control center

2.2.1 Date and battery

In the control center, the current date and precise battery percentage is shown.



2.2.2 Diagnostic center and screenshot

Click icon  in the control center to open the diagnostic center, which shows the real-time diagnostic hardware status of the device. If some of the functions fail, check the cause here, as in Figure 5. Click icon  in the diagnostic center to see the historic abnormal log. Click  icon to take the snapshot, which can be viewed or deleted in data management APP.

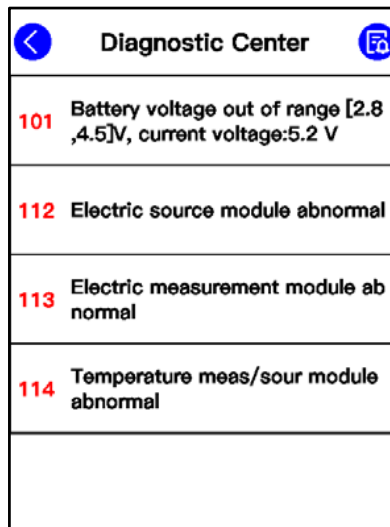







Figure 5 Diagnostic center



2.2.3 Shortcut settings



The control center provides series of shortcut settings:

1. Click icon  to lock the screen, any touch operation and physical keys except the control center and power are invalid during lock.
2. Click icon  to open and close 24V loop power supply.
3. Click icon  to open and close the backlight.
4. Click icon  to open and close Bluetooth.
5. Click icon  to enable and disable system sound.



3. Calibrator

The ADT227EX calibrator can be used to calibrate pressure, loop, temperature, and flow equipment, as shown in Figure 6. The channel 1 at the top of the screen is mainly used for electrical signal measurement functions; The channel 2 at the bottom of the screen is mainly used for electrical signal output functions. Both functions support a variety of electrical signal types. In addition, the upper and lower channels can be used for the display of pressure measurement. Two channels can be displayed simultaneously.

The measured or output signal value is displayed in the middle of the channel. The icon of the signal type and the corresponding range information is displayed on the upper left, click this icon to pop up a menu for switching the signal type; Click the icon  in the upper right corner to set the current channel in the pop-up menu; Click the icon  in the lower right corner to perform the zero operation on the current channel.

If the signal type selected in the channel has multiple values for display (for example, when measuring the TC temperature signal, in addition to the temperature value, there are also the original millivolt signal value and the cold junction temperature value), the channel will also display these signal values below the main signal value.



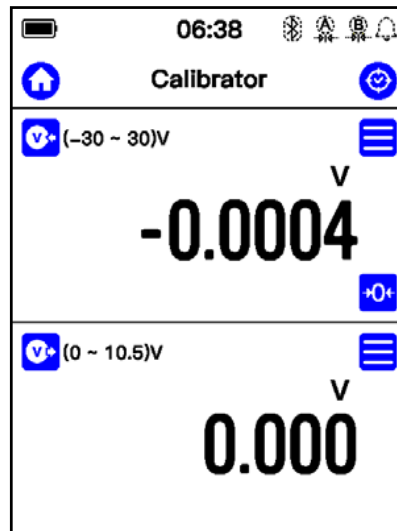

Figure 6 Calibrator main screen

3.1 Electrical Measurement

3.1.1 Voltage measurement

Please connect correctly as shown in the figure (Figure 7 Voltage measurement). Then switch the measurement signal of channel 1 to voltage measurement.

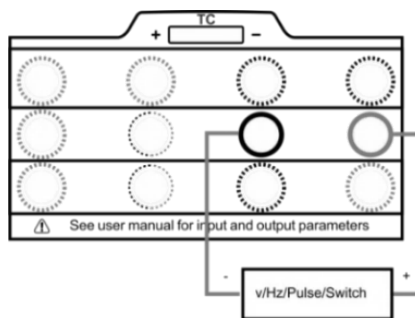



Figure 7 Voltage/Pulse/Frequency/Switch Measurement

In order to ensure measurement accuracy and adapt to more usage scenarios, two different ranges can be selected for voltage measurement in this device: $(-30\sim30)\text{V}$  and $(-300\sim300)\text{mV}$ , the user should select the appropriate measurement item according to the use situation.

3.1.2 Current measurement

Please connect correctly as shown in the figure (Figure 8 Current measurement). Then switch the measurement signal of channel 1 to current measurement (-30~30)mA

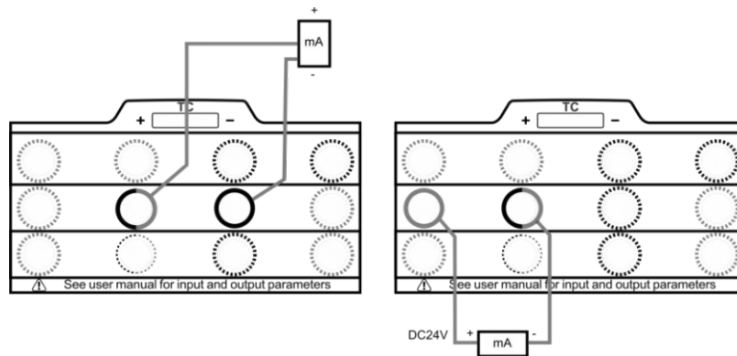



Figure 8 Current Measurement

3.1.3 Frequency measurement

The wiring method of the frequency measurement is the same as the voltage measurement. Please connect correctly as shown in the Figure 7. Then switch the measurement signal of channel 1 to frequency measurement (0.01~50k)Hz



3.1.4 Pulse measurement

The wiring method of the pulse measurement function is the same as the voltage measurement. Please connect correctly as shown in the Figure 7. Then switch the measurement signal of channel 1 to pulse measurement (0 ~9999999) Pulse .

Pulse measurement allows the user to set the pulse counting method. In the pulse measurement mode, enter the setting menu to select whether the pulse counting uses rising or falling edges for counting.

3.1.5 Switch measurement

The wiring method of the switch measurement function is the same as the voltage measurement. Please connect correctly as shown in the Figure 7. Then switch the measurement signal of channel 1 to switch measurement .

When channel 2 selects the appropriate measurement item, the calibrator can display the measured value of channel 2 when the switch action occurs. For example: channel 1 selects switch measurement, channel 2 selects external pressure module for pressure measure. At this time, when the switch channel detects the on-off state change, it will record the pressure value of channel 2 at this time. In this case, the device can be used to calibrate a typical pressure switch device. Click the switch icon in channel 1 or click the "on-off data" option in the channel menu on the right, user can view the last 8 switch action points and the action values measured by the corresponding channel 2 in the pop-up on-off data display page.



3.1.6 Filter

The calibrator provides two filtering methods: first-order linear filtering and moving average filtering to process data to meet the needs of different usage scenarios. Click the menu button  of the measurement channel, select the filter menu item in the pop-up menu, and the filter setting interface will be displayed (see Figure 9).

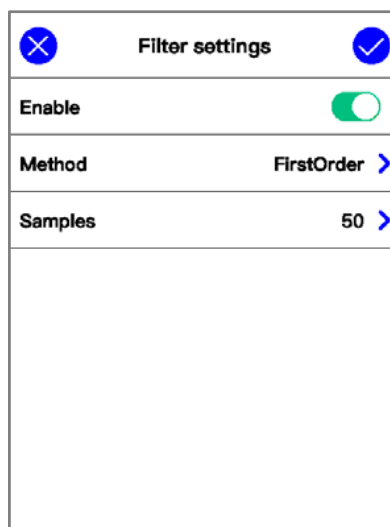

Figure 9 Filter settings



Table 9 Filter Configurations

Subject	Valid Value	Description
Enable/disable	Enable/disable	Enable or disable the filter function
Method	First-order linear filter or moving average filter	Filtering algorithm
Filter coefficient	0 ~ 1	Only available when the first-order linear filter is selected
Number of samples	1~50	Only available when the moving average filter is selected



3.1.7 Scaling

The scaling function gives the calibrator the ability to convert electrical measurement signals into other signals. Click the menu button  of the measurement channel, select the scaling menu item in the pop-up menu, and the parameter configurations related to scaling will be displayed (see Figure 10).

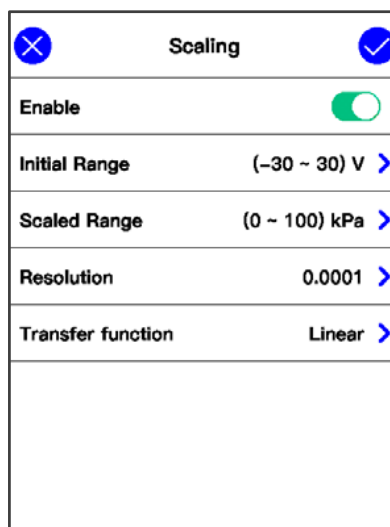

Figure 10 Scaling configurations

Table 9 Scaling configurations

Subject	Valid Value	Description
Enable/disable	Enable/disable	Enable or disable the scaling function
Input range	Number	Range before scaling
Output range	Number	Range after scaling
Resolution	0~0.000001	The number of decimal places displayed after scaling
Transfer function	Linear, square or square root	Scaling transfer function

3.2 HART

Click the HART application icon on the main page or switch the measurement channel to the HART measurement in the main interface of the calibrator to enter the HART communication function. HART communication provides the search, process quantity selection, setting, diagnosis and testing of the transmitter functions. The correct connection method for using the HART communication function is shown in the Figure 11 and 12.

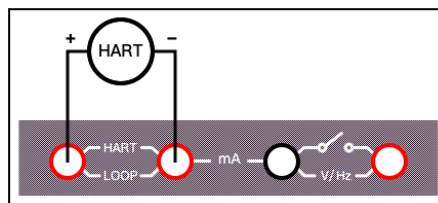

Figure 11 Internal power+ internal resistor

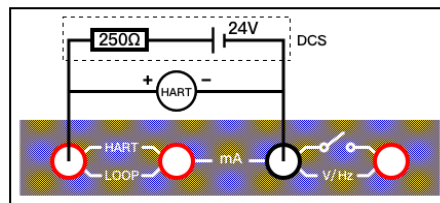



Figure 12 External power + external resistor

3.2.1 Search and connection

Click the manual search option in the calibrator HART measurement channel to enter the power supply mode selection page (if you select the HART application from the main page, the first entry is the power supply mode selection page), in this page you can select the internal power supply with internal resistor or external power supply with external resistor. After selecting the appropriate power supply mode, the system will use the selected power supply mode to search for the connected transmitter. If need to search again, please click the icon  to restart the search.

After the search process, all the detected devices will be displayed in the interface list. Click the device in the list to be able to connect to the corresponding device. After the connection is completed, the transmitter device can be set up and diagnosed.

3.2.2 Settings

The settings items of the transmitter are divided into three categories: device information, sensor information and device output.



1. Device information

Table 10 Transmitter device information

Subject	Valid Value	Description
Manufacturer	Read only	Transmitter manufacturer
Device type	Read only	Transmitter device type
Device ID	Read only	Transmitter model number
Label	Support letter and number input, the length cannot be greater than 8 characters	Transmitter custom label
Date	2000/1/1~2099/12/31	Date setting
Write-protect	Read only	Protection type
Message	Support letter and number input, the length cannot be greater than 20 characters	Custom information
Description	Support letter and number input, the length cannot be greater than 20 characters	Custom description
Final Assembly Number	Support number input, the length cannot be greater than 20 characters	The final assembly number of the transmitter
Preambles	5~20	The preamble number of the transmitter
Universal Version	Read only	Universal version of the transmitter
Software Version	Read only	Software version of the transmitter
Hardware Version	Read only	Hardware version of the transmitter
Device Version	Read only	Device version of the transmitter



2. Sensor information

Read only information on transmitter's unit, upper-lower limits, and the minimum span.

3. Device output

Table 11 Transmitter device output

Subject	Valid Value	Description
Primary Variable/Range Units	°C, °F, °R, K	Measurement unit of the transmitter
Lower Limit of PV Range	Support numeric input, lower limit expanding 10%	Lower limit of the process variable
Upper limit of PV Range	Support numeric input, upper limit expanding 10%	Upper limit of the process variable
Transfer Function	Linear, Square Root	Transfer function of the transmitter
Alarm State	Read only	Alarm state of the transmitter
Damping	Support numeric input, ≥0	Damping time
Poll Address	0~15	Poll address of the transmitter
Burst Mode	Disable, Enable	Burst mode state
Burst Command	1, 2, 3	Burst command depends on different transmitters

3.2.3 Diagnosis and service

The diagnostic/service functions of the HART transmitter include current loop testing, primary variable zeroing, current adjustment, range migration, and sensor trim.

Note: Current loop test, current adjustment, and other diagnostic adjustment functions that involve the use of current loop



as a calibration target are available only when the polling address of the transmitter is 0. These functions cannot be completed in multi-point access mode (when the searching/polling address is 1~15). That is because the current output is fixed at around 4mA under this mode. If adjustment is needed, set the polling address to 0 in the HART settings.

1. Loop test

The current loop test allows users to compare and calibrate the current output signal of the transmitter and the current measurement signal of the device. During the test, the user can input the current measurement signal value of the device through the numeric keyboard or click the button of the specific current value at the bottom of the interface. After that, the device will send the applied current value to the transmitter and display the output current value of the transmitter and the actual current measurement value of the device on the interface. Compare the two; if the value deviation is large, it means the transmitter needs to be calibrated / adjusted.

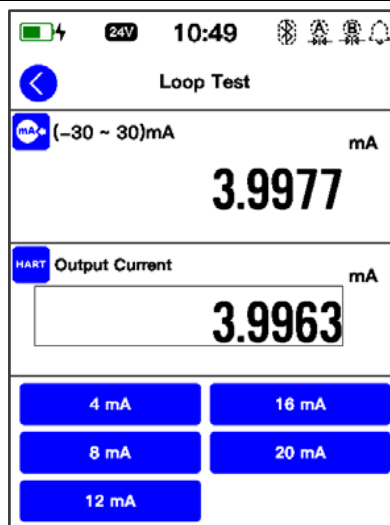

Figure 13 Current loop test

2. Primary variable zeroing

Zero the zero point of the pressure transmitter to correct the zero offset of the transmitter. Under the zeroing mode, please select the pressure module connected to the device as the standard module. Then the upper channel in the interface displays the pressure value output by the transmitter, and the lower channel displays the pressure value measured by the selected standard module of the device.



Click the apply button  on the upper right, the device will send a command to calibrate the transmitter.

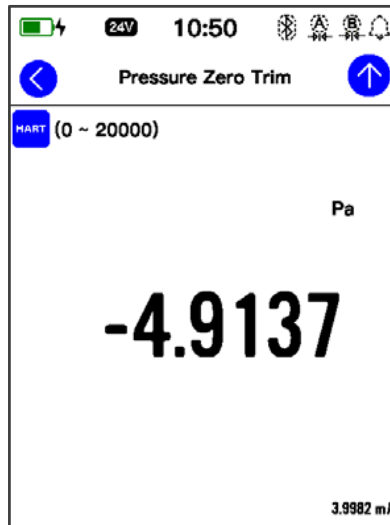



Figure 14 PVAO zero

3. D/A Adjustment

By adjusting the current output of the HART transmitter, the zero-point (4mA) and full span (20mA) output values of the transmitter PVAO are consistent with the actual output loop current value.

Take D/A zero calibration as an example. After entering this calibration mode, the upper channel of the interface



displays the current signal value actually measured by the calibrator, the lower channel displays the current value of PVAO zero point, which is fixed at 4 mA. When calibrating, user can manually enter the measured current value in the adjustment value input box at the bottom or can click the "Fetch" button to automatically obtain the actual measured current signal value of the calibrator. After the adjustment value is set, click the application button  on the upper right, and the calibrator send the adjusted value to the transmitter.

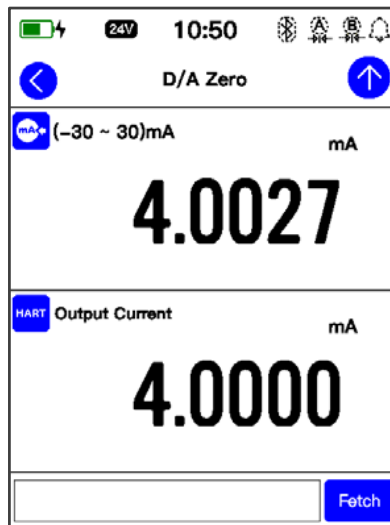

Figure 15 D/A adjustment

4. Re-Rang

The transmitter range migration function allows users to flexibly map the original range of the transmitter.

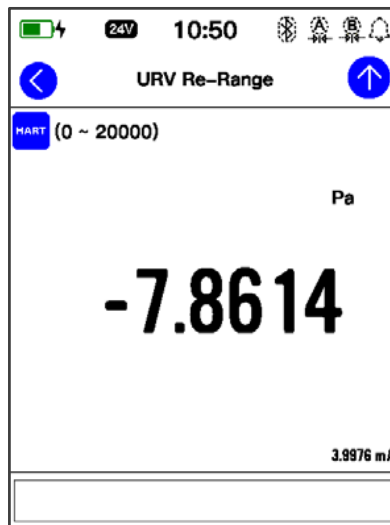

Figure 16 Range migration

5. Sensor trim

The calibrator provides sensor trim function for HART transmitters, which is generally divided into low-end trim and high-end trim. The user can select the appropriate pressure module (built-in module, external module A, external module B) as the pressure standard to adjust the transmitter.

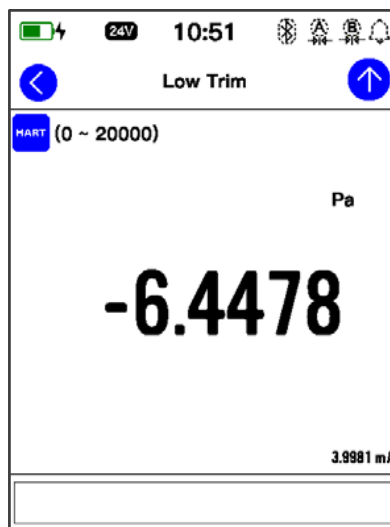

Figure 17 Sensor trim



3.2.4 Process variable setting

The HART transmitter has a variety of process variables to choose from, and the calibrator provides the function of viewing and selecting the process variables of the transmitter.

Process	
PV	-5.8689 Pa <input checked="" type="radio"/>
PVAO	3.9926 mA <input type="radio"/>
%range	-0.0464 % <input type="radio"/>
SV	72.9394 °F <input type="radio"/>
TV	219.1580 psi <input type="radio"/>
Loop Current	3.9977 mA <input type="radio"/>

Figure 18 Process variable selection

Table 12 Hart process variable

Subject	Description
Process Variable	The unit of the process variable depends on the setting of the transmitter. Please refer to transmitter output setting for details
Output current	Transmitter output current, unit: mA
Percentage	The percentage of temperature readout in the temperature range of the transmitter
Loop Current	Loop current of the transmitter, unit: mA
Second variable	The second variable of the transmitter, depends on the settings of the transmitter manufacturer
Third variable	The third variable of the transmitter, depends on the settings of the transmitter manufacturer
Fourth variable	The fourth variable of the transmitter, depends on the settings of the transmitter manufacturer

3.3 Temperature measurement

The calibrator supports thermocouple (TC) and thermal resistance (RTD) temperature measurement.

3.3.1 TC measurement

The connection of thermocouple measurement is shown in the Figure 19 TC measurement. Then click the switching menu of channel 1 and select the TC measurement .

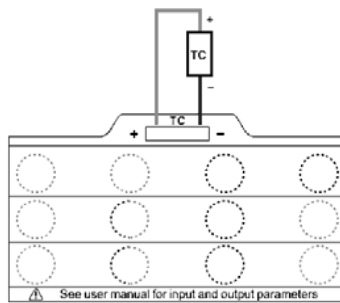



Figure 19 TC measurement

Click the "Setup" button of the TC measurement channel to set various parameters for the thermocouple measurement function.

Table 13 TC measurement settings

Subject	Valid Value	Description
Sensor type	All supported TC types	Select the type of thermocouple sensor
Cold junction type	Auto/Fixed	Select the cold junction compensation method, auto means to use the built-in cold junction sensor of the calibrator
Ext CJC value	Numeric Content	Set customer value for the cold junction compensation value, only available when user selects fixed as the cold junction type
Temperature unit	K / °F / °C	Temperature units' selection
Resolution	0-0.001	Temperature display resolution

3.3.2 RTD measurement

The connection of RTD measurement is shown in the Figure 20 RTD measurement. Then click the switching menu of channel 1 and select the RTD measurement .

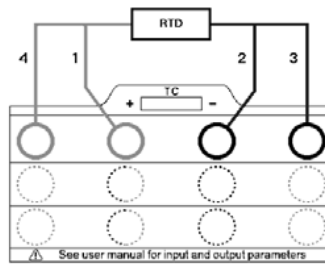

Figure 20 RTD measurement



Click the "Setup" button of the RTD measurement channel to set various parameters for the thermal resistance measurement function.

Table 14 RTD measurement settings

Subject	Valid Value	Description
Sensor type	All supported RTD types	Select the type of thermal resistance sensor
Wires	2/3/4	Select the RTD wire
Temperature unit	K / °F / °C	Temperature units' selection
Resolution	0~0.001	Temperature display resolution



3.4 Pressure measurement

The pressure measurement function is only available when an external pressure module is connected. This calibrator provides two external module LEMO ports A and B. When a pressure module is connected to port A or B, user needs to select  and  for measurement. Click the pressure unit above the pressure measurement value to switch the pressure unit in the pop-up unit selection interface.

Click the menu button  in the pressure measurement channel and click the "Settings" menu in the pop-up menu to set the pressure type, resolution, stability, tare and other functions of the current pressure measurement channel.

Table 15 Pressure measurement settings

Subject	Valid Value	Description
Resolution	4/5/6	Resolution of current measurement channel
Pressure type	Gauge/absolute	Current measurement channel pressure type
Measurement frequency	1~10Hz	Data acquisition frequency of the current measurement channel
Stability enable	Enable/disable	Turn on/off the stability judgment function
Stability value	Pressure value or percentage of span	A value for judging whether the pressure is stable. If the measured value fluctuates less than this value within the stable time, the calibrator will judge as stable
Stabilization time	Numeric Content	Time to judge the pressure stability
Tare enable	Enable/Disable	Enable or disable tare function
Tare value	Pressure value	Correction value of the tare function

3.5 Output

The calibrator provides a variety of electrical signal output and analog temperature output functions to cope with various usage scenarios and different devices under test. The output function of the calibrator not only supports manual setting of set points for signal output, but also provides two automatic output functions: automatic ramp output and automatic step output, and two convenient manual output functions: manual step output and manual fine-tuning output.

3.5.1 Voltage output

The connection of voltage output is shown in the Figure 21 Voltage, frequency, pulse output. Then click the switching menu of channel 2 and select the (0~10.5V)  .

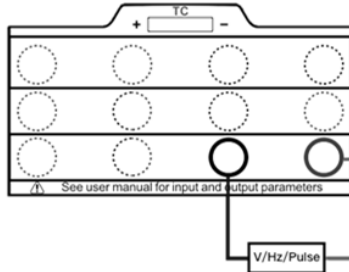



Figure 21 Voltage, frequency, pulse output

3.5.2 Current output

The connection of voltage output is shown in the Figure 22 Current output. Then click the functions switching menu of channel 2 and select the (0~25)mA .

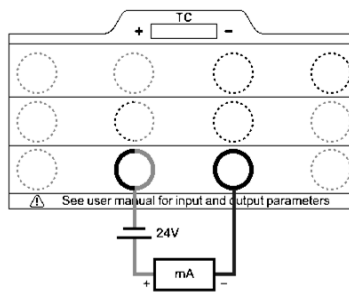



Figure 22 Current output

3.5.3 Frequency output

The connection of frequency output is shown in the Figure 21. Then click the switching menu of channel 2 and select the (0.01~50k)Hz . The frequency output function provides a setting menu, in which the amplitude of the frequency output can be set.

3.5.4 Pulse output

The wiring method of using the pulse output function is the same as the voltage output (Figure 21). After correct wiring

as shown in the figure, click to expand the switching menu of channel 2 and select (1~9999999)  to switch to the pulse output. The pulse output function provides a setting menu, and the amplitude and frequency of the pulse output can be set in the setting menu.

3.5.5 Simulate TC output

The wiring method of simulate TC output is shown in the Figure 23. After correct wiring as shown in the figure, click the switching menu of channel 2 and select the TC  output to use the simulate TC output function.

Click the "Settings" menu item in the simulate TC output menu to enter the simulate TC setting menu. The setting menu provides a variety of settable parameters for the simulate TC output function.

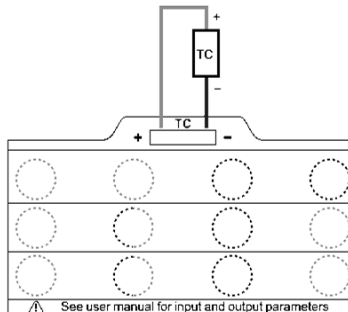

Figure 23 Simulate TC Output

Table 16 Simulate TC Output Setting

Subject	Valid Value	Description
Sensor Type	TC sensor	Select TC sensor
Cold junction type	Auto/ Fix	Select cold junction type, automatically build in the cold junction for the device
Cold junction value	Digital	When the cold junction type is fixed, the cold junction value needs to be input
Temp Unit	K / °F / °C	Select the temperature unit as Kelvin, Fahrenheit or Celsius
Decimal digits	0~0.001	Decimal accuracy of temperature display

3.5.6 Simulate RTD output

The wiring method of simulate RTD output is shown in Figure 24. After correct wiring as shown in the figure, click the switching menu of channel 1 and select the RTD output to use the simulate RTD output function.

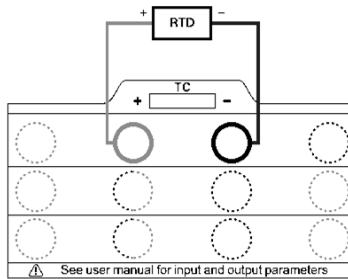



Figure 24 Simulate RTD output

Click the "Settings" menu item in the menu of the simulate RTD output to enter the simulate RTD setting menu. The setting menu provides a variety of parameters for the function.

Table 17 Simulate RTD Settings

Subject	Valid Value	Description
Sensor Type	RTD sensor	Select RTD sensor
Temp Unit	K / °F / °C	Select the temperature unit as Kelvin, Fahrenheit or Celsius
Decimal digits	0~0.001	Decimal accuracy of temperature display

3.5.7 Set point output

Click the signal output value in channel 2 of the calibrator and input the set point value you want to output in the pop-up set point input keyboard and click the confirm button  to set the output value.

3.5.8 Automatic ramp output

The three electrical signal outputs (voltage, current, and frequency of the calibrator) and the simulate RTD/ TC output all support automatic ramp output mode. The Ramp can increase or decrease the output value smoothly and continuously. In fact, a small step value is used to form a Ramp signal, which is represented by a Ramp gradient in the calibrator. The calibrator will automatically calculate the Ramp gradient according to the setting start and end values of the Ramp and the rise and fall time. When the start value and end value are fixed, the longer the ramp time, the slower the ramp output and the smaller the ramp gradient.

A complete ramp output stroke includes an up stroke (from the start value ramp to the end value) and a down stroke



(from the end value ramp to the start value), when the rise time and fall time are the same, the actual output points of the up stroke and the down stroke are symmetrical one by one. In the ramp parameter setting, the start value cannot be equal to the end value, and the values cannot exceed the output range of the current output item (determined by each output function above).

Table 18 Ramp Output Settings

Subject	Valid Value	Description
Range	Number	Ramp start and end value
Rise time	Number (Unit is second)	Up stroke run time
Fall time	Number (Unit is second)	Down stroke run time
High point stay	Number (Unit is second)	High point stay time
low point stay	Number (Unit is second)	Low point stay time
Cycle index	Number (1~100)	Ramp cycle index (a complete up and down stroke is a cycle), if this item is set to 0, it means an infinite cycle.

3.5.9 Automatic step output

The three electrical signal output: voltage, current, and frequency of the calibrator and the simulate RTD/ TC output all support automatic step output mode. In the self-defined step output mode, the calibrator outputs signal in sequence according to the output points set by the user. The automatic step function provides flexible setting items to control the step output behavior and create different types of output points.



Step settings	
Stroke	Oneway Roundtrip
Cycle count	10 >
Cycle interval	5 s >
Dwell time	2 s >
Step mode	Point >
Point count	16 >
Range	(0 ~ 25) mA >

Figure 25 Automatic Step Output Settings

1. Stroke: The stroke mode in the automatic step output mode is divided into one-way mode and round-trip mode. In the single-pass mode, the calibrator outputs signal in sequence from the first output point to the last output point as a complete stroke; in the round-trip mode, the calibrator outputs signal in sequence from the first output point to the last output point, and then from the last output point to the first output point, output in turn, and the two together form a complete stroke.



2. Cycle index: the times of the stroke repeats under the automatic step output, the maximum can be set to 100 cycles. If this item is set to 0, it means infinite loop.

3. Cycle interval: the interval between two strokes in the cycle, in second.

4. Dwell time: the time spent at each output point during the step output stroke, in second.

5. Range: the range of the step output, the range cannot exceed the output range of the current output signal function.

6. Step mode: there are four modes for automatic step output to choose from, namely step point mode, percentage mode, engineering unit (numerical value) and custom mode.

a. Step point mode: In step point mode, the user can set the number of step points, and the calibrator will divide the step range equally according to the number of step points set by the user to obtain the step point.

b. Percentage mode: In the percentage mode, the user can set the step percentage. The calibrator will calculate the step point according to the step percentage and the step range set by the user. The interval between each step point is equal to the range multiplied by this percentage.

c. Engineering unit (numerical step): In this mode, the user is allowed to set the step value, the calibrator calculates the step point according to the step value, and the step length between each step point is the value. Step value unit is the same as the current step range unit.

d. Custom mode: In the custom mode, the user can manually edit each step point. Up to 16 step points can be added, and each step point cannot exceed the output range of the current output signal. After selecting the custom step mode, click the "point list" menu item to enter the set point editing interface (Figure 26 auto step custom output point). In

the custom step output point editing interface, each cell can be modified independently. Click the up and down buttons in the operation bar on the right, or directly enter the step point number, and it can be divided equally within the current step output range to get the corresponding number of output points. In addition, the edit bar also provides functions such as "select", "select all", "reverse selection", "delete", "positive order", "reverse order", etc.

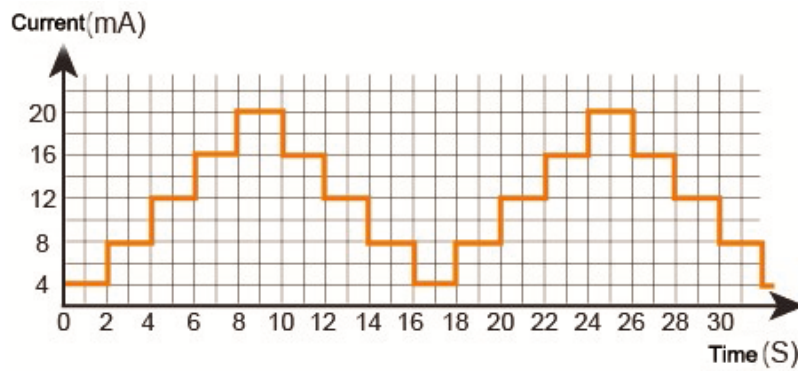

Figure 26 Automatic step customize output points

Set Points	
0	13.3333
1.6667	15
3.3333	16.6667
5	18.3333
6.6667	20
8.3333	21.6667
10	23.3333
11.6667	25

Figure 27 Automatic step customize output points

3.5.10 Manually step output

The current, voltage and frequency output of the calibrator can all be output using the manual step function. Open the setting menu of the corresponding item and click the "Manual step" menu item to enter the manual step mode. The manual step mode allows users to customize the manual step output range, and output according to any percentage step. Click the left or right button under the channel to adjust the output value according to the currently set step.





Click the step range value in the middle of the left and right buttons under the channel to pop up the range input interface, where the user can customize the output range of the manual step; the customized step output range cannot exceed the output range of the current signal option.

The step length setting menu button  of manual step is at the bottom right of channel 2, click this button to select the step length of 25%, 100%, or manually input a custom step length by the user.

Click the button  at the top right of channel 2 to exit manual step mode.

3.5.11 Fine adjustment output

The electrical signal outputs (voltage, current, and frequency of the calibrator) and the simulate RTD/ TC output can all be output in the fine-adjustment output mode. Open the setting menu of the corresponding signal and click the "fine adjustment" menu item to enter the fine adjustment output mode. In the fine-adjustment output mode, users can adjust the output value incrementally as needed.

After entering the fine-adjustment mode, click the left and right buttons   below the channel to move the cursor on the output value, and click the up and down buttons   on the right side of the channel to adjust the value of the current cursor position. In the process of adjusting the output value using the fine-tuning output mode, the output value cannot exceed the output range of the current signal option.

Click the button  on the upper right of channel 2 to exit the fine-adjustment output mode.



4. System settings

On the main page of the device, click the system setting button  in the bottom right corner to enter the system settings interface. System maintenance, system calibration, and various basic system settings are provided here.

4.1 Bluetooth communication

The calibrator has the function of Bluetooth communication. Click the "Bluetooth Communication" menu item in the system setting interface to enter the Bluetooth communication setting interface. The Bluetooth communication setting interface provides the enabling and disabling of the Bluetooth communication function and the query function of the Bluetooth device name and physical address.

4.2 Power management

Click the "Power Management" menu item in the system setting interface to enter the power management interface. In the power management interface, the user can enable and disable the screen backlight, set the time to automatically turn off the backlight, and adjust automatic standby and shutdown.

4.3 System calibration

Click the "System Calibration" menu item in the system setting interface and enter the calibration password "123456" in the pop-up password input box to enter the system calibration interface. In the system calibration interface, you can calibrate all the measurement and output signals in the device. The calibration process is as follows:

1. Select the item to be calibrated in the signal list.
2. Using a high-precision standard device, and after fully warming it up, follow the calibration guide in the interface and

64



click the "Start" button to start the calibration.

3. According to the reference calibration point provided on the interface, select the appropriate standard value and enter it.

4. Click the "Finish" button to send the calibration data to the module to complete the calibration.

Click the "Restore" button at the bottom of the calibration interface to restore the field calibration data of the device. Click the "Cancel zero" button below to clear data of the current signal.

4.4 Services

4.4.1 Maintenance

This function is only open for manufacturer.

4.4.2 Restore to factory

Enter the password for this function, default password is 123456.

◆ Restoring to the factory settings will not restore the system calibration data.

4.4.3 Running information

Select this option to view the device running information. It includes the barometric reading, current battery voltage and electric module information.

4.4.4 System upgrade

Users can upgrade the device firmware via the USB-C port.



4.5 Personalization

Click the "Personalization" menu item in the system setting interface to enter the personalized setting interface. In the personalized setting interface, users can set the device's sound, language type, current time and date, and time and date format according to their own preferences.

4.5.1 Sound

Change the sound level by adjusting the volume bar. It also provides sound configuration, as in Table 20.

Table 19 Sound settings

Subject	Valid Value	Comment
Sound enable	On / Off	Sound enable setting
Prompt sound	On / Off	Prompt sound setting
Touch sound	On / Off	Touch sound setting
Over range sound	On / Off	Over range sound setting
Alarm sound	On / Off	Alarm sound setting

4.5.2 Language

The device provides a multi-language user interface. Use this menu to change from the provided languages.

- ◆ After the language is selected, the device needs to be restarted for the changes to take effect.

4.5.3 Date & Time

The device provides customizable settings for time and date, as shown in Table 21.

Table 20 Date & time

Subject	Valid Value	Comment
Date	2000-1-1 ~ 2099-12-31	Date setting
Time	00:00 ~ 23:59	Time setting
Date format	Y-M-D / M-D-Y / D-M-Y	Date format setting
Separator	-, /, .	Date separator setting
24 hours	Enable	24-hour or 12-hour format

4.6 Product information

Product information is read-only information, includes basic information and the module information.

- ◆ Basic information: including model, serial number and system version information.
- ◆ Module information: including EM board version, ES board version and TMS board version.
- ◆ External module information: including external module A and external module B.





5. Data management

On the main page of the device, click the data management button  in the middle of the bottom row to enter the file management interface. The file management interface is classified and managed by functional modules, and the data saved by each function is managed in the corresponding folder, which is convenient for users to browse.



The functional modules that can save data files are: snapshot, PSV test and leak test. In the corresponding folder, the users can open the operation menu through the menu button  in the upper right corner and delete and batch delete the files in it.



6. Task



The calibrator provides a powerful task function, which makes fully automatic calibration possible. At the same time, the calibration data can be automatically collected, stored, and analyzed, and it can be easily executed and viewed repeatedly. Click the task icon  on the main interface of the device or click the task button  at the top right in the calibrator interface to enter the task interface.

The documenting task provides task types for four types of equipment: pressure, loop circuit, temperature, and flow. There are multiple detailed classifications under each task type, and a total of 16 types of DUTs are supported. The process of using the document task function is as follows:

- (1) Create task: Click the add task button  at the top right of the interface, and click the task type you want to create in the pop-up inspection type selection interface.
- (2) According to the task creation interface presented on the interface, input the information needed to create the task accurately and in detail (for example: task name, inspected range, etc.). After completing the information, click the OK button  to save the task information. The tasks created after the task information is saved will be added to the task list in the main interface of the document task.
- (3) Select the task just created and click the "Execute" button in the pop-up interface to run the task. Complete the configuration required for task operation and execute the task according to the guidance of the task operation interface. General tasks can choose to run automatically or manually.



(4) After the task is executed, click the save button  and complete the information required for saving the task data in the pop-up task saving interface. Click the confirm button to save the task data.

(5) For tasks that have been executed and saved task data, the task execution results will be displayed in the task list on the main interface of the document task. The icon  in the task list indicates that the task has failed to execute, and the DUT does not meet the accuracy requirements; the icon  indicates that the task has passed, and the DUT meets the accuracy of the task. Click the task in the task list to view task details, task running data, edit task details, or re-execute the task.

6.1 Calibration pressure devices

6.1.1 Dial pressure gauge and digital pressure gauge

1. Connect to DUT

Connect the external pressure module to the LEMO port A or B.

2. Create the task

Create the corresponding DUT tasks as described above, and fill out the necessary information, as shown below.

Table 21 Pressure gauge task setting

Subject	Valid value	Description
Name	Numbers, letters, symbols	Task name
Task No.	Numbers, letters, symbols	Task number
Model	Numbers, letters, symbols	Model of DUT
Pressure type	GP / AP / DP	Pressure type of DUT
Input range	Numbers	Input range of DUT
Accuracy	0.06%,0.1%,0.16%,0.25%,0.4%,0.6%,1%,1.6%,2.5%,4%,custom	Accuracy of DUT. If choosing custom, the input number means the accuracy level of the dial pressure gauge. For example: input 1.6 for gauge level of 1.6, the range is (0.001~100)%
Resolution	0.05/ custom	The minimum resolution of DUT (custom 0.001~100)
Owner	Numbers, letters, symbols	Owner of DUT
Location	Numbers, letters, symbols	Location of DUT
Note	Numbers, letters, symbols	Additional information



3. Task setting



After starting the task, go to the task setting interface and set the required information for the task to run. If multiple pressure modules are connected, you will also need to select which module to use to perform the task.

Table 22 Task running setting

Subject	Valid value	Description
Set point list	The effective value of the set point pressure depends on the pressure range of the DUT; up to 17 points can be set	Set the calibration point for this task, and the calibrator will automatically set the default calibration points in equal difference according to the range of the DUT and the number of set points. However, you can click the "Set Point List" item to manually set them. At this time, the unit of the set point is consistent with the unit of the DUT. Use the arrow button on the bottom of the screen or click the number of set points and then enter the number of set points through the keyboard to change the number of set points or modify a set point individually.
Cycle times	1, 2, 3	Cycles during calibration
Strokes	One way/ Round trip	Stroke during calibration
Tapping	On/ off	Enable or disable the tapping

4. Start the task

Click "Start" button to start the task.

Click button  or  to switch between lines mode and table mode.

Calibration process:

- 1) After the pressure is controlled to the first set point by the pressure control device, read the displayed value of the DUT and enter it on the task interface.

- 2) Click to go to the next point.
- 3) Repeat step 1 and 2 until the whole task is finished.

5. Finish the task

After the task is finished, the task report will automatically pop up. In the task report page, you can view the detailed data of each set point. Click the save button  at the bottom right of the interface to fill out in the information required, and save the task data of the result, as shown below.

Table 23 Save task data setting

Subject	Valid value	Description
Operator	Numbers, letters, symbols	Information for operator
Date and time	Valid date and time	Date and time of the task performing
Temperature	Number (°C)	Ambient temperature when task performing
Humidity	Number (%RH)	Ambient humidity when task performing
Save as	As found/ As left/ both	Task data type

6.1.2 Pressure transmitter

1. Connect to DUT

- ◆ Connect the external pressure module to the LEMO port A or B.
- ◆ As shown in the Figure 8 (current), 7 (voltage) or 11/12 (HART), connect the DUT output with calibrator's electric module according to DUT output signal type.



2. Create a task

Create the corresponding DUT tasks as described above, and fill out the necessary information, as shown below.

Table 24 Pressure transmitter task setting

Subject	Valid value	Description
Name	Numbers, letters, symbols	Task name
Task No.	Numbers, letters, symbols	Task number
Model	Numbers, letters, symbols	Model of DUT
Pressure type	GP / AP / DP	Pressure type of DUT
Input range	Numbers	Input range of DUT
Output range	Analog signal: 4~20mA, 0~10mA, 0~20mA, 1~5V, 0~5V, 0~10V, custom	Output range of DUT
	HART device: PV, percentage, output current, loop current	
Accuracy	0.05%, 0.1%, 0.2%, 0.5%, 1%, 1.5%, 2%, 2.5%, custom	Accuracy of DUT. If choosing custom, the input number means the accuracy level of this pressure transmitter.
Transfer function	Linear / square / square root	Transfer function of the DUT signal
Owner	Numbers, letters, symbols	Owner of DUT
Location	Numbers, letters, symbols	Location of DUT
Note	Numbers, letters, symbols	Additional information



3. Task setting

Refer to the task setting in paragraph 6.1.1.

4. Start the task

- ◆ Refer to “Start the task” in paragraph 6.1.1.
- ◆ The calibrator will automatically use the measured value of the voltage measurement, current measurement, or the HART measurement according to the DUT output type set by the user, without manual input.

5. Finish the task

Refer to Finish the task in paragraph 6.1.1.

6.1.3 Pressure switch

1. Connect to DUT

- ◆ Connect the external pressure module to the LEMO port A or B. connect the DUT output with calibrator’s electric module as shown in Figure 7.

2. Create the task

Create the corresponding DUT tasks as described above, and fill out the necessary information, as shown below.



Table 25 Pressure switch task setting

Subject	Valid value	Description
Name	Numbers, letters, symbols	Task name
S/N	Numbers, letters, symbols	Task S/N
Model	Numbers, letters, symbols	Model of DUT
Pressure type	GP / AP / DP	Pressure type of DUT
Range	Numbers	Input range of DUT
Accuracy	0.5%, 1%, 1.5%, 2%, 2.5%, 4%, custom	Accuracy of DUT. If choose custom, the input number means the accuracy level of this pressure switch.
Set point	Numbers	Action set point of the DUT
Set action type	Open / closed	Action type of the DUT
Dead band	Numbers	Set the dead band of DUT
Owner	Numbers, letters, symbols	Owner of DUT
Location	Numbers, letters, symbols	Location of DUT
Note	Numbers, letters, symbols	Additional information

3. Task setting

Refer to the task setting in paragraph 6.1.1.

4. Start the task

- ◆ For part of the content, refer to Start the task in paragraph 6.1.1

- ◆ When the pressure switch moves (open/close) during the task, the calibrator will automatically record the pressure value at the moment of the action, without manual input.

5. Finish the task

Refer to Finish the task in paragraph 6.1.1.

6.1.4 I/P Converter

1. Connect to DUT

- ◆ Connect the external pressure module to the LEMO port A or B.
- ◆ As shown in the Figure 28, connect the DUT output with calibrator's electric module.

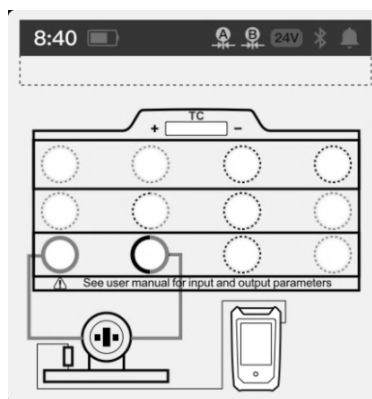

Figure 28 I/P converter



2. Create the task

Create the corresponding DUT tasks as described above, and fill out the necessary information, as shown below.

Table 26 I/P Converter task setting

Subject	Valid value	Description
Name	Numbers, letters, symbols	Task name
S/N	Numbers, letters, symbols	Task S/N
Model	Numbers, letters, symbols	Model of DUT
Pressure type	GP / AP / DP	Pressure type of DUT
Input	(4~20)mA, (4~12)mA, (12~20)mA, custom	Input range of DUT
Output	Numbers	Output range of DUT
Accuracy	0.025%, 0.05%, 0.1%, 0.16%, 0.25%, 0.4%, 1%, 1.6%, 2.5%, 4%, custom	Accuracy of DUT. If choose custom, the input number means the accuracy level of this I/P converter.
Transfer function	Linear / square / square root	Transfer function of the DUT
Owner	Numbers, letters, symbols	Owner of DUT
Location	Numbers, letters, symbols	Location of DUT
Note	Numbers, letters, symbols	Additional information

3. Task setting

Refer to the task setting in paragraph 6.1.1.

4. Start the task

- ◆ For part of the content, refer to Start the task in paragraph 6.1.1
- ◆ During the task performing, the calibrator will output the corresponding current according to the set point list, and automatically record the DUT output pressure, without manual input.

5. Finish the task

Refer to Finish the task in paragraph 6.1.1

6.2 Calibrate temperature devices

6.2.1 Temperature indicator

1. Connect to DUT

- ◆ Connect the DUT input to the TC output (Figure 23) or RTD (Figure 24) output of the calibrator.

2. Create the task

Create the corresponding DUT tasks as described above and fulfill the necessary information.



Table 27 Loop readout task setting

Subject	Valid value	Description
Name	Numbers, letters, symbols	Task name
S/N	Numbers, letters, symbols	Task S/N
Model	Numbers, letters, symbols	Model of DUT
Input	Numbers	Input range of DUT, switchable temperature units
Sensor type	TCs or RTDs optional	Sensor type of the DUT
Accuracy	0.06%, 0.1%, 0.16%, 0.25%, 0.4%, 0.6%, 1%, 1.6%, 2.5%, 4%, custom	Accuracy of DUT
Owner	Numbers, letters, symbols	Owner of DUT
Location	Numbers, letters, symbols	Location of DUT
Note	Numbers, letters, symbols	Additional information

3. Task setting

Refer to the task setting in paragraph 6.1.1.

4. Start the task

- ◆ For part of the content, refer to “Start the Task” in paragraph 6.1.1.
- ◆ During the task, the calibrator simulates and outputs a temperature signal to the DUT, and users need to manually input the value.

5. Finish the task



Refer to "Finish the Task" in paragraph 6.1.1.

6.2.2 Temperature transmitter

1. Connect to DUT

- ◆ Connect the DUT with the measurement and output module of the calibrator, as shown in the Figure 29.

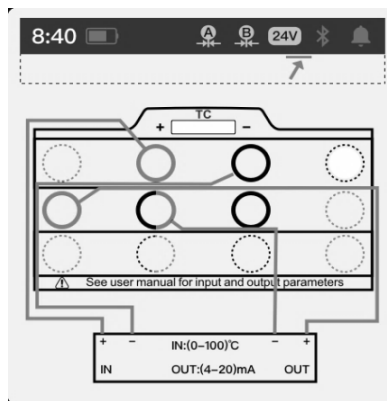

Figure 29 Temperature transmitter



2. Create the task

Create the corresponding DUT tasks as described above and fill out the necessary information.

Table 28 Temperature transmitter task setting

Subject	Valid value	Description
Name	Numbers, letters, symbols	Task name
S/N	Numbers, letters, symbols	Task S/N
Model	Numbers, letters, symbols	Model of DUT
Input	Numbers	Input range of DUT
Sensor	TCs or RTDs optional	Sensor type of the DUT
Output	Analog signal: 4~20mA, 0~10mA, 0~20mA, 1~5V, 0~5V, 0~10V, custom	Output range of DUT
	HART devices: Process variables, percentage, Output current, loop current	
Accuracy	0.06%, 0.1%, 0.16%, 0.25%, 0.4%, 0.6%, 1%, 1.6%, 2.5%, 4%, custom	Accuracy of DUT, the input is customizable
Transfer function	Linear / square / square root	Transfer function of the DUT signal
Owner	Numbers, letters, symbols	Owner of DUT
Location	Numbers, letters, symbols	Location of DUT
Note	Numbers, letters, symbols	Additional information



3. Task setting

Refer to the task setting in paragraph 6.1.1.

4. Start the task

- ◆ For part of the content, refer to “Start the Task” in paragraph 6.1.1.
- ◆ During the task, the calibrator simulates and outputs a temperature signal to the DUT and measures and records the electrical signal output of the DUT. No manual input is required.

5. Finish the task

Refer to “Finish the Task” in paragraph 6.1.1.

6.2.3 Temperature transmitter with sensor

This type of task is for calibrating temperature transmitter with sensor. During calibration, it requires putting the sensor of the DUT into a temperature source (such as an ADT875/878 dry well or thermostatic bath). At the same time, use a reference sensor to connect to the TC/RTD measurement ports on the calibrator, as shown in Figure 30.

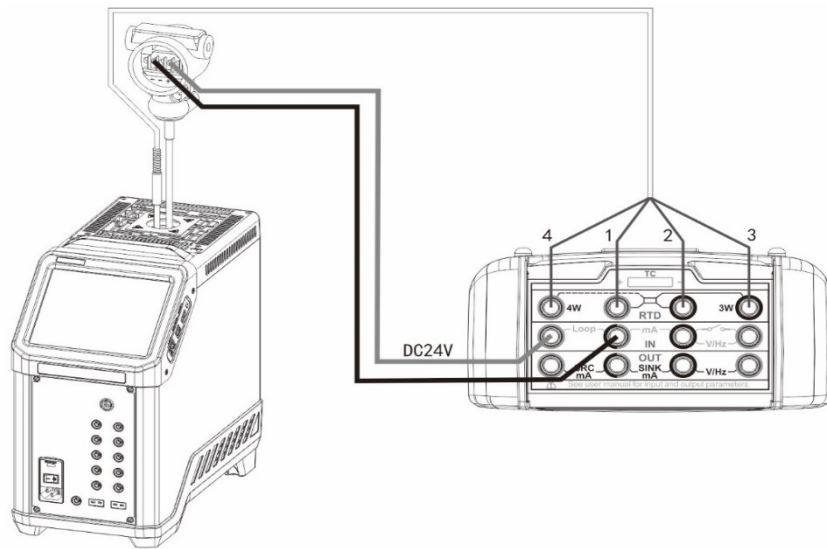

Figure 30 Temperature transmitter with sensor

1. Connect to DUT

- ◆ Refer to Figure 19 or 20 and the type of reference sensor, to measure the TC or RTD. Then refer to Figure 7 or 8 to measure the voltage or circuit based on the transmitter's output type.

2. Create the task

Refer to paragraph 6.2.2.

3. Task setting

Refer to the task setting in paragraph 6.1.1.

4. Start the task

- ◆ For part of the content, refer to "Start the Task" in paragraph 6.1.1.
- ◆ During the task, the calibrator simulates and outputs a temperature signal to the DUT and measures and records the electrical signal output of the DUT. No manual input required.

5. Finish the task

Refer to "Finish the Task" in paragraph 6.1.1.

6.2.4 Temperature switch

This type of task is for calibrating temperature switch without a sensor. It will use the calibrator's simulated temperature output as the sensor.

1. Connect to DUT

- ◆ Connect the DUT with the measurement and output module of the calibrator, as shown in the Figure 31.

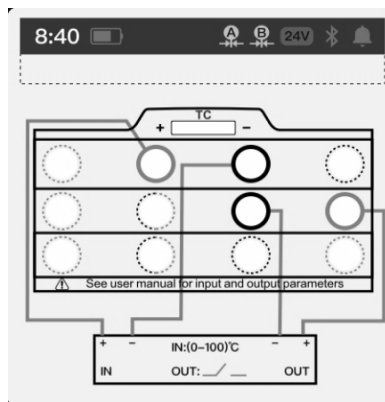

Figure 31 Temperature switch

2. Create the task

Create the corresponding DUT tasks as described above and fill out the necessary information. See below table.

Table 29 Temperature switch task setting

Subject	Valid value	Description
Name	Numbers, letters, symbols	Task name
S/N	Numbers, letters, symbols	Task S/N
Model	Numbers, letters, symbols	Model of DUT
Range	Numbers	Input range of DUT
Sensor	TCs or RTDs optional	DUT sensor type
Accuracy	0.06%, 0.1%, 0.16%, 0.25%, 0.4%, 0.6%, 1%, 1.6%, 2.5%, 4%, custom	Accuracy of DUT, the input is customizable
Set point	Numbers	Action set point of DUT
Set action type	Opened/ closed	Action type of DUT
Dead band	Numbers	Dead band range of the DUT
Owner	Numbers, letters, symbols	Owner of DUT
Location	Numbers, letters, symbols	Location of DUT
Note	Numbers, letters, symbols	Additional information



3. Task setting

Refer to the task setting in paragraph 6.1.1.

4. Start the task

- ◆ For part of the content, refer to “Start the Task” in paragraph 6.1.1.
- ◆ When the DUT moves (opened/closed) during the task, the calibrator will automatically record the temperature output at the moment of the action, no manual input required.

5. Finish the task

Refer to “Finish the Task” in paragraph 6.1.1.

6.2.5 Temperature switch with sensor

This type of task is for calibrating a temperature switch with a sensor. During calibration, it requires to put the DUT into a temperature source (such as an ADT875/878 dry well or thermostatic bath), as shown in Figure 32.

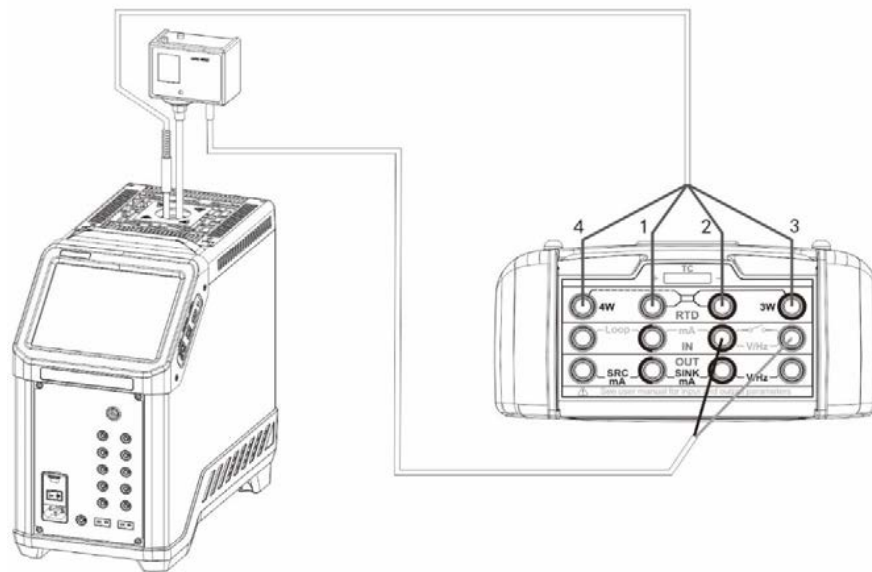

Figure 32 Temperature switch with sensor



1. Connect to DUT

- ◆ Refer to Figure 19 or 20 and the type of reference sensor to measure the TC or RTD. Then refer to Figure 7 to measure the switch signal.

2. Create the task

Refer to paragraph 6.2.4.

3. Task setting

Refer to the task setting in paragraph 6.1.1.

4. Start the task

- ◆ For part of the content, refer to “Start the Task” in paragraph 6.1.1.
- ◆ When the DUT moves (open/close) during the task, the calibrator will automatically record the temperature value at the moment of the action, without manual input.

5. Finish the task

Refer to “Finish the Task” in paragraph 6.1.1.

6.3 Calibrate temperature devices

6.3.1 Delta- pressure flowmeter

1. Connect DUT

- ◆ Connect the external pressure module to the module Lemo port A or B.
- ◆ Connect DUT output with the electrical module of the calibrator according to the signal type of DUT output

(current/ voltage), as shown in the Figure 7 or 8.

2. Create the task

Create the corresponding DUT tasks as described above and fulfill the necessary information. See below table.

Table 30 Delta-pressure flowmeter task setting

Subject	Valid value	Description
Name	Numbers, letters, symbols	Task name
S/N	Numbers, letters, symbols	Task S/N
Model	Numbers, letters, symbols	Model of DUT
Input	Numbers	Input range of DUT
Output	Numbers	Output range of DUT, switch the unit to change the input signal type (current/ voltage)
Accuracy	0.06%,0.1%,0.16%,0.25%,0.4%,0.6%,1%,1.6%,2.5%,4%,custom	Accuracy of DUT, the output is customizable
Transfer function	Linear / square / square root	Transfer function of the DUT signal
Owner	Numbers, letters, symbols	Owner of DUT
Location	Numbers, letters, symbols	Location of DUT
Note	Numbers, letters, symbols	Additional information

3. Task setting

Refer to the task setting in paragraph 6.1.1.



4. Start the task

- ◆ For part of the content, refer to Start the task in paragraph 6.1.1.
- ◆ The calibrator will automatically use the measured value of the voltage or current option according to the DUT output type set by the user, no manual input required.

5. Finish the task

Refer to Finish the task in paragraph 6.1.1.

6.3.2 Instantaneous flowmeter

1. Connect to DUT

- ◆ According to the type of the DUT, connect the DUT input with the current output (Figure 22), voltage/ frequency output (Figure 21) of the calibrator's electrical output module.

2. Create the task

Create the corresponding DUT tasks as described above and fulfill the necessary information. See Table 31.

Table 31 Instantaneous flowmeter task setting

Subject	Valid value	Description
Name	Numbers, letters, symbols	Task name
S/N	Numbers, letters, symbols	Task S/N
Model	Numbers, letters, symbols	Model of DUT
Input	Numbers	Input range of DUT, switch the unit to change the input signal type (current/ voltage/ frequency)



Output	Numbers	Output range of DUT, variety of flow units available
Decimals	Option 0~3	The last decimal digit of the DUT's display
Accuracy	0.06%,0.1%,0.16%,0.25%,0.4%, 0.6%,1%,1.6%,2.5%,4%,custom	Accuracy of DUT, the output is customizable
Transfer function	Linear / square / square root	Transfer function of the DUT signal
Owner	Numbers, letters, symbols	Owner of DUT
Location	Numbers, letters, symbols	Location of DUT
Note	Numbers, letters, symbols	Additional information

3. Task setting

Refer to the task setting in paragraph 6.1.1.

4. Start the task

- ◆ For part of the content, refer to Start the task in paragraph 6.1.1.
- ◆ The calibrator will automatically use the voltage and current output gears to output electrical signals to the DUT according to the type of DUT input set by the users, and the users need to manually input the value of each set point.

5. Finish the task

Refer to Finish the task in paragraph 6.1.1.

6.3.3 Flow volume totalizers

1. Connect to DUT



- ◆ Connect the DUT input with the frequency output module of the calibrator, as shown in the Figure 21.

2. Create the task

Create the corresponding DUT tasks as described above and fulfill the necessary information. See table below.

Table 32 Flow volume totalizers task setting

Subject	Valid value	Description
Name	Numbers, letters, symbols	Task name
S/N	Numbers, letters, symbols	Task S/N
Model	Numbers, letters, symbols	Model of DUT
Frequency	Numbers	Frequency of DUT input signal
Amplitude	Numbers	Amplitude of DUT input signal
Flow unit	Option	Flow unit of DUT, variety of flow units available
Decimals	Option 0~3	The last decimal digit of the DUT's display
Total flow	Numbers	Expected total flow when the task finish
K-Param	Numbers	K coefficient of DUT (The flow rate represented by each signal pulse)
Tolerance	Numbers	Tolerance of DUT
Owner	Numbers, letters, symbols	Owner of DUT
Location	Numbers, letters, symbols	Location of DUT
Note	Numbers, letters, symbols	Additional information

3. Task setting

Refer to the task setting in paragraph 6.1.1.

4. Start the task

- ◆ For part of the content, refer to Start the task in paragraph 6.1.1.
- ◆ The calibrator will automatically generate a continuous pulse output according to user's settings. After all pulse are output, users will need to enter the current accumulative flow value of the DUT into the calibrator.
- ◆ Repeat the above steps until all task cycles finish.

5. Finish the task

Refer to Finish the task in paragraph 6.1.1.

6.3.4 Tachometer/ vortex meters

1. Connect to DUT

- ◆ According to the output signal type of DUT, connect the DUT output with the current measurement (Figure 8) or voltage/ frequency measurement (Figure 7) of the calibrator.

2. Create the task

Create the corresponding DUT tasks as described above and fulfill the necessary information. See table below.



Table 33 Tachometer task setting

Subject	Valid value	Description
Name	Numbers, letters, symbols	Task name
S/N	Numbers, letters, symbols	Task S/N
Model	Numbers, letters, symbols	Model of DUT
Input	Numbers	Input range of DUT, variety of flow units available
Output	Numbers	Output range of DUT, switch the unit to change the output signal type (current/ voltage/ frequency)
Decimal digits	Option 0~3	The last decimal digit of the DUT's display
Accuracy	0.06%,0.1%,0.16%,0.25%,0.4%,0.6%,1%,1.6%,2.5%,4%,custom	Accuracy of DUT, the output is customizable
Transfer function	Linear / square / square root	Transfer function of the DUT signal
Owner	Numbers, letters, symbols	Owner of DUT
Location	Numbers, letters, symbols	Location of DUT
Note	Numbers, letters, symbols	Additional information

3. Task setting

Refer to the task setting in paragraph 6.1.1.

4. Start the task

- ◆ For part of the content, refer to Start the task in paragraph 6.1.1.



- ◆ The calibrator will automatically record the measured signal value at the moment, the current display of DUT needs to be input manually.

5. Finish the task

Refer to Finish the task in paragraph 6.1.1.

6.4 Calibrate loop devices

6.4.1 Loop indicators

1. Connect to DUT

- ◆ Connect the DUT input with the electrical output module of the calibrator, as shown in the Figure 22(for current output) or 21(for voltage output).

2. Create the task

Create the corresponding DUT tasks as described above and fulfill the necessary information. See table below.

Table 34 Loop readout task setting

Subject	Valid value	Description
Name	Numbers, letters, symbols	Task name
S/N	Numbers, letters, symbols	Task S/N
Model	Numbers, letters, symbols	Model of DUT
Range	(4~20)mA,(0~10)mA,(0~20)mA,(1~5)V,(0~5)V,(0~10)V, custom	Input range of DUT
Accuracy	0.025%,0.05%,0.1%,0.16%,0.25%,0.4%,1%,1.6%,2.5%,4%,custom	Accuracy of DUT



Owner	Numbers, letters, symbols	Owner of DUT
Location	Numbers, letters, symbols	Location of DUT
Note	Numbers, letters, symbols	Additional information

3. Task setting

Refer to the task setting in paragraph 6.1.1.

4. Start the task

- ◆ For part of the content, refer to Start the task in paragraph 6.1.1.
- ◆ During the task performing, the calibrator will output the corresponding electrical signal according to the set point and the DUT input type (current/voltage) set by the user. For the measured value at each set point, users need to manually input them.

5. Finish the task

Refer to Finish the task in paragraph 6.1.1.

6.4.2 Loop signal source

1. Connect to DUT

- ◆ Connect the DUT with the measurement module of the calibrator, as shown in the figure 8 (for current measurement) or 7 (for voltage measurement).

2. Create the task

Create the corresponding DUT tasks as described above and fulfill the necessary information. See table below.

Table 35 Loop signal source task setting

Subject	Valid value	Description
Name	Numbers, letters, symbols	Task name
S/N	Numbers, letters, symbols	Task S/N
Model	Numbers, letters, symbols	Model of DUT
Range	(4~20)mA,(0~10)mA,(0~20)mA,(1~5)V,(0~5)V,(0~10)V, custom	Output range of DUT
Accuracy	0.025%,0.05%,0.1%,0.16%,0.25%,0.4%,1%,1.6%,2.5%,4%,custom	Accuracy of DUT
Transfer function	Linear / square / square root	Transfer function of the DUT
Owner	Numbers, letters, symbols	Owner of DUT
Location	Numbers, letters, symbols	Location of DUT
Note	Numbers, letters, symbols	Additional information

3. Task setting

Refer to the task setting in paragraph 6.1.1.

4. Start the task

- ◆ For part of the content, refer to Start the task in paragraph 6.1.1.
- ◆ During the task performing, the calibrator will output electrical signals according to the set point and measure the DUT output signal, no manual input required during the process.

5. Finish the task



Refer to Finish the task in paragraph 6.1.1.

6.4.3 Signal isolator/ converters

1. Connect to DUT

- ◆ Connect the DUT input with the output module of the calibrator, as shown in the figure 22 (for current output) or 21 (for voltage output). Connect the DUT output with the electrical measurement module of the calibrator according to the DUT signal type, as shown in figure 8(Current Measurement) and figure 7(Voltage Measurement).

2. Create the task

Create the corresponding DUT tasks as described above and fulfill the necessary information. See table below.

Table 36 Signal isolator task setting

Subject	Valid value	Description
Name	Numbers, letters, symbols	Task name
S/N	Numbers, letters, symbols	Task S/N
Model	Numbers, letters, symbols	Model of DUT
Input	(4~20)mA,(0~10)mA,(0~20)mA,(1~5)V,(0~5)V,(0~10)V, custom	Input range of DUT
Output	(4~20)mA,(0~10)mA,(0~20)mA,(1~5)V,(0~5)V,(0~10)V, custom	Output range of DUT
Accuracy	0.05%,0.1%,0.2%,0.5%,1%,1.5%,2%,2.5%,custom	Accuracy of DUT
Transfer function	Linear / square / square root	Transfer function of the DUT
Owner	Numbers, letters, symbols	Owner of DUT



Location	Numbers, letters, symbols	Location of DUT
Note	Numbers, letters, symbols	Additional information

3. Task setting

Refer to the task setting in paragraph 6.1.1.

4. Start the task

- ◆ For part of the content, refer to Start the task in paragraph 6.1.1.
- ◆ During the task performing, users need to manually control the electrical signal corresponding to the DUT output according to the set point and input the reading of the DUT electrical signal into the calibrator, the calibrator will give the task result according to the measured value and entered reading as well as the accuracy analysis set by users.

5. Finish the task

Refer to Finish the task in paragraph 6.1.1.

6.4.4 Limit Switches

1. Connect to DUT

- ◆ Connect the DUT input with the output module of the calibrator, as shown in figure 22 (for current output) or 21 (for voltage output).
- ◆ Connect the DUT output with the electrical module of the calibrator, as shown in Figure 7.



2. Create the task

Create the corresponding DUT tasks as described above and fill out the necessary information.

Table 37 Limit switches task setting

Subject	Valid value	Description
Name	Numbers, letters, symbols	Task name
S/N	Numbers, letters, symbols	Task S/N
Model	Numbers, letters, symbols	Model of DUT
Range	(4~20)mA, (0~10)mA, (0~20)mA, (1~5)V, (0~5)V, (0~10)V, custom	Input range of DUT
Accuracy	0.5%, 1%, 1.5%, 2%, 2.5%, custom	Accuracy of DUT
Set point	Numbers	Action set point of DUT
Set action type	Open/ closed	Action type of DUT
Dead band	Numbers	Switch difference range of the DUT(dead band)
Owner	Numbers, letters, symbols	Owner of DUT
Location	Numbers, letters, symbols	Location of DUT
Note	Numbers, letters, symbols	Additional information

3. Task setting

Refer to the task setting in paragraph 6.1.1.

4. Start the task

- ◆ For part of the content, refer to “Start the Task” in paragraph 6.1.1.
- ◆ When the DUT acts (open/close) during the task performing, the calibrator will automatically record the electrical signal value at the moment of the action, no manual input required.

5. Finish the task

Refer to “Finish the Task” in paragraph 6.1.1.



7. Applications

7.1 Units converter

The calibrator provides unit converter for pressure units and temperature units. Users can select multiple pressure units or temperature units for conversion. Click the unit converter icon on the main interface of the device to enter the unit converter. Click  icon on the right top to select and switch between different types of units. Click the unit under the value display to select and switch between different units.

7.2 Leak test

The calibrator provides a pressure leak test function, which can perform self-checking on the seal of the calibrator. Click on the pressure module column to set the test parameters, referring to the table below:

Table 38 Leak test setting

Subject	Valid value	Description
Pressure type	GP/ AP	The pressure type being recorded, view detail according to calibrator's module
Pressure unit	Pressure unit	Select corresponding pressure unit
Waiting time	Numbers	The pressurizing time of external module
Test time	Numbers	Total record time
Unit of the rate	Second/ minute	Displayed unit after calculation

7.2.1 Leak Test Performing

1. Connect to air circuit



- a. Connect the device to the gas circuit;
 - b. Click the start icon at the bottom of the screen, apply pressure to the leak test point;
 - c. Start counting down the waiting time, and record the real-time pressure at the end of the waiting time as the initial pressure;
 - d. Start the test, count down the test time, and start to calculate the real-time leakage, real-time leakage = initial pressure-real time pressure;
 - e. Record the pressure at the end of the test time as the end pressure;
 - f. The entire leak detection process ends, and the final leakage = initial pressure - end pressure;
2. The whole process will be displayed in stages in the leak curve at the bottom of the screen.

7.3 PSV test

The calibrator provides function of PSV test, to test the safety pressure of the safety valves. Click the pressure module on the top, to set relevant parameters, see table below:

Table 39 PSV test setting

Subject	Valid value	Description
Pressure module	Internal pressure module, external module A or B	Select the pressure module
Test time	00:00:00 ~ 00:10:00	Set test time
Pressure unit	Different modules support different pressure units	Select corresponding pressure unit



7.3.1 PSV test performing

1. Connect air circuit
 - a. Connect the device to the air circuit;
 - b. Press the Start icon on the right of the screen to start performing test, apply the pressure gradually to the safety valve;
 - c. Count down the test time and record the real-time pressure value and create the pressure curve, then record the maximum pressure during the process;
 - d. After the countdown completes and the entire leak test process finishes, save the data;
2. The whole process will be shown in the leak test curve at the bottom of the screen

7.4 Thermal calculator

The calibrator provides thermal calculator app, dedicated to variety of industrial TC, RTD and customized types of sensors. Using the thermal calculator, it is easy to convert between temperature and electrical signals of different sensors.

7.5 Sensor library

In order to meet the needs of custom sensor types, the calibrator provides a sensor library function. In the sensor library function, users can define new sensor types according to their needs and set relevant parameters in the sensor. The sensor library supports a total of four types of custom sensors: ITS-90, CVD, RTD and TC.



7.6 Simulate transmitter

The calibrator provides simulate transmitter function, which can easily use the calibrator as a transmitter. Click the simulate transmitter icon on the main interface to enter the simulate transmitter function. Before using it, you should set the transmitter function in the setting menu. The detail is shown below:

Table 40 Simulate transmitter settings

Subject	Valid value	Description
Type of transmitter	Pressure transmitter / TC-temperature Transmitter / RTD- temperature transmitter / signal convertor	Select transmitter type
Initial range	Value (the unit depends on the transmitter type)	Transmitter input range
Resolution	4 / 5 / 6	Transmitter resolution
Scaled range	Value (select frequency, voltage or current as unit)	Transmitter output range
Transfer function	Linear / square / square root	Transfer function
Sensor type	Type of the sensor	Available for RTD & temperature simulate transmitter
Sensor CJC type	Auto / fixed	Available for simulate transmitter
CJC value	-80 ~ 300	Available for TC simulate transmitter
Wires	2 / 3 / 4	Available for RTD-simulate transmitter

After the setting is completed, click the confirm button, and the calibrator will generate the corresponding output signal for the measured input signal based on the set transmission method. The measured signal and the converted output



signal are displayed in the upper and lower channels.

7.7 Differential pressure (DP) module

The calibrator provides the function of differential pressure module, which consists of two external modules (A and B). This provides a convenient DP test solution in a high static pressure environment. The set parameters of the DP module are shown in the table below.

Table 41 DP module setting

Project	Effective value	Description
Enable	Enable/ disable	Enable or disable the differential pressure module. When the differential pressure module is enabled, the differential pressure module channels will be displayed in the related functions channel list.
Resolution	4 / 5 / 6	The resolution of differential pressure
Range	Numbers	Differential module measuring range
Calculate type	A-B or B-A	For the composite mode of differential pressure module, A and B represent external pressure module A and external pressure module B, respectively
Real time data	----- or Real time differential pressure value	The real-time differential pressure value is displayed only when the differential pressure module is enabled and both external pressure modules A and B are online. Otherwise, the real-time differential pressure value is displayed as -----
Zero offset	Zero offset when zeroing	Zero offset when differential pressure module zeroing
External	Module real time pressure	Click to enter to view the module information





module A	values and units	
External module B	Module real time pressure values and units	Click to enter to view the module information

The following functions are also supported in the DP module management.

Zero: when enabling the DP module and both external A and B are online, users can run the zero operation; the zero offset will be saved and use for calculating the differential pressure.

Cancel zero: cancel the zero offset when performing the zero operation, set the zero offset to 0.

7.8 Wiring help

The wiring help function in the calibrator can help users to connect the wires correctly under various working conditions of the calibrator. It can be entered by clicking the "Wiring help " menu in each channel, or by clicking the "wiring help" icon in the main interface of the device.

