



Acuvim-L Series Multifunction Power Meter User's Manual

ACCUEVERGY

1.888.610.7664

 www.calcert.com

sales@calcert.com

Copyright© 2013 V2.02

This manual may not be altered or reproduced in whole or in part by any means without the expressed written consent of Accuenergy.

The information contained in this document is believed to be accurate at the time of publication, however, Accuenergy assumes no responsibility for any errors which may appear here and reserves the right to make changes without notice. Please ask the local representative for latest product specifications before ordering.

[Document #1030E2202 Revision Date: October 2018]

Please read this manual carefully before installation, operation and maintenance of Acuvim-L power meter.

The following symbols in this manual and on Acuvim-L series meters are used to provide warning of danger or risk during the installation and operation of the meters.



Electric Shock Symbol: Carries information about procedures which must be followed to reduce the risk of electric shock and danger to personal health.



Safety Alert Symbol: Carries information about circumstances which if not considered may result in injury or death.



This mark indicates that this product is UL listed.

Installation and maintenance of the Acuvim-L power meter should only be performed by qualified, competent professionals who have received training and should have experience with high voltage and current device.

Accuenergy shall not be responsible or liable for any damages caused by improper meter installation and/or operation.

CONTENTS

Chapter 1: Introduction..... 8

1.1 Functionality 8

1.2 Areas of Application 9

1.3 Meter Overview 9

Chapter 2 Installation 13

2.1 Appearance and Dimensions 14

2.2 Installation Methods 17

2.3 Wiring 20

 2.3.1 Terminal Strips 20

 2.3.2 Power Requirement 23

 2.3.3 Voltage Input Wiring 25

 2.3.4 Current Input Wiring 28

 2.3.5 Frequently Used Wiring Method 30

 2.3.6 Digital Output (DO)..... 34

 2.3.7 Digital Input (DI) 35

 2.3.8 Communication 35

Chapter 3: Meter Display and Parameter Settings 38

3.1 Display Panel and Keys 38

3.2 Metering Data 40

3.3 Statistics Display..... 48

3.4 System Parameter Setting 53

3.5 DO Parameter Setting and Expansion Module Setting (BL, DL, EL) 61

3.6 Ethernet Network Module Settings 68

3.7 DI status Display function 72

3.8 TOU Energy and Maximum Demand Display 73

3.9 Acuvim-L Measurement Methods and Parameter Definitions 76

Chapter 4 Communications 90

4.1 Modbus Protocol Introduction 90

4.2 Modbus Protocol 91

4.3 Communications Format 93

4.4 Ethernet Module (AXM Net) 97

 4.4.1 Introduction to Ethernet 97

 4.4.2 Function Description of Ethernet module 98

 4.4.3 Appearance and Dimensions 98

 4.4.4 Installation Method 100

 4.4.5 Definition of RJ45 Interface 101

 4.4.6 Cable 102

 4.4.7 Connection Method 102

 4.4.8 Initializing Ethernet Module 102

 4.4.9 Searching IP Address of Ethernet Module 107

 4.4.10 Description of Modbus-TCP protocol 108

 4.4.11 Webpage Browsing and Parameter Settings 118

 4.4.12 Email Function 126

 4.4.13 SNMP Function 126

 4.4.14 SNTP Function 132

4.5 Data Address Table 133

Appendix 164

Appendix A Technical Data and Specification 164

Appendix B Ordering Information 168

Appendix C Revision History 170

Congratulations!

You have purchased an advanced, versatile and multifunction power meter. This meter can work as a remote terminal unit (RTU) that contributes to your system's stability and reliability by providing real-time power quality monitoring and analysis. When you open the package, you will find the following items:

1. Acuvim-L power meter 1
2. Terminal Blocks 3 (2 for basic model)
3. [INSERT] Installation Clips 4
4. Product Disk (Manual, Warranty, Software) 1
5. Additional documentation
(Quick Setup Guide, Calibration Certificate) 2

To avoid complications, please read this manual carefully before installation and operation of the Acuvim-L series meter.

Chapter 1 Chapter 1 Introduction.

Chapter 2 Installation and Wiring.

Chapter 3 Meter Display and Parameter Settings.

Chapter 4 Communication Protocols and Modbus Map.

Appendix Technical Data, Specifications and Ordering Information.

Acuvim-L Series Power Meter

Chapter 1 Introduction

1.1 Functionality

1.2 Areas of Application

1.3 Meter Overview

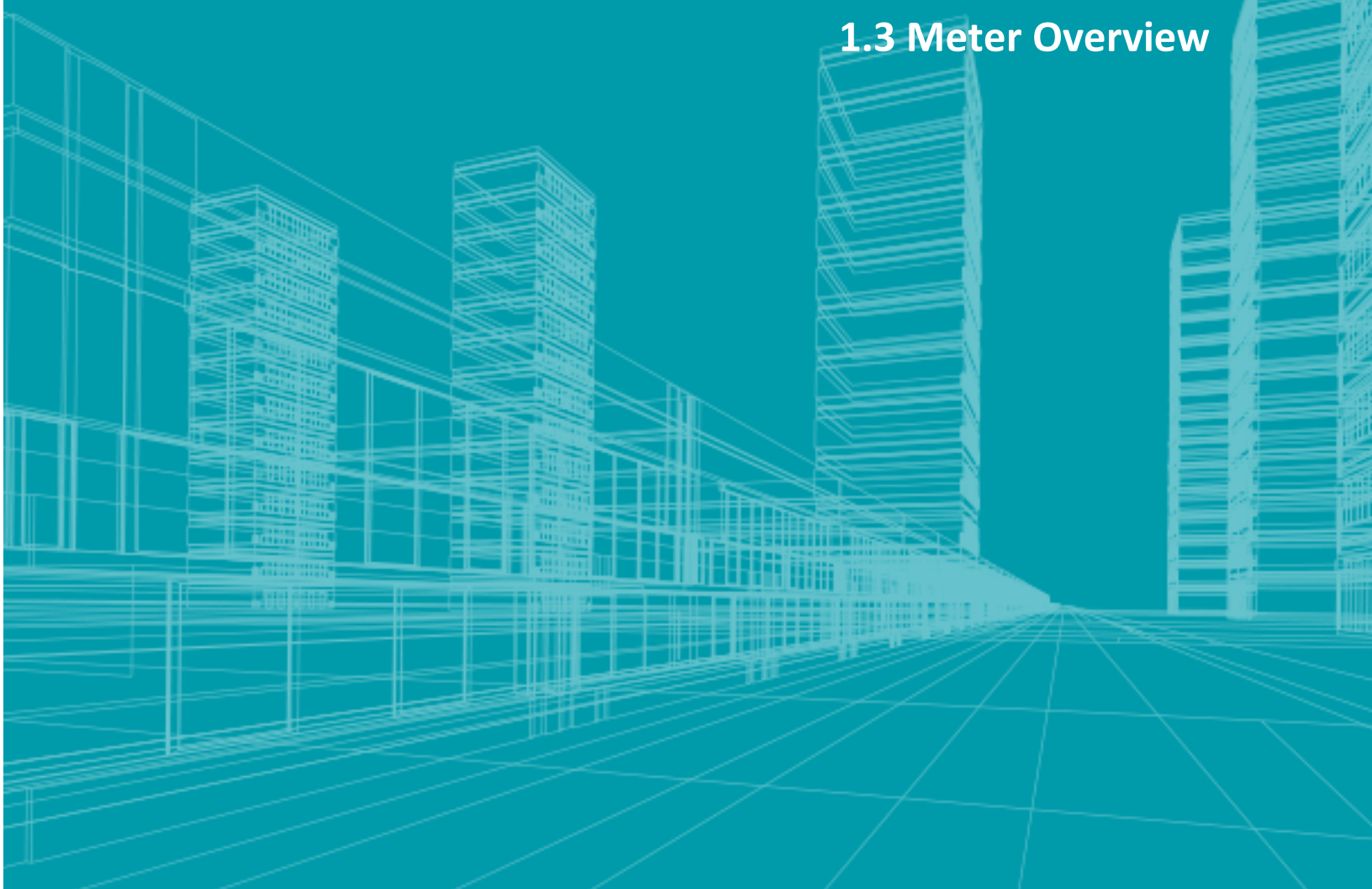

Chapter 1: Introduction

1.1 Functionality

Multifunction, high accuracy

Acuvim-L series multifunction power meter is designed with the latest microprocessor and digital signal process technology. It can measure voltage, current, active power, reactive power, apparent power, power factor for three phases, individual harmonics up to the 2nd or 31th order, THD, real and reactive energy, current and demand and max/min values for real time readings.

The optional Digital Output and RS485 communication can be used for sending energy pulse output and event alarming signals. The RS485 port also can be used for remote meter controlling and data collection. Acuvim-L series meter delivers exceptional metering functionality and provides a cost-effective solution for customers.

Compact and Easy to Install

Acuvim-L series meter can be installed into a standard ANSI C39.1 (4" round) or an IEC 92mm DIN (square) slot. With the 51mm depth, the meter can be installed in a small cabin. Installation clips are used for easy installation and removal.

Easy to use

All metering data and setting parameters can be accessed by using the front panel keys or via the communication port. Setting parameters are stored in the EEPROM so that content will be maintained even when the meter is powered off.

Multiple Wiring Modes

The Acuvim-L series meter can be used in high voltage, low voltage, three phase three wires, three phase four wires and single-phase systems by using different wiring mode settings.

1.2 Areas of Application

Acuvim-L series meter is the ideal choice for replacing traditional, analog electric meters. It uses true RMS measuring methods so that nonlinear load can be monitored. Except providing means of monitoring and measuring power distribution automation system, it can also be used as a remote terminal unit (RTU) for monitoring and controlling a SCADA system. Users can access all measurement parameters via the optional RS485 communication port with Modbus™ protocol. Main application areas Electric Switch Gear and Control Panels include:

- Power Distribution Automation
- Electric Switch Gear and Control Panels
- Industrial Automation
- Building Automation
- Energy Management Systems
- Marine Applications
- Renewable Energy

1.3 Meter Overview

Multifunction

The Acuvim-L series have six standalone models: Acuvim-AL (basic model), Acuvim-BL (basic model + 2DO), Acuvim-CL (basic model + RS485), AcuvimDL (basic model + RS485 + Extend IO), Acuvim-EL(TOU + RS485 + Extend IO) and Acuvim-KL (Simplified Acuvim-CL). Please see table 1-1 for their functionalities and details.

Table 1-1 Functions of Acuvim-L series

Function		Parameters	AL	BL	CL	DL	EL	KL
Real Time Measuring	Voltage	U1, U2, U3,U12, U23, U31	•	•	•	•	•	
	Current	I1, I2, I3,In,(AcuvimKL non-neutral current measurement)	•	•	•	•	•	•
	Power	P1, P2, P3, Psum	•	•	•	•	•	•
	Reactive Power	Q1, Q2, Q3, Qsum	•	•	•	•	•	•
	Apparent Power	S1, S2, S3, Ssum	•	•	•	•	•	•
	Power Factor	PF1, PF2, PF3, PF	•	•	•	•	•	•
	Load Nature	L/C/R	•	•	•	•	•	
	Frequency	F	•	•	•	•	•	
Energy	Energy	Ep_imp, Ep_exp	•	•	•	•	•	
	Reactive Energy	Eq_imp, Eq_exp	•	•	•	•	•	
	Apparent Energy	Es	•	•	•	•	•	
Demand	Current Demand	Dmd_I1, Dmd_I2, Dmd_I3	•	•	•	•	•	
	Power Demand	Dmd_Psum, Dmd_Qsum, Dmd_Ssum	•	•	•	•	•	
TOU	Energy / max demand	TOU, 4 Tariffs, 12 Seasons, 14 Schedules					•	
	Daylight Saving Time	Daylight saving time automatically adjust					•	
	10-year holidays	Up to decade holidays settings					•	
Power Quality	Voltage Unbalance	U_unbl	•	•	•	•	•	
	Current Unbalance	I_unbl	•	•	•	•	•	
	Voltage THD	THD_V1, THD_V2, THD_V3	•	•	•	•	•	
	Current THD	THD_I1, THD_I2, THD_I3	•	•	•	•	•	
	Individual Harmonics	2 nd to 31 th (Voltage and Current)	•	•	•	•	•	
Statistics	Max Current Demand	Dmd_I1_max, Dmd_I2_max, Dmd_I3_max	•	•	•	•	•	
	Max Power Demand	Dmd_Psum_max, Dmd_Qsum_max, Dmd_Ssum_max	•	•	•	•	•	
	Max/Min Voltage	Umax, Umin	•	•	•	•	•	
	Max/Min Current	Imax, Imin	•	•	•	•	•	
Hour	Running Hour	Hour	•	•	•	•	•	•

	Load Running Hour	Hour	●	●	●	●	●	●
I/O	Energy Pulse Output/Alarm Output	2 DO(Standard)		●				
	Expansion I/O module	4DI, 2DO/2RO				⊙	⊙	
COMMUNICATIONS	RS-485	Modbus®-RTU Protocol(Standard)			●	●	●	●
	Ethernet (Extended communication module)	Modbus®-TCP, HTTP, SMTP, SNMP, SNTP				⊙	⊙	
	Second RS-485	Modbus®-RTU Protocol/				⊙	⊙	
	PROFIBUS (Extended communication module)	PROFIBUS-DP (V0) Protocol, according to EN50170 standards				⊙	⊙	

● Possessed functions; ⊙ Optional Functions ; Blank NA

Acuvim-L Series Power Meter

Chapter 2 Installation

2.1 Appearance and Dimensions

2.2 Installation Methods

2.3 Wiring

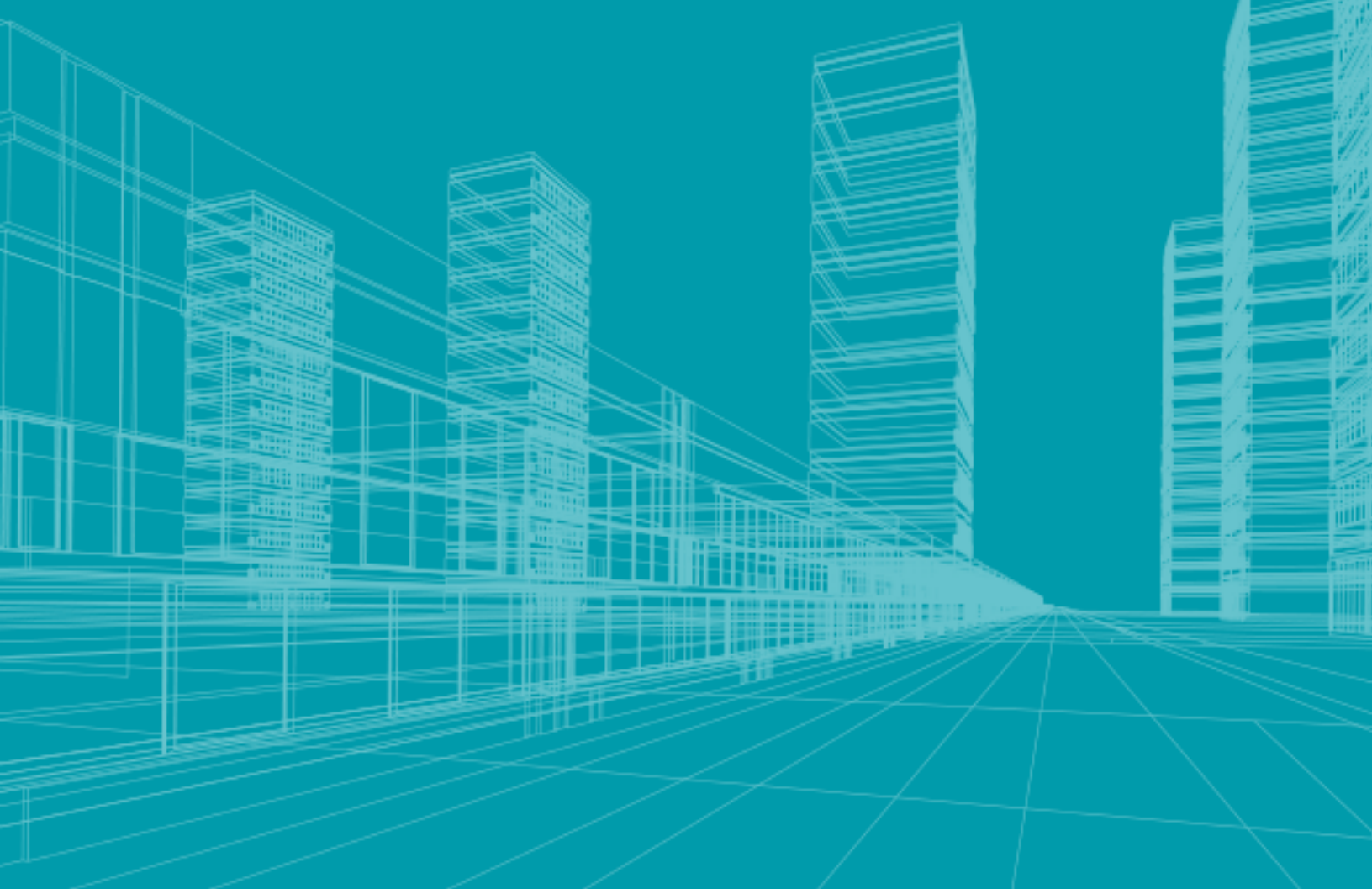

Chapter 2 Installation



Considerations When Installing Meters

- Installation of the meter must be performed by qualified personnel only, who follow standard safety precautions through the installation procedures. Those personnel should have appropriate training and experience with high voltage devices. Appropriate safety gloves, safety glasses and protective clothing are recommended.
- During normal operation, dangerous voltage may flow through many parts of the meter, including: terminals, any connected CTs (Current Transformers) and PTs (Potential Transformers), all I/O (Inputs and Outputs) modules and their circuits. All primary and secondary circuits can, at times, produce lethal voltages and currents. Avoid contact with any current-carrying surfaces.
- The meter and its I/O output channels are NOT designed as primary protection devices and shall NOT be used for primary circuit protection or in an energy-limiting capacity. The meter and its I/O output channels can only be used as secondary protection. AVOID using the meter under situations where failure of the meter may cause injury or death. AVOID using the meter for any application where risk of fire may occur.
- All meter terminals should be inaccessible after installation.
- Do NOT perform Dielectric (HIPOT) test to any inputs, outputs or communication terminals. High voltage testing may damage electronic components of the meter.
- Applying more than the maximum voltage the meter and/or its modules can withstand will permanently damage the meter and/or its modules. Please refer to the specifications for all devices before applying voltages.

The installation method is introduced in the chapter. Please read this chapter carefully before beginning installation.

2.1 Appearance and Dimensions

Units: mm(inches)

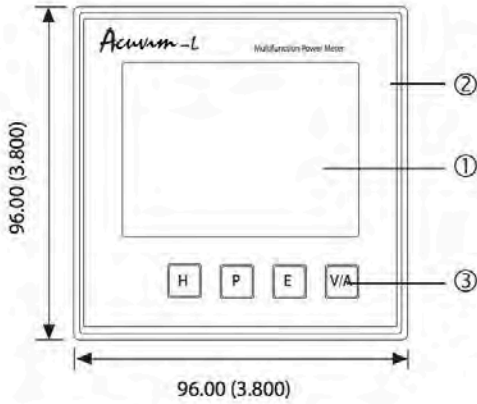

Front View of the Display Meter and Remote Display Unit

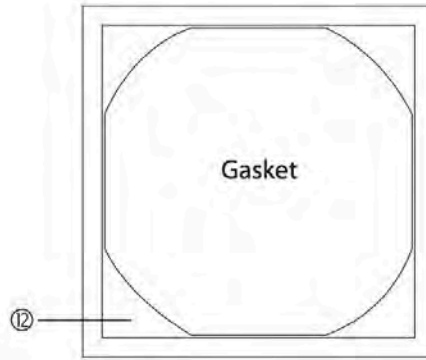

Gasket

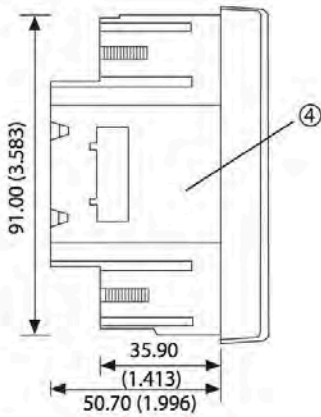

Side View of the Display Meter

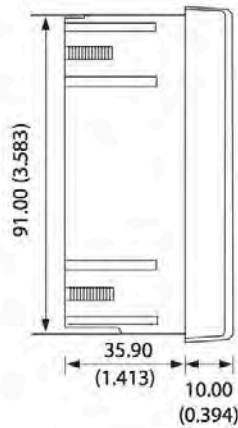

Side View of the Remote Display Unit

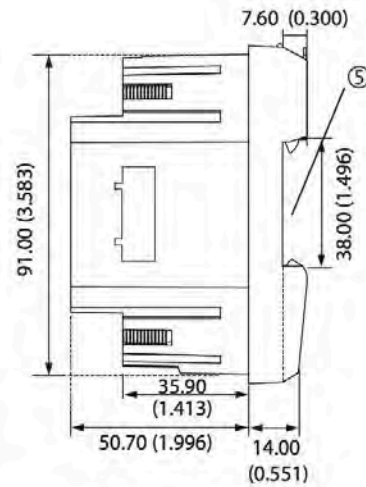

Side View of the DIN rail Meter

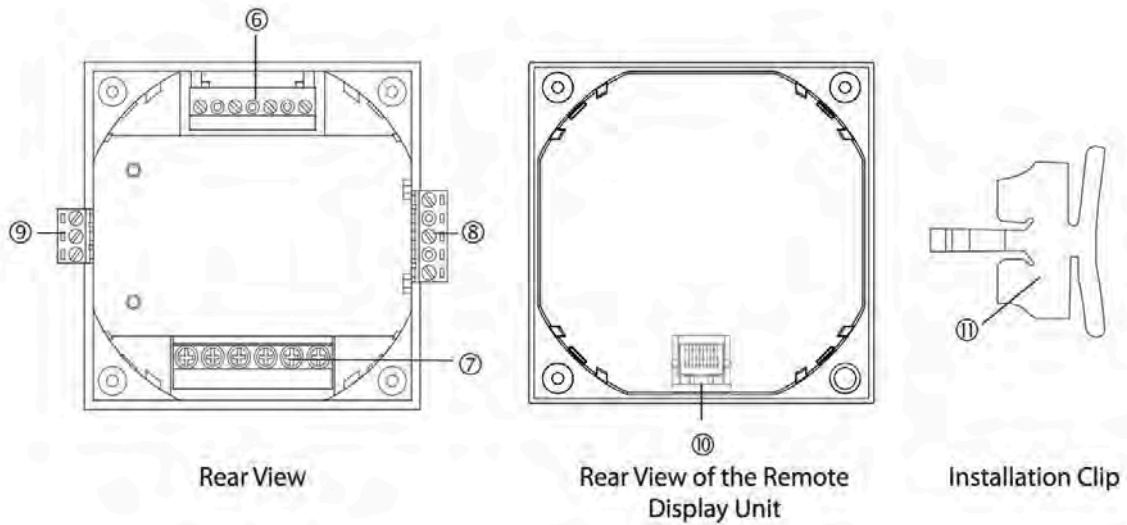

Fig.2-1 Appearance and dimensions

Part Name	Description
1. LCD Display	Large bright white backlight LCD display.
2. Front Casing	Visible portion (for display and control) after mounting onto a panel.
3. Key	Four keys are used to select display and set.
4. Enclosure	The Acuvim-L series meter enclosures is made of high strength anti-combustible engineering plastic.
5. DIN rail	Used for Installation 35mm rail of the DIN rail Meter.
6. Voltage Input Terminals	Used for voltage input.
7. Current Input Terminals	Used for current input.
8. Power Supply Terminals	Used for control power supply input
9. Communication Terminals	Communication output.
10. Interface	Used for link the remote display unit and the DIN rail meter.
11. Installation Clip	Used for fixing the meter to the panel.
12. Gasket	Insert the gasket in between the meter and the cutout to cover up gaps from the round hole.

IO module appearance and mechanical dimensions

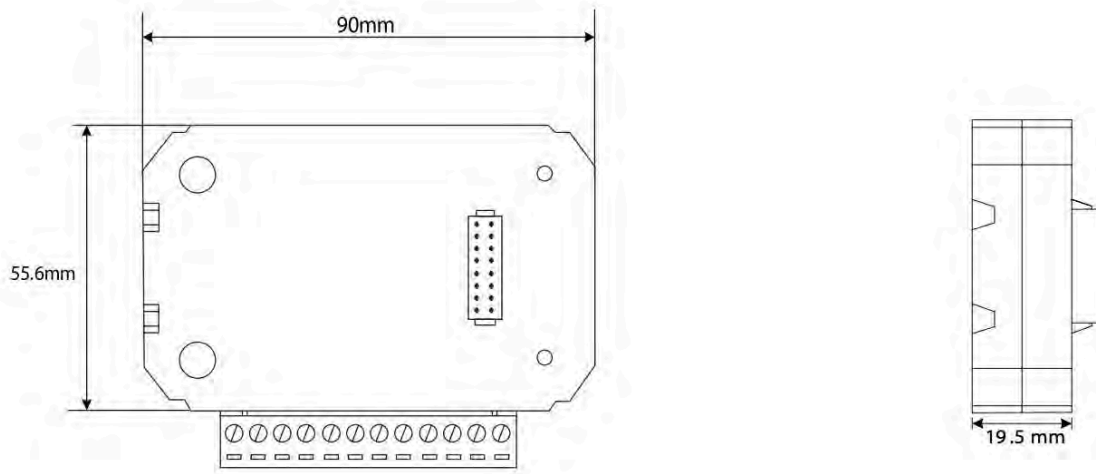

Fig.2-2 structure configuration of IO modules

PROFIBUS module and Ethernet module appearance and mechanical dimensions

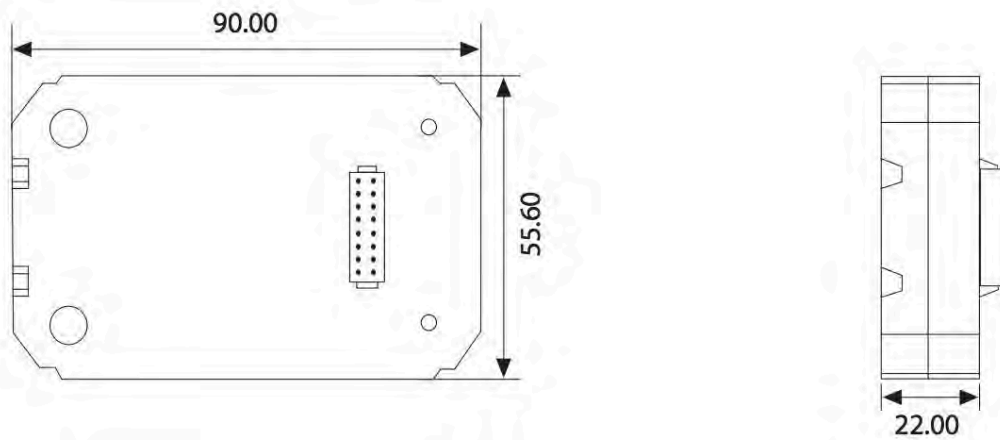



Fig.2-3 structure configuration of PROFIBUS modules

2.2 Installation Methods

 **Note**

Temperature and humidity of the environment must accord with the requirement of acuvim-L, Otherwise it may cause the meter damaged.

Environmental

Please check the environmental temperature and humidity according to Acuvim - L's requirement to ensure the power meter can work well.

Temperature

Operation: -25°C to 70°C.
Storage: -40°C to 85°C

Humidity

5% to 95% non-condensing.

Location

Acuvim-L power meter should be installed in a dry and dust free environment. Avoid exposing meter to excessive heat, radiation and high electrical noise source.

Installation Steps

Acuvim-L series meter can be installed into a standard ANSI C39.1 (4" round) or an IEC 92mm DIN (square) form.

1. Cut a square or round hole on the panel of the switch gear. The cutting size shows as Fig.2-4.

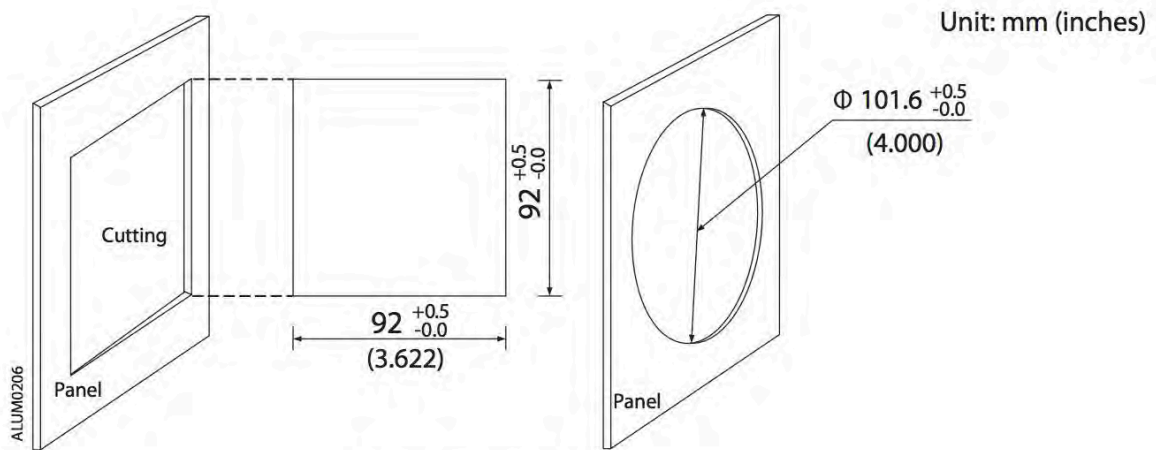

Fig.2-4 Panel cutting

2. Remove the clips from the meter and put Acuvim-L into the square hole from the front side.

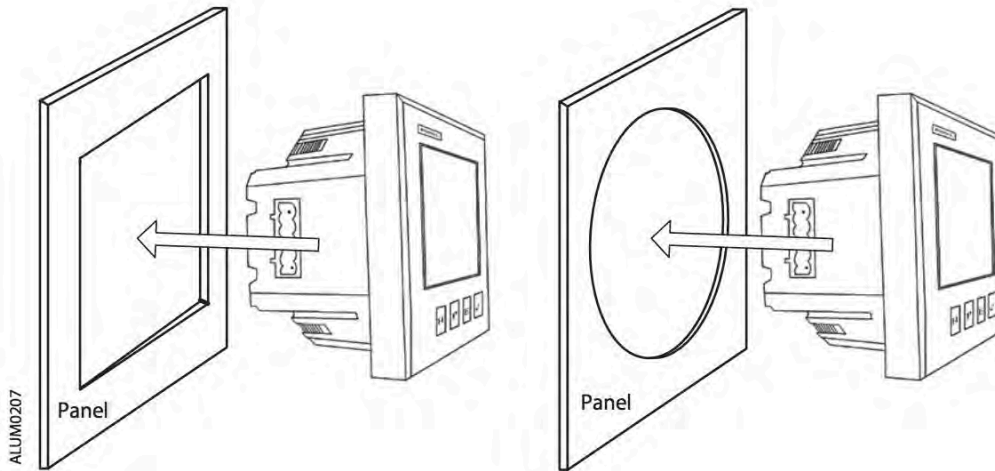

Fig.2-5 Put the meter into the square

Install the clips to the meter from backside and push the clips tightly so that the meter is fixed on the panel.

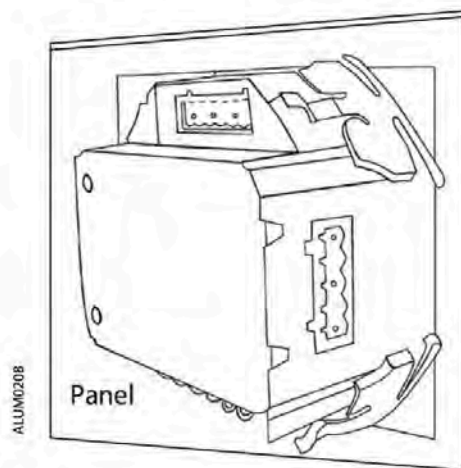

Fig.2-6 Use clips to fix the meter

Module Installation

- (1) The extend module could be installed from the bottom of the meter.
- (2) The extend module is fixed on the meter by the screw.
- (3) Please install the PROFIBUS module first if both IO and PROFIBUS module are selected.
- (4) Please install the Ethernet module first if both IO and Ethernet module are selected.

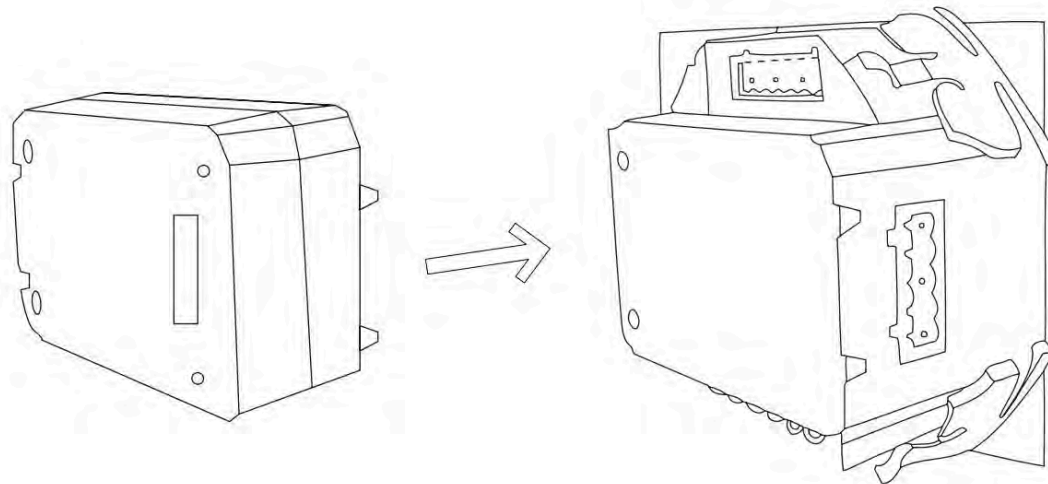

Fig.2-7 IO installation diagram

Note: Acuvim-DL and Acuvim-EL Power meter can connect at most one IO module, one PROFIBUS module and one Ethernet module at the same time.

2.3 Wiring

2.3.1 Terminal Strips

There are three or four terminal strips at the back of the Acuvim-L series meter depending on different models. The terminal strip diagrams are shown in below. The three phase voltage and current are represented by using 1, 2, and 3 respectively. These numbers have the same meaning as A, B, and C or R, S, and T used in other literature.

Current Input Terminal Strip

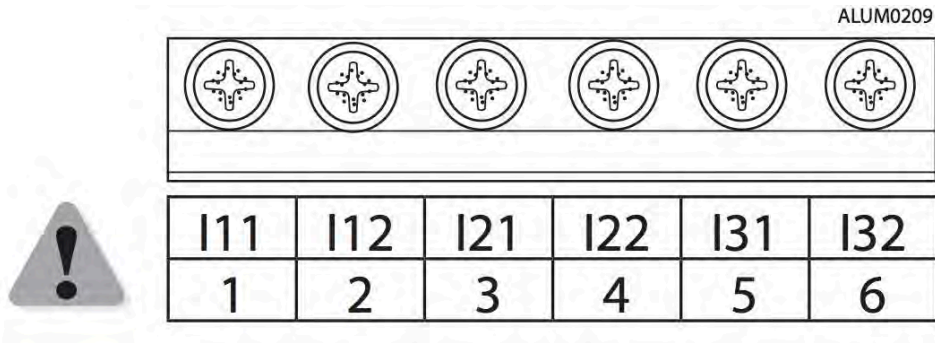

Voltage Input Terminal Strip

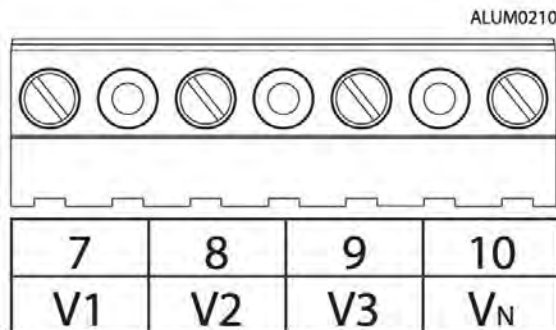

Power Supply Terminal Strip

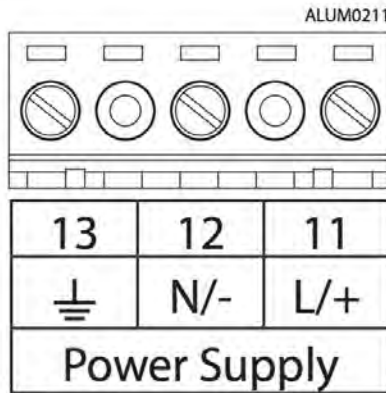

Communication terminal strips

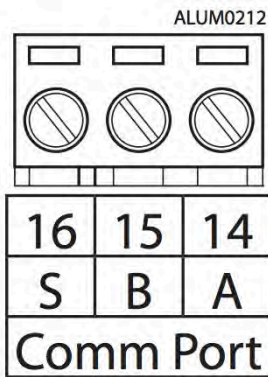

Digital output terminal strips

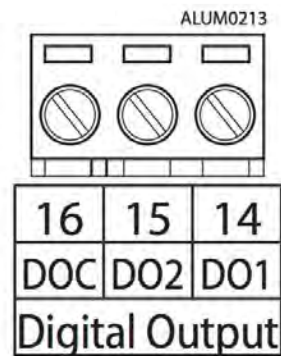

Fig.2-8 Terminal diagram of Acuvim-L

Note: Acuvim-AL does not have digital output and communication terminal strips Acuvim-BL has digital output terminal strip Acuvim-CL/DL/EL/KL have communication terminal strip

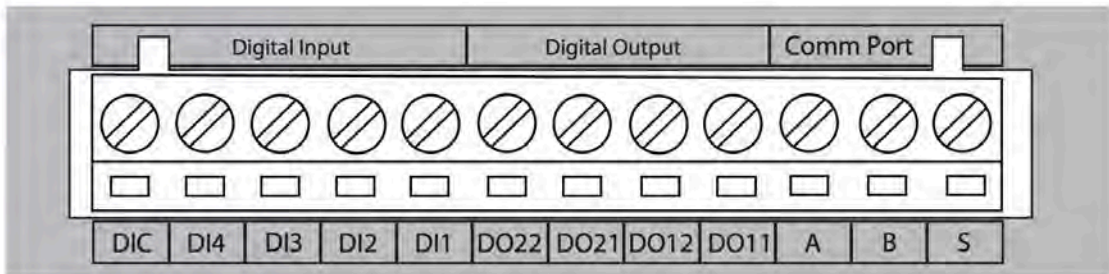



Fig.2-9 Expansion module terminal description

Safety Earth Connection

 **Danger**

Only qualified personnel should perform the wiring connection. Make sure the power supply is disconnected. Failure to follow these instructions may result in severe injury or death.

Before setting up the meter’s wiring, please make sure that the switch gear has an earth ground terminal. Connect both the meter and the switch gear ground terminals together. The following ground terminal symbol is used in this user’s manual.



Fig.2-10 Safety Earth Symbol

2.3.2 Power Requirement

Auxiliary power

There are two Auxiliary Power Supply options for the Acuvim-L series meter:

1. Standard: 100~415Vac (50/60Hz) or 100~300Vdc
2. Low Voltage DC Option: 20-60Vdc

Choose the option according to the application. The meter’s typical power consumption is very low and can be supplied by an independent source or by the measured load line. A regulator or an uninterruptible power supply (UPS) should be used under high power fluctuation conditions. Terminals for the auxiliary power supply are 11, 12 , 13 (L, N, \perp).



Note

Make sure the power supply voltage is within the required auxiliary power supply range.

The typical wiring connection is shown as Fig.2-11.

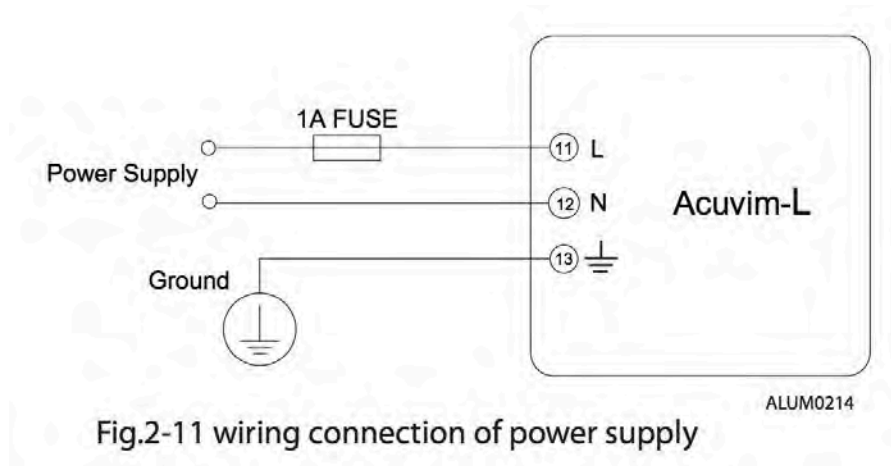

Fig.2-11 wiring connection of power supply

The wire of power supply should be AWG22-16 or 0.6-1.3mm² . A fuse (typical 1A/250Vac) should be used in the auxiliary power supply loop. No.13 terminal must be connected to the ground terminal of switchgear. An isolated transformer or EMC filter should be used in the auxiliary power supply loop if there is a power quality problem in the power supply.

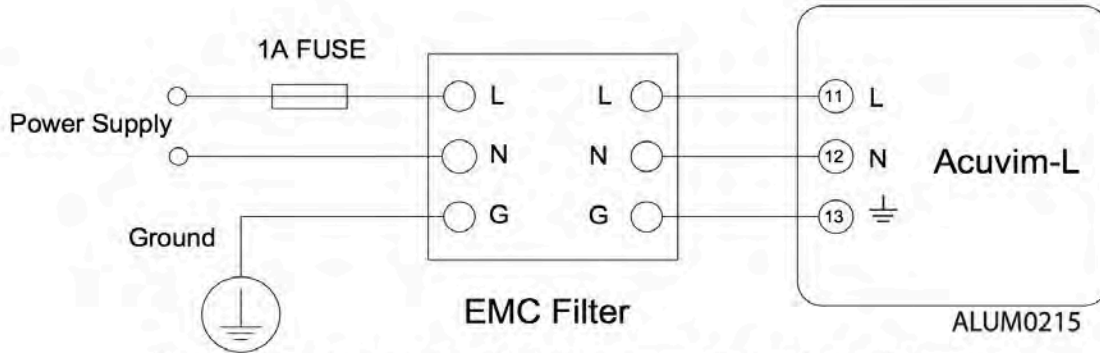



Fig.2-12 wiring connection of auxiliary power supply with EMC filters

Voltage Input

Maximum input voltage for the Acuvim-L series meter shall not exceed 400LN/690LL VAC rms for three phase or 400LN VAC rms for single phase. Potential Transformer (PT) must be used for high voltage systems. Typical secondary output for PTs shall be less than or equal to 400V. Please make sure to select an appropriate PT to maintain the measurement accuracy of the meter.



Note

The secondary of PT can not be shorted; otherwise it may cause severe damages to the instrument.

A fuse (typical 1A) should be used in the voltage input loop. The wire for voltage input could be AWG16-12 or 1.3-2.0mm².

Note: In no circumstance should the secondary of the PT be shorted. The secondary the PT should be grounded at one end.

Please refer to the wiring diagram section for further details.

Current Input

Current Transformers (CTs) are required in most engineering applications. Typical current rating for the secondary side of the CT shall be 5A (standard) or 1A (optional, please refer to the ordering information appendix for further details). CTs must be used if the system rated current is over 5A. The accuracy of the CT should be better than 0.5% with rating over 3VA is recommended in order to preserve the meter’s accuracy. The wire between CTs and the meter shall be as short as possible. The length of the wire may increase the error of the measurement.

The wire size of current input could be AWG15-16 or 1.5-2.5mm².

Note: The secondary side of the CT should not be open circuit in any circumstance when the power is on. There should not be any fuse or switch in the CT loop. One end of the CT loop should be connected to the ground.

Vn connection

Vn is the reference point of the Acuvim-L voltage input. Low wire resistance helps improve the measurement accuracy. Different system wiring modes require different Vn connection method. Please refer to the wiring diagram section for more details.

Three phase wiring diagram

Acuvim-L can satisfy almost all kinds of three phase wiring diagram. Please read this section carefully before choosing the wiring diagram suitable for your power system.

Voltage and current input wiring mode can be set separately in the meter parameter setting process. The voltage wiring mode can be set as 3-phase 4-line Wye(3LN), 3-phase 3-line direct connection mode(3LL), 3-phase 3-line open delta (2LL), single-phase two-line(1LN) and single-phase three-line(1LL). The current input wiring mode can be set as 3CT, 2CT and 1CT. Any voltage wiring setup can be matched with any one of the current wiring setup.

2.3.3 Voltage Input Wiring

3-Phase 4-Line Wye mode (3LN)

The 3-Phase 4-Line Wye mode is popularly used in low voltage electric distribution power system. For voltage lower than 400LN/690LL Vac, power line can be connected directly to the meter's voltage input port as shown in Fig.2-13a. In the high voltage input system, 3PT Wye mode is often used as in Fig.2-13b. The meter should be set to 3LN for both voltage levels.

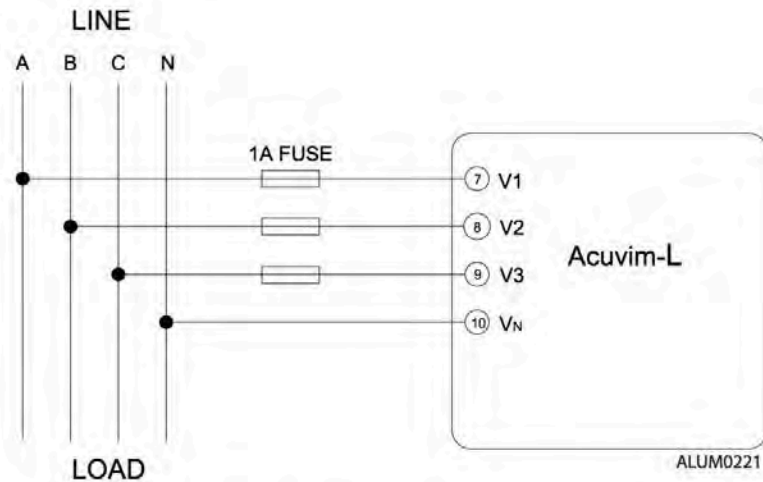

Fig.2-13a 3LN direct connection

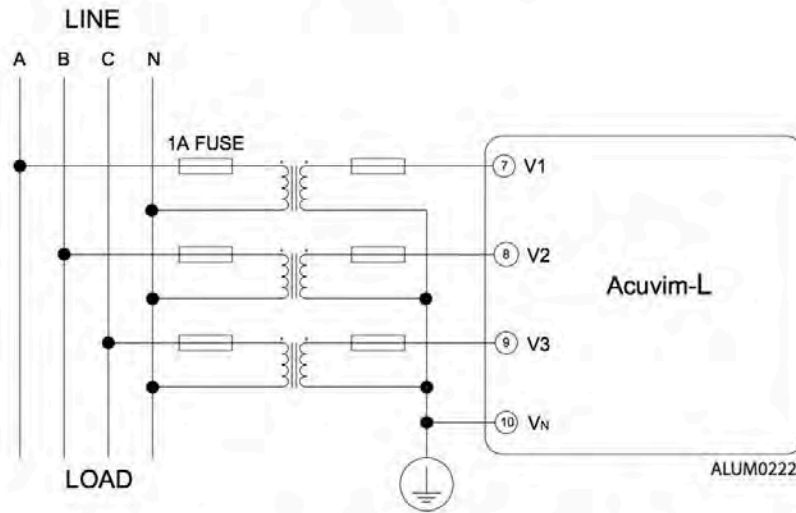

Fig.2-13b 3LN connection with 3PTs

3-Phase 3-Line Direct Connection Mode (3LL)

In a 3-Phase 3-Line system, power line A, B and C are connected to V1, V2 and V3 directly. Vn is floated. The voltage input mode of the meter should be set to 3LL.

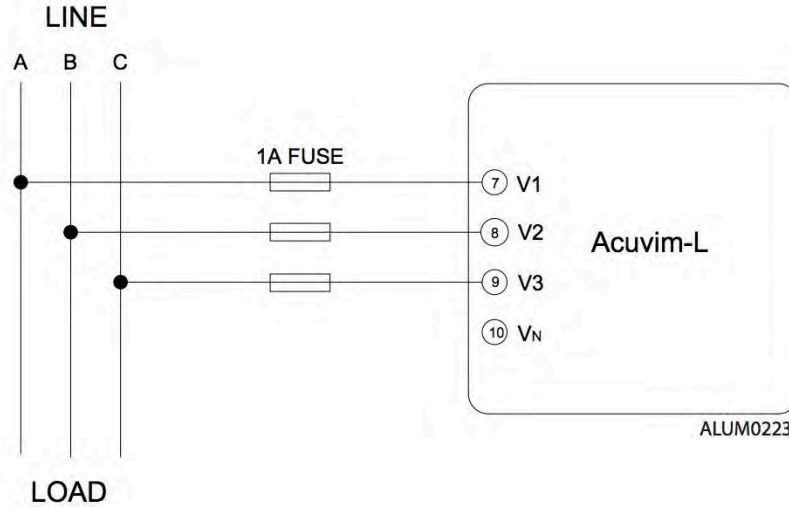

Fig.2-14 3LL 3-phase 3-line direct connection

3-Phase 3-Line open Delta Mode (2LL)

Open delta wiring mode is often used in high voltage system. V2 and Vn connected together in this mode. The voltage input mode of the meter should be set to 2LL for this voltage input wiring mode.

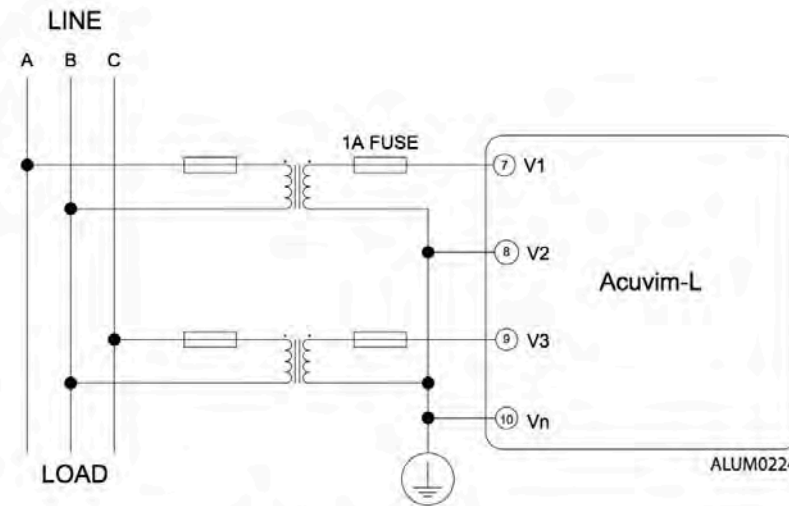

Fig.2-15 2LL with 2PTs

2.3.4 Current Input Wiring

3CT

The 3CT current wiring configuration can be used when either 3CTs are connected (as shown in Fig.2-16) or 2CTs are connected (as shown in Fig.2-17) to the system. In either case, there is current flowing through all three current terminals.

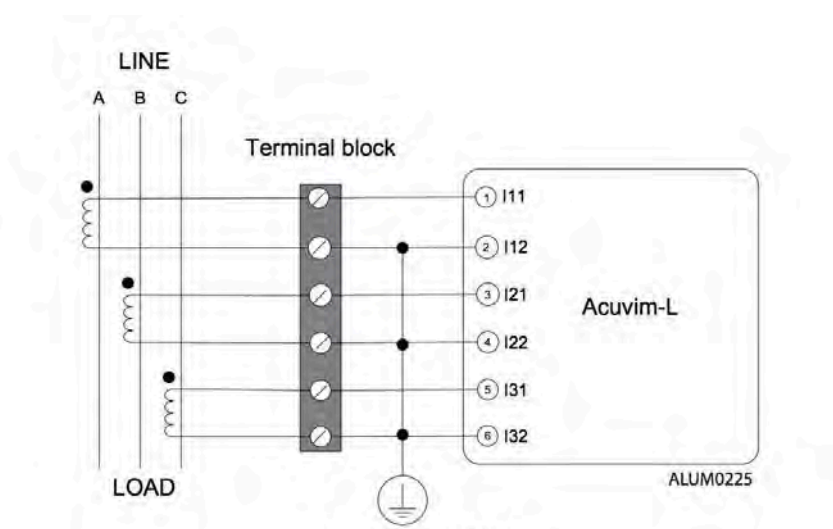

Fig.2-16 3CT-a

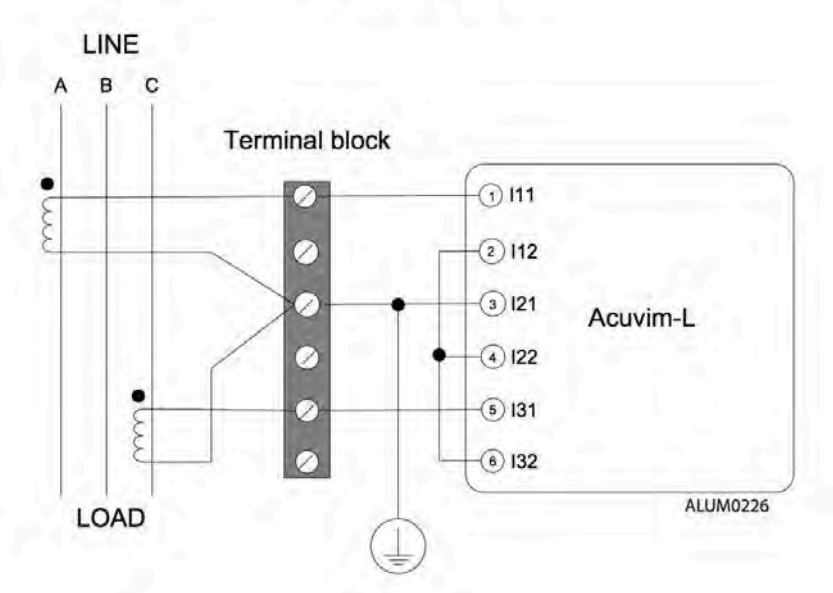

Fig.2-17 3CT-b

2CT

The difference between Fig.2-17 and Fig.2-18 is that no current flows through current input terminal I21 and I22. The I2 value is calculated from formula $i_1+i_2+i_3=0$. The current input mode of the meter should be set to 2CT .

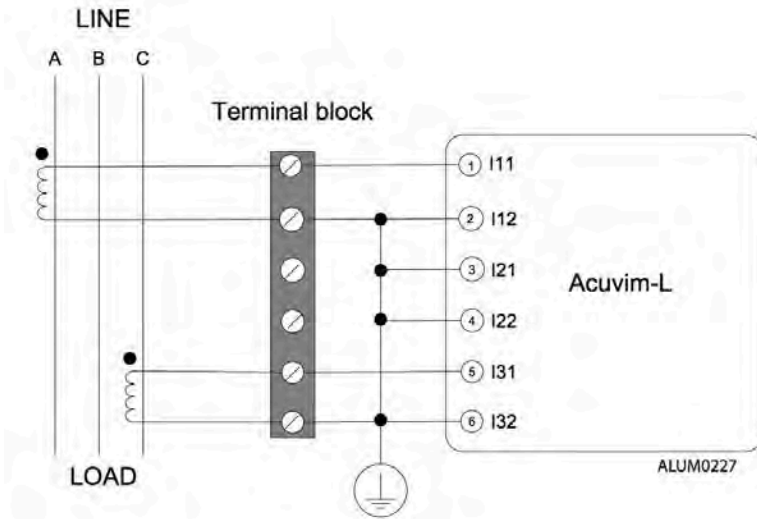

Fig.2-18 2CT

1CT

The current input mode of the meter should be set to 1CT

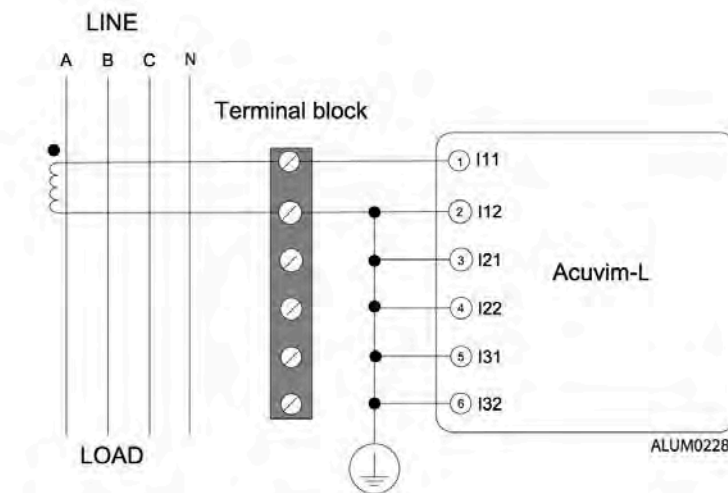

Fig.2-19 1CT

2.3.5 Frequently Used Wiring Method

In this section, most common voltage and current wiring connection combinations are put together into different diagrams. In order to display measurement readings correctly, please select the appropriate wiring diagram according your setup and application.

Note: Acuvim-L supports 3LN-3CT (Using the 3CT and a 2CT two wiring), 3LL-3CT, 2LL-3CT, 2LL-2CT, 1LL-2CT and 1LN-1CT.

1. 3LN, 3CT with 3 CTs (Wiring mode: 3LN, 3CT)

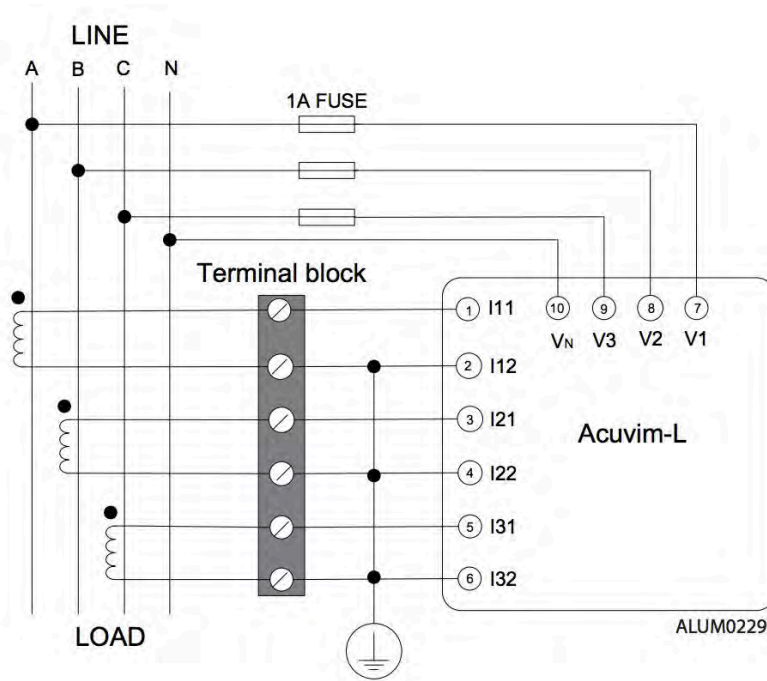

Fig.2-20 3LN, 3CT with 3CTs

2. 3LN, 3CT with 2 CTs (Wiring mode: 3LN,3CT)

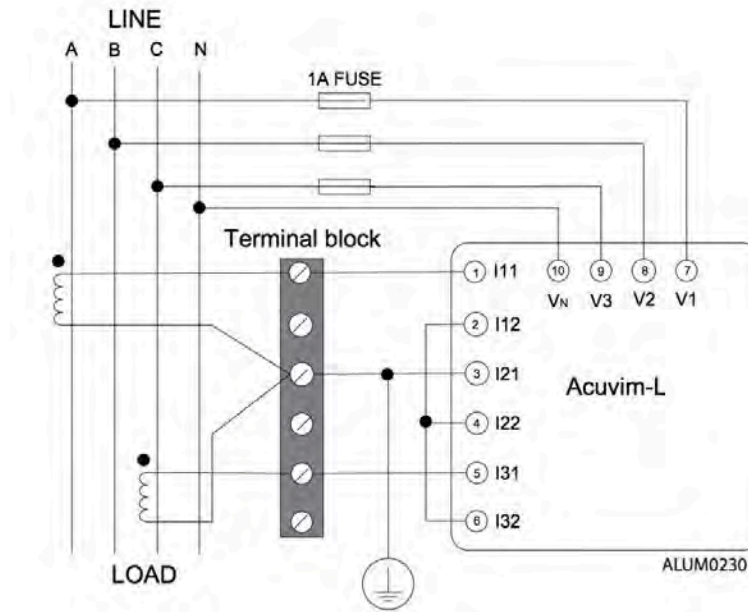

Fig.2-21 3LN, 3CT with 2CTs

3. 3LL,3CT (Wiring mode:3LL,3CT)

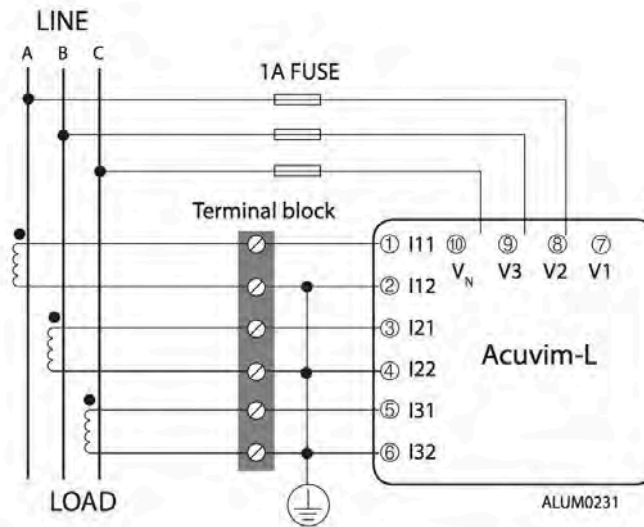

Fig.2-22 3LL, 3CT

4. 2LL, 3CT (Wiring mode: 2LL, 3CT)

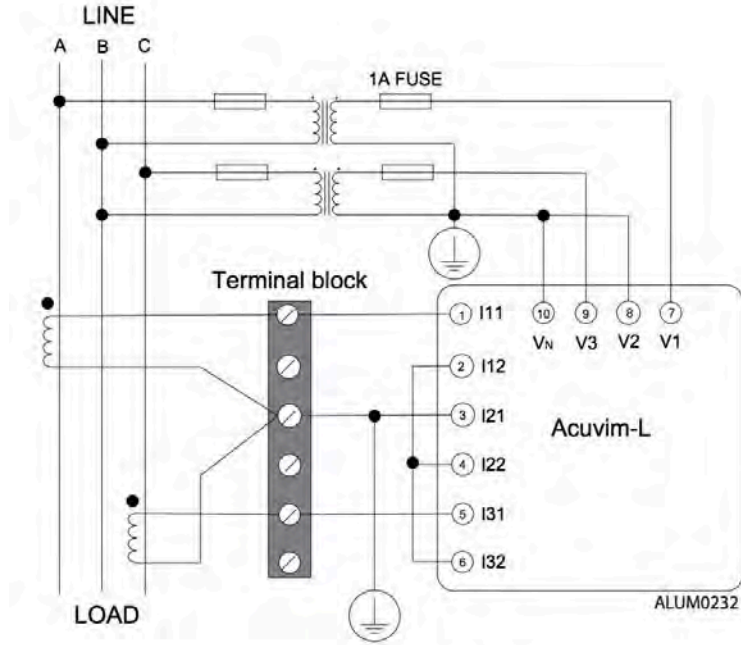

Fig.2-23 2LL, 3CT

5. 2LL, 2CT (Wiring mode: 2LL, 2CT)

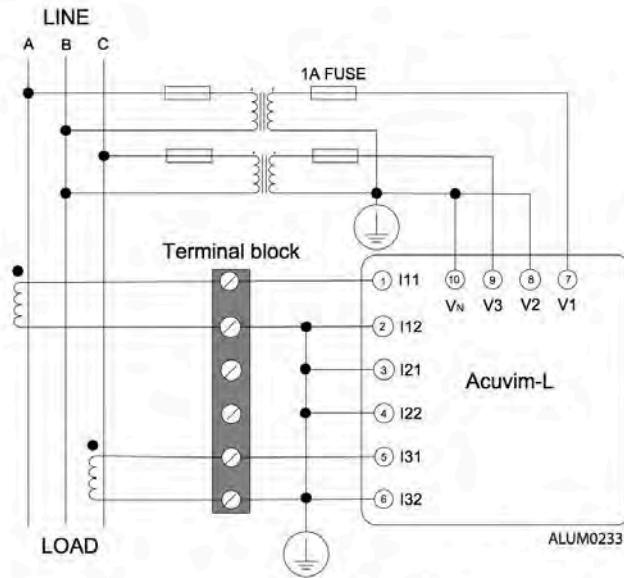

Fig.2-24 2LL, 2CT

6. 1LL, 2CT (Wiring mode setting 1LL, 2CT)

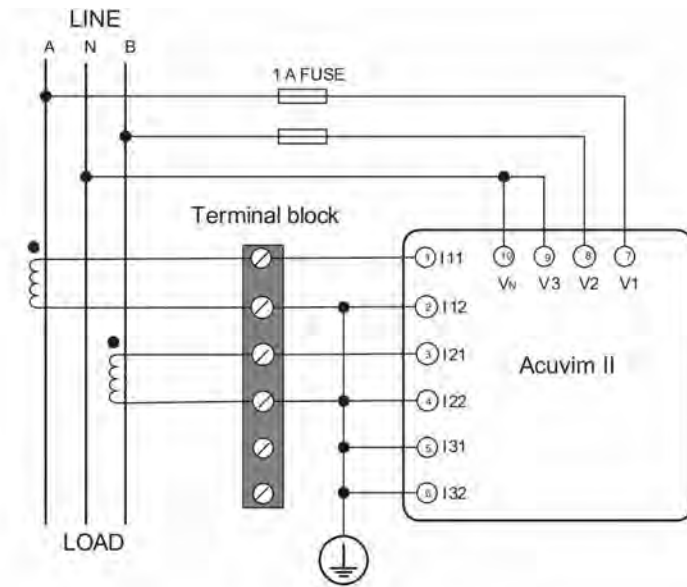

Fig 2-21 Single phase 3 Lines

7. 1LL, 2CT (Wiring mode setting 1LL, 2CT)

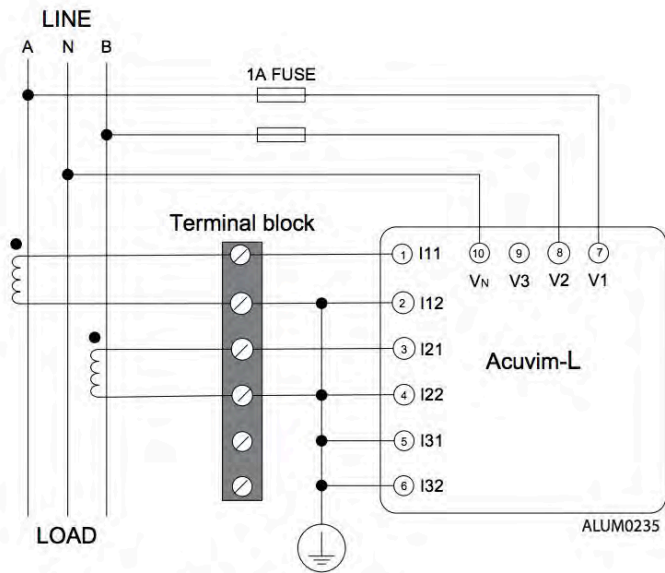

Fig.2-26 1LL,2CT

Note: For the 1LL, 2CT, A and B facies of the phase Angle is 180°.

2.3.6 Digital Output (DO)

There are two digital outputs for Acuvim-L. For the Acuvim-BL, the terminals of the digital output are DO1, DO2 and DOC . For the Acuvim-DL/EL, the terminals of the digital output respectively is DO11, DO12 and DO21, DO22. These two digital outputs can be used as energy pulse output or over/under limit alarming output.

Digital output circuit form is Photo-MOS. The simplified circuit is as below:

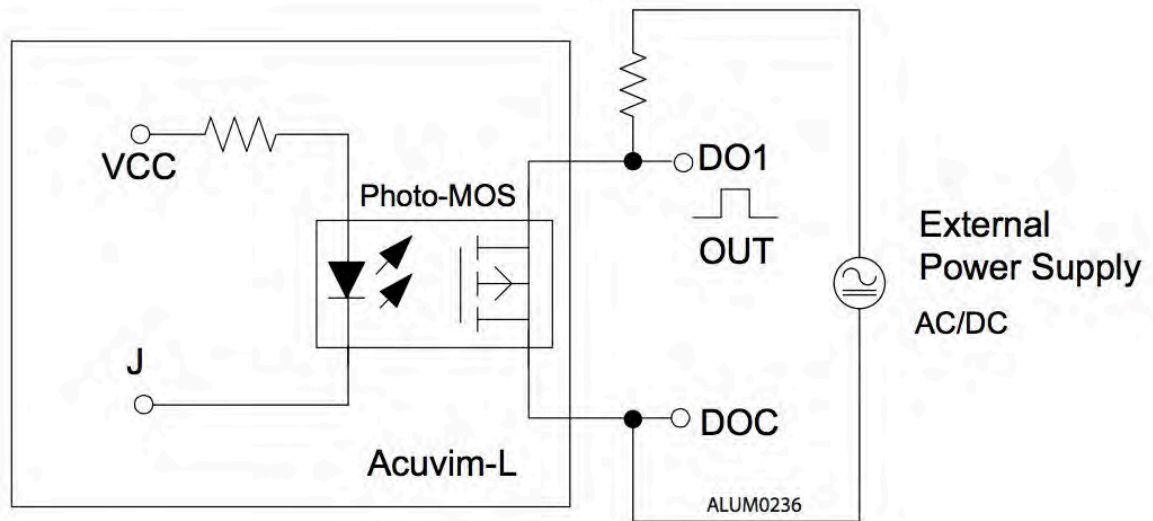

Fig.2-27 Digital output circuit

The max output voltage and current are 250Vac/300Vdc and 100mA. When the digital output is used as over/under limit alarming output, the upper and lower limit of the parameter, time interval and output port can be set from the meter front.

2.3.7 Digital Input (DI)

There are 4 dry-contact digital input in extension modules respectively. The digital input circuit can be used to detect remote signals, or be used as a counter of input pulses.

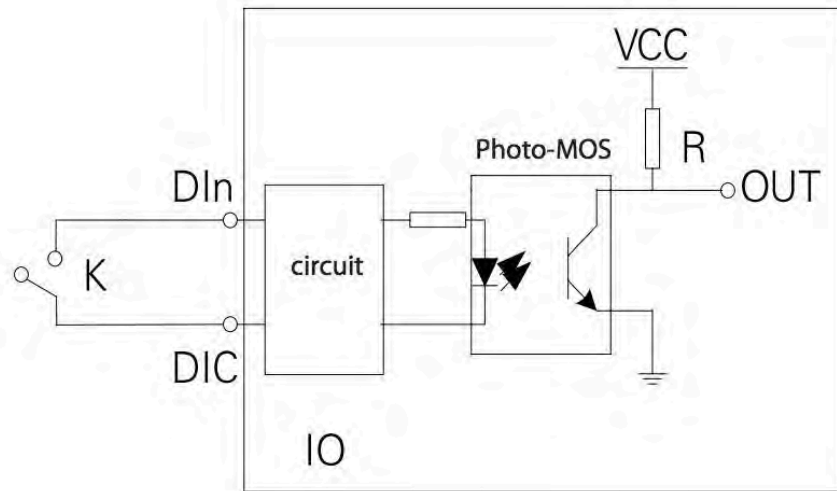

Fig.2-28 DI input circuit diagram

The circuit drawing of digital input is simplified as fig.2-28. When K is switched off, OUT is in high state. When K is switched on, OUT is in low state. The wire of digital input should be chosen between AWG22~16 or 0.5~1.3mm².

2.3.8 Communication

Acuvim-L series meter uses RS485 serial communication and the ModbusRTU protocol. The terminals of communication are A, B, and S (14, 15 and 16). A is differential signal +, B is differential signal - and S is connected to the shield of twisted pair cable. Up to 32 devices can be connected on a RS485 bus. Use good quality shielded twisted pair cable, AWG22 (0.5mm²) or larger. The overall length of the RS485 cable connecting all devices can not exceed 1200m (4000ft). Acuvim-L series meter can be used as a slave device of a master device such as PC, PLC, Data Collector and RTU.

If the master does not have RS485 communication port, a converter (such as a RS232/RS485 or a USB/RS485 converter) will be required. Typical RS485 network topologies include line, circle and star (wye).

Data transfer format is start bit + 8 data bits + parity + stop bit. NON1, NON2, odd and EVEN could be selected in the mode of parity. NON1 represents non-parity, single stop bit; NON2 represents non-parity, double stop bit; odd represents odd parity, single stop bit; EVEN represents EVEN-parity, single stop bit.

All meter has been standardized. In order to improve the quality of communications, now offers the following Suggestions:

The shield of the RS485 cable must be connected to the ground at one end only. Every A(+) should be connected to A(+), B(-) to B(-), or it will influence the network, even damage the communication interface.

“T” type connection topology should be avoided. This means no new branches except from the starting point.

Keep communication cables away as much as possible from sources of electrical noise. When several devices are connected (daisy chain) to the same long communication line, an anti signal reflecting resistor (typical value 120Ω- 300Ω/ 0.25W) is often used at the end of the circuit (the last meter of the chain) if the communication quality is distorted.

Use RS232/RS485 or USB/RS485 converter with optical isolated output and surge protection.

Acuvim-L Series Power Meter

Chapter 3: Meter Operation and Parameter Setting

3.1 Display Panel and Keys

3.2 Metering Data

3.3 Statistics Display

3.4 System Parameter Setting

3.5 DO Parameter Setting and Expansion Module Setting

3.6 Ethernet Network Module Settings

3.7 DI Status Display

3.8 TOU Energy and Maximum Demand Display

3.9 Measurement Methods and Parameters Definitions

Chapter 3: Meter Display and Parameter Settings

Operational details of the meter will be described in this chapter. This includes viewing real-time metering data and setting parameters using different key combination.

3.1 Display Panel and Keys

The front of the Acuvim-L series meter consists of an LCD screen and four control keys. All display segments are shown as Fig.3-1 below:

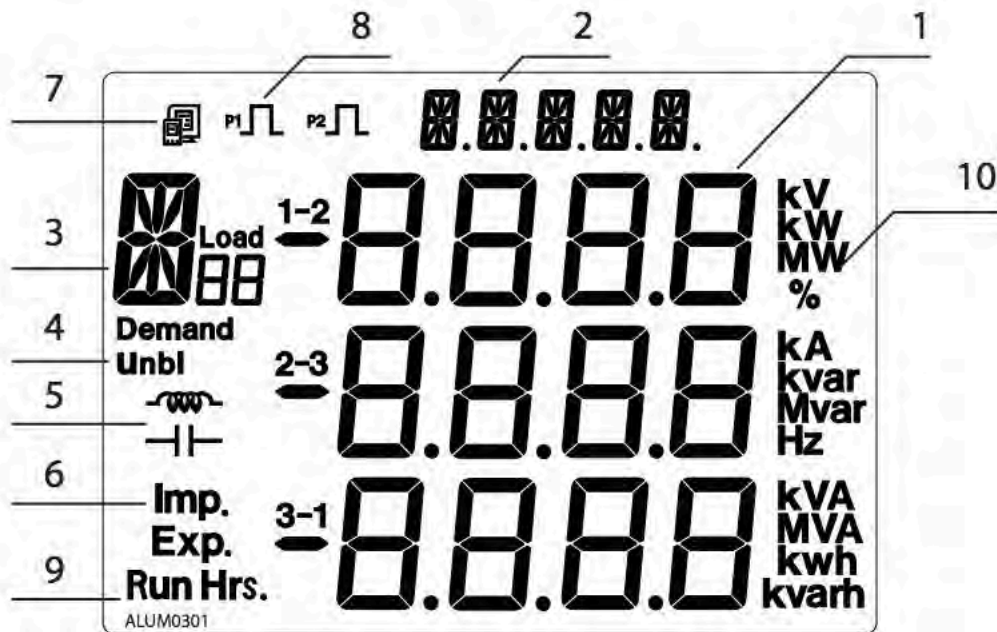
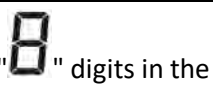









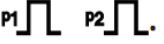



Fig.3-1 All display segments

SN	Display	Description
1	Three lines of "8" digits in the metering area 	Display metering data Voltage, current, power, power factor, THD, frequency, demand, unbalance factor, max, min etc.
2	Status display area One line of "8" digits at the top of display panel 	Display current status Meter: metering status; Max: maximum value; Min: minimum value; THD: display Har: display individual harmonic for voltage and current.
3	Item icon 	Item icon U: voltage; I: current, P: active power; q: reactive power; PF: power factor; when displaying harmonic content, the little "8" digits show the harmonic order.
4	3-phase unbalance Unbl 	Unbalance icon
5	Load nature  	 : inductive load;  : capacitive load.
6	Energy Icon Imp. Exp. 	Imp: import energy; exp: export energy
7	Communication icon 	No icon: no communication With icon: communication
8	Energy pulse output indicator 	No icon: no pulse output With icon: pulse output
9	Time icon Run Hrs. 	With icon: display running time
10	Units	Indicate data unit Voltage: V, kV, Current: kA, A, Power: kW and MW, Reactive Power: kvar and Mvar, Apparent Power: kVA and MVA, Frequency: Hz, Energy: kWh, Reactive Power: kvarh, Percentage: %

There are four dedicated keys on the front panel, labeled H, P, E and V/A from left to right. Use these four keys to read metering data and set the parameters.

Note: If the LCD backlight is off, press any key one time to bring the backlight on

3.2 Metering Data

Acuvim-L series meter displays the voltage metering screen (default screen) when first powered up. Different key combinations show different screen. Press “V/A” to show real-time metering data; press “E” to show energy parameters; press “P” to show power parameters; press “H” to show power quality information; press “H” and “E” together simultaneously to show max/min information, unbalance and individual harmonics.

Press “H” and “V/A” together simultaneously to show basic parameter setting. Press “P” and “V/A” together simultaneously to show DI Status. Press “E” and “V/A” together simultaneously to show TOU Energy.

Note: No harmonic contents will be displayed in Acuvim-EL and Acuvim-KL.

Press “V/A” to read voltage and current in the metering area. The screen will proceed to the next display as you press “V/A” each time. It will go back to the first screen if you press “V/A” at the last screen.

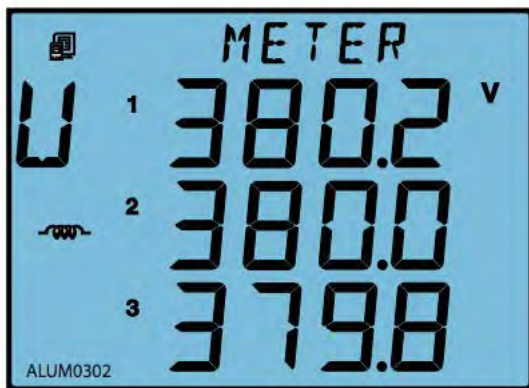

Fig.3-2 Three phase voltage

The 1st screen: Voltage for each phase: U1, U2 and U3. As shown in Fig.3-2, U1=380.2 V, U2=380.0 V, U3=379.8 V.

Load nature is inductive, and communication status is good.

Note: Since load nature and communication status belong to system information, the icons are displayed on every screen.

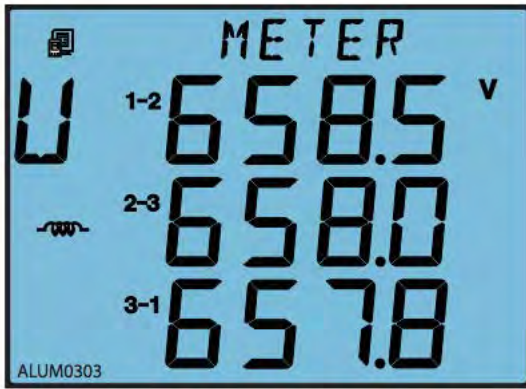

Fig.3-3 Three phase voltage

Press "V/A" to go to the next screen.

The 2nd screen: Line to line voltage: U12, U23 and U31. As shown in Fig.3-3, U12=658.5 V, U23=658.0 V, U31=657.8 V.

Press "V/A" to go to the next screen.

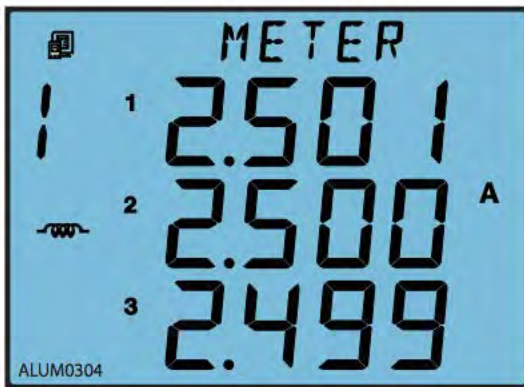

Fig.3-4 Three phase current

The 3rd screen: Current for each phase: I1, I2 and I3. As shown in Fig. 3-4, I1=2.501 A, I2=2.500 A, I3=2.499 A.

Press "V/A" to go to the next screen.

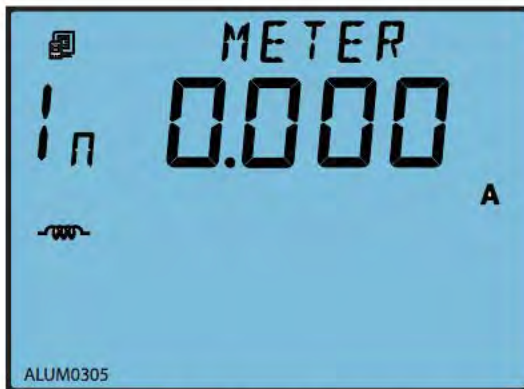

Fig.3-5 Neutral current

The 4th screen: Neutral current. As shown in Fig.3-5, In=0.000 A.

Press "V/A" to go to the next screen.

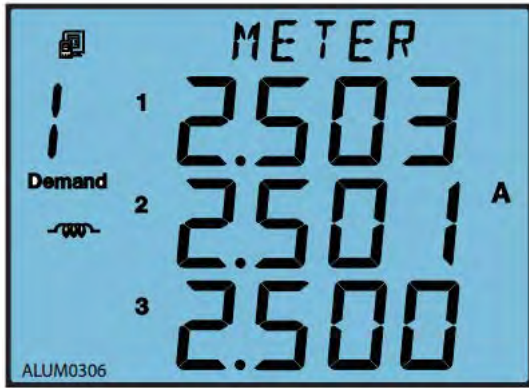

Fig.3-6 Demand current

The 5th screen: Current demand of each phase.

As shown in Fig.3-6, Dmd_I1=2.503 A, Dmd_I2=2.501 A, Dmd_I3=2.500 A.

Press “V/A” to go back to the 1st screen.

Note: For Acuvim-KL, only the current page is displayed. When the wiring mode is set to 3LL-3CT,2LL-3CT or 2LL-2CT, it will not display phase voltage and neutral current, there is no the 1st and 4th screen. When the wiring mode is set to 1LL2CT, it only shows Uab of 2nd screen, Ia and Ib of 3rd screen. When the wiring is 1LL-1CT, it only shows Ua of 1st screen and Ia of 3rd screen, not display line voltage and neutral current, there is no the 2nd and 4th screen.

Press “P” to display power related parameters.

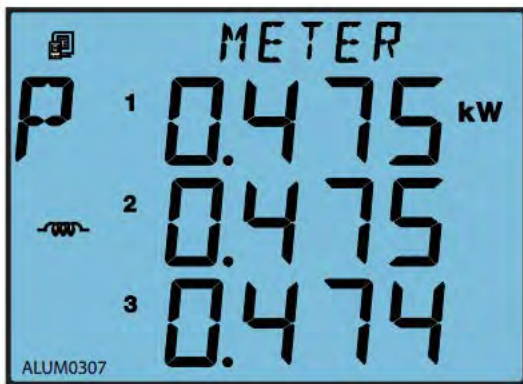

Fig.3-7 Three phase power

The 5th screen: Current demand of each phase.

As shown in Fig.3-6, Dmd_I1=2.503 A, Dmd_I2=2.501 A, Dmd_I3=2.500 A.

Press “V/A” to go back to the 1st screen.

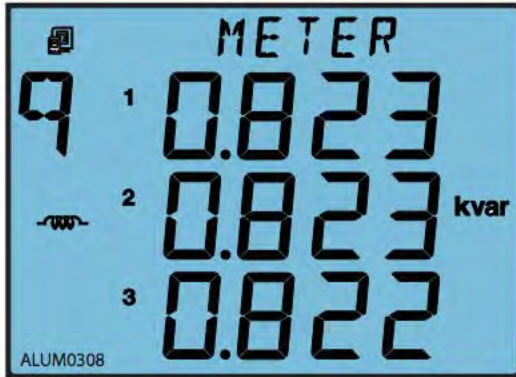

Fig.3-8 Three phase reactive power

The 2nd screen: Reactive power of each phase.

As shown in Fig.3-8, $Q_1=0.823$ kvar, $Q_2=0.823$ kvar, $Q_3=0.822$ kvar.

Press “P”, go to the next screen.
Go back to the 1st screen.

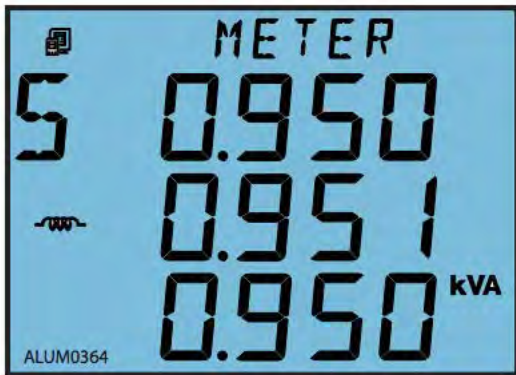

Fig.3-9 Three phase apparent power

The 3rd screen: Apparent power of each phase.

As shown in Fig.3-9, $S_1=0.950$ kVA, $S_2=0.951$ kVA, $S_3=0.950$ kVA.

Press “P” to go to the next screen.

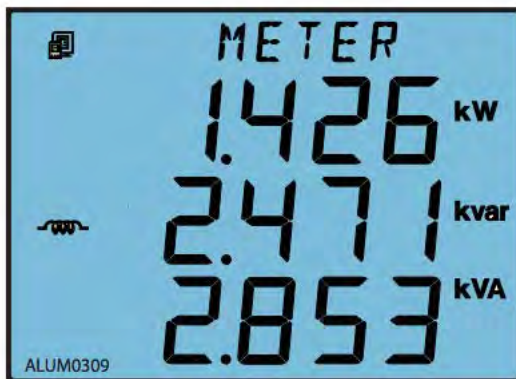

Fig.3-10 System total power

The 4th screen: System total power, reactive power and apparent power.

As shown in Fig.3-10, $P_{sum}=1.426$ kW, $Q_{sum}=2.471$ kvar, $S_{sum}=2.853$ kVA.

Press “P” to go to the next screen.

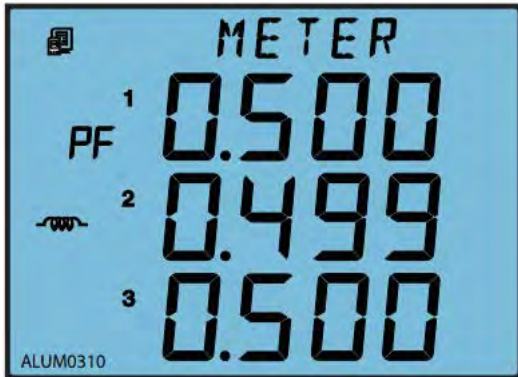

Fig.3-11 Three phase power factor

The 5th screen: Power factor of each phase: PF1,PF2, PF3.

As shown in Fig.3-11, PF1=0.500, PF2=0.499, PF3=0.500.

Press “P” to go to the next screen.

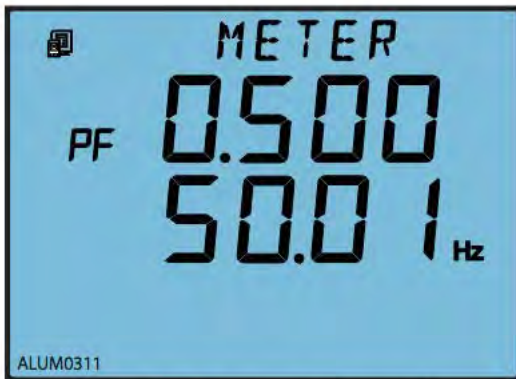

Fig.3-12 Power factor and frequency

The 6th screen: System average power factor PF and system frequency F.

As shown in Fig.3-12, PF=0.500, F=50.01 Hz.

Press “P” to go to the next screen.

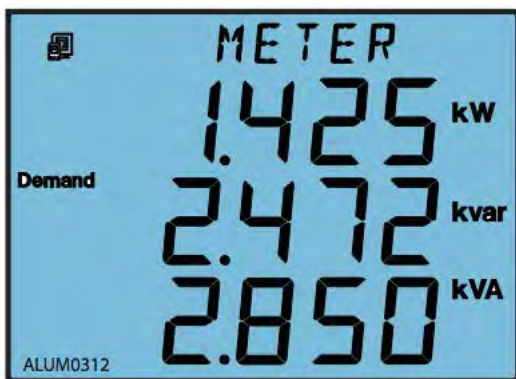

Fig.3-13 System power demand

The 7th screen: System power demand Dmd_P, reactive power demand Dmd_Q and apparent power demand Dmd_S.

As shown in Fig.3-13, Dmd_P=1.425 kW, Dmd_Q=2.472 kvar, Dmd_S = 2.850 kVA.

Press “P” to go to the next screen.

Note: For Acuvim-KL, only display system power, When the wiring is set to 3LL-3CT, 2LL-3CT and 2LL-2CT, it will not show single-phase active power of 1st, two single-phase reactive power of 2nd, single-phase apparent power of 3rd and single-phase power factor of 5th.

For other series meters, if the wiring is set to 2LL, or 3LL, there is no single-phase power and single-phase power factor displayed, press P to switch between screens only 4,6,7.

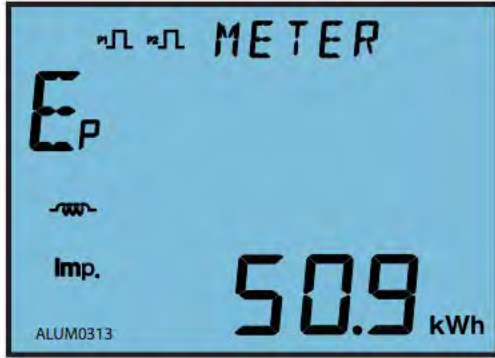

Fig.3-14 Import energy

The 1st screen: Import energy

As shown in Fig. 3-14, Ep_imp=50.9 kWh.

Press “E”, go to the next screen.

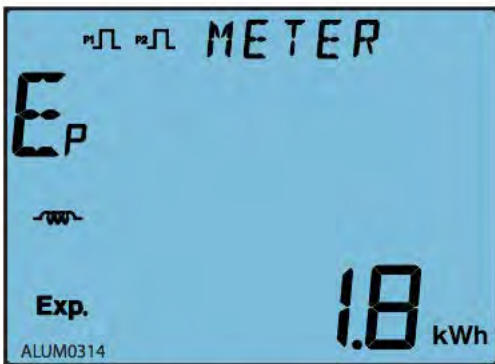

Fig.3-15 Export energy

The 2nd screen: Export energy.

As shown in Fig. 3-15, Ep_exp=1.8 kWh.

Press “E”, go to the next screen.

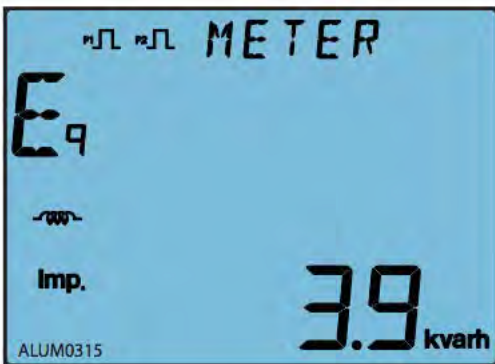

Fig.3-16 Import reactive energy

The 3rd screen: Inductive (import) reactive energy.

As shown in Fig. 3-16, Eq_imp=3.9 kvarh.

Press “E” to go to the next screen.

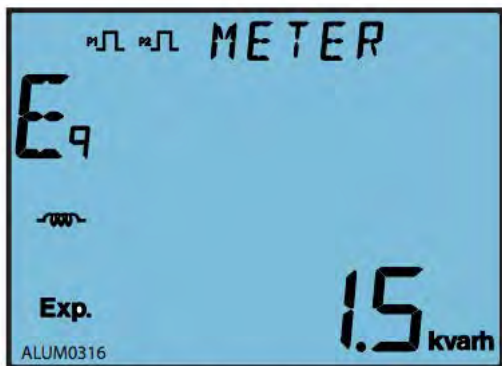

Fig.3-17 Export reactive energy

The 4th screen: Capacitive (export) reactive energy.

As shown in Fig. 3-17, Eq_exp=1.5 kvarh.

Press “E” to go to the next screen.

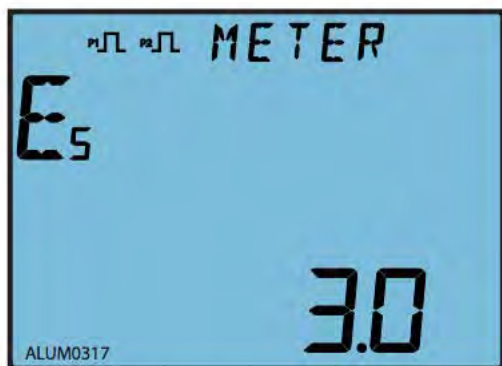

Fig.3-18 Apparent energy

The 5th screen: Apparent energy.

As shown in Fig.3-18, Es = 3.0kVAh.

Press “E” to go to the next screen.

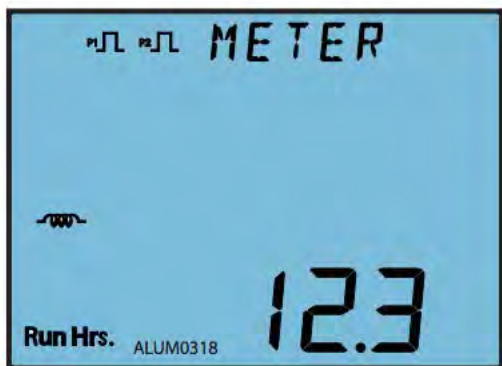

Fig.3-19 Run hours

The 6th screen: Run hours.

As shown in Fig.3-19, Run_Hour=12.3 hours.

Press “E” to go to the next screen.

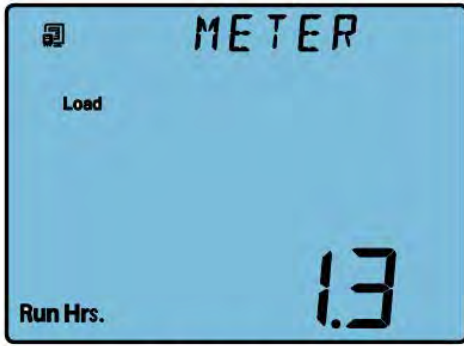

Fig.3-20 Load Run hours

The 7th screen: Load Run hours.
As shown in Fig.3-20, Load Run hour = 1.3 hours.

Press “E” to go to the next screen.

Note: This screen only applies to Acuvim-DL, EL and KL.

Note: In real-time metering mode, Acuvim-AL, Acuvim-BL, Acuvim-CL, Acuvim-DL and Acuvim-EL display voltage and current THD when “H” is pressed.

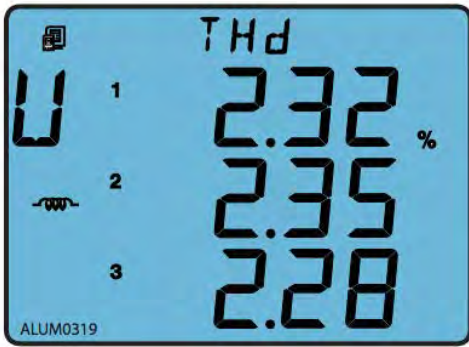

Fig.3-21 Phase voltage THD

The 1st screen: Voltage THD.

When voltage wiring mode is set to 3LN, display shows phase voltage THD: THD_U1, THD_U2, THD_U3.

As shown in Fig. 3-21, THD_U1=2.32%, THD_U2=2.35%, THD_U3=2.28%.

When voltage wiring mode is set to 2LL or 3LL, display shows line to line voltage THD: THD_U12, THD_U23, THD_U31.

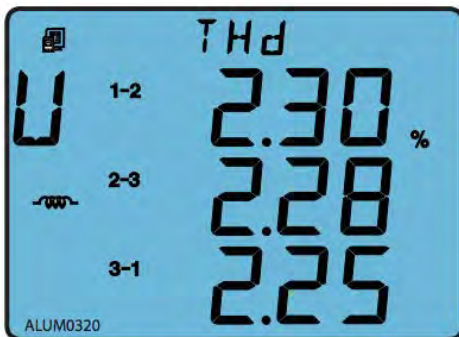

Fig.3-22 Line to line voltage THD

As shown in Fig.3-22, THD_U12=2.30%, THD_U23=2.28%, THD_U31=2.25%.

When voltage wiring mode is set 1LN, display only shows phase voltage THD: THD-U1. When voltage wiring mode is set 1LL, display only shows phase voltage THD: THD-U1 and THD-U2.

Press “H” to go to the next screen.

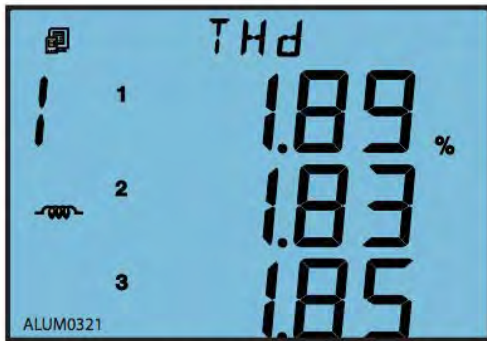

Fig.3-23 Current THD

The 2nd screen: Phase current THD: THD_I1, THD_I2, THD_I3.

As shown in Fig 3-23, THD of three phase current, THD_I1=1.89%, THD_I2=1.83%, THD_I3=1.85%.

Press “H” key, go back to the 1st screen.

Note: When voltage wiring mode is set to 1LN, display only shows phase current THD: THD-I1. When voltage wiring mode is set to 1LL, display only shows phase current THD: THD-I1 and THD-I2.

3.3 Statistics Display

For Acuvim-AL,BL,CL,DL,EL Press “H” and “E” simultaneously to enter the statistic display mode. Maximum and minimum value for metering parameters are demand, voltage and current unbalance factor, and individual voltage and current harmonic. Press “H” and “E” simultaneously again to exit to the real-time metering mode.

Note: Acuvim-EL and Acuvim-KL will not show harmonic contents.

3.3.1 Display Max and Min of the voltage and current and Peak Demand of current. (AL, BL, CL, DL, EL)

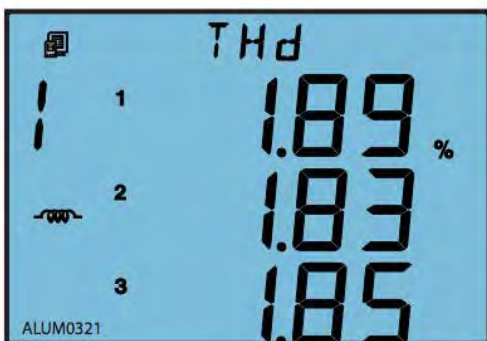

Fig.3-23 Current THD

Press “V/A” key under the statistics display mode to display the Min and Max value of voltage, current and current demand.

The 1st screen: Max value of phase voltage. The “Max” icon is shown on the top of screen.

As shown in Fig. 3-24, U1_MAX=380.3 V, U2_MAX=380.2 V, U3_MAX=380.5 V.



Fig.3-25 Min value of phase voltage

The 2nd screen: MIN value of phase voltage. The “MIN” icon shown on the top of screen.

As shown in Fig.3-25, U1_MIN=379.6 V, U2_MIN=379.8 V, U3_MIN=379.7 V.

Press “V/A” to go to the next screen.

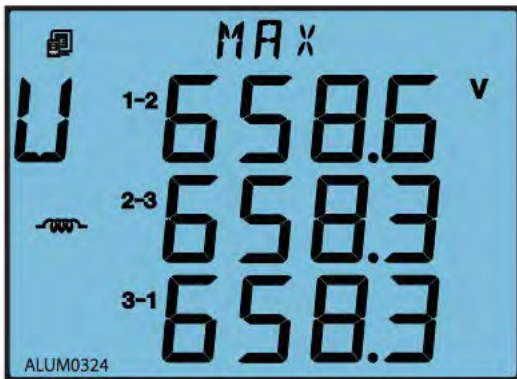

Fig.3-26 Max value of line to line voltage

The 3rd screen: Max value of line to line voltage.

As shown in Fig 3-26, U12_MAX=658.6 V, U23_MAX=658.3 V, U31_MAX=658.3 V.

Press “V/A” to go to the next screen.



Fig.3-27 Min value of line to line voltage

The 4th screen: MIN value of line to line voltage.

As shown in Fig.3-27, U12_MIN=657.8 V, U23_MIN=657.7 V, U31_MIN=657.6 V.

Press “V/A” to go to the next screen.

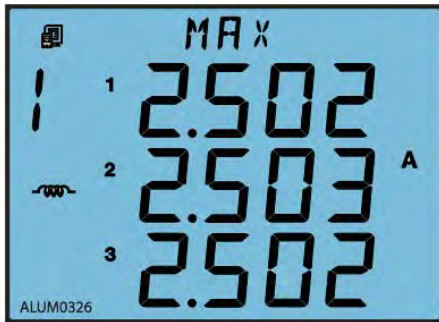

Fig.3-28 Max value of current

The 5th screen: MAX value of current.

As shown in Fig.3-28, I1_MAX=2.502 A , I2_MAX=2.503 A, I3_MAX=2.502 A .

Press “V/A” to go to the next screen.

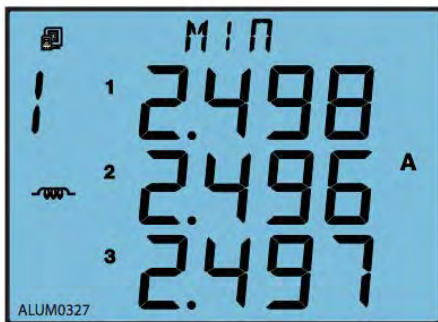

Fig.3-29 Min value of current

The 6th screen: MIN value of current.

As shown in Fig.3-29, I1_MIN=2.498 A, I2_MIN=2.496 A, I3_MIN=2.497 A.

Press “V/A” to go to the next screen.

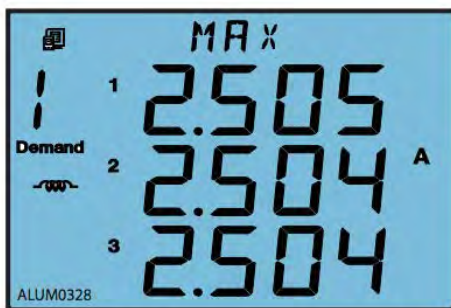

Fig.3-30 Peak current demand

The 7th screen: Peak current demand.

As shown in Fig 3-30, I1_Demand_MAX=2.505

A, I2_Demand_MAX=2.504 A, I3_Demand_MAX=2.504 A.

When voltage wiring mode is set to 1LN, display only shows first line of 1st, 2nd, 5th, 6th and 7th screen. When voltage wiring mode is set to 1LL, display only shows first and second line of 1st, 2nd, 5th, 6th and 7th screen, and first line of 3rd and 4th. When voltage wiring mode is set to 2LL or 3LL, display doesn't show the 1st and 2nd screen.

Press “V/A” to go back to the first screen.

3.3.2 Display the Max value of power and reactive power demand.

Press “P” under the statistics display mode to display the peak value for power, reactive power and apparent power demand.

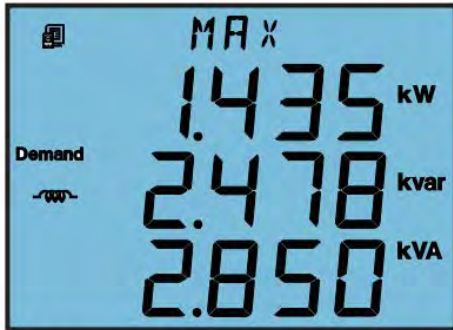

The 7th screen: Peak current demand. As shown in Fig 3-30, I1_Demand_MAX=2.505 A, I2_Demand_MAX=2.504 A, I3_Demand_MAX=2.504 A.

Fig.3-31 maximum system power demand

3.3.3 Display power quality parameter (AL, BL, CL, DL, EL)

When press “H” under statistic display mode, will display voltage and current unbalance factor as well as individual voltage and current harmonic content.



The 1st screen: Unbalance factor for voltage and current.

As shown in Fig.3-32, voltage unbalance factor=0.3%, current unbalance factor=0.5%.

Press “H” to go to the next screen.

Fig.3-32 Unbalance factor for voltage and current

Press “H” key to display voltage and current harmonic content. The HAR icon will be shown on the top of the screen. The sequence will roll starting from the 2nd harmonic of voltage to the 15th harmonic of current as you press “H” each time. The following shows the display for phase voltage, line to line voltage and current harmonic contents.

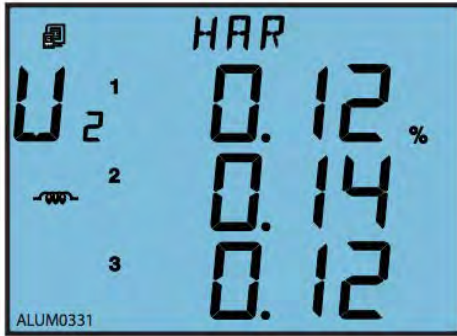

Fig.3-33 2nd harmonic content of phase voltage

The 2nd screen: 2nd harmonic content of voltage.

As shown in Fig.3-33, U₁_Hr2=0.12%, U₂_Hr2=0.14%, U₃_Hr2=0.12%.

Press H to scroll through the 3rd to the 31th phase voltage harmonic content

Note: When voltage wiring of the meter is set to 2LL or 3LL, line to line voltage harmonic contents will be display instead (as shown in Fig. 3-34).



Fig.3-34 2nd harmonic content of line to line voltage

The 2nd screen: 2nd harmonic content of line to line voltage.

As shown in Fig.3-34, U₁₂_Hr2=0.12%, U₂₃_Hr2=0.14%, U₃₁_Hr2=0.12%.

Press H to scroll through the 3rd to the 31th line to line voltage harmonic content.

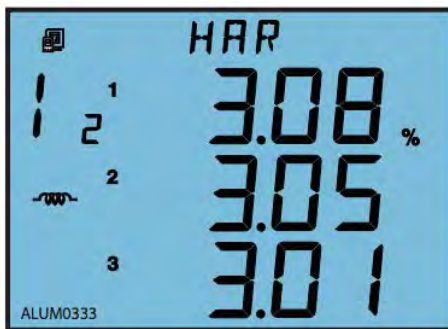

Fig.3-35 2nd harmonic content of current

The 33th screen: 2nd harmonic content of current.

As shown in Fig.3-35, I₁_Hr2=3.08%, I₂_Hr2=3.05%, I₃_Hr2=3.01%.

Press “H” key to scroll through the 3rd to the 31th current harmonic content.

In the statistic mode, press “H” and “E” simultaneously to exit this mode.

Note: When voltage wiring mode is set to 1LL, the screen only shows the first line and the second line; when set to 1LN, this screen only displays the first line.

3.4 System Parameter Setting

Press “H” and “V/A” simultaneously in the metering data display mode to enter the system parameter setting mode. All the settings can be done through the keys on the meter front panel.

Press “H” to move the flashing cursor to the right, press “P” to increase the number by 1 once a time, press “E” to decrease the number by 1 once a time, press “V/A” to accept the change and move to the next screen. Press “H” and “V/A” simultaneously to exit system parameter setting mode and return to real-time metering mode.

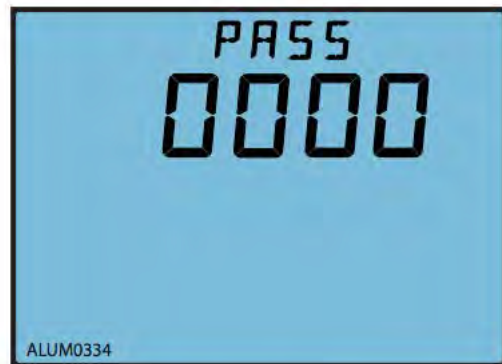
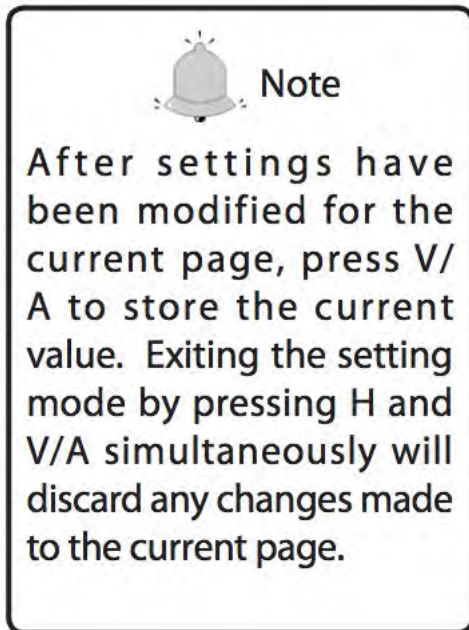

Fig.3-36 Password input page

System parameter setting mode is password protected, a four digit password (select from 0000 to 9999) is required every time before accessing the system parameter settings. The default password is 0000. After entering the password, press “V/A” to accept the password and proceed. The meter will return to the real-time metering mode if a wrong password is entered.



Fig.3-37 Communication address setting

The 1st screen: Communication Address setting.

The address can be any integer between 1 - 247. As shown in Fig.3-37, the communication address is 1.

To change the address, press “H” to move the cursor, press “P” to increase value by 1, press “E” to decrease value by 1. Press “V/A” to store the current address and go to the next setting screen. Press “V/A” to proceed to the next screen if there is no need to change the address.

Note: Meters cannot have the same communication address on the same RS485 communication line according to the Modbus-RTU protocol.

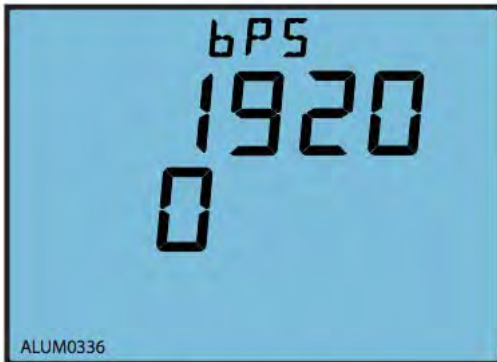

Fig.3-38 Baud rate setting

The 2nd screen: Baud rate setting.

The asynchronous communication setting of Acuvim-L is 8-bit, parity, 1 start bit and 1 or 2 stop bits. Baud rate can be set as follows: 1200, 2400, 4800, 9600, 19200, 38400, 57600. Press “P” or “E” to select a suitable baud rate. Press “V/A” to accept the change and proceed to the next screen. Same baud rate should be used for all meter connecting on the same communication line.



Fig.3-39 communication check setting

The 3rd screen: communication check setting. communication check could be one of four settings: non1, non2, odd, EVEN. As shown in Fig.3-39: communication check is set to non1.

Press “P” or “E” to select a communication check mode, press “V/A” to accept the change and processed to the next page.

Note: The page is only shown in Acuvim-EL and KL. “non1” represents non-parity, single stop bit; “non2” represents non-parity, double stop bit; “odd” represents odd-parity, single stop-bit; “EVEN” represents even parity, single stop bit. By default, it is set as “EVEN”.

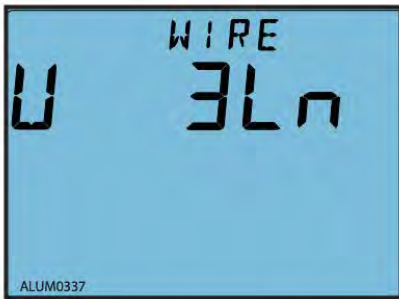

Fig.3-40 Voltage input wiring setting

The 4th screen: Voltage input wiring setting. Voltage input could be one of five setting: 3LN, 3LL, 2LL, 1LL, 1LN.

As shown in Fig.3-40: voltage input mode is set to 3LN.

Press “P” or “E” to select a wiring mode, press “V/A” to accept the change and proceed to the next page.



Fig.3-41 Current input wiring setting

The 5th screen: Current input wiring setting.

Current wiring mode can be one of the three settings: 3CT, 2CT, 1CT. As shown in Fig.3-41, current input mode is set to 3CT

Press “P” or “E” to select a wiring mode, press “V/A” to accept the change and proceed to the next page.

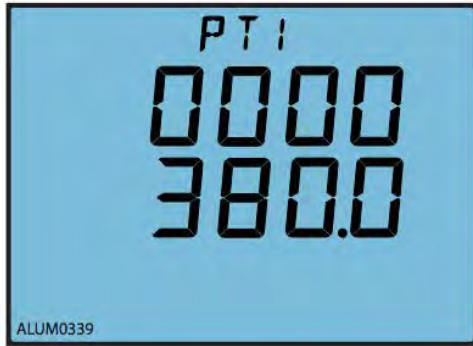

Fig.3-42 PT primary side ratio setting

The 6th screen: PT primary side ratio setting. PT1 ratio can be set from 50.0 to 1,000,000.0 (unit in V)

As shown in Fig.3-42, PT1=380.0V.

To change PT1 value, press “H” to move the cursor, press “P” to increase value by 1, press “E” to decrease value by 1. Press “V/A” to store the current value and proceed to the next screen.

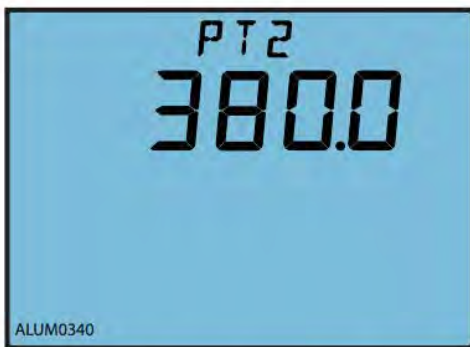

Fig.3-43 PT secondary side ratio setting

The 7th screen: PT secondary side ratio setting.

PT2 ratio can be set from 50.0 to 400.0 (unit in V).

As shown in Fig.3-43, PT2=380.0V.

To change PT2 value, press “H” to move the cursor, press “P” to increase value by 1, press “E” to decrease value by 1. Press “V/A” to store the current value and proceed to the next screen.

Note: If no PT is installed at the voltage input, PT1 and PT2 should be the same and equal to the input rated voltage.

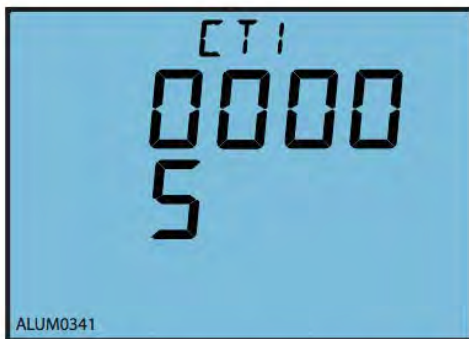

Fig.3-44 CT primary side ratio setting

The 8th screen: CT primary side ratio setting.

CT1 ratio can be set from 5 to 50000 (unit in A). For a 1A option meter, CT1 can be set from 1 to 50000 (unit in A).

As shown in Fig.3-44, CT1=5A.

To change CT1 value, press “H” to move the cursor, press “P” to increase value by 1, press “E” to decrease value by 1. Press “V/A” to store the current value and proceed to the next screen.

Note: CT1 has two-digit lines representing one figure. For example, if CT primary is 200, CT1 should be programmed as 0020 for the top line, and 0 for the bottom line, so that it is read as 200.

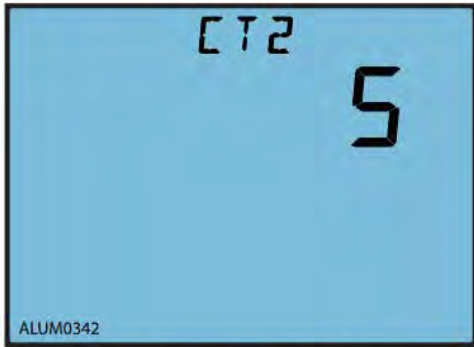

Fig.3-45 CT secondary side ratio setting

The 9th screen: CT secondary side ratio setting.

CT2 can be 1, 5 and 333; user can modify the CT2 as 1 or 5, if CT2=333mv, it cannot be modified.

As shown in Fig.3-45, CT1=5A, Press “V/A” to proceed to the next page.

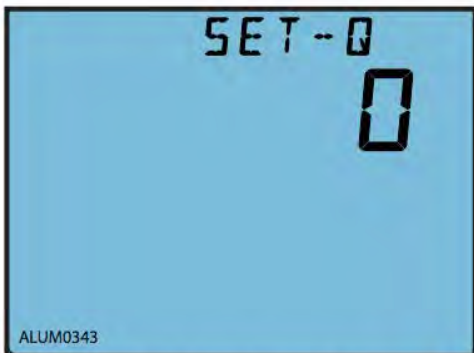

Fig.3-46 Definition of reactive power

The 10th screen: Definition of reactive power.

0: sinusoidal reactive power;
1: budeanu’s reactive power.

Please refer to Chapter 3.6 <<Measurement methods and parameter definitions>> for details.

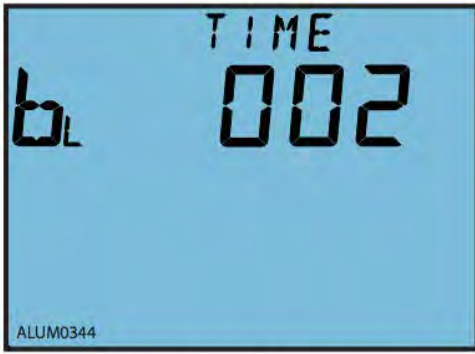

Fig.3-47 Backlight “ON” time setting

The 11th screen: Backlight “ON” time setting.

The “ON” time can be set from 0 to 120 minute.

The LCD screen backlight will always be “ON” if the setting value is 0. The backlight will turn “OFF” after inactive for a period of time if other value (from 1to 120) is set.

As shown in Fig.3-47, the setting time of the backlight is 2 minutes. The backlight will automatically turn “OFF” if no key activation within 2 minutes.

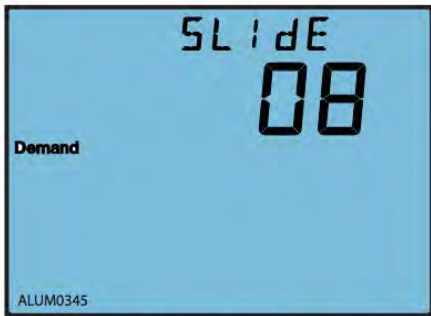

Fig.3-48 Sliding windows time for demand setting

The 12th screen: Sliding windows time for demand setting.

Sliding windows time of demand can be set from

1-30 minute. The window slides once per minute.

As shown in Fig.3-48, the sliding windows time is 8 minutes.

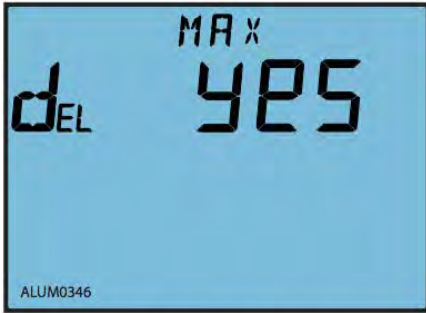

Fig.3-49 Clear Max and Min page setting

The 13th screen: Clear Max and Min page setting.

To clear Max and Min values do not mean writing 0 to all of the registers. Meter’s current metering values will be copied to the statistic registers instead and start a new statistic period.

Press “P” or “E” to select “YES” or “NO”:

“YES”: clear Max and Min;

“NO”: do not clear Max and Min.

Press “V/A” accept selection and proceed to the next page.

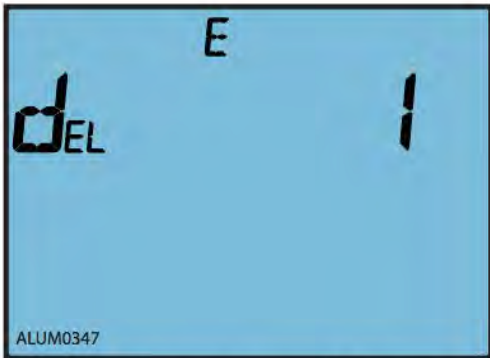

Fig.3-50 Clear energy enable setting

The 14th screen: Clear energy enable setting page.

This screen enables the energy reset function of the meter.

1: enable; 0: disable.

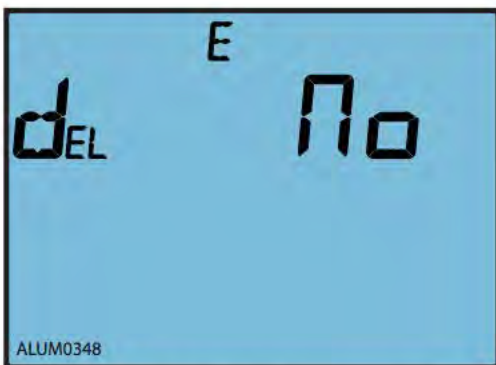

Fig.3-51 Acknowledgement to clear energy setting

The 15th screen: Acknowledgement to clear energy setting.

This screen appears only when the 14th screen is set as “enable”.

Press “E” or “P” to select “YES” or “NO”:

“YES”: clear energy;

“NO”: do not clear energy.

All energy parameters will be set to 0 when “YES” is selected. Press “V/A” to accept selection and proceed to the next page.

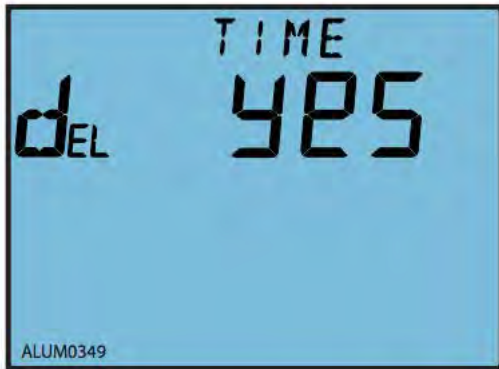

Fig.3-52 Clear running time setting

The 16th screen: Clear running time setting.

Press “P” or “E” to select “YES” or “NO”:
 “Yes”: clear running time;
 “No”: do not clear running time.

Running time will be set to 0 when “YES” is selected. Press “V/A” to accept selection and proceed to the next page.

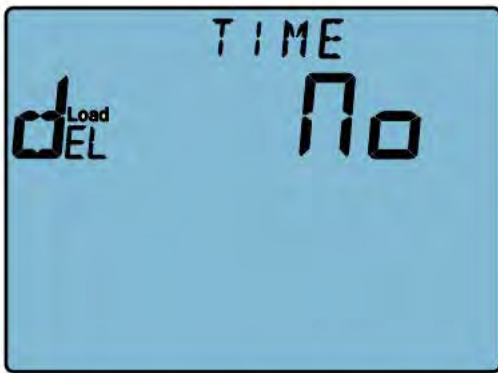

Fig.3-53 Clear load running time setting

The 17th screen: Clear load running time setting. the page would display. Press “P” or “E” to select “YES” or “NO”: “Yes”: clear running time. “No”: do not clear running time. Running time will be set to 0 when “YES” is selected. Press” V/A” to accept selection and proceed to next page.



Fig.3-54 VAR/PF setting

The 18th screen: VAR/PF setting. Press “P” or “E” to change VAR/PF setting. As shown in Fig.3-54 is IEC standard.

Note: The page would be show only in Acuvim-EL.

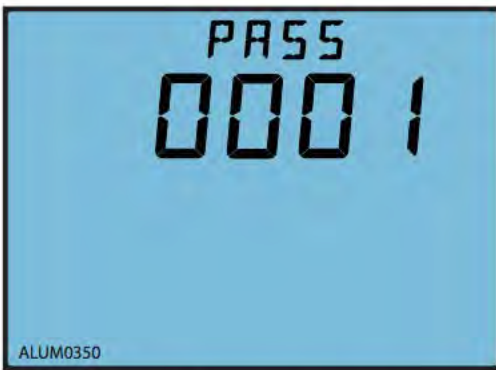

Fig.3-55 Password setting

The 19th screen: Password setting. This is the last screen in system parameter setting mode. The password can be changed in this page. It is important to remember the new password.

As shown in Fig.3-55, the password is 0001. Press “V/A” to store the new password and return to the first setting page. Press “H” and “V/A” together to exit the system setting mode after finishing all of the settings.

3.5 DO Parameter Setting and Expansion Module Setting (BL, DL, EL)

Acuvim-BL meter has two digital outputs. Each can operate as energy pulse output or alarm output. All DO parameters can be set from the meter front. To distinguish with system parameter setting mode, we call this setting mode as DO parameter setting mode.

Press “P” key and “E” key simultaneously under system parameter setting mode to enter DO parameter setting mode. Press “H” to move the flashing cursor to the right, press “P” to increase the number by 1 once a time, press “E” to decrease the number by 1 once a time, press “V/A” to accept the change and move to the next screen. Press “P” and “E” simultaneously to exit DO parameter setting mode and return to system parameter setting mode.

If the extend IO module could be added, it contains 2 DO, 4 DI and communication with Modbus-RTU standard. Press “P” key and “E” key simultaneously under system parameter setting mode to enter DO parameter setting and Extend IO communication setting mode, the operation about key is same as Acuvim-BL DO setting. The following steps show how to set DO items:

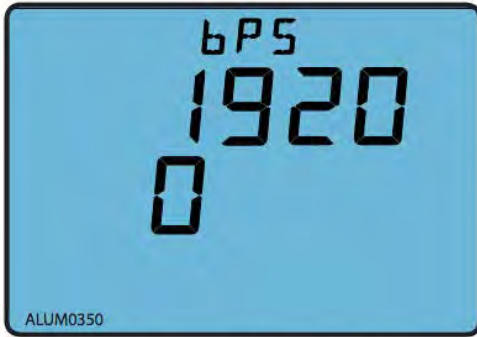

Fig.3-56 Extend IO baud rate setting

The 1st screen: Extend IO baud rate setting. Extend IO Baud rate can be set as follows: 1200, 2400, 4800, 9600, 19200, 38400, 57600. Press “P” or “E” to select a suitable baud rate. Press “V/A” to accept the change and proceed to the next screen. Same baud rate should be used for all meters connecting on the same communication line.

Note: The page would be shown only in AcuvimDL and Acuvim-EL.

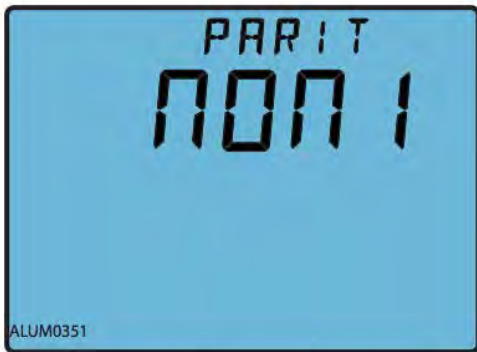

Fig.3-57 Extend IO communication check setting

The 2nd screen: Extend IO communication check setting. Extend IO communication check could be one of four settings: NON1, NON2, odd, EVEN. As shown in Fig.3-57: Extend IO communication check is set to NON1.

Press “P” or “E” to select a communication check mode, press “V/A” to accept the change and processed to the next page.

Note: The page would be shown only in AcuvimEL.

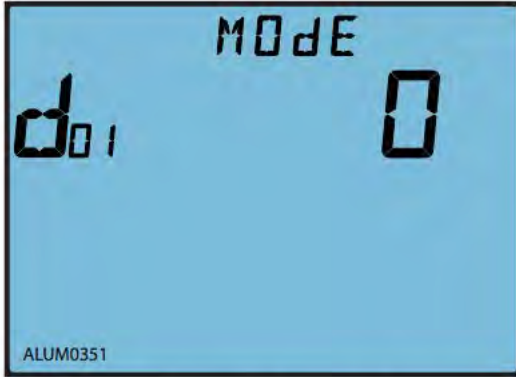

Fig.3-58 DO1 output mode setting

The 3th screen: DO1 output mode setting.

0: pulse output; 1: alarm output. As shown in Fig.3-58, DO1 is set as pulse output mode.

Press “V/A” to accept change and proceed to the next page.

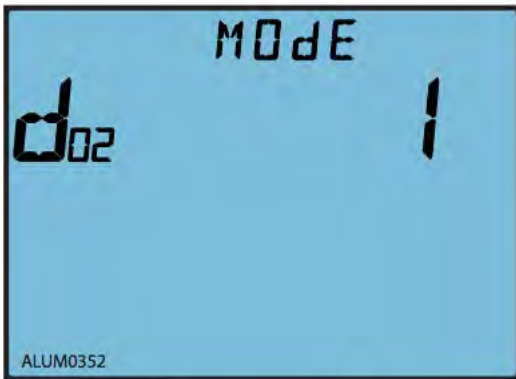

Fig.3-59 DO2 output mode setting

The 4th screen: DO2 output mode setting.

0: pulse output; 1: alarm output. As shown in Fig.3-59, DO2 is set as alarm output mode.

Press “V/A” to accept change and proceed to the next page

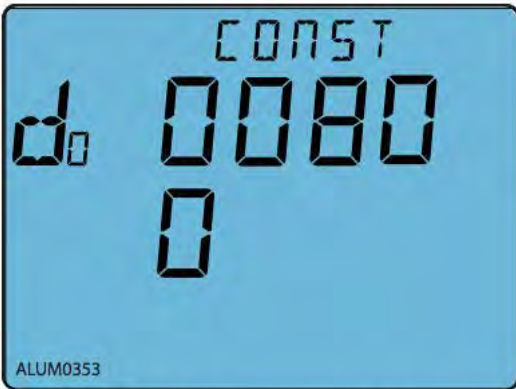

Fig.3-60 DO pulse constant rate setting

The 5th screen: DO pulse constant rate setting. Pulse constant can be set from any integer from 800 to 60000.

As shown in Fig.3-60, pulse constant is 800(meaning 800 pulse for every 1kWh or 1kvarh).

Press “V/A” to accept change and proceed to the next page

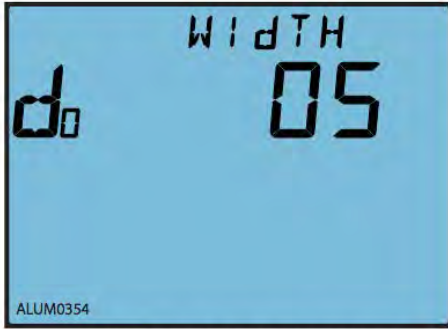

Fig.3-61 DO pulse width setting

The 6th screen: DO pulse width setting.

DO pulse width can be set from any integer from 1 to 50. Each unit stands for 20ms.

As shown in Fig.3-61, the pulse width is set to 5, that is $5 \times 20 = 100$ ms.

Press “V/A” to accept change and proceed to the next page.

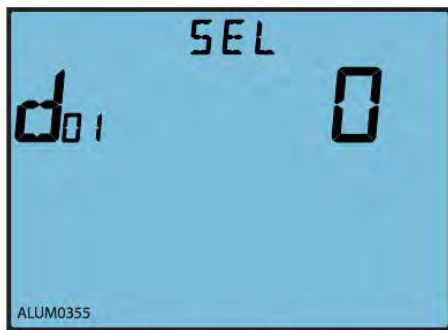

Fig.3-62 DO1 output items setting

The 7th screen: DO1 output item setting.

The DO1 output can be one of the following energy items shown in table below:

Press “V/A” to accept change and proceed to the next page.

Item value	0	1	2	3	4
Energy select	No output	Ep_imp	Ep_exp	Eq_imp	Eq_exp

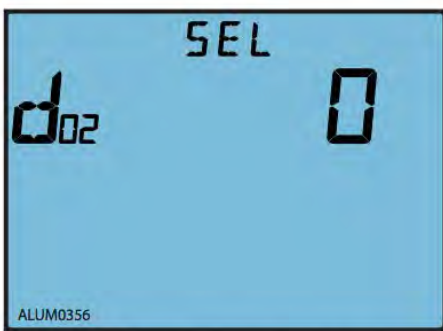

Fig.3-63 DO2 output item setting

The 8th screen: DO2 output item setting.

Same as DO1 output item setting, refer to the energy item selection table shown above.

DO1 and DO2 settings are independent of each other.

Press V/A key for acknowledgement and go to the next page.



Fig.3-64 DO delay time for alarm setting

The 9th screen: DO delay time for alarm setting.

If alarm condition lasts for over the pre-set time period, the alarm signal will be triggered. The delay time can be set from any integer from 0 to 255. Each unit stands for 300ms.

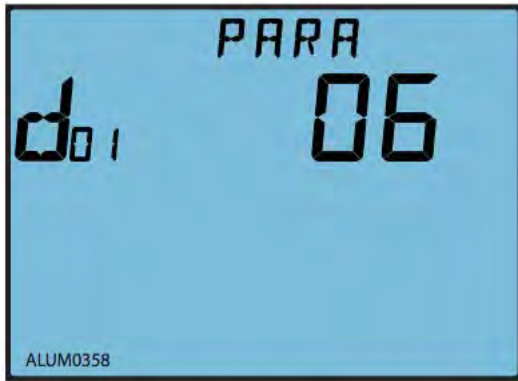

Fig.3-65 DO1 alarm output items setting

The 10th screen: DO1 alarm output item setting.

The DO1 alarm output can be one of the following energy items shown in table below:

As shown in Fig.3-65, DO1 alarm parameter is 06, tracking object is V31

Press "V/A" to accept change and proceed to the next page.

Var	0	1	2	3	4	5	6	7	8
Item	Hz	V1	V2	V3	V12	V23	V31	I1	I2
Var	9	10	11	12	13	14	15	16	17
Item	I3	In	P1	P2	P3	Psum	Q1	Q2	Q3
Var	18	19	20	21	22	23	24	25	26
Item	Qsum	Ssum	PF1	PF2	PF3	PFsum	U_unbl	I_unbl	Dmd_P
Var	27	28	29	30	31	32	33	34	
Item	Dmd_Q	Dmd_I1	Dmd_I2	Dmd_I3	S1	S2	Dmd_S		

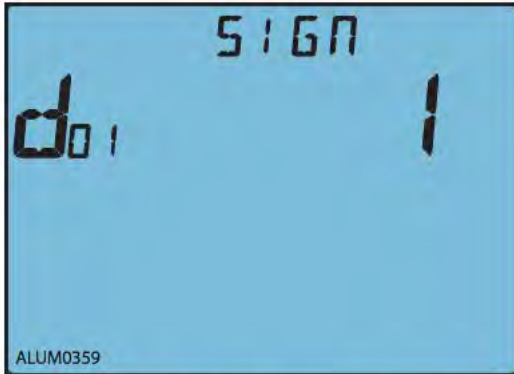

Fig.3-66 DO1 inequality sign setting

The 11th screen: DO1 inequality sign setting.

0: < (less than); 1: > (greater than)

As shown in Fig.3-66, the inequality sign is set to 1, which means when the tracking value is above the preset limit, an alarm output will be triggered.

Press “V/A” to accept change and proceed to the next page.

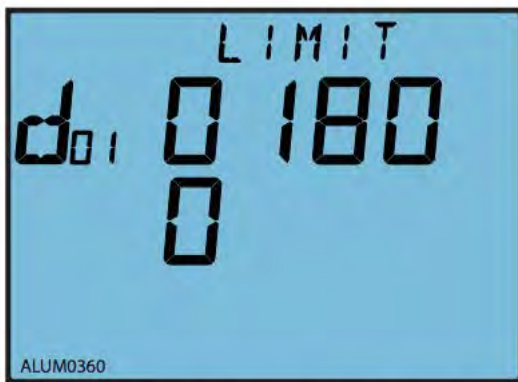

Fig.3-67 DO1 alarm limit setting

The 12th screen: DO1 alarm limit setting.

Set the alarming limit value for the tracking parameter.

As shown in Fig.3-67, the DO1 limit is set to 1800. Refer to Chapter 3.8 << Measurement Methods and Parameter Definitions >> for alarm limit value setting details.

Press “V/A” to accept change and proceed to the next page.

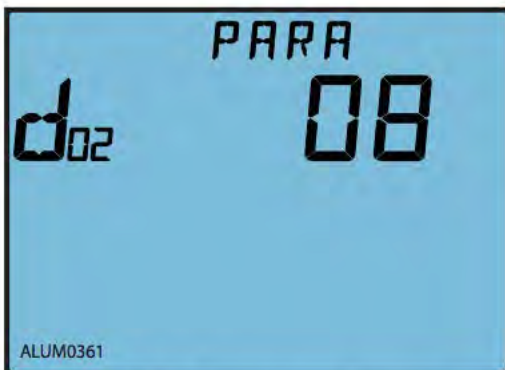

Fig.3-68 DO2 alarm output item setting

The 13th screen: DO2 alarm output item setting.

Same as DO1 alarm output item setting, refer to the alarm output item selection table shown above.

As shown in Fig.3-68, DO2 alarm parameter is 08, tracking object is Phase 2 current.

Press “V/A” to accept change and proceed to the next page.

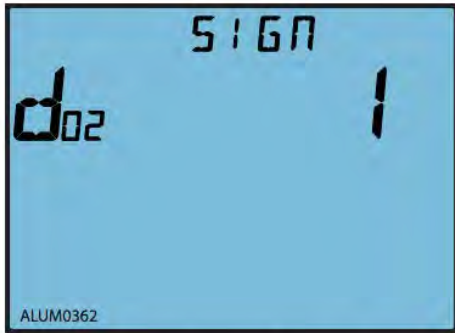

Fig.3-69 DO2 inequality sign setting

The 14th screen: DO2 inequality sign setting.

0: < (less than); 1: > (greater than)

Press “V/A” to accept change and proceed to the next page.

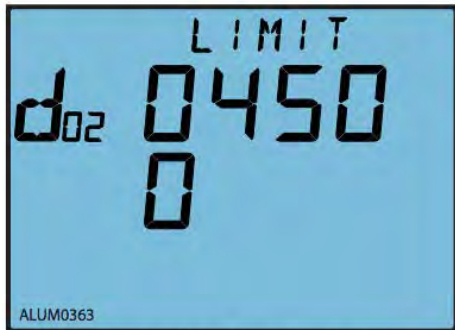

Fig.3-70 DO2 alarm limit setting

The 15th screen: DO2 alarm limit setting.

Set the alarming limit value for the tracking parameter.

Refer to Chapter 3.8 << Measurement Methods and Parameter Definitions>> for alarm limit value setting details.

As shown in Fig.3-70, the DO2 limit is set to 4500. This is the last screen of DO parameter setting.

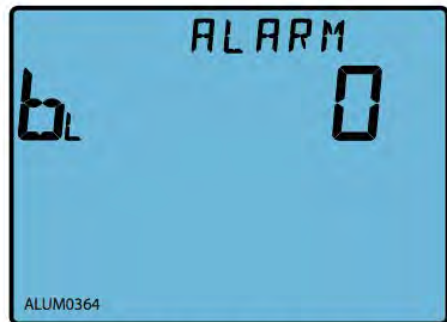

Fig.3-71 alarm back light blink setting

The 16th screen: backlight blinking setting. If the alarm backlight blinking is enabled, the screen displays “1”. As show in Fig.3-71, the backlight blinking is enabled. Under this circumstance, when an alarm is triggered, the backlight will be blinking at the same time. Press “P” or “E” to choose between “0” and “1”.

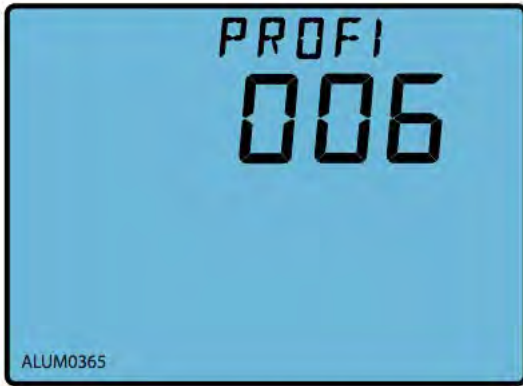

Fig.3-72 PROFIBUS address setting

The 17th screen: PROFIBUS address setting page.

PROFIBUS address can be set from 0~126, this page will display if the power meter connects a PROFIBUS module.

PROFIBUS address can be set only via key, and it valid right now after modified.

Only Acuvim-DL/EL display the page.

3.6 Ethernet Network Module Settings

For Acuvim-DL and EL, under any set of system parameters mode page, press the "H" and "P" key to enter the Network Settings page. Ethernet parameter setting mode key operation is the same as to system parameter setting mode key operation. Parameters have been set, simultaneously press the "P" key and the "H" key to exit the Ethernet parameter setting mode to return to the system parameter setting mode.

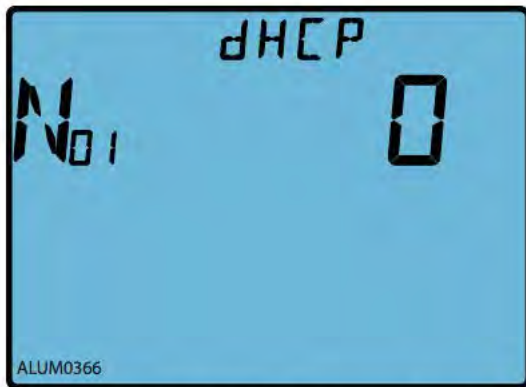

Fig.3-73 PROFIBUS address setting

The 1st screen: Displays the DHCP flag settings page. When set to 0, the static IP; set to 1, the dynamic IP.

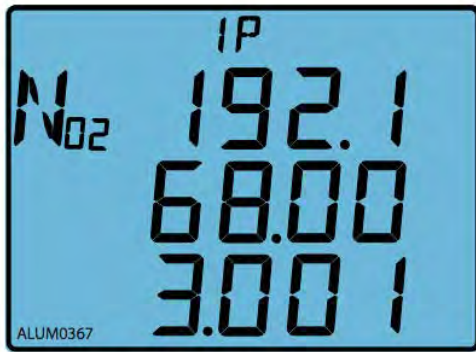

Fig.3-74 IP address setting

The 2nd screen: Displays the IP address settings page. IP address: 192.168.3.1

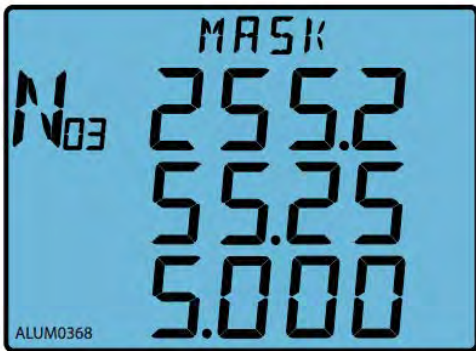

Fig.3-75 Subnet mask address setting

The 3rd screen: Displays the subnet mask address (SUBMASK) settings page. Such as the subnet mask address is: 255.255.255.0

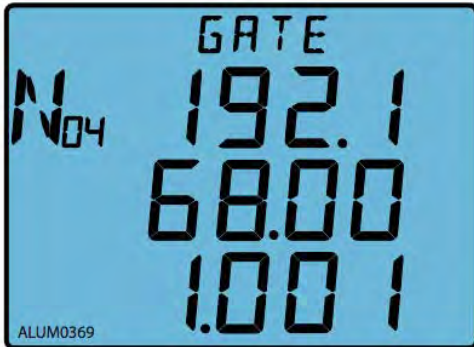

Fig.3-76 Gateway address setting

The 4th screen: Displays the gateway address (Gateway) settings page. Such as the gateway address: 192.168.1.1

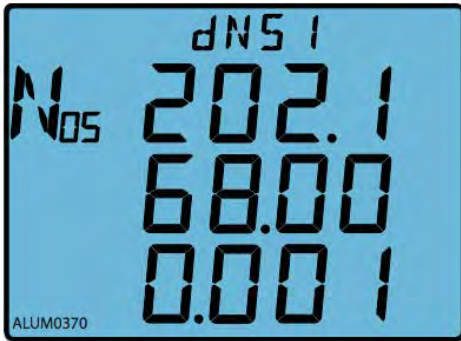

Fig.3-77 Domain name server(DNS1) setting

The 5th screen: Displays the IP address of the domain name server (DNS1) settings page. Such as server address 1:202.168.0.1

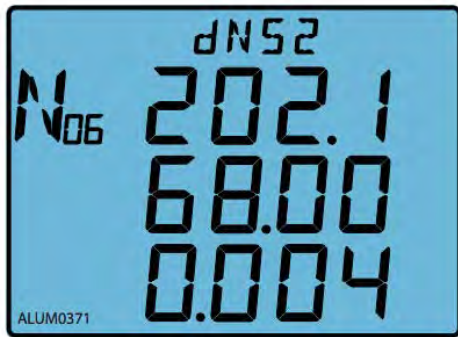

Fig.3-78 Domain name server(DNS2) setting

The 6th screen: Displays the domain name server address (DNS2) Settings page. Such as server address 2:202.168.0.4



Fig.3-79 MODBUS-TCP port setting

The 7th screen: MODBUS-TCP port setting page is displayed. Figure MODBUS-TCP address 5050.

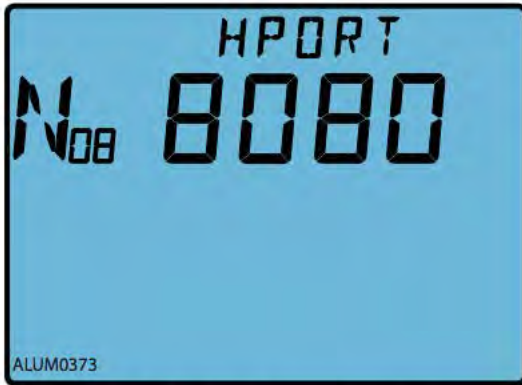

Fig.3-80 HTTP port setting

The 8th screen: Displays the HTTP port settings page. HTTP port address is 8080.

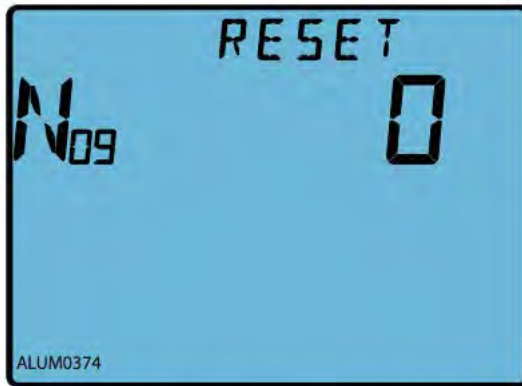

Fig.3-81 Network module reset setting

The 9th screen: Displays network module reset settings page. Is set to 1, the reset network module; such as 0, is not reset.

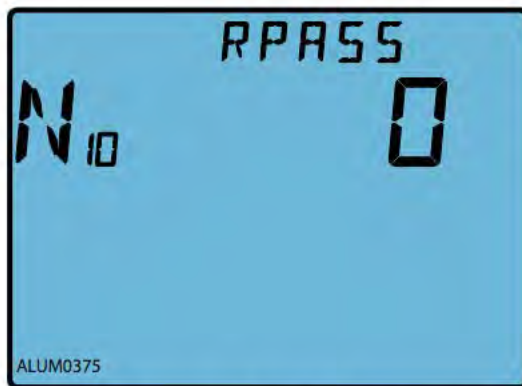

Fig.3-82 network module password reset setting

The 10th Screen: Displays the network module password reset page. Set to 1, reset network codes 12345678; set to 0 is not reset.

3.7 DI status Display function

Acuvim-DL and Acuvim-EL support display of 4 extend DI status. Press “H” + “P” can enter or exit DI status display. The pages can be turned by pressing “V/A”. From Fig. 3-83 to Fig. 3-86, it shows that all of the 4 DIs status are OFF.

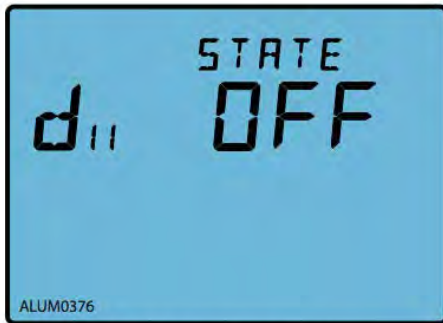

Fig.3-83 DI1 status display

The 1st screen: DI1 current status display. if DI1 status is turn on, the screen will display “ON”. if DI1 status is turn off, the screen will display “OFF”. As show in Fig.3-83, DI1 status is turn off.

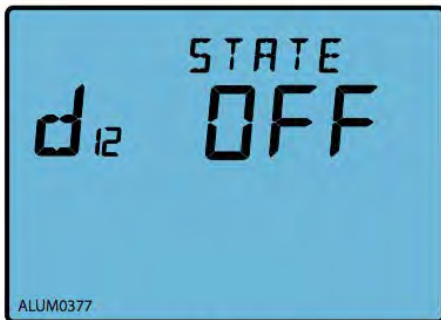

Fig.3-84 DI2 status display

The 2nd screen: DI2 current status display. if DI2 status is turn on, the screen will display “ON”. if DI2 status is turn off, the screen will display “OFF”. As show in Fig.3-84, DI2 status is turn off.

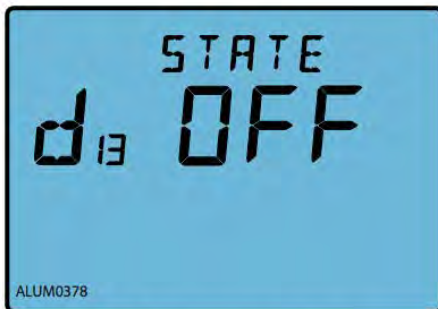

Fig.3-85 DI3 status display

The 3th screen: DI3 current status display. if DI3 status is turn on, the screen will display “ON”. if DI3 status is turn off, the screen will display “OFF”. As show in Fig.3-85, DI3 ststus is turn off.



Fig.3-86 DI4 status display

The 4th screen: DI4 current status display. if DI4 status is turn on, the screen will display "ON". if DI4 status is turn off, the screen will display "OFF". As show in Fig.3-86, DI4 sttus is turn off.

3.8 TOU Energy and Maximum Demand Display

Press "V/A" and "E" simultaneously to enter the TOU Energy and maximum demand page. Press "E" to display TOU Energy. Press "P" to display TOU Maximum Demand. Press "H" to change the tariffs page. it could display energy under different tariffs in Maximum Demand page. it could also display demand under different tariffs in maximum demand page. Press "V/A" and "E" simultaneously to exit to real-time metering mode.

On the top of the display page, "TOU" represents Time of Use related parameters; "0" represents the total tariff; "1" indicates the represents Time of Use; "2" indicates peak tariff; "3" indicates the valley tariff; "4" indicates the normal tariff. Press E to display the energy under different tariffs, as described below.

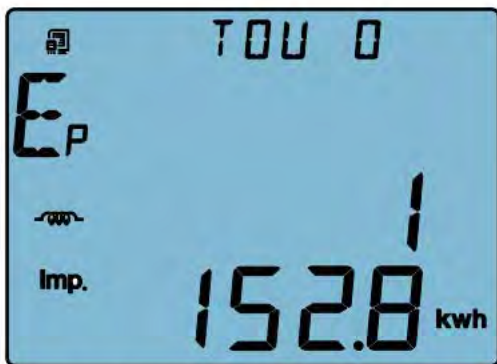

Fig.3-87 Total tariff import energy

The 1st screen: Total tariff import energy. As shown in Fig.3-87, Ep_Imp=1152.8kWh. Press "V/A" to turn to the next screen.

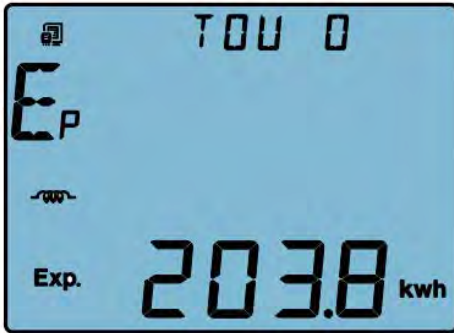

Fig.3-88 Total tariff export energy

The 2nd screen: Total tariff export energy. As shown in Fig.3-88, Ep_ Exp=203.8kWh. Press “V/A” to turn to the next screen.

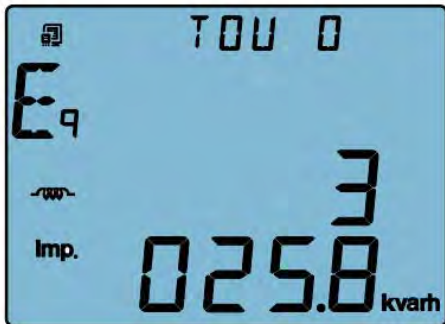

Fig.3-89 Total tariff import reactive energy

The 3rd screen: Total tariff imports reactive energy. As shown in Fig.3-89, Eq_ Imp=3025.8 kvarh. Press “V/A” to turn to the next screen.



Fig.3-90 Total tariff export reactive energy

The 4th screen: Total tariff export reactive energy. As shown in Fig.3-90, Eq_ Exp=7142.6 kvarh. Press “V/A” to go to the next screen.

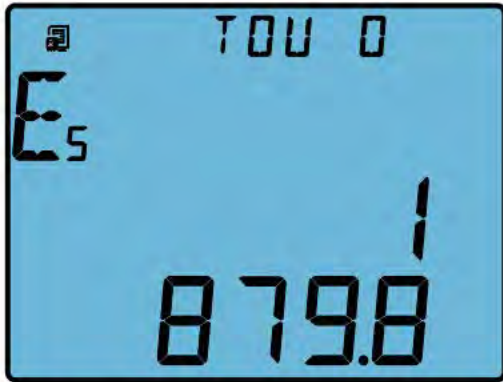

Fig.3-91 Total tariff apparent energy

The 5th screen: Total tariff apparent energy of TOU. As shown in Fig.3-91, $E_5=1879.8$ kWh. Press “V/A” return to 1st screen, then press “H” turn to 6th screen.

In the same way, press “V/A” key to switch the screen under the same tariffs.

Press “H” will switch the screen under the different tariffs.

Press “P” would display the maximum demand under each tariff in the TOU energy screen, the following paragraphs introduce Maximum Demand in details.

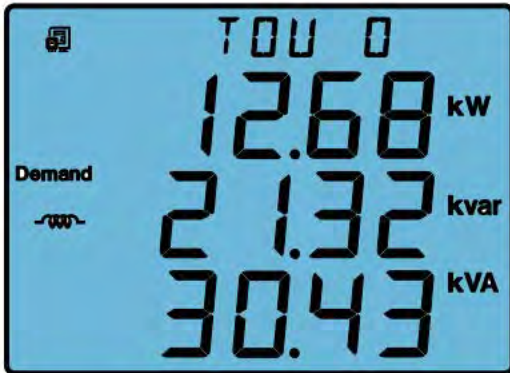

Fig.3-92 Total tariff maximum power demand

The 1st screen: Total tariff maximum power demand. As shown in Fig.3-92, $P_1 = 12.68$ kW, $P_2 = 21.32$ kvar, $P_3 = 30.43$ kVA. Press “V/A” to go to the next screen.

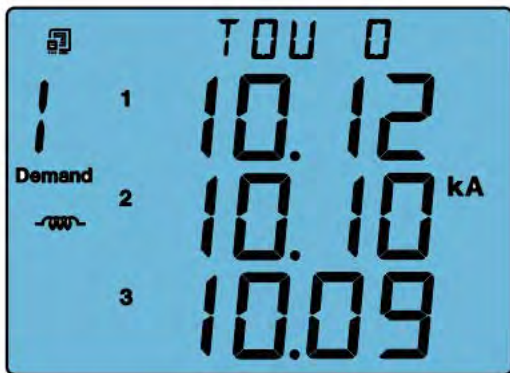

Fig.3-93 Total tariff maximum current demand

The 2nd screen: Total tariff maximum current demand. As shown in Fig. 3-93, I1 = 10.12kA, I2 = 10.10kA, I3 = 10.09 kA, Press “V/A” to switch the screen between maximum power demand and maximum current demand.

Press “H” to switch the screen under the different tariffs.

3.9 Acuvim-L Measurement Methods and Parameter Definitions

Almost all the electric parameters in power systems can be measured by the Acuvim-L series meter. The following section introduces those parameters in more details.

Voltage (U): True RMS value of three phase voltages, three line to line voltages is measured and displayed in the Acuvim-L series meter.

Current (I): True RMS value of three phase current, neutral current is measured and displayed in the Acuvim-L series meter.

Power (P): Three phase power and total system power are measured and displayed in the Acuvim-L series meter.

Reactive power (Q): Acuvim-L series meter uses the following two methods for reactive power calculation.

1. Sinusoidal reactive power. The formula is as follows:

$$Q^2 + D^2 = S^2 - P^2$$

2. Nonsinusoidal reactive power. The formula is as follows:

$$Q' = \sqrt{Q^2 + D^2}$$

Where Q_D : Budeanu's distortion power.

Q : Budeanu's reactive power.

Apparent power (S): Three phase apparent power and total system apparent power are measured and displayed in the Acuvim-L series meter.

Power factor (PF): Three phase power factor and total system power factor are measured and displayed in the Acuvim-L series meter.

Frequency (F): The frequency of phase voltage input is measured as system frequency.

Energy (kWh): Energy is time integral of power. The unit is kWh. Since power is measured in bi-direction, positive means importing and negative means exporting, energy is also expressed according to the power direction.

Import energy (Ep_imp): Energy imports from a source.

Export energy (Ep_exp): Energy exports to a source.

Reactive energy (kvarh): reactive energy is time integral of reactive power. The unit is kvarh. Since reactive power is measured in bi-direction, positive means inductive and negative means capacitive, reactive energy is also expressed according to the load nature.

Import reactive energy (Eq_imp): inductive energy

Export reactive energy (Eq_exp): capacitive energy.

Apparent energy: apparent energy is time integral of apparent power. The unit is kVAh.

Harmonic parameter (not available for Acuvim-EL):

Total harmonic distortion: this factor is often used to express the power quality of the power system. The formula is as follows:

$$THD = \sqrt{\sum_{h=2}^9 \left(\frac{U_h}{U_1}\right)^2} \times 100\%$$

In the formula, U1 is Rms value of the voltage fundamental and Uh is Rms value of the voltage harmonic with order n.

Each harmonic rate: the percentage of each harmonic is divided by the fundamental.

$$HRU_h = \frac{U_h}{U_1} \times 100\% \quad HRI_h = \frac{I_h}{I_1} \times 100\%$$

Demand: real power demand, reactive power demand, total system power demand, and three phase current demand can be measured with the Acuvim-L series meter. The meter uses sliding window method for demand calculation. Demand interval can be selected from 1 to 30 minutes. Demand window slides one minute each time. For example, the demand interval is set as 3 minutes. If the total power of the 1st minute is 12, the 2nd minute is 14 and the 3rd minute is 10, the total power demand of the 3 minutes is (12+14+10)/3=12. If another minute passed by (the 4th minute) and the total power for the minute is 9, the total power demand after 4 minutes, according to the 3-minute interval, should be (14+10+9)/3 = 11.

Max/Min: Acuvim-L series meter can measure the max value of real system power, reactive power and apparent power and the max/min of the three-phase voltage and current. The data is stored in non-volatile memory and can be accessed or cleared via meter front or communication.

Unbalance factor: Acuvim-L series meter can measure unbalance factor of three –phase voltage and current using sequence vector method. The formula of voltage and current unbalance factor as follows:

Voltage unbalance factor = (RMS value of V1 (V12) negative component of the fundamental wave / RMS value of V1 (V12) positive component of fundamental wave) x 100 %

Current unbalance factor = (RMS value of I1 negative component of the fundamental wave / RMS value of I1 positive component of fundamental wave) x 100 %

Energy measurement: The energy measurement type includes real time energy measurement and time of use (Acuvim-EL only) energy measurement. The function is described as follows:

Real time energy: the accumulation of energy for the kWh, kvarh and kVAh since cleared last time. The real time energy includes each single-phase energy, which could be useful for observing the increment of single-phase energy.

Time of use (TOU): User can assign up to 4 different tariffs (sharp, peak, valley and normal) to different time period within a day according to the billing requirements. The meter will calculate and accumulate energy to different tariffs according to the meter's internal clock timing and TOU settings.

TOU setting: User can set a maximum of 12 TOU seasons, each season can be assigned to a TOU schedule (a maximum of 14 TOU schedules are available). Each 73 Acuvim-L schedule can be divided up into 14 segments (in which each segment can have its own tariff).

User can customize the TOU calendar (including its tariffs, seasons, schedules and segments) according to different applications. To make sure that the TOU calendar is setup correctly, the meter will check the TOU settings according to the predefined rules (see below for "TOU setting format requirement" for details). TOU function will be disabled if the TOU calendar is set up incorrectly. If no errors are found in the calendar and the TOU function is enabled, TOU energy accumulation will begin.

TOU setting format requirement:

- 1) Season setting parameter: The calendar year will be divided up into different seasons depending on the season setting parameter. The parameter can be selected from any integer between 1 to 12. User must enter the correct value for the season setting parameter in accordance to the TOU season table. If the season setting parameter is set as 2, the first 2 slots of the TOU season table must be set, otherwise it will be considered as an invalid input (TOU function will be disabled).

- 2) TOU season format: Enter the start date into the TOU season table slot following this format “MM-DD ID” - MM stands for the month, DD stands for the day and ID stands for the TOU schedule ID (available from 01 to 14). The dates should be organized so that they are in sequence according to the calendar year (the earlier date comes first and the later date comes last). For example, if 3 seasons are selected, the date parameters are January 1, June 6 and September 7, and TOU schedule 02, 01, 03 will be used respectively, the first TOU season table slot shall enter 01-01 02, the second slot shall enter 06-06 01, and the third slot shall enter 09-07 03. Entering 01-01 02 for the first slot, 09-07 03 for the second slot and 06-06 01 for the third slot is considered invalid.
- 3) Schedule setting parameter: The number of available TOU schedules depends on the schedule setting parameter. The parameter can be selected from any integer between 1 to 14. This parameter determines the number of TOU schedules available for the TOU calendar setting. A maximum of 14 TOU schedules (from TOU Schedule #1 to TOU Schedule #14) can be used.
- 4) Segment setting parameter: Each TOU schedule consists of various timing segments. The number of segments depends on the segment setting parameter setup. The parameter can be selected from any integer between 1 to 14 (inclusively). User must enter the correct value for the segment setting parameter in accordance to the TOU schedule table. If the segment setting parameter is set as 3, the first 3 slots of the TOU schedule table must be set, otherwise, it will be considered as an invalid input (TOU function will be disabled).
- 5) TOU schedule format: Each TOU schedule represents a 24-hour cycle. Similar to TOU season format, enter the start time into the TOU schedule table slot following this format “HH:MM ID” - HH stands for hour (in 24 hr format), MM stands for minutes and ID stands for tariffs (available from 00 to 03). The time should be organized according to the hour sequence. For example, if 3 segments are selected, timing parameters are 01:00, 15:30, 22:45, the order of the 3 segments should be one of the following: 01:00, 15:30, 22:45 or 15:30, 22:45, 01:00 or 22:45, 01:00, 15:30 Entering time information in a wrong sequence (for example, entering 15:30, 01:00, 22:45) is considered as an invalid operation, TOU function will be disabled.

- 6) **Tariff setting parameter:** This parameter corresponds to the number of tariffs available for the TOU calendar and can be selected from any integer from 0 to 3. The four tariffs: sharp, peak, valley and normal are represented by 4 integers: 0, 1, 2 and 3 respectively. If the tariff setting parameter is set to 3, all of the 4 tariffs will be available for the TOU calendar; if the parameter is set to 1, only the first 2 75 Acuvim-L tariffs (sharp and peak) will be available.
- 7) **Holiday setting parameter:** This parameter can be set from any integer between 1 and 30, meaning a maximum of 30 holidays can be programmed to the TOU calendar. If the holiday setting parameter is set as 3, the first 3 slots of the holiday schedule must be set, otherwise it will be considered as an invalid input (TOU function will be disabled).

Note: User can either customize the TOU calendar factory settings or use the default factory settings. User can reset the TOU calendar to its default value either via communication.

- 8) **Holiday schedule:** The holiday schedule uses the same format as the TOU seasons “MM-DD ID”. User can select which TOU schedule to be used for the holiday. The dates of the holiday schedule do not need to be organized in a sequential order (i.e. the first slot can be January 1, the second slot can be December 26 and the third slot can be December 25).
- 9) **Daylight saving time (DST):** under the circumstance that DST is enabled, if you choose the fixed date option, you set a fixed date for DST, the format is month / day / hour / minute / adjust the time (in minute). If you choose the non-fixed data option, you set a day in a week for DST, the format is month / which week/ day / hour /minute / adjust time (in minute). Once DST is enabled, DST will be automatically implemented by the chosen option.

When the clock starts to run DST, the meter will automatically adjust the clock for a settable time period in advance. When the clock runs to the end of DST, the meter will automatically adjust the clock back for a settable time period.

Daylight Saving Time

DST Enable DST Format Format 1

Format 1

DST Start
Apr 1 Day 12 Hour 25 Min Adjust Time 5 Minutes

DST Ending
Jul 2 Day 0 Hour 12 Min Adjust Time 45 Minutes

Format 2

DST Start
Mar 2nd Thu at 11 : 23 Adjust Time 2 Minutes

DST Ending
Apr 2nd Sun at 23 : 35 Adjust Time 60 Minutes

Fig.3-94 DST setting interface

10. Holidays pre-set function: Ten years holiday setting

In this setting, users can program holidays in the future decade. The format is month/day, holiday code.

When “Enable Holiday Years Settings” is checked, users can click “Make Holiday Settings (10 Year)” to enter the holiday table setup page. Once the setup is done, users can click “Generate”, by which a holiday table for the next decade can be generated. Figure 3-94 depicts a ten-year holiday table.

Enable Holidays Years Settings

Start Year Ending Year

1st Year Holidays

1	<input type="text" value="01-01 1"/>	<input type="text" value="02-01 2"/>	<input type="text" value="03-01 3"/>	<input type="text" value="04-01 4"/>	<input type="text" value="05-01 5"/>	<input type="text" value="00-00 00"/>	6
7	<input type="text" value="00-00 00"/>	<input type="text" value="00-00 00"/>	<input type="text" value="00-00 00"/>	<input type="text" value="00-00 00"/>	<input type="text" value="00-00 00"/>	<input type="text" value="00-00 00"/>	12
13	<input type="text" value="00-00 00"/>	<input type="text" value="00-00 00"/>	<input type="text" value="00-00 00"/>	<input type="text" value="00-00 00"/>	<input type="text" value="00-00 00"/>	<input type="text" value="00-00 00"/>	18
19	<input type="text" value="00-00 00"/>	<input type="text" value="00-00 00"/>	<input type="text" value="00-00 00"/>	<input type="text" value="00-00 00"/>	<input type="text" value="00-00 00"/>	<input type="text" value="00-00 00"/>	24
25	<input type="text" value="00-00 00"/>	<input type="text" value="00-00 00"/>	<input type="text" value="00-00 00"/>	<input type="text" value="00-00 00"/>	<input type="text" value="00-00 00"/>	<input type="text" value="00-00 00"/>	30

Settings Year Holiday Number

2nd Year Holidays

1	<input type="text" value="01-01 1"/>	<input type="text" value="02-01 2"/>	<input type="text" value="03-01 3"/>	<input type="text" value="04-01 4"/>	<input type="text" value="05-01 5"/>	<input type="text" value="06-01 6"/>	6
7	<input type="text" value="07-01 7"/>	<input type="text" value="08-01 8"/>	<input type="text" value="09-01 9"/>	<input type="text" value="10-01 10"/>	<input type="text" value="00-00 00"/>	<input type="text" value="00-00 00"/>	12
13	<input type="text" value="00-00 00"/>	<input type="text" value="00-00 00"/>	<input type="text" value="00-00 00"/>	<input type="text" value="00-00 00"/>	<input type="text" value="00-00 00"/>	<input type="text" value="00-00 00"/>	18
19	<input type="text" value="00-00 00"/>	<input type="text" value="00-00 00"/>	<input type="text" value="00-00 00"/>	<input type="text" value="00-00 00"/>	<input type="text" value="00-00 00"/>	<input type="text" value="00-00 00"/>	24
25	<input type="text" value="00-00 00"/>	<input type="text" value="00-00 00"/>	<input type="text" value="00-00 00"/>	<input type="text" value="00-00 00"/>	<input type="text" value="00-00 00"/>	<input type="text" value="00-00 00"/>	30

Settings Year Holiday Number

Fig.3-95 ten years holiday table

11. Weekend Schedule: Weekend Setting (bit0 : Sunday; bit1 ~ bit6: Monday to Saturday; bit 0 means not effective, bit 1 means effective). For example, when the Weekend Setting bit0 is 1, it means Sunday is effective. When the Weekend Setting bit1 is 1, it means Monday is effective. For example, if a user wants to set Saturday and Sunday effective, he should put 65 (1000001) into the Weekend Setting field. When the meter clock is within the pre-set Weekend Schedule, the energy will accumulate under the tariff that corresponds to the Schedule.

Note: Holiday schedule has the highest priority among all the schedules followed by the Weekend Schedule. That is, when set appropriately, holiday and weekend schedules override normal (weekday) TOU settings. When a holiday falls in a weekend, the holiday schedule overrides the Weekend Schedule.

Record and Clear of Maximum Demand

Acuvim-EL could record the maximum power and current demand under different tariffs, when the TOU Function is enabled and the setting of time table is correct. It also can clear the value under different tariffs.

There are two ways of resetting Current Month TOU:

1. End of Month: This is the default method. All values from Current Month TOU will be copied over to Prior Month TOU at the very beginning of each month (the first day of each month at time 00:00:00).
2. Assign: User can select when should the values from Current Month TOU be copied over to Prior Month TOU. User can set the time in the following format “DD HH:MM:SS” - DD stands for day, HH stands for hour, MM stands for minute, SS stands for second. Similar to the previous method, once Current Month TOU is transferred to Prior Month TOU.

Over/Under limit alarming: Acuvim-BL, DL, EL has over/under limit alarming capability if you want to learn more please read the introduction of extend IO 79 function chapter.

Energy Pulse Output: The two digital outputs (DOs) from the Acuvim-BL, DL, EL can be used as energy pulse output.

Introduction of extend IO function: As shown in Fig.3-95 extended IO parameter setting, it includes DO type, DI type and Communication settings.

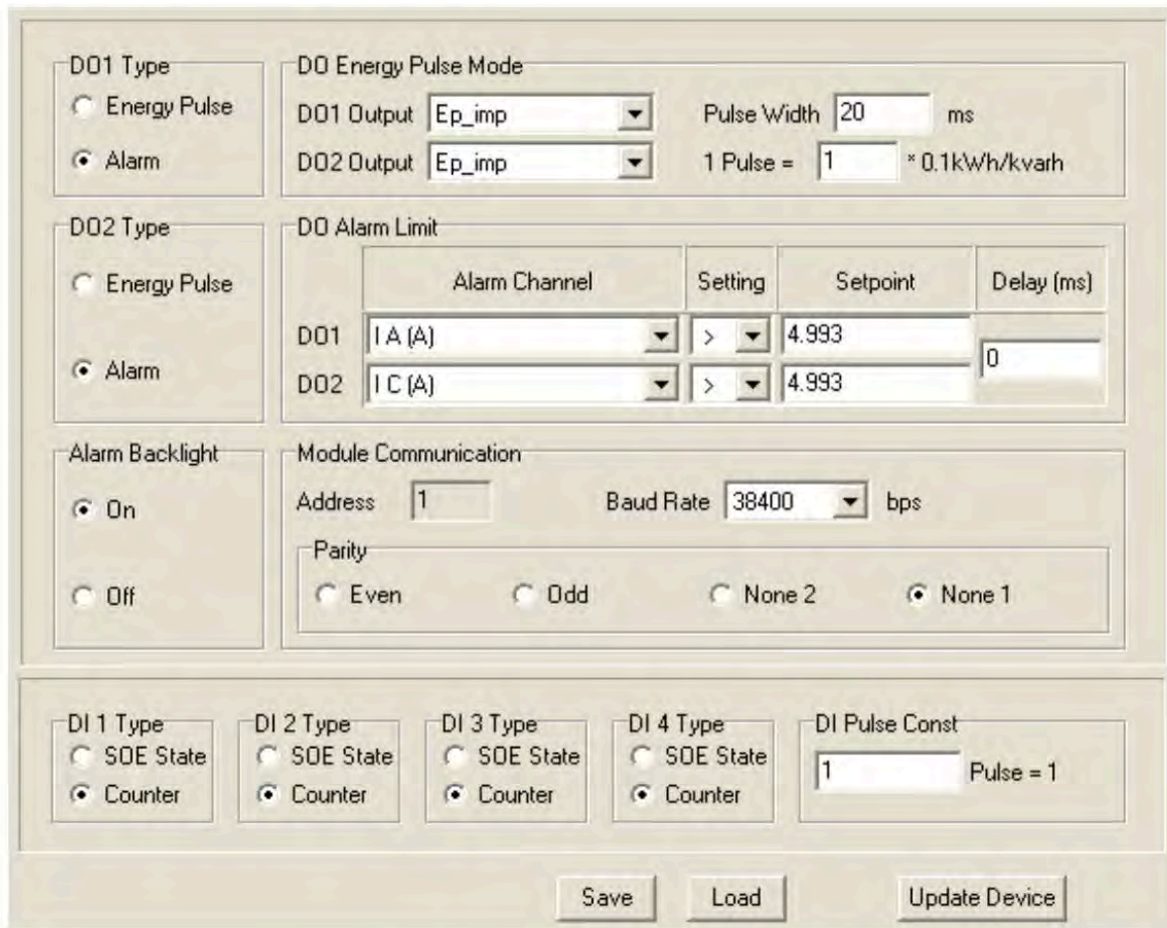

Fig.3-96 Extend IO parameter setting

Extension IO communication:

Acuvim-EL and Acuvim-DL extended IO module supports RS485 communications with Modbus-RTU protocol, the extended module share the same device address and it supports six baud rate: 1200, 2400, 4800, 9600, 19200, 38400, 57600 as well as different parity selections. The setting of baud rate and parity check can implement by software and meter display screen. It can be implemented by software or from the meter front. The instrument can be connected with the PROFIBUS communication module at the same time. For detailed content, please refer to Acuvim-L Profibus Modules User’s Manual. In addition, the meter can be connected to the Ethernet network communication module. Modbus-TCP/IP protocol communication, web access, timing mail send and other functions can be realized. For details, please refer Ethernet Module User’s Manual

Digital output (DO)

As shown in Fig.3-95, the DO type includes alarm output and energy pulse output. DO type can be set via software as well.

Over/Under limit alarming:

Acuvim-BL, Acuvim-DL and Acuvim-EL has over/under limit alarming capability. When the monitored parameter goes beyond/below the preset limit and stays at the level over the preset amount of time delay, the over/under limit alarm will be triggered. The meter LCD screen backlight will flash and the corresponding digital output (DO) will be activated until the parameter condition returns to normal. Upon alarming, DO can be used to activate devices such as safety beacon light and buzzer. Each DO supports 1 alarming parameter. An over/under limit alarming example is shown below.

For example:

Alarming Condition: when Phase B current goes above 180A (CT ratio is set as 81 Acuvim-L 200:5) for over 15 seconds, over limit alarm will be triggered, alarm signal will be set out via DO1. Setting procedures should be as follows: Enter DO parameter setting mode by pressing “P” and “E” simultaneously under system parameter setting mode.

- 1) Set DO1 mode to 1 (alarm output)
- 2) Set delay time to 50 (the base unit of delay time is 300ms, the setting value should be $15/0.3=50$)
- 3) Set alarming parameter to 8 (tracking object for parameter 8 is Phase B current)
- 4) Set inequality sign to 1 (greater than)
- 5) Set alarm value to 4500 (according to Table 4-9. Conversion relationship of basic measurements from Chapter 4.4 <>, the setting relationship is $I=R_x*(CT1/CT2)/1000$, $R_x=4500$) Press “V/A” to accept change then press “P” and “E” simultaneously to exit DO parameter setting mode.

Energy Pulse Output:

Acuvim-BL, Acuvim-DL and Acuvim-EL has Energy pulse output function. Each energy pulse output channel can be set to monitor one of the four energy parameters (Ep_imp, Ep_exp, Eq_imp or Eq_exp). Pulse constant and pulse width can also be set according to user’s requirement. Pulse constant stands for amount of energy (kWh or kvarh) per pulse; pulse width stands for the time duration for each pulse. DO will send out a pulse signal when the accumulated energy reaches the pulse constant value. Related parameters: pulse energy output ranges from 0 to 4 corresponding to none, Ep_imp, Ep_exp, Eq_imp, Eq_exp. Pulse constant ranges from 800 to 60000; Pulse width ranges from 1 to 50 (word) with a unit of 20ms. The shortest interval between two pulses is 20ms. 82 Acuvim-L In practice the pulse width and the pulse ratio are selected according to system power. The relation of the two parameters should satisfied following expression: $((1000 \times 3600s) / P * Pulse_Const) > pulse\ width$. In the expression, the unit of the power or reactive power is w or var.

Digital Input (DI)(DL, EL)

Newest SOE Record No.		16					
No.	Time Stamp	ms	DI 1	DI 2	DI 3	DI 4	
1	2009-11-2 15:40:42	205	OFF	OFF	OFF	OFF	
2	2009-11-2 16:32:26	406	OFF	OFF	OFF	OFF	
3	2009-11-2 16:32:29	826	OFF	ON	OFF	OFF	
4	2009-11-2 16:32:39	503	OFF	OFF	OFF	OFF	
5	2009-11-2 16:32:50	363	OFF	ON	OFF	OFF	
6	2009-11-2 16:32:54	789	OFF	OFF	OFF	OFF	
7	2009-11-2 16:32:59	923	OFF	ON	OFF	OFF	
8	2009-11-2 16:33:02	724	OFF	OFF	OFF	OFF	
9	2009-11-2 16:33:04	892	OFF	ON	OFF	OFF	
10	2009-11-2 16:33:16	27	OFF	OFF	OFF	OFF	
11	2009-11-2 16:33:17	483	OFF	ON	OFF	OFF	
12	2009-11-2 16:33:20	424	OFF	OFF	OFF	OFF	
13	2009-11-2 16:33:23	168	OFF	ON	OFF	OFF	
14	2009-11-2 16:33:39	685	OFF	OFF	OFF	OFF	
15	2009-11-2 16:33:40	216	OFF	ON	OFF	OFF	
16	2009-11-2 16:33:46	801	OFF	OFF	OFF	OFF	
17	2009-11-2 15:30:33	150	OFF	OFF	OFF	OFF	
18	2009-11-2 15:40:13	285	OFF	OFF	OFF	ON	
19	2009-11-2 15:40:32	612	OFF	OFF	OFF	OFF	
20	2009-11-2 15:40:39	273	OFF	OFF	OFF	ON	

Fig.3-97 SOE record display



Fig.3-98 DI counter and status display

(1) DI function introduction:

The DI type can be set as shown in Fig.3-95 Extend IO parameter setting.

If SOE record function is selected, the DI will work as SOE state mode as shown Fig. 3-96 SOE record display; if the counter is selected, the DI will work as input pulse accumulation mode as shown in Fig.3-87 DI count and status display.

(2) SOE (Sequence of Event) function:

- 1) At present, the event allows the cycle of 20 SOE recording. When DI is in SOE state mode, once the DI input level changes occur, an SOE event will be recorded. In this way, it will achieve 20 SOE event loop recording. The event format: Year, Month, Day, Minute, Seconds, Millisecond, DI status.
- 2) SOE function judges the single read event value. When a single event is read, if the value is not the latest event in the log, it reads this single event and the record number will be increased. If a record is the latest event, the incident remains unchanged. The previous events can be read by the record numbers. If the value is not currently reading the latest value of the event log, it reads the current single event and the record number will be incremental, if current reading record number is the latest event record number, a single incident remains unchanged. by re-written a single event number, the user can implement the previous event re-read.

(3) Pulse Counter function: When the DI type is set to Pulse Counter, corresponding to the accumulated pulse constant value, it achieves the cumulative function of DI input pulses. If pulse constant is 1, DI input receives 1 input signal then cumulative pulse amount adds 1. If pulse constant is 10, DI input receives 10 pulses then cumulative pulse amount adds 1.

Acuvim-L Series Power Meter

Chapter 4: Communications

4.1 Modbus Protocol Introduction

4.2 Modbus Protocol

4.3 Communication Format

4.4 Ethernet Module (AXM-NET)

4.5 Data Address Table

Chapter 4 Communications

This chapter will mainly discuss how to operate the meter via communication port using software. To master this chapter, you should be familiar with Modbus and read other chapters of this manual to make sure that you have a good understanding of the functions and applications of this product.

This chapter includes: Modbus protocol, format of communication and data address table and Acuvim-L application details.

4.1 Modbus Protocol Introduction

Modbus™ RTU protocol is used for communication in Acuvim-L series meter. Data format and error check methods are defined in Modbus protocol. The half-duplex query and respond mode is adopted in Modbus protocol. There is only one master device in the communication net. The others are slave devices, waiting for the query of the master.

Transmission mode

The mode of transmission defines the data structure within a frame and the rules used to transmit data. The mode is defined in the following which is compatible with Modbus RTU Mode*.

* Modbus is trademark of Modicon, Inc.

Coding System	8-bit binary
Start bit	1
Data bits	8
Parity	NO parity; Odd parity; EVEN parity
Stop bit	1 or 2
Error checking	CRC check

4.2 Modbus Protocol

Framing

Table 4-1 data frame format

Address	Function	Data	Check
8-bit	8-bit	Nx8-bit	16-bit

Address field

The address field of a message frame contains eight bits. Valid slave device addresses are in the range of 0~247 decimal. A master addresses a slave by placing the slave address in the address field of the message. When the slave sends its response, it places its own address in this address field of the response to let the master know which slave is responding.

Function field

The function code field of a message frame contains eight bits. Valid codes are in the range of 1~255 decimal. When a message is sent from a master to a slave device the function code field tells the slave what kind of action to perform.

Table 4-2 Function code

Code	Meaning	Action
01	Read Relay Output Status	Obtain current status of Relay Output
02	Read Digital Input (DI) Status	Obtain current status of Digital Input
03	Read Data	Obtain current binary value from one or more registers
16	Preset multiple-registers	Place specific value into a series of consecutive multiple-registers

Data field

The data field is constructed using sets of two hexadecimal digits, in the range of 00 to FF hexadecimal. The data field of messages sent from a master to slave devices contains additional information which the slave must use to take the action defined by the function

code. This can include items like discrete and register addresses, the quantity of items to be handled, and the count of actual data bytes in the field. For example, if the master requests a slave to read a group of holding registers (function code 03), the data field specifies the starting register and how many registers are to be read. If the master writes to a group of registers in the slave (function code 10 hexadecimal), the data field specifies the starting register, how many registers to write, the count of data bytes to follow in the data field, and the data to be written into the registers.

If no error occurs, the data field of a response from a slave to a master contains the data requested. If an error occurs, the field contains an exception code that the master application can use to determine the next action to be taken. The data field can be nonexistent (of zero length) in certain kinds of messages.

Error Check Field

Every message includes an error checking field which is based on the Cyclical Redundancy Check (CRC) method. The CRC field checks the contents of the entire message. It is applied regardless of any parity check method used for the individual characters of the message. The CRC field is two bytes long, containing a 16-bit binary value. The CRC value is calculated by the transmitting device, and is appended to the message.

The receiving device recalculates the CRC value during reception of the message, and compares the calculated value to the actual value it received in the CRC field. An error will be reported if the two values are not equal. CRC calculation is first started by preloading the whole 16-bit register to 1's. The process begins by 89 Acuvim-L applying successive 8-bit bytes of the message to the current contents of the register. Only the eight bits of data in each character are used for generating the CRC. Start and stop bits, and the parity bit, do not apply to the CRC.

When generating the CRC, each 8-bit character is exclusive ORed with the register contents. The result is shifted towards the least significant bit (LSB), with a zero filled into the most significant bit (MSB) position. The LSB is extracted and examined, if the LSB equals to 1, the register is exclusive ORed with a preset, fixed value; if the LSB equals to 0, no action will be taken. This process is repeated until eight shifts have been performed. After the last (eighth) shift, the next 8-bit byte is exclusive ORed with the register's current value, and the process repeats for eight more shifts as described above. After all the bytes of the message have been applied, the final contents of the register, which should exchange the high-byte and the low-byte, is the CRC value. When the CRC is appended to the message, the low-order byte is appended first, followed by the high-order byte.

4.3 Communications Format

Explanation of frame

Table 4-3 Explanation of a frame

Addr	Fun	Data start reg HI	Data start reg LO	Data #of regs HI	Data #of regs LO	CRC16 HI	CRC16 LO
06H	03H	00H	00H	00H	21H	84H	65H

As shown in table 4-3 the meaning of each abbreviated word is: Addr: Address of slave device

Fun: Function code

Data start reg HI: Start register address high byte

Data start reg LO: Start register address low byte

Data #of reg HI: Number of register high byte

Data #of reg LO: Number of register low byte

CRC16 HI: CRC high byte

CRC16 LO: CRC low byte

1. Read Status of Relay (Function Code 01)

This function code is used to read status in Acuvim-EL.1=On, 0=Off;

There are 2 Relays in Acuvim-DL/EL. The Address of each Relay is Relay1=0000H and Relay2=0001H.

The following query is to read Relay Status of Acuvim-EL Number 17.

Query

Table 4-4 Read the status of Relay1 and Relay2 Query Message

Addr	Fun	Relay start reg HI	Relay start reg LO	Relay #of regs HI	Relay #of regs LO	CRC16 HI	CRC16 LO
11H	01H	00H	00H	00H	02H	BFH	5BH

Response

The Acuvim-DL/EL response includes the Acuvim-DL/EL address, function code, quantity of data byte, the data, and error checking. An example response to read the status of Relay1 and Relay2 is shown as Table4-5 The status of Relay1 and Relay2 are responding to the last 2 bits of the data.

Relay1: bit0 Relay2: bit1

Table 4-5 Relay status Response

Addr	Fun	Byte count	Data	CRC16 HI	CRC16 LO
11H	01H	01H	02H	BFH	5BH

The content of the data is:

7	6	5	4	3	2	1	0
0	0	0	0	0	0	1	0
MSB						LSB	

(Relay 1 = OFF , Relay 2=ON)

2. Read the status of DI(Function 02)

Function Code 02

1=On 0=Of

DI1's address is 0x0000, DI2's address is 0x0001, and so on.

The following query is to read the Status of 4 DIs of Acuvim-DL/EL with the address of 17.

Query

Table 4-6 Read 4 DIs Query Message

Addr	Fun	DI start reg HI	DI start reg LO	DI num HI	DI num LO	CRC16 HI	CRC16 LO
11H	02H	00H	00H	00H	04H	7BH	59H

Response:

The Acuvim-DL/EL response includes the Acuvim-DL/EL address, function code, quantity of data characters, the data characters, and error checking. An example response to read the status of 4 DIs are shown as Table 4-7 The status of 4 DIs are responding to the last 4 bits of the data.

DI1: bit0; DI2: bit1; DI3: bit2; DI4: bit3.

Table 4-7 Read status of DI

Addr	Fun	Byte count	Data	CRC16 HI	CRC16 LO
11H	01H	01H	03H	E5H	49H

The content of the data is:

0	0	0	0	DI4	DI3	DI2	DI1
0	0	0	0	0	0	1	1
MSB				LSB			

3. Read Data (Function Code 03)

Query

This function allows the master to obtain the measurement results from the Acuvim-L series meter. Table 4-8 is an example to read the 3 measured data (F, V1 and V2) from slave device number 17, the data address of F is 0130H, V1 is 0131H and V2 is 0132H.

Table 4-8 Read F, V1 and V2 Query Message

Addr	Fun	Data start addr HI	Data start addr LO	Data #of Regs HI	Data #of LO	CRC16 Hi	CRC16 Lo
11H	03H	01H	30H	00H	03H	06H	A8H

Response

The Acuvim-L series meter response includes the address code, function code, quantity of data byte, data, and error checking. An example response to read F, V1 and V2 (F=1388H (50.00Hz), V1=03E7H (99.9V), V2=03E9H (100.1V)) is shown as Table 4-9.

Table 4-9 Read F, V1 and V2 Message of response

Addr	Fun	Byte count	Data1 HI	Data1 LO	Data2 Hi	Data2 LO	Data3 HI	Data3 LO	CRC16 HI	CRC16 LO
11H	03H	06H	13H	88H	03H	E7H	03H	E9H	7FH	04H

4. Preset / Reset Multi-Register (Function Code 16)

Query

Function 16 allows the user to modify the contents of a multi-register. Any register that exists within the Acuvim-L series meter can have its contents changed by this message. The example below is a request to an Acuvim-L series meter with the address of 17 to Preset Ep_imp = (17807783.3KWH), while its HEX value is 0A9D4089H. Ep_imp data address is 0156H and 0157H.

Table 4-10 Pre-set KWH Query Message

Addr	Fun	Data start reg HI	Data start reg LO	Data #of reg HI	Data #of reg LO	Byte Count
11H	10H	01H	56H	00H	02H	04H

Value HI	Value LO	Value HI	Value IO	CRC HI	CRC LO
0AH	9DH	40H	89H	4DH	B9H

Response

The normal response to a preset multi-register request includes the Acuvim-L series meter address, function code, data start register, the number of registers, and error checking.

Table 4-11 Preset KWH Query Message

Addr	Fun	Data start reg HI	Data start reg LO	Data #of reg HI	Data #of reg LO	CRC16 HI	CRC16 LO
11H	10H	01H	0CH	00H	02H	A2H	B4H

4.4 Ethernet Module (AXM Net)

4.4.1 Introduction to Ethernet

Ethernet was originally developed by Xerox and then developed further by Xerox, DEC, and Intel. Ethernet uses a Carrier Sense Multiple Access with Collision Detection (CSMA/CD) protocol, and provides transmission speeds up to 10 Mbps.

Now Ethernet stands for LAN with CSMA/CD protocol.

Ethernet is the most current communication standard in LAN. This standard defines the used type of cable and the method of Signal processing in LAN.

4.4.2 Function Description of Ethernet module

Please read appendix of technical data and specifications of Ethernet module before using.

* The Ethernet module supports Modbus-TCP protocol. It is used as a server, the default value of the protocol port is 502, and the user defined range of the protocol port is 2000~5999. The device address is the same as the meter.

* The Ethernet module supports SMTP protocol. It has an email function and supports “Send mail for timing” mode and “Send mail for event” mode.

* The Ethernet module supports HTTP protocol. It is used as an HTTP server, the default value of the protocol port is 80, and the scope of the protocol port is 6000~9999.

* The Ethernet module supports SNMP protocol. It is used as a SNMP agent, providing management to MIB library, so you can get data from the meter.

* The Ethernet module supports SNTP protocol. It can get update time to Coordinated Universal Time (UTC).

4.4.3 Appearance and Dimensions

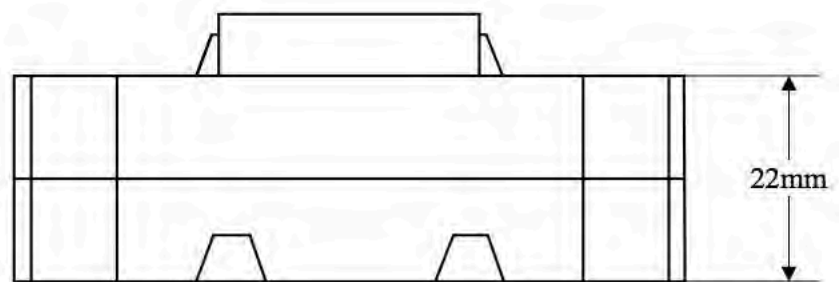

(Side View)

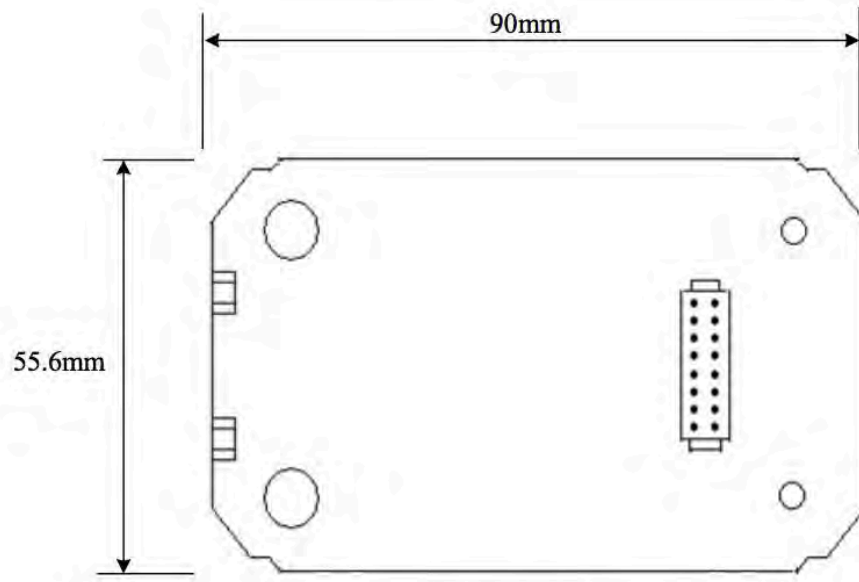

(Top View)

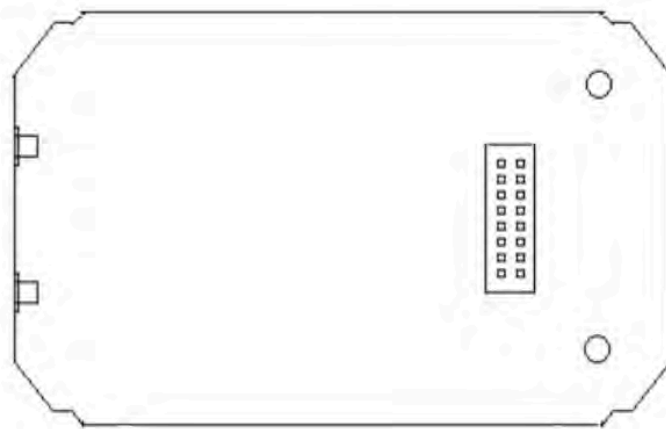

(Bottom View)

Fig. 4-1

4.4.4 Installation Method

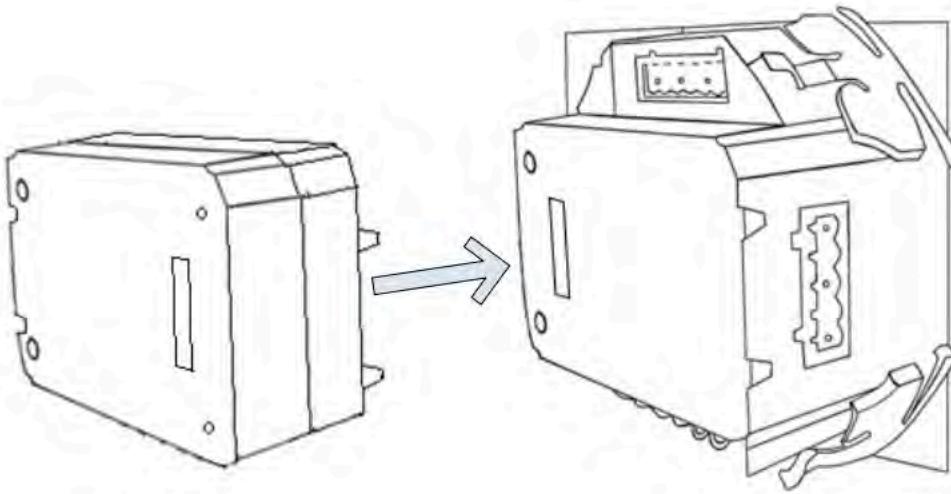

Fig. 4-2

The Ethernet module is linked to the Acuvim-L meter by a communication plug. It can also be linked to other extended modules like IO modules.

1. Insert the installation clips to the counterpart of the meter, and then press the Ethernet module lightly, so linking is established.
2. Tighten the installation screws.

Note:

1. Install Ethernet Module carefully to avoid damage;
2. Under no circumstances should any installation be done with the meter powered on. Failure to do so may result in injury or death.

4.4.5 Definition of RJ45 Interface

The Ethernet module uses a standard RJ45 connector to access the Ethernet network. The mechanical and electrical characteristics of the connectors comply with the requirements of IEC 603-7.

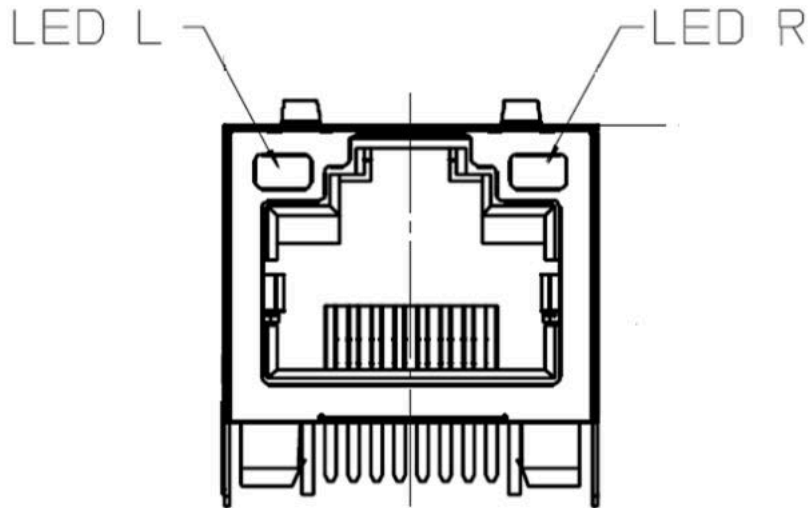

(Top View)
Fig. 4-3

Script	ID	Content
1	TX+	Transceiver Data+
2	TX-	Transceiver Data-
3	RX+	Receive Data+
4	n/c	Not connected
5	n/c	Not connected
6	RX-	Receive Data-
7	n/c	Not connected
8	n/c	Not connected

LED_L (yellow): displays speed status. LED on indicates 100Mbps, while LED off indicates 10Mbps.

LED_R (green): displays link and activity status combined. LED on indicates link status, while flashing LED indicates activity status. 4

4.4.6 Cable

Shielded twisted-pair cable (standard 568A or standard 568B) is usually recommended as reference to the EIA/TIA standard.

4.4.7 Connection Method

1. Direct Connect

The Ethernet module uses cross line (standard 568A) to connect to computers. The module supports Modbus-TCP, HTTP and SNMP functions for a direct connection.

2. Indirect Connect

The Ethernet module uses straight line (standard 568B) to access the Ethernet through a router or hub.

4.4.8 Initializing Ethernet Module

AXM-NET Module's default settings are as follows:

IP Address (192.168.1.254);

Subnet Mask (255.255.255.0);

Gateway (192.168.1.1);

This information can be found by using the keys on the meter front. The following process shows how to configure Ethernet module settings by using the front panel:



Fig. 4-4

1. Pressing “H” key and “V/A” key simultaneously on the meter will go to the meter parameter setting mode. Access Code page is the first page of “Setting” mode.



Fig. 4-5

2. Press “V/A” key to go to the device address page. It shows the Modbus address of the device.

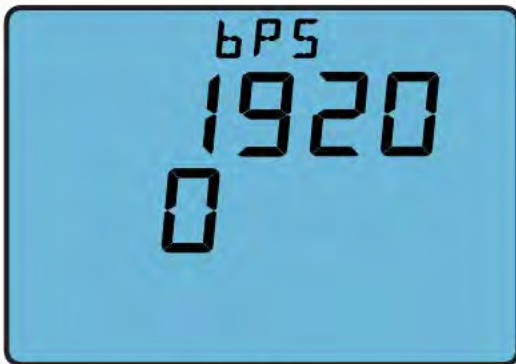

Fig. 4-6

3. Press “V/A” key to go to the baud rate setting page. Then press “H” key and “P” key simultaneously to go to the Ethernet module setting page.



Fig. 4-7

4. Set configuration mode in the first setting page. “1” means that users configure module settings with DHCP protocol while “0” means that users configure module settings with manual setting. Press “P” key or “E” key to select configuration mode, press “V/A” key to accept and go to the second setting page for IP Address.

Note: If you select the “1” mode, please go to step 12 directly and reset module. Wait until the reset is finished and find the new IP address in the following step.

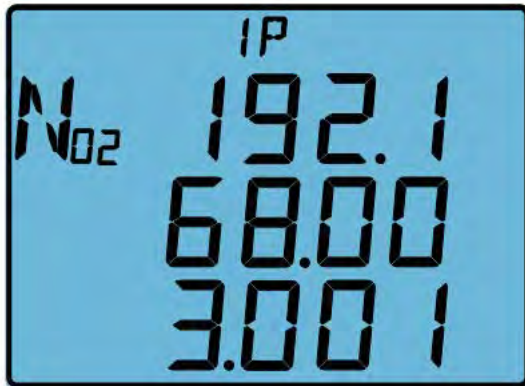

Fig. 4-8

5. Set IP Address in the second setting page, such as 192.168.3.1 as shown below. The cursor starts at the first digit. After setting the IP address, press the “V/A” key to accept and go to the third setting page for Subnet Mask.

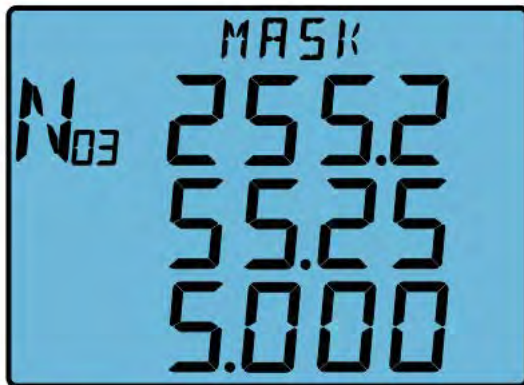

Fig. 4-9

6. Set Subnet Mask in the third setting page, such as 255.255.255.0. The cursor starts at the first digit. After setting the Subnet Mask, press the “V/A” key to accept and go to the fourth setting page for Gateway

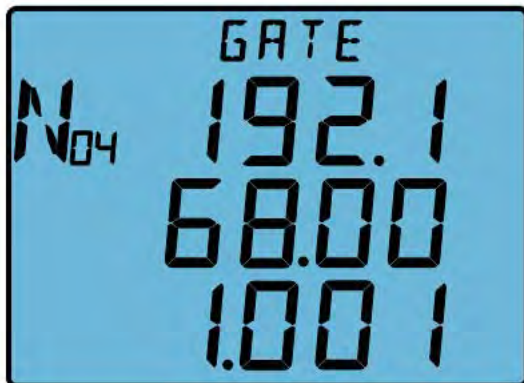

Fig. 4-10

7. Set Gateway in the fourth setting page, such as 192.168.1.1. The cursor starts at the first digit. After setting the Gateway, press the “V/A” key to accept and go to the fifth setting page for DNS Primary Server.



Fig. 4-11

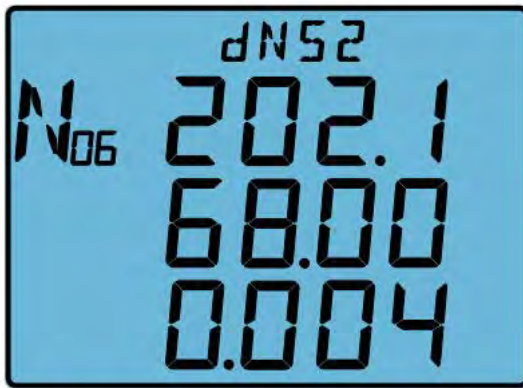

Fig. 4-12

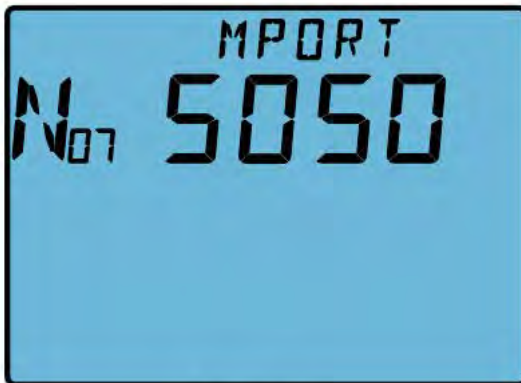

Fig. 4-13

8. Set DNS Primary Server in the fifth setting page, such as 202.168.0.1. The cursor starts at the first digit. After setting the DNS Primary Server, press the “V/A” key to accept and go to the sixth setting page for DNS Secondary Server. Note: the DNS parameters must be set correctly to use the SMTP functions.

9. Set DNS Secondary Server in the sixth setting page, such as 202.168.0.4. The cursor starts at the first digit. After setting the DNS Secondary Server, press the “V/A” key to accept and go to the seventh setting page for the Modbus-TCP port.

Note: the DNS parameters must be set correctly in order to use the SMTP functions.

10. Set Modbus-TCP port in the seventh setting page, such as 5050. The cursor starts at the first digit. After setting the Modbus-TCP port, press the “V/A” key to accept and go to the eighth setting page for the HTTP port. The Modbus-TCP port’s default value is 502, and the user defined range of port is 2000~5999. If the set port is not in the correct range, the set port will return to the default value.



Fig. 4-14



Fig. 4-15

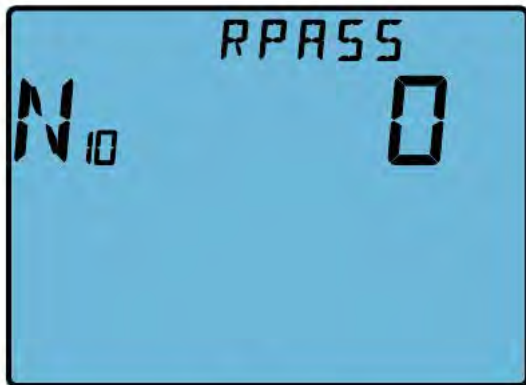

Fig. 4-16

11. Set HTTP port in the eighth setting page, such as 8080. The cursor starts at the first digit. After setting the HTTP port, press the “V/A” key to accept and go to the ninth setting page for the reset mode. The HTTP port’s default value is 80, and the user defined range of port is 6000~9999. If the set port is not in the correct range, the set port will return to the default value.

12. Set resetting mode in the ninth setting page. Selecting “0” will not reset the module. Select “1” to reset the module. Selecting “2” will load the module with default settings and reset module. Press the “P” key or “E” key to select the configuration mode. Press the “V/A” key to accept.

Note: When configuring Ethernet module settings completely, users must select “1” to restart module and new settings will take effect.

13. The password of AXM-NET module can be reset by selecting “1”. The password then becomes “12345678”. Selecting “0” means no change. Press “V/A” key to accept.

14. After configuring AXM-Net settings completely, press “H” key and “P” key simultaneously to return to the meter parameter setting mode.

4.4.9 Searching IP Address of Ethernet Module

The utility software of Acuvim-L series meter supports a meter search function. Users can use this function to obtain IP and MAC addresses of Ethernet Modules.

Operation steps:

- 1) Click “Start” menu of utility software.
- 2) Click “Search Device” menu.

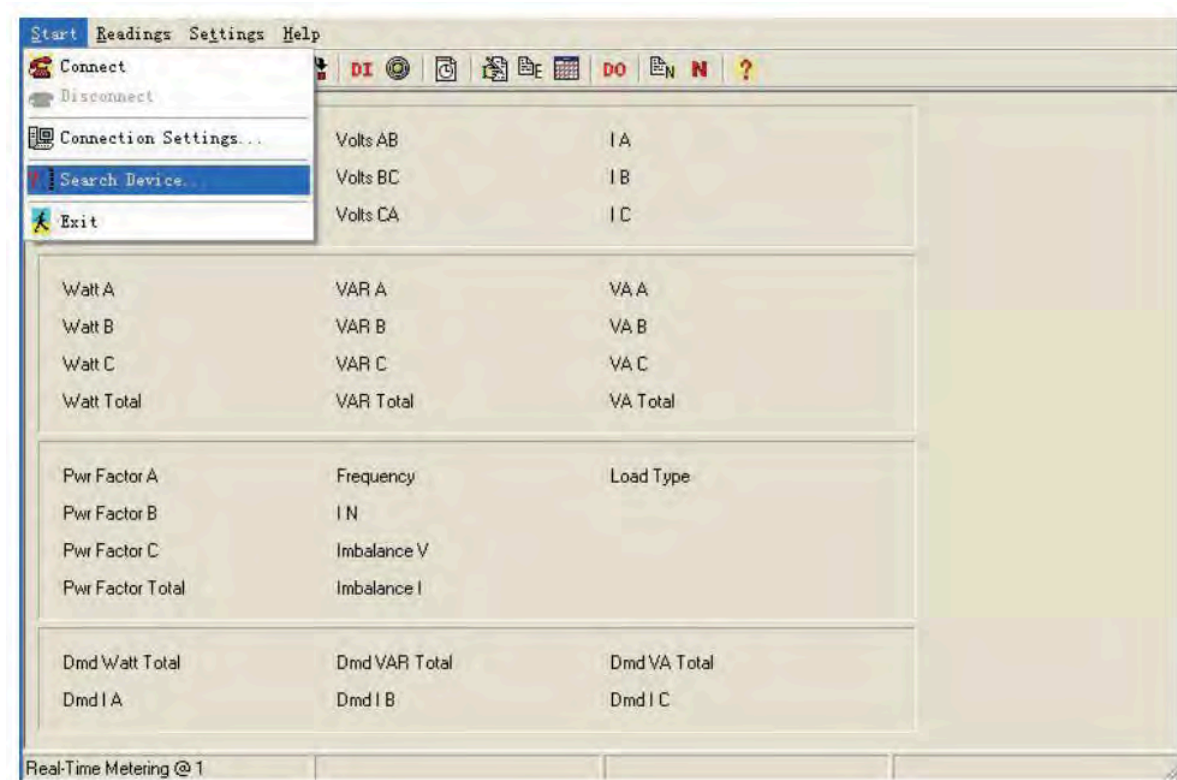

Fig. 4-17

3) Utility software pop-ups “Search Device(s)” window, and the window displays IP address, MAC address and all parameters of module.

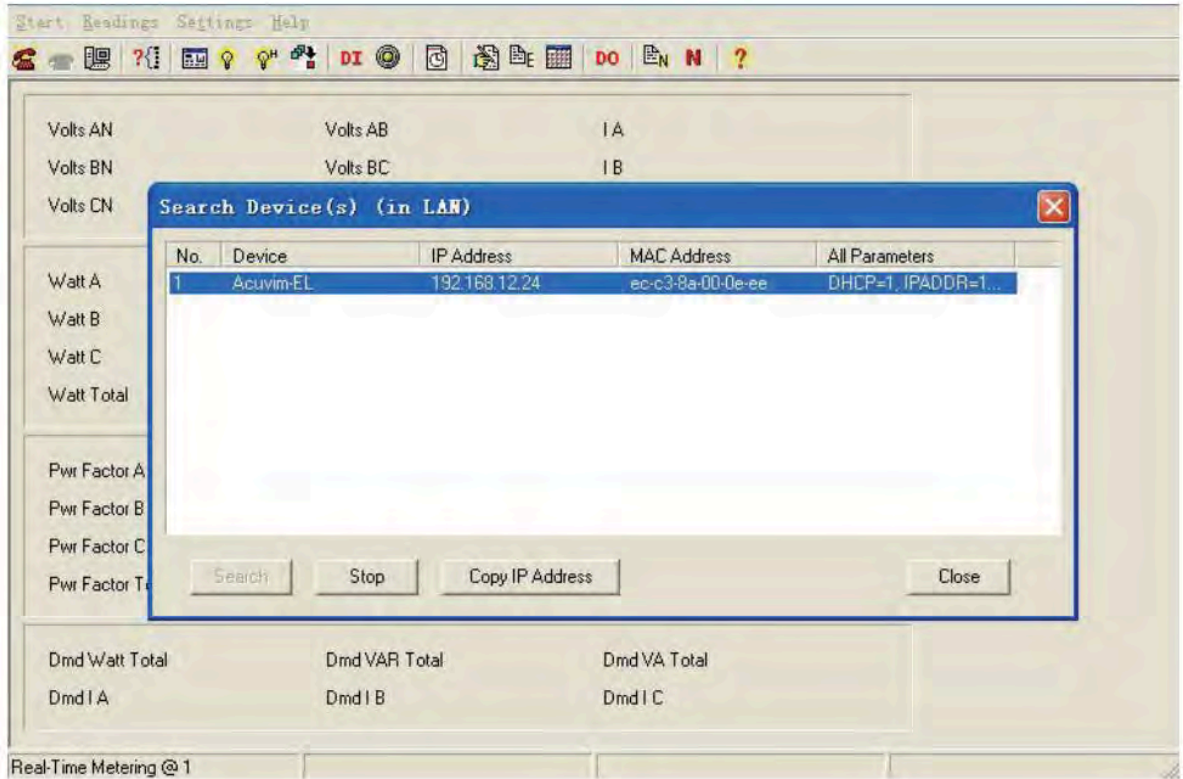

Fig. 4-18

Note: This function is used only in LAN, not used in WAN or direct connect to computer.

4.4.10 Description of Modbus-TCP protocol

The Modbus-TCP protocol is used for communication in Ethernet modules. The protocol sets up master/slave link in Ethernet. First, master device (client) sets up TCP link with slave device (server). Second, master device sends request frame to slave device, and slave device receives request frame and returns response frame to master device. Figure 4-19 displays working mode of Modbus-TCP protocol.

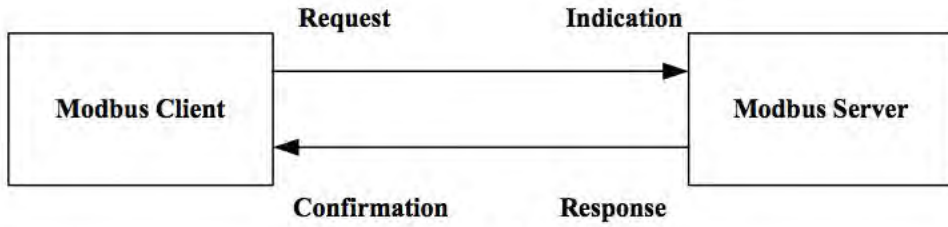

Fig. 4-19

1. Protocol

a. Data Frame Format

Table 4-12

MBAP Header	Function	Data
7x8-Bits	8-Bits	Nx8-Bits

b. Modbus Application Header (MBAP Header) Field

The Modbus application header field is the start of the data frame and consists of seven bytes.

Table 4-13

Field	Length	Description
Transaction Identifier	2 Bytes	Identification of a Modbus Request/Response transaction
Protocol Identifier	2 Bytes	Modbus protocol=0
Length	2 Bytes	Number of following bytes
Unit Identifier	1 Byte	Slave address, in the range of 0~247 decimal.

c. Function Field

The function code field of a message frame contains eight bits. Valid codes are in the range of 1~255 decimal. When a message is sent from a client to a server device the function code field tells the server what kind of action to perform.

Table 4-14

Code	Meaning	Action
01	Read Relay Output Status	Obtain current status of Relay Output
02	Read Digital Input (DI) Status	Obtain current status of Digital Input
03	Read Data	Obtain current binary value in one or more registers
05	Control Single Relay Output	Force Relay to a state of on or of
16	Write Multiple-registers	Place specific value into a series of consecutive multiple-registers

d. Data Field

The data field is constructed using sets of two hexadecimal digits, in the range of 00 to FF hexadecimal. The data field of messages sent from a master to slave devices contains additional information which the slave must use to take the action defined by the function code. This can include items like discrete and register addresses, the quantity of items to be handled, and the count of actual data bytes in the field. For example, if the master requests a slave to read a group of holding registers (function code 03), and the data field specifies the starting register and how many registers are to be read. If the master writes to a group of registers in the slave (function code 10 hexadecimal), the data field specifies the starting register, how many registers to write, the count of data bytes to follow in the data field, and the data to be written into the registers.

2. Format of communication

Explanation of frame

Table 4-15

Transaction identifier hi	Transaction identifier lo	Protocol identifier hi	Protocol identifier lo	Length hi	Length lo	Unit identifier
00H	00H	00H	00H	00H	06H	01H

Fun	Data start reg hi	Data start reg lo	Data #of regs hi	Data #of regs lo
03H	40H	00H	00H	48H

As shown in Table 5-4 the meaning of each abbreviated word is:

Transaction identifier hi: Transaction Identifier high byte

Transaction identifier lo: Transaction Identifier low byte

Protocol identifier hi: Protocol Identifier high byte

Protocol identifier lo: Protocol Identifier low byte

Length hi: length high byte

Length lo: length low byte

Unit identifier: slave address

Fun: function code

Data start reg hi: start register address high byte

Data start reg lo: start register address low byte

Data #of regs hi: number of register high byte

Data #of regs lo: number of register low byte

a. Read Status Relay (Function Code 01)

Function Code 01

This function code is used to read relay status in Acuvim-L series meter.

1=On 0=Off

There are 2 Relays in the meter, and the starting address is 0000H.

The following query is to read 2 Relays Status of the meter Address 1.

Query

Table 4-16 Read 2 Relays Status Query Message

Transaction identifier hi	Transaction identifier lo	Protocol identifier hi	Protocol identifier lo	Length hi	Length lo	Unit identifier
00H	00H	00H	00H	00H	06H	01H

Fun	Data start reg hi	Data start reg lo	Data #of regs hi	Data #of regs lo
01H	00H	00H	00H	02H

Response

The Acuvim-L series meter response includes MBAP Header, function code, quantity of data byte and the data. For example response to read the status of Relay 1 and Relay 2 is shown as Table 4-17. The status of Relay 1 and Relay 2 is responding to the last 2 bit of the data.

Table 4-17 Read 2 Relays Status Response Message

Relay 1: bit0

Relay 2: bit1

Transaction identifier hi	Transaction identifier lo	Protocol identifier hi	Protocol identifier lo	Length hi	Length lo	Unit identifier
00H	00H	00H	00H	00H	06H	01H

Fun	Data start reg hi	Data start reg lo	Data #of regs hi	Data #of regs lo
01H	00H	00H	00H	02H

The content of the data is,

7	6	5	4	3	2	1	0
0	0	0	0	0	0	1	0

MSB

LSB

(Relay 1 = OFF, Relay 2=ON)

b. Read Status of DI (Function Code 02)

Function Code 02

1=On 0=Off

There are 4 DIs in the meter, and the starting address is 0000H.

The following query is to read the 4 DIs Status of address 1 of Acuvim II series meter.

Query

Table 4-18 Read 4 DIs Query Message

Table 4-18 Read 4 DIs Query Message

Transaction identifier hi	Transaction identifier lo	Protocol identifier hi	Protocol identifier lo	Length hi	Length lo	Unit identifier
00H	00H	00H	00H	00H	06H	01H

Fun	Data start reg hi	Data start reg lo	Data #of regs hi	Data #of regs lo
02H	00H	00H	00H	04H

Response

The response includes MBAP Header, function code, quantity of data characters and the data characters.

An example response to read the status of 4 DIs (DI1=On, DI2=On, DI3=On, DI4= On) is shown as Table 4-19. The status of each is responding to the last 4 bit of the data.

Table 4-19 Read 4 DIs Response Message

DI1:bit0		DI1:bit1		DI1:bit2		DI1:bit3
Transaction identifier hi	Transaction identifier lo	Protocol identifier hi	Protocol identifier lo	Length hi	Length lo	Unit identifier
00H	00H	00H	00H	00H	06H	01H

Fun	Byte count	Data
02H	01H	0FH

The content of the data is,

7	6	5	4	3	2	1	0
0	0	0	0	0	0	1	0
MSB						LSB	

c. Read Data (Function Code 03)

Query

This function allows the users to obtain the measurement results of Acuvim II series meter.

Table 4-20 is an example of reading the 6 measured data (Time) from server device address 1, the data start address is 184H.

Table 4-20 Read Time Query Message

DI1:bit0		DI1:bit1		DI1:bit2		DI1:bit3
Transaction identifier hi	Transaction identifier lo	Protocol identifier hi	Protocol identifier lo	Length hi	Length lo	Unit identifier
00H	00H	00H	00H	00H	06H	01H

Fun	Data start reg hi	Data start reg lo	Data #of regs hi	Data #of regs lo
03H	01H	84H	00H	06H

Response

An example response to read Time (2006-12-18 14:15:20) is shown as Table 4-21.

Table 4-21 Read Response Message

DI1:bit0		DI1:bit1		DI1:bit2		DI1:bit3	
Transaction identifier hi	Transaction identifier lo	Protocol identifier hi	Protocol identifier lo	Length hi	Length lo	Unit identifier	
00H	00H	00H	00H	00H	06H	01H	

Fun	Byte count	Data 1 hi	Data 1 lo	Data 2 hi	Data 2 lo	Data 3 hi	Data 3 lo	Data 4 hi	Data 4 lo	Data 5 hi	Data 5 lo	Data 6 hi	Data 6 lo
03H	0CH	07H	D6H	00H	0CH	00H	12H	00H	0EH	00H	0FH	00H	14H

d. Control Relay (Function Code 05)

Query

The message forces a single Relay either on or off. Any Relay that exists within the Acuvim-L series meter can be forced to be either status (on or off). The address of Relay starts at 0000H, and the meter has two Relays.

The data value FF00H will set the Relay on and the value 0000H will turn it off; all other values are invalid and will not affect that relay.

The example below is a request to Acuvim-L series meter address 1 to turn on Relay 1.

Table 4-22 Control Relay Query Message

Transaction identifier hi	Transaction identifier lo	Protocol identifier hi	Protocol identifier lo	Length hi	Length lo	Unit identifier
00H	00H	00H	00H	00H	06H	01H

Fun	Data start reg hi	Data start reg lo	Value hi	Value lo
05H	00H	00H	FFH	00H

Response

The normal response to the command request is to retransmit the message as received after the Relay status has been altered.

Table 4-23 Control Relay Response Message

Transaction identifier hi	Transaction identifier lo	Protocol identifier hi	Protocol identifier lo	Length hi	Length lo	Unit identifier
00H	00H	00H	00H	00H	06H	01H

Fun	Data start reg hi	Data start reg lo	Value hi	Value lo
05H	00H	00H	FFH	00H

e. Preset/Reset Multi-Register (Function Code 16)

Query

Function code 16 allows the user to modify the contents of a Multi-Register. The example below is a request to an Acuvim-L series meter address 1 to Preset CT1 (500) and CT2 (5). CT1 data address is 108H, and CT2 data address is 109H.

Table 4-24 Preset CT Value Query Message

Transaction identifier hi	Transaction identifier lo	Protocol identifier hi	Protocol identifier lo	Length hi	Length lo	Unit identifier
00H	00H	00H	00H	00H	0BH	01H

Fun	Data start reg hi	Data start reg lo	Data #of regs hi	Data #of regs lo	Byte count	Value1 hi	Value1 lo	Value2 hi	Value2 lo
10H	01H	08H	00H	02H	04H	01H	F4H	00H	05H

Response

The normal response to a preset Multi-Register request includes MBAP Header, function code, data start register and the number of registers.

Table 4-25 Preset Multi-Registers Response Message

Transaction identifier hi	Transaction identifier lo	Protocol identifier hi	Protocol identifier lo	Length hi	Length lo	Unit identifier
00H	00H	00H	00H	00H	06H	01H

Fun	Data start reg hi	Data start reg lo	Data #of regs hi	Data #of regs lo
10H	01H	08H	00H	02H

Users may refer to the sixth chapter “Communication” and get the details of Acuvim-L series meter.

When using Modbus/TCP function, it is best to set the Scan interval of the software to under 1000 ms.

When using Third Party software, it is best to set Frame interval for the ModbusTCP function to under 1000 ms.

4.4.11 Webpage Browsing and Parameter Settings

The Ethernet module supports HTTP protocol and has a Web Server function making the Acuvim-L series meter accessible through Ethernet at anytime from anywhere.

The Ethernet module supports IE Browser 6.0 and higher editions and the Webpage Settings only support ASCII characters.

The IP address will be referred to as "192.168.1.200" for the remainder of this chapter.

1. Main page

Users enter the correct IP address and HTTP port of the module in the address bar of the web browser. This provides access to "Data", "Settings" and "Module Status".



Fig. 4-20

2. Module Status Webpage

By selecting the "Module Status" link, users can view the status and change the settings of the Ethernet module.

Device Description		Mail From	
DHCP Mode	AUTO	Mail to #1	
IP Address	192.168.12.24	Mail to #2	
Subnet Mask	255.255.255.128	Mail to #3	
Gateway	192.168.12.1	Subject	
DNS Primary	192.168.2.4	SMTP Server	
DNS Secondary	0.0.0.0	User Name	
MODBUS Port	502	Triggered Sending	disabled!
HTTP Port	80	Timed Sending	disabled!
MAC Address	ec-c3-8a-00-0e-ee	Mail Content	
Meter Model	Acuvim-EL	Meter SN	AL1234567
Meter Firmware	2.01	NET Firmware	1.01
Default Frequency	50Hz	Device Clock	2013-4-1-14-44-49

Fig. 4-21

3. Settings Webpage

By selecting the "Settings" link, users can access "Network Settings", "Mail Settings", "Webpage Settings", "Management" and "Password Setting".

When accessing the "Settings" link, users will be prompted to enter a password. The default password is 12345678.

a. "Password" Webpage

Figure 4-22: "Password" webpage. If the password is valid, the browser will go to the "Network Settings" webpage. If an incorrect password is used, users will be notified of "Invalid Password".

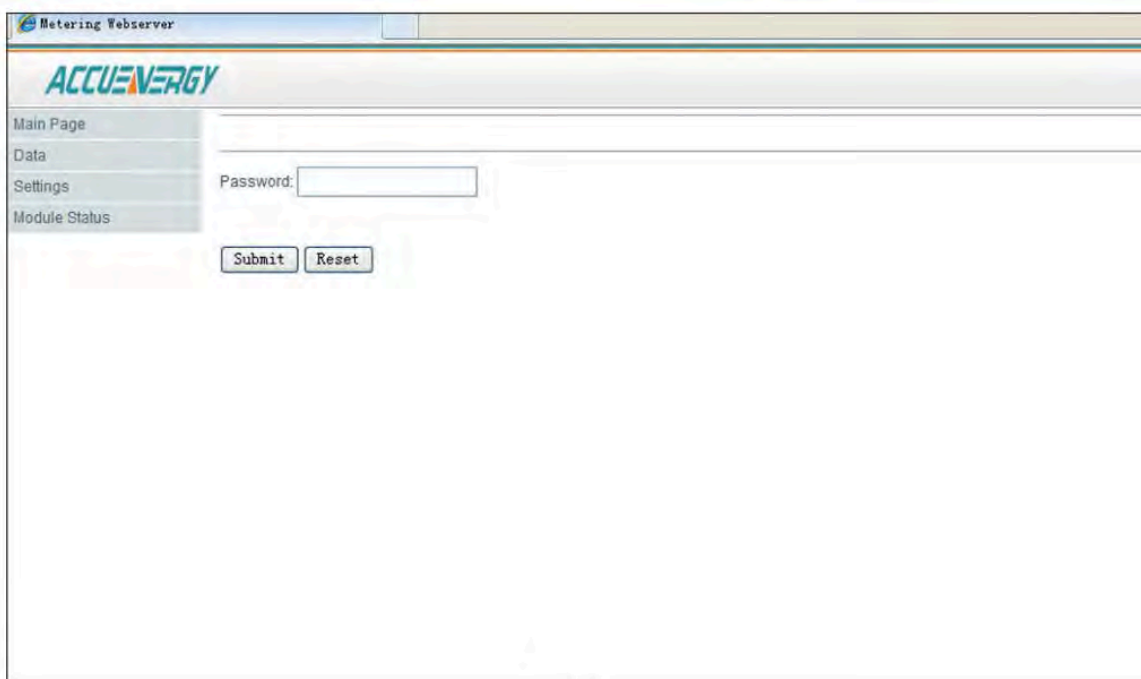

Fig. 4-22

b. “Network Settings”

Webpage Figure 4-23: “Network Settings” webpage. There are two sections for you to set: Ethernet setting and SNTP setting. In Ethernet setting section, It supports two network setting modes: Manual or Auto. There are two port settings: HTTP port and Modbus-TCP port.

The default value of Modbus-TCP port is 502, and the user defined range is 2000~5999. The default value of HTTP port is 80, and the user defined range is 6000~9999.

In SNTP setting section, there are four contents:

- SNTP Enable, enable SNTP function.
- SNTP Interval, setup interval seconds which SNTP client check SNTP server. The default value is 10min, and the user defined range is 1-60000min.
- SNTP Server, setup SNTP Server which SNTP client update from. Please find available SNTP server from internet.
- Time Zone Selecting: select Time Zone which match your location.

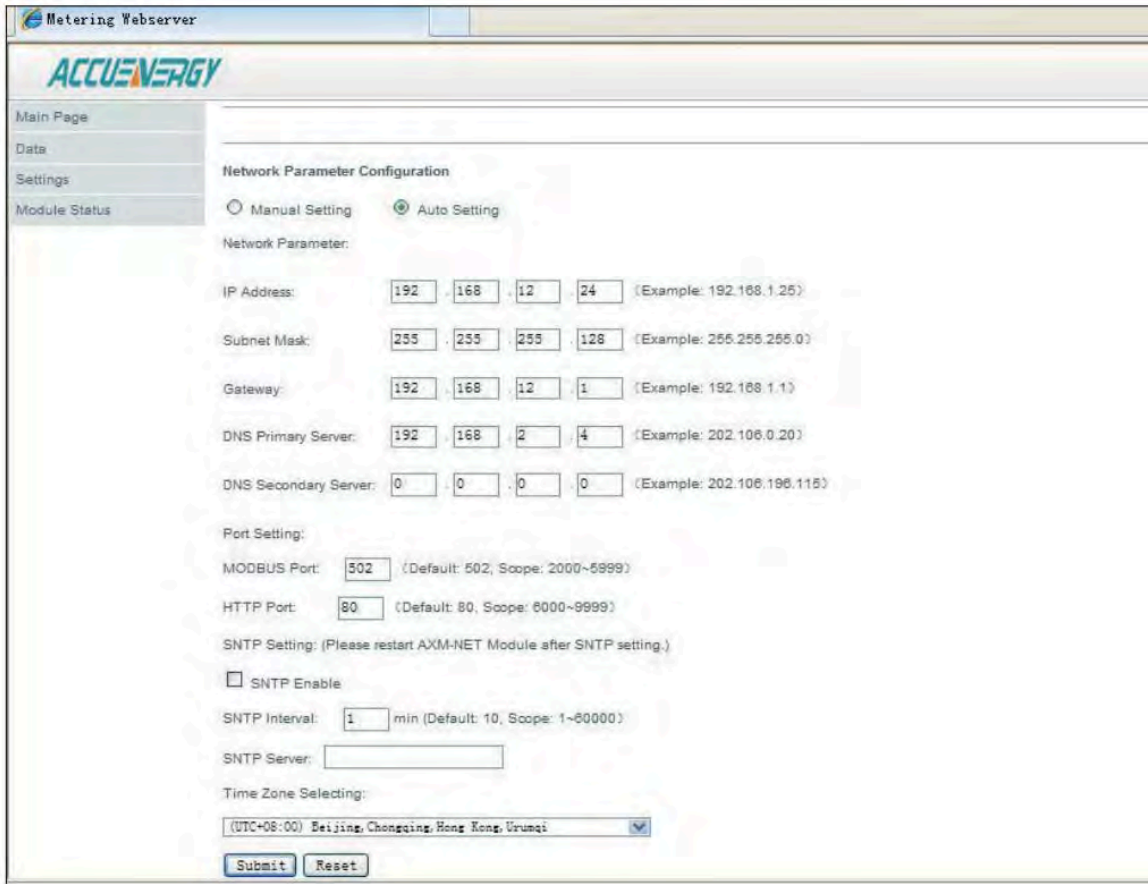

Fig. 4-23

c. “Mail Settings” Webpage

Figure 4-24: “Mail Settings” webpage. Users can choose between 4 mail sending modes: "Triggerd Sending", "Timed Sending", both "Triggered and Timed Sending" and "None". Boxes marked with "*" cannot be left blank. "Triggered Sending" means users will receive mail when the meter detects a new event, such as an "SOE Event". "Timed Sending" means users can receive mail every 5~1440 minutes (user settable) reporting "Metering", "Energy", "Harmonics", "Max/Min" and "SOE Record".

Sending Modes can be set as follows:

Setting "Triggered Sending" mode: users can select "SOE Event" as seen in Figure 4-24. Triggered Sending mode is disabled if "SOE Event" is not selected.

Setting "Timed Sending" mode: users enter a number between 5 and 1440 minutes into the box beside "Timed Sending". This number is the interval time between mail. Sending mode is disabled if 0 is entered. Users can also select which parameters to receive reports on by checking the checkboxes below "Timed Sending" in Figure 4-24. Setting both "Triggered Sending" and "Timed Sending" mode: users follow the steps for both "Triggered Sending" and "Timed Sending" above.

"None" mode: users disable both "Triggered Sending" and "Timed Sending" modes.

Note: Mail Server part includes "SMTP Server", "User Name" and "Password". For the "SMTP Server" users can input either domain name such as "mail.accuenergy.com" or an IP address such as "222.128.6.73" which is from "mail.accuenergy.com" resolved. A user name and password will be required to log in.

The screenshot shows the 'Metering Webserver' interface with the 'Settings' tab selected. The 'Mail Information' section includes input fields for 'Mail From', 'Mail To #1', 'Mail To #2', 'Mail To #3', and 'Subject'. The 'Mail Server' section includes input fields for 'SMTP Server', 'User Name', and 'Password'. The 'Mail Content' section has a 'Triggered Sending' section with a checkbox for 'SOE Event' and a 'Timed Sending' section with a text input field for minutes and checkboxes for 'Metering', 'Energy', 'Harmonics', 'Max and Min', and 'SOE Record'. 'Submit' and 'Reset' buttons are at the bottom.

Fig. 4-24

d. "Web Configuration Settings" Webpage

Figure 4-25: "Webpage Settings" page. Users set the "Device Description" according to the meter type.

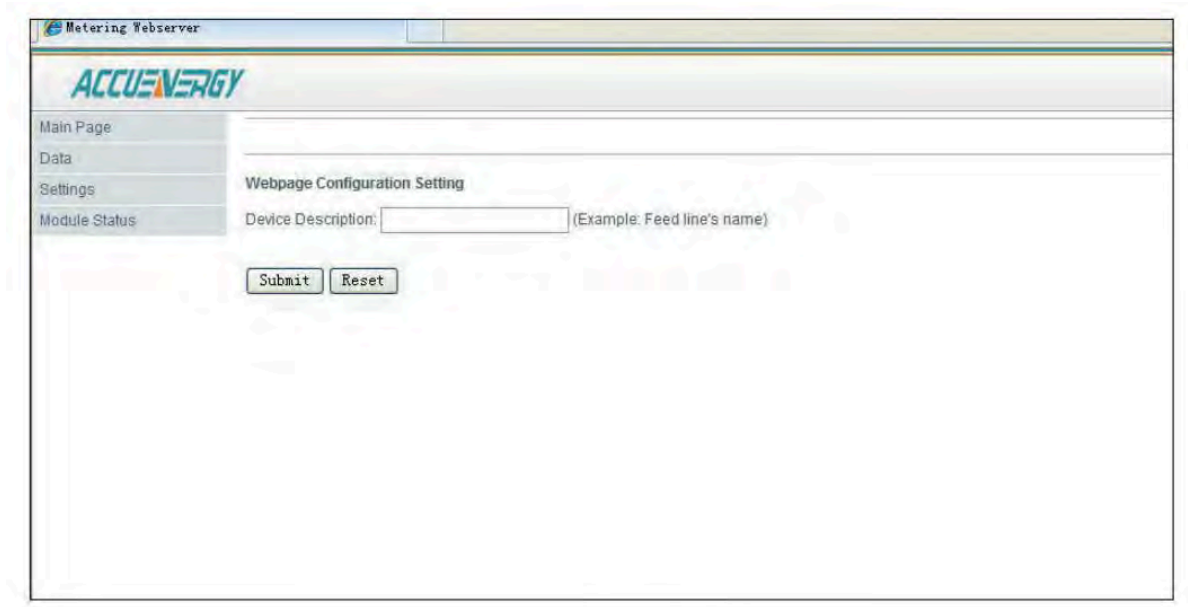

Fig. 4-25

e. "Management" webpage

Figure 4-26: "Management" webpage. Users can easily update the software online by selecting the updated file, which can be got from Accuenergy Corporation. The "Reboot NET module" option resets the module itself.

IP Address:192.168.1.254

Subnet Mask:255.255.255.0

Gateway:192.168.1.1

DNS Primary: 202.106.0.20

DNS Secondary: 202.106.196.115

MODBUS Port: 502

HTTP Port: 80



Fig. 4-26

f. “Password Setting” Webpage

Figure 4-27: “Password Setting” webpage. To change the password, users need to input the current password first.

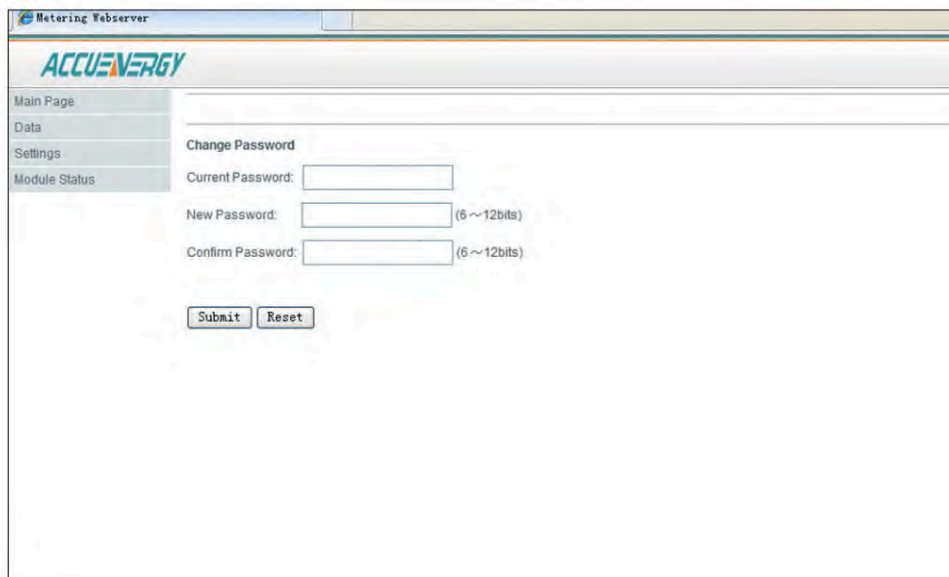

Fig. 4-27

4. Data Webpage

Click "Data" Link to Visit Data webpages. There are six kinds of data webpages. They are "Metering" webpage, "Energy" webpage, "Harmonics" webpage, "Max and Min" webpage, "SOE Record" webpage and "IO Status" webpage. Each webpage shows the working status of the meter.

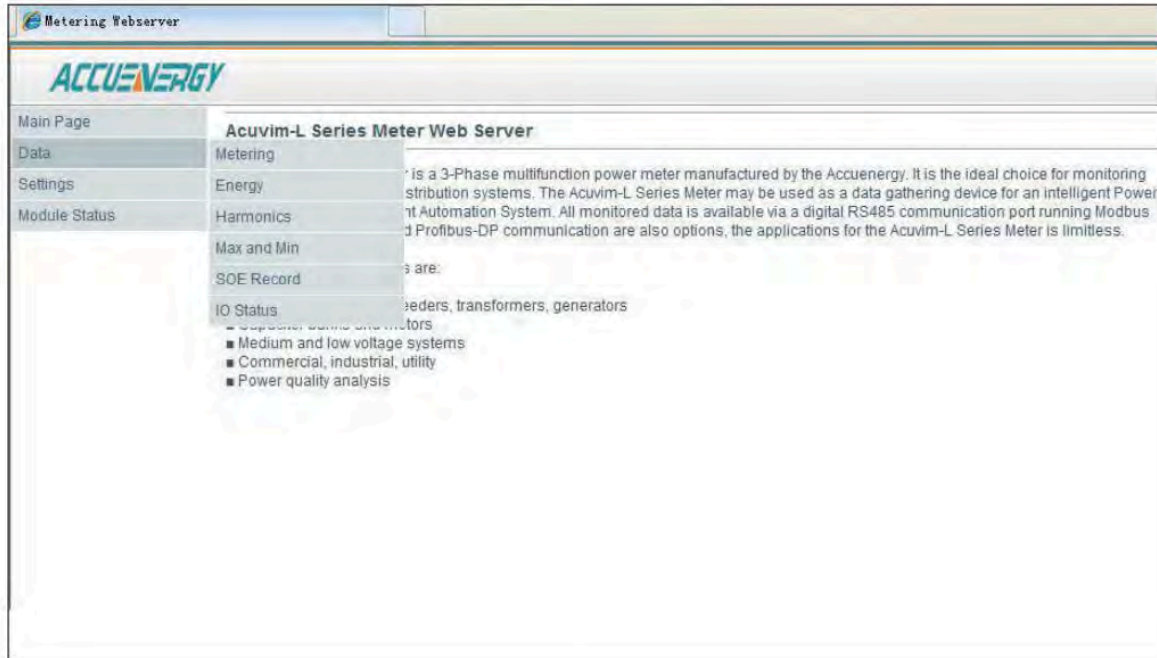

Fig. 4-28

"Metering" webpage includes the data of real-time parameters for Acuvim-L series meter. There are thirty-six parameters, such as Volts AN, I A, Watt A.

"Energy" webpage includes the energy data for Acuvim-L series meter. There are five parameters, such as Delivered kWh, kVAh.

"Harmonics" webpage includes harmonics parameters for Acuvim-L series meter, such as THD Volts Average.

"Max and Min" webpage includes the max and min data of parameters for Acuvim-L series meter. There are fifteen parameters, such as Volts AN, I A , and Watt Total (Demand).

"SOE Record" webpage includes SOE record for Acuvim-L series meter. There are twenty records. Each record includes Time Stamp and DI Status.

"IO Status" webpage includes DI status or DI counters.

4.4.12 Email Function

The Ethernet module supports SMTP protocol, which provides email capabilities. Before sending emails, users must set their own DNS Server. Please refer to "Network settings" which includes DNS Server setting.

Please note, as per 3.c of Section 4.4.11, there are three modes users can select. The first is "Triggered Sending", which means once new events happen, users can receive email notifications immediately. The second is "Timed Sending" mode. Users can receive emails based on pre-set time intervals (5~1440 minutes), which include all information on "Data" webpage.

The third mode is a combination of "Triggered Sending" and "Timed Sending".

4.4.13 SNMP Function

Ethernet communication supports SNMP (Simple Network Management Protocol) protocol, so you can get data from the meter through SNMP, by get, get-next, and walk instructions. To master this manual, you supposed to be familiar with SNMP protocol, and you have generously mastered the function and application of this product.

We will show you an example of how to use SNMP server software to get data from the meter. The example is showed by MG-SOFT MIB Browser Professional SNMPv1/v2c Edition 2010.

NOTE: MG-SOFT MIB Browser Professional is the production of MG-SOFT Corporation, and its copyrights are reserved by MG-SOFT Corporation. We will not supply MG-SOFT MIB Browser Professional with our meters.

1. Compile MIB

After installed MG-SOFT MIB Browser Professional, you can load AcuvimL.mib file by MIB Compiler, which is one part of MG-SOFT MIB Browser Professional.

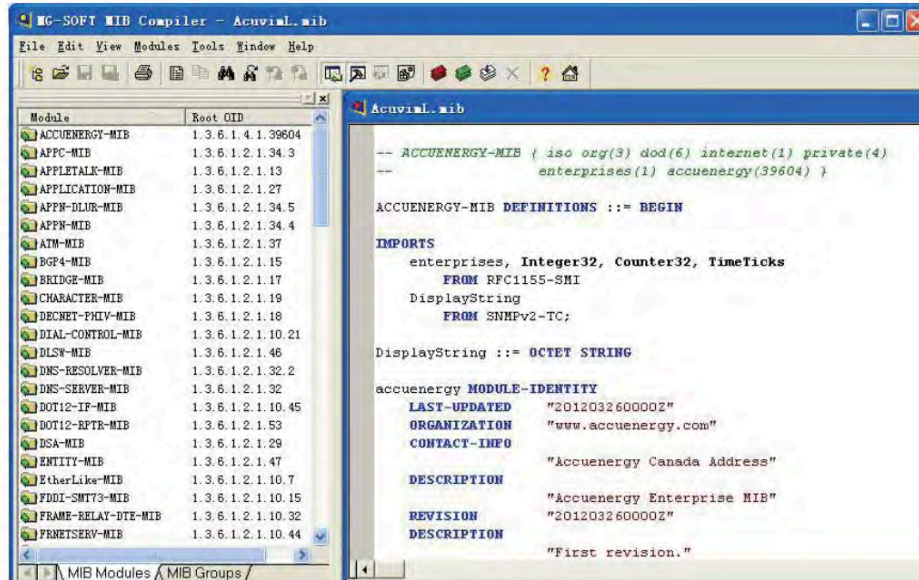

Fig. 4-29

Using F7 on keyboard to compile this MIB, then select ACCUENERGY-MIB, select Save.

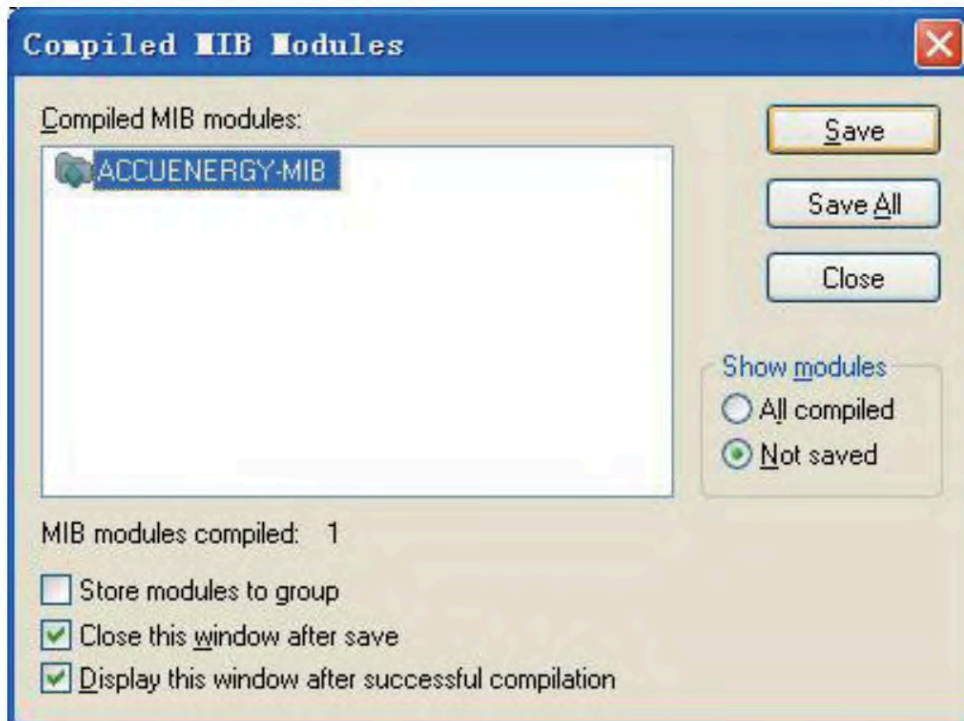

Fig. 4-30

After successfully adding Acuvim-L MIB, there should show ACCUENERGY-MIB in MIB Modules, which OID is 1.3.6.1.4.1.39604.

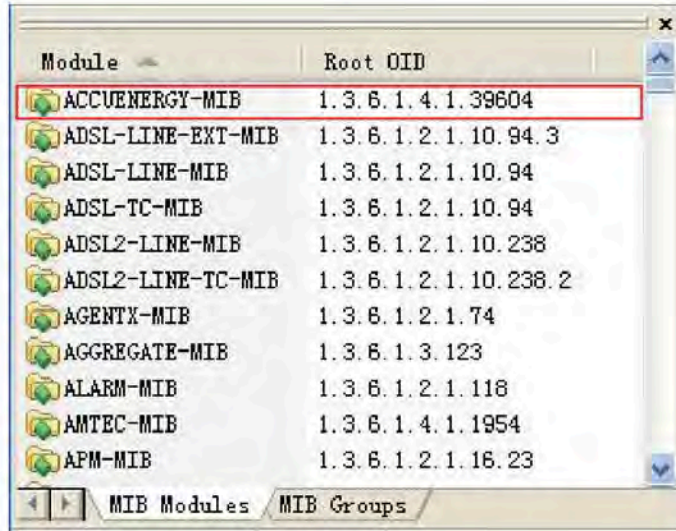

Fig. 4-31

2. Load ACCUENERGY-MIB

Opening MIB Browser, which is part of MG-SOFT, select MIB Table, then load ACCUENERGY-MIB from MIB Modules, unload unnecessary MIBs from Loaded MIB modules.

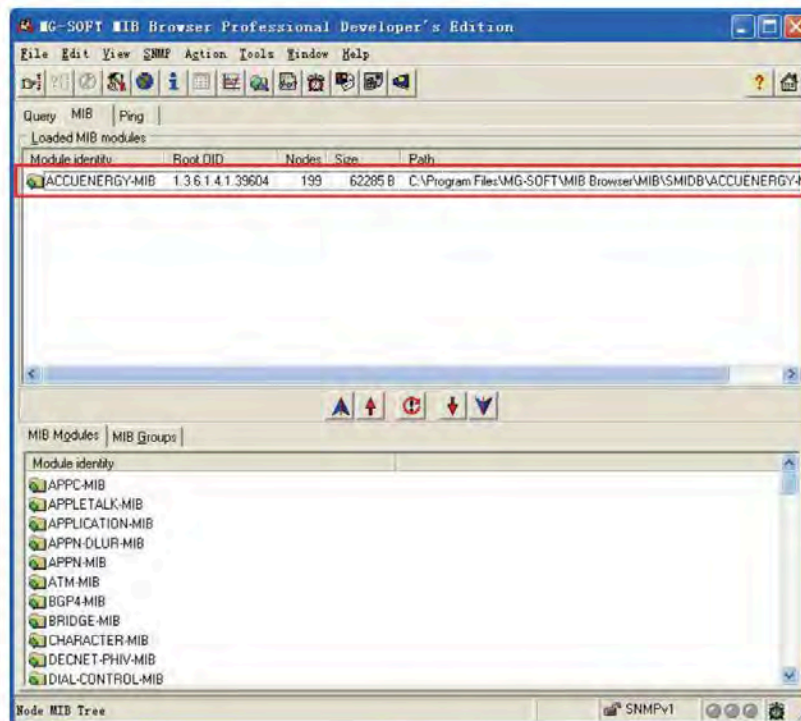

Fig. 4-32

3. Contact SNMP Agent

Change to Query Label, input IP address under Remote SNMP agent, such as 192.168.1.249, select Contact button, if the SNMP agent works on this IP, it will return like this,

Remote address: 192.168.1.249 port: 161 transport: IP/UDP

Local address: 192.168.1.126 port: 3592 transport: IP/UDP

Protocol version: SNMPv1

1: [Loaded: RFC-1215] sysUpTime.0 (timeticks) 0 days 20h:11m:50s.23th (7271023)

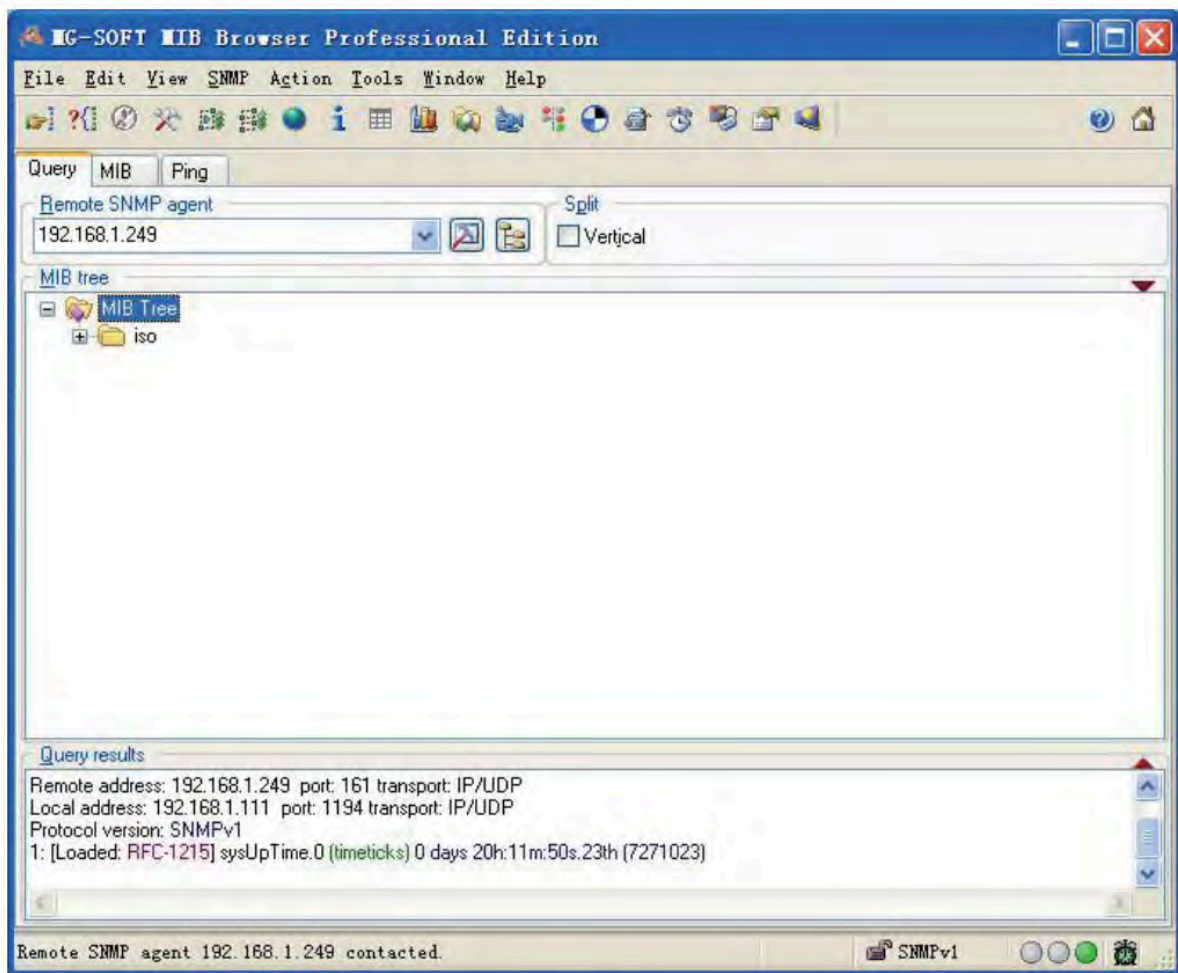



Fig. 4-33

4. Walk the MIB

Right Click on the tree root, then expand MIB, find acuvimL OID, right click to select walk , then query whole acuvimL MIB.

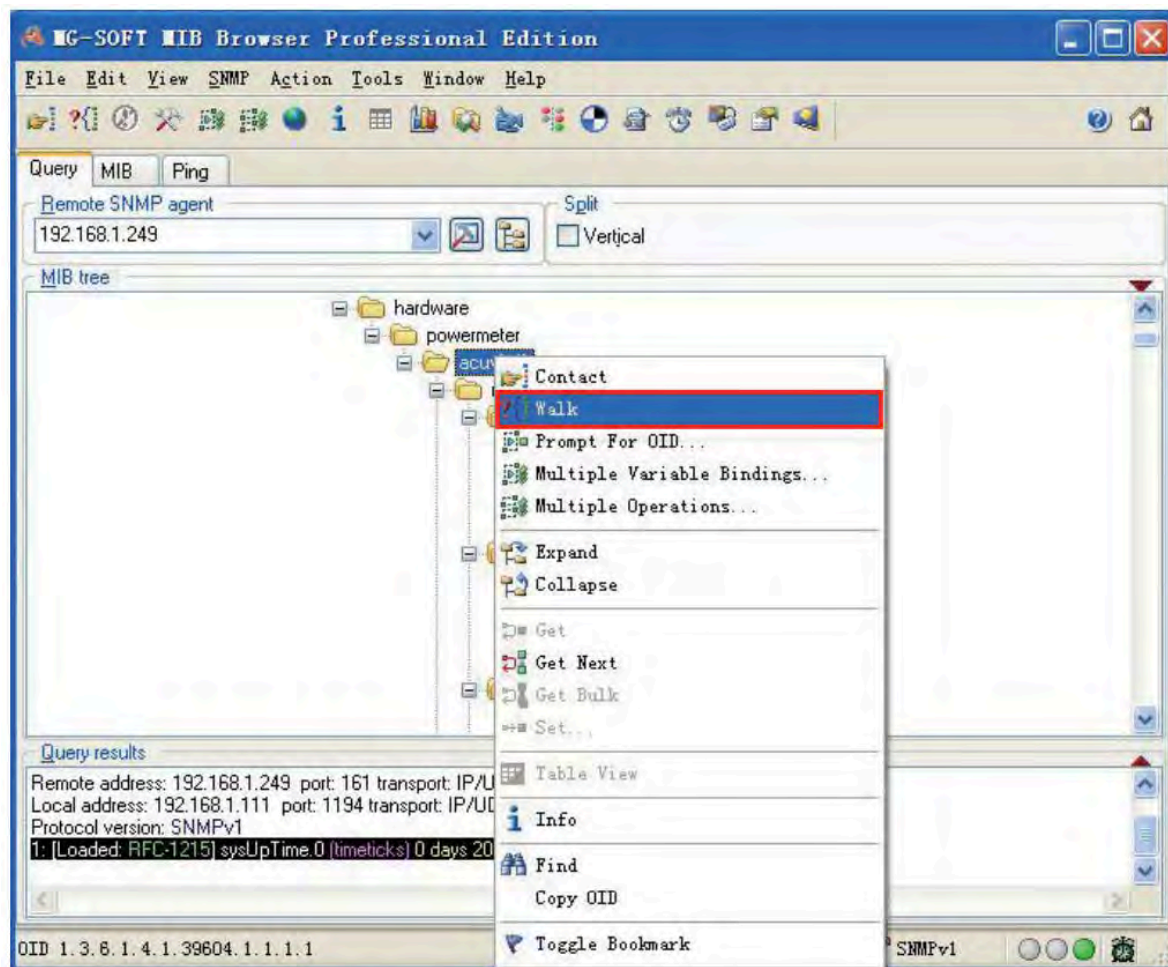

Fig. 4-34

QUERY returns like these,

***** SNMP QUERY STARTED *****

1: phaseVoltageA.0 (integer) 0

2: phaseVoltageB.0 (integer) 0
3: phaseVoltageC.0 (integer) 0
4: lineVoltageAB.0 (integer) 0
5: lineVoltageBC.0 (integer) 0
.....
161: lastMonthEqExpNormal.0 (integer) 328
162: lastMonthEsNormal.0 (integer) 9771
163: lastMonthEpImpSum.0 (integer) 365020
164: lastMonthEpExpSum.0 (integer) 11864
165: lastMonthEqImpSum.0 (integer) 352534
166: lastMonthEqExpSum.0 (integer) 17539
167: lastMonthEsSum.0 (integer) 901432
***** SNMP QUERY FINISHED *****

5. Get a value

Right Click on one MIB OID, which you want to query, then select Get, and then return the OID value.

For example, the followings demonstrate the result of getting the value of phase Voltage A.

Operation: Get Request binding:

1: phaseVoltageA.0 (null) null
1: phaseVoltageA.0 (null) null

Response binding:

1: phaseVoltageA.0 (integer) 0

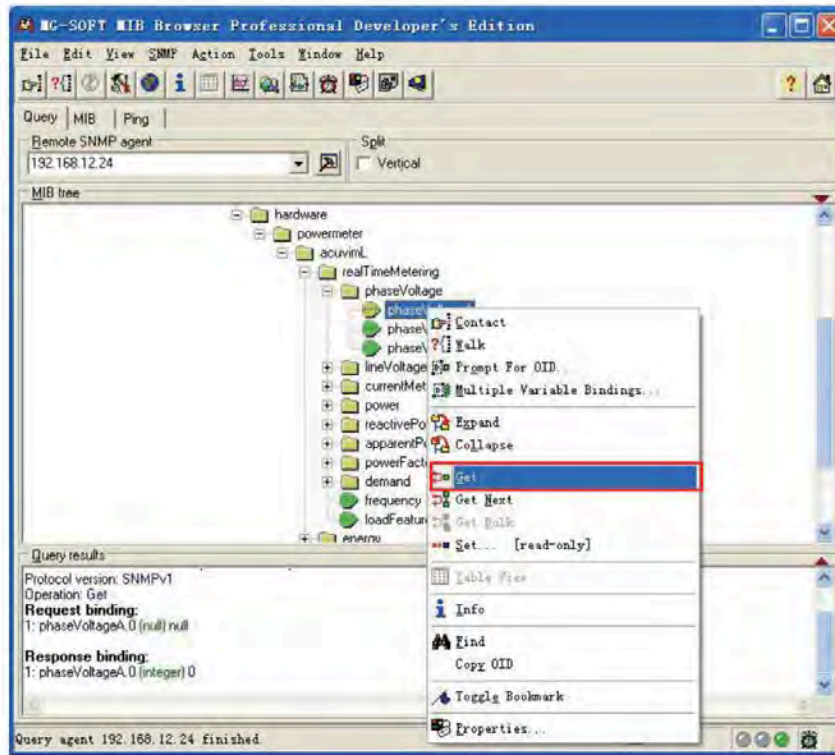

Fig. 4-35

4.4.14 SNTP Function

Ethernet communication supports SNTP (Simple Network Time Protocol) protocol, so meters can get update time to Coordinated Universal Time (UTC). Please find the SNTP Settings – Network Settings by Internet Explorer,



Fig. 4-36

4.5 Data Address Table

Basic measurements

The data address of basis measurements includes primary data address and secondary data address. Function code: 03 read.

Table 4-26 secondary data address of basic measurement

Address	Parameters	Range	Data Type	Type of access
130H	Frequency F	4500~6500	word	R
131H	Phase voltage V1	0~65535	word	R
132H	Phase voltage V2	0~65535	word	R
133H	Phase voltage V3	0~65535	word	R
134H	Line voltage V12	0~65535	word	R
135H	Line voltage V23	0~65535	word	R
136H	Line voltage V31	0~65535	word	R
137H	Phase(line)current I1	0~65535	word	R
138H	Phase(line)current I2	0~65535	word	R
139H	Phase(line)current I3	0~65535	word	R
13AH	Neutral line current In	0~65535	word	R
13BH	Phase power Pa	-32768~32767	Integer	R
13CH	Phase power Pb	-32768~32767	Integer	R
13DH	Phase power Pc	-32768~32767	Integer	R
13EH	System power Psum	-32768~32767	Integer	R
13FH	Phase reactive power Qa	-32768~32767	Integer	R
140H	Phase reactive power Qa	-32768~32767	Integer	R
141H	Phase reactive power Qb	-32768~32767	Integer	R
142H	System reactive power	-32768~32767	Integer	R
143H	System apparent power	0~65535	word	R
144H	Phase power factor PFa	-1000~1000	Integer	R
145H	Phase power factor PFb	-1000~1000	Integer	R
146H	Phase power factor PFc	-1000~1000	Integer	R
147H	System power factor	-1000~1000	Integer	R
148H	Voltage unbalance factor	0~1000	word	R
149H	Current unbalance factor	0~1000	word	R
14AH	Load nature RT (L/C/R)	76/67/82	word	R
14BH	Phase apparent power Sa	-32768~32767	Integer	R
14CH	Phase apparent power Sb	-32768~32767	Integer	R
14DH	Phase apparent power Sc	-32768~32767	Integer	R

14EH	reserved	---	---	---
14FH	Apparent power demand	-32768~32767	Integer	R
150H	Power demand P_Dmd	-32768~32767	Integer	R
151H	Reactive power demand	-32768~32767	Integer	R
152H	Phase A current demand	0~65535	word	R
153H	Phase B current demand	0~65535	word	R
154H	Phase C current demand	0~65535	word	R
155H	reserved	0	---	R

The relationship between numerical value in register of the Acuvim-L series meter and the real physical value is shown in the following table. (Rx is numerical value in register of the Acuvim-L series meter)

Table 4-27 Conversion relationship of basic measurements

Parameters	Relationship	Unit
Voltage V1,V2,V3,V12,V23,V31	$U=R_x \times (PT1 / PT2) / 10$	Volt(V)
Current I1,I2,I3, In	$I=R_x \times (CT1/CT2) / 1000$	Amp(A)
Power Pa, Pb, Pc, Psum	$P=R_x \times (PT1 / PT2) \times (CT1/ CT2)$	Watt(W)
Reactive power Qa, Qb, Qc, Qsum	$Q=R_x \times (PT1 / PT2) \times (CT1/ CT2)$	var
Apparent power Sa,Sb,Sc,Ssum	$S=R_x \times (PT1 / PT2) \times (CT1/ CT2)$	VA
Power factor PFa, PFb, Pfc, PFsum	$PF=R_x / 1000$	NA
Frequency	$F=R_x / 100$	Hz
Load nature (R/L/C)	76/67/82	NA
Voltage or current unbalance factor U_unbl, I_unbl	$Unbl=(R_x/1000) \times 100\%$	NA

If the CT2=333; Actually, it is Mapped to 1;

Table 4-28 Primary data address of basic measurements

Address	Parameters	Data Type	Type or Access
0600H~0601H	Frequency F	Float	R
0602H~0603H	Phase voltage V1	Float	R
0604H~0605H	Phase voltage V2	Float	R
0606H~0607H	Phase voltage V3	Float	R
0608H~0609H	Line voltage V12	Float	R
060AH~060BH	Line voltage V23	Float	R
060CH~060DH	Line voltage V31	Float	R
060EH~060FH	Phase (line) current I1	Float	R
0610H~0611H	Phase (line) current I2	Float	R
0612H~0613H	Phase (line) current I3	Float	R
0614H~0615H	Neutral line current In	Float	R
0616H~0617H	Phase power Pa	Float	R
0618H~0619H	Phase power Pb	Float	R
061AH~061BH	Phase power Pc	Float	R
061CH~061DH	System power Psum	Float	R
061EH~061FH	Phase reactive power Qa	Float	R
0620H~0621H	Phase reactive power Qb	Float	R
0622H~0623H	Phase reactive power Qc	Float	R
0624H~0625H	System reactive power	Float	R
0626H~0627H	System apparent Ssum	Float	R
0628H~0629H	Phase power factor PFa	Float	R
062AH~062BH	Phase power factor PFb	Float	R
062CH~062DH	Phase power factor PFc	Float	R
062EH~062FH	System power PFsum	Float	R
0630H~0631H	Voltage unbalance factor	Float	R
0632H~0633H	Current unbalance factor	Float	R
0634H~0635H	Reserved	Float	R
0636H~0637H	Phase apparent power Sa	Float	R
0638H~0639H	Phase apparent power Sb	Float	R
063AH~063BH	Phase apparent power Sc	Float	R
063CH~063DH	Reserved	Float	R
063EH~063FH	Apparent power demand	Float	R
0640H~0641H	Power demand P_Dmd	Float	R
0642H~0643H	Reactive power demand	Float	R
0644H~0645H	Phase A current demand	Float	R
0646H~0647H	Phase A current demand	Float	R
0648H~0649H	Phase C current demand	Float	R
064AH~064BH	Reserved	Float	R

Power quality measurements (Function code: 03 read)

The energy parameter address list please refer to Table 4-16.

Table 4-29 Data table of Power quality measurements

Address	Parameters	Data Range	Data Type	Type of access
400H	Total harmonic distortion of V1 or V12 THD_V1	0~10000	word	R
401H	Total harmonic distortion of V2 or V23 THD_V2	0~10000	word	R
402H	Total harmonic distortion of V3 or V31 THD_V3	0~10000	word	R
403H	Total harmonic distortion of I1 THD_I1	0~10000	word	R
404H	Total harmonic distortion of I2 THD_I2	0~10000	word	R
405H	Total harmonic distortion of I3 THD_I3	0~10000	word	R
406H~423H	Harmonic content of V1 or V12 (2nd~31th)	0~10000	word	R
424H~441H	Harmonic content of V2 or V23 (2nd ~31th)	0~10000	word	R
442H~45FH	Harmonic content of V3 or V31 (2nd ~31th)	0~10000	word	R
460H~47DH	Harmonic content of I1 (2nd ~31th)	0~10000	word	R
47EH~49BH	Harmonic content of I2 (2nd ~31th)	0~10000	word	R
49CH~4B9H	Harmonic content of I3 (2nd ~31th)	0~10000	word	R

The relationship between numerical value in register of Acuvim-L and the real physical value is as following table. (Rx is numerical value in register of Acuvim-L)

Table 4-31 Conversion relationship of Power quality measurements

Parameter	Relationship	Unit
THD	$THD = Rx / 10000 \times 100\%$	NA
Harmonic content	$THD_n = Rx / 10000 \times 100\%$	NA

Statistics measurements

Function code: 03 read

Acuvim-L no most value statistics.

Table 4-32 data address of Statistics measurements

Address	Parameters	Data Range	Data Type	Type of access
1000H~1003H	Max of V1 V1_max(format: value/ yy mm/dd hh/mm ss)	0~65535	word	R
1004H~1007H	Max of V2 V2_MAX and time	0~65535	word	R
1008H~100BH	Max of V3 V3_MAX and time	0~65535	word	R
100CH~100FH	Max of V12 V12_MAX and time	0~65535	word	R
1010H~1013H	Max of V23 V23_MAX and time	0~65535	word	R
1014H~1017H	Max of V31 V31_MAX and time	0~65535	word	R
1018H~101BH	Max of I1 I1_MAX and time	0~65535	word	R
101CH~101FH	Max of I2 I2_MAX and time	0~65535	word	R
1020H~1023H	Max of I3 I3_MAX and time	0~65535	word	R
1024H~1027H	Max of power demand PDmd_MAX and	-32768~32767	integer	R
1028H~102BH	Max of reactive power demand QDmd_MAX	-32768~32767	integer	R
102CH~102FH	Max of current demand Ia IaDmd_MAX	0~65535	word	R
1030H~1033H	Max of current demand Ib IbDmd_MAX	0~65535	word	R
1034H~1037H	Max of current demand Ic IcDmd_MAX	0~65535	word	R
1038H~103BH	Max of apparent power demand SDmd_MAX	0~65535	word	R
103CH~103FH	Min of V1 V1_MIN and time	0~65535	word	R
1040H~1043H	Min of V2 V2_MIN and time	0~65535	word	R
1044H~1047H	Min of V3 V3_MIN and time	0~65535	word	R
1048H~104BH	Min of V12 V12_MIN and time	0~65535	word	R
104CH~104FH	Min of V23 V23_MIN and time	0~65535	word	R
1050H~1053H	Min of V31 V31_MIN and time	0~65535	word	R
1054H~1057H	Min of I1 I1_MIN and time	0~65535	word	R
1058H~105BH	Min of I2 I2_MIN and time	0~65535	word	R
105CH~105FH	Min of I3 I3_MIN and time	0~65535	word	R

The data format of statistics measurements is the same as that of Basis measurements. This address space is stored meter run time and load run-time parameters, as shown in the table.

Table 4-33 run time parameter address

180H	Meter run time (high 16 bit)	0~999999999	Dword	R
181H	Meter run time (low 16 bit)			
182H	Load run time (high 16 bit)	0~999999999	Dword	R
183H	Load run time (low 16 bit)			

The table below is the conversion relationship for run time.

Table 4-34 Conversion relationship of run time

Parameter	Relationship	Unit
Meter run time	$Run_Hur = Rx/10$	H
Load run time	$Run_LoadHur = Rx/10$	H

Parameter setting

Function code: 03 read; 16 preset

Address	Parameters	Type of access	Data Range	Data Type
0100H	Access code	R/W	0~9999	word
0101H	Communication address	R/W	1~247	word
0102H	Baud rate	R/W	1200~57600	word
0103H	Voltage wiring type	R/W	0: 3Ln; 1: 3LL; 2: 2LL; 3: 1Ln; 4: 1LL	word
0104H	Current wiring type	R/W	0: 3CT; 1: 2CT; 2: 1CT	word
0105H	PT1 (high 16 bit)	R/W	50.0~1000000.0	word
0106H	PT1 (low 16 bit)	R/W		word
0107H	PT2	R/W	50.0~400.0	word
0108H	CT1	R/W	1~50000	word
0109H	CT2	R/W	1, 5 or 333	word

010AH	Definition of ractive power	R/W	0: sinusoidal 1: nonsinusoidal	word
010BH	Back light time	R/W	0~120(min)	word
010CH	Time of demand slide window	R/W	1~30	word
010DH	Clear max	R/W	0AH:clear	word
010EH	Clear energy enable	R/W	0:disable;1:enable	word
010FH	Clear energy	R/W	0:disable; 0AH:enable	word
0110H	Clear run hour	R/W	0AH:clear, other: do not clear	word
0111H	Clear load run hour	R/W	0: EVEN; 1: odd; 2: NON2; 3:NON1	word
0112H	Parity check choice	R/W	0:IEC;1:IEEE	word
0113H	VAR/PF choice	R/W	0AH:clear,other:do not clear	word
0114H	H Sharp tariff demand clear	R/W	0AH:clear,other:do not clear	word
0115H	Peak tariff demand clear	R/W	0AH:clear,other:do not clear	word
0116H	Valley tariff demand clear	R/W	0AH:clear,other:do not clear	word
0117H	Normal tariff demand clear	R/W	0AH:clear,other:do not clear	word
0118H	Total tariff demand clear	R/W	0AH:clear,other:do not clear	word

Parameter of clock

Function code:03 read, 16: preset

Table 4-35 Data address of setting parameter

Address	Parameters	Range	Data Type	Type of access
0184H	Year	2000-2099	Word	R/W
0185H	Month	1-12	Word	R/W
0186H	Day	1-31	Word	R/W
0187H	Hour	0-23	Word	R/W
0188H	Minute	0-59	Word	R/W
0189H	Second	0-59	Word	R/W
018AH	Week	0-6	Word	R/W

Energy measurements

The data address of energy measurements includes real time energy and TOU energy, the relationship between the real time energy and TOU energy as the following table:

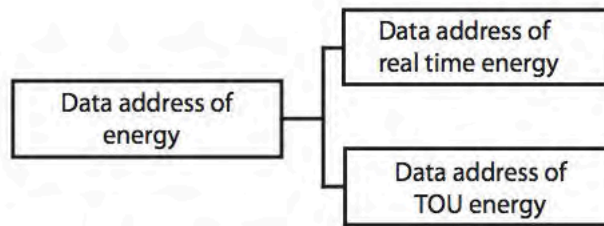

Fig. 4-37 division plans of energy address

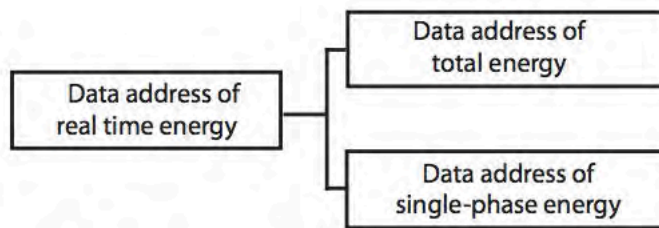

Fig. 4-38 division plans of real time energy

Data address of real time energy and single-phase energy, function: 03 read; 16 preset.

Table 4-37 data address of real time energy

Address	Parameters	Range	Data Type	Type of access
0156H~0157H	Import energy Ep_imp	0~999999999	Dword	R/W
0158H~0159H	Export energy Ep_exp	0~999999999	Dword	R/W
015AH~015BH	Import reactive energy Eq_imp	0~999999999	Dword	R/W
015CH~015DH	Export reactive energy Eq_exp	0~999999999	Dword	R/W
015EH~015FH	Apparent energy Es	0~999999999	Dword	R/W
0160H~0161H	Phase-A import energy Ep_imp	0~999999999	Dword	R/W
0162H~0163H	Phase-A export energy Ep_exp	0~999999999	Dword	R/W
0164H~0165H	Phase-B import energy Ep_imp	0~999999999	Dword	R/W
0166H~0167H	Phase-B export energy Ep_exp	0~999999999	Dword	R/W
0168H~0169H	Phase-C import energy Ep_imp	0~999999999	Dword	R/W
016AH~016BH	Phase-C export energy Ep_exp	0~999999999	Dword	R/W
016CH~016DH	Phase-A reactive import energy Eq_imp	0~999999999	Dword	R/W
016EH~016FH	Phase-A reactive export energy Eq_exp	0~999999999	Dword	R/W
0170H~0171H	Phase-B reactive import energy Eq_imp	0~999999999	Dword	R/W
0172H~0173H	Phase-B reactive export energy Eq_exp	0~999999999	Dword	R/W
0174H~0175H	Phase-C reactive import energy Eq_imp	0~999999999	Dword	R/W
0176H~0177H	Phase-C reactive export energy Eq_exp	0~999999999	Dword	R/W
0178H~0179H	Phase-A apparent energy Es_a	0~999999999	Dword	R/W
017AH~017BH	Phase-B apparent energy Es_b	0~999999999	Dword	R/W
017CH~017DH	Phase-C apparent energy Es_c	0~999999999	Dword	R/W

Table 4-38 Conversion of energy parameter

parameter	relationship	unit
Power energy Ep_imp,Ep_exp	$E_p = R_x/10$	kWh
Reactive energy Eq_imp,Eq_exp	$E_p = R_x/10$	Kvarh
Apparent energy Es	$E_p = R_x/10$	kVah

Data address of TOU energy

The data address save the parameter of energy, which includes Data address of last month TOU energy, Data address of current month TOU energy, Data address of TOU parameter setting and Data address of TOU default parameter. Except for the data address of TOU default parameter, the data address could be read with 03 code, preset with 16 code.

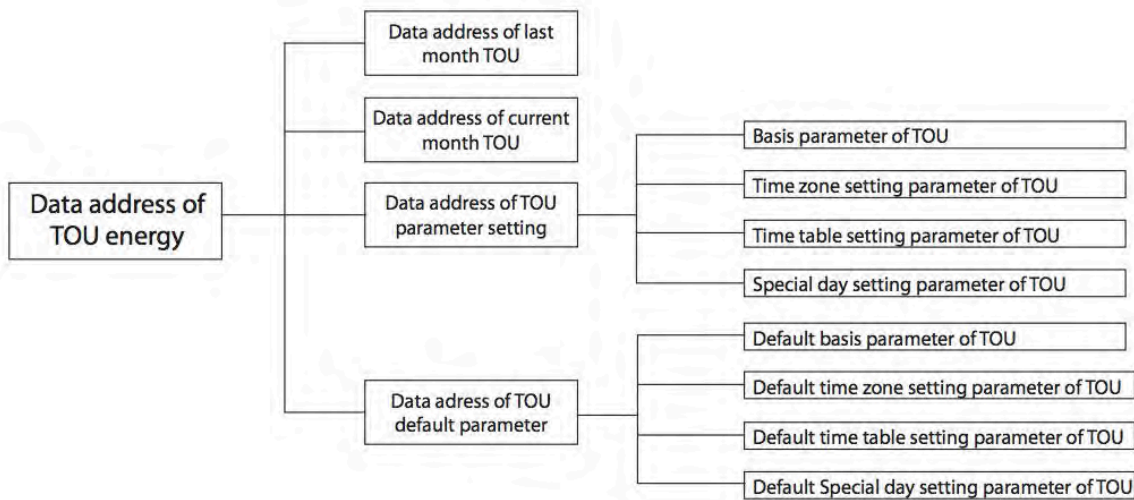

Fig. 4-39 division plan of TOU energy

Table 4-39 data address of last and current month

Current month TOU energy				
Address	Parameter	Range	Data Type	Types of access
200H~201H	Ep_imp(sharp) Ep_exp(sharp) Eq_im(sharp) Eq_exp(sharp) Es(sharp)	0~999999999	Dword	R/W
202H~203H		0~999999999	Dword	R/W
204H~205H		0~999999999	Dword	R/W
206H~207H		0~999999999	Dword	R/W
208H~209H		0~999999999	Dword	R/W
20AH~20BH	Ep_imp(peak) Ep_exp(peak) Eq_imp(peak) Eq_exp(peak) Es(peak)	0~999999999	Dword	R/W
20CH~20DH		0~999999999	Dword	R/W
20EH~20FH		0~999999999	Dword	R/W
210H~211H		0~999999999	Dword	R/W
212H~213H		0~999999999	Dword	R/W
214H~215H	Ep_imp(valley) Ep_exp(valley) Eq_imp(valley) Eq_exp(valley) Es(valley)	0~999999999	Dword	R/W
216H~217H		0~999999999	Dword	R/W
218H~219H		0~999999999	Dword	R/W
21AH~21BH		0~999999999	Dword	R/W
21CH~21DH		0~999999999	Dword	R/W
21EH~21FH	Ep_imp(normal) Ep_exp(normal) Eq_imp(normal) Eq_exp(normal) Es(normal)	0~999999999	Dword	R/W
220H~221H		0~999999999	Dword	R/W
222H~223H		0~999999999	Dword	R/W
224H~225H		0~999999999	Dword	R/W
226H~227H		0~999999999	Dword	R/W
228H~229H	Ep_imp(sum) Ep_exp(sum) Eq_imp(sum) Eq_exp(sum) Es(sum)	0~999999999	Dword	R/W
22AH~22BH		0~999999999	Dword	R/W
22CH~22DH		0~999999999	Dword	R/W
22EH~22FH		0~999999999	Dword	R/W
230H~231H		0~999999999	Dword	R/W

Last month TOU energy				
Address	Parameter	Range	Data Type	Types of access
232H~233H	Ep_imp(sharp) Ep_exp(sharp) Eq_imp(sharp) Eq_exp(sharp) Es(sharp)	0~999999999	Dword	R/W
234H~235H		0~999999999	Dword	R/W
236H~237H		0~999999999	Dword	R/W
238H~239H		0~999999999	Dword	R/W
23AH~23BH		0~999999999	Dword	R/W
23CH~23DH	Ep_imp(peak) Ep_exp(peak) Eq_imp(peak) Eq_exp(peak) Es(peak)	0~999999999	Dword	R/W
23EH~23FH		0~999999999	Dword	R/W
240H~241H		0~999999999	Dword	R/W
242H~243H		0~999999999	Dword	R/W
244H~245H		0~999999999	Dword	R/W
246H~247H	Ep_imp(valley) Ep_exp(valley) Eq_imp(valley) Eq_exp(valley) Es(valley)	0~999999999	Dword	R/W
248H~249H		0~999999999	Dword	R/W
24AH~24BH		0~999999999	Dword	R/W
24CH~24DH		0~999999999	Dword	R/W
24EH~24FH		0~999999999	Dword	R/W
250H~251H	Ep_imp(normal) Ep_exp(normal) Eq_imp(normal) Eq_exp(normal) Es(normal)	0~999999999	Dword	R/W
252H~253H		0~999999999	Dword	R/W
254H~255H		0~999999999	Dword	R/W
256H~257H		0~999999999	Dword	R/W
258H~259H		0~999999999	Dword	R/W
25AH~25BH	Ep_imp(sum) Ep_exp(sum) Eq_imp(sum) Eq_exp(sum) Es(sum)	0~999999999	Dword	R/W
25CH~25DH		0~999999999	Dword	R/W
25EH~25FH		0~999999999	Dword	R/W
260H~261H		0~999999999	Dword	R/W
262H~263H		0~999999999	Dword	R/W

Data address of TOU parameter setting includes basis parameter of TOU, time zone setting parameter of TOU, time table setting parameter of TOU and holiday setting parameter of TOU. Function: 03 code, 16: preset.

Table 4-40 data address of TOU

Basis parameter of TOU				
0800H	number of time zone	0~12	Word	R/W
0801H	number of time table	0~14	Word	R/W
0802H	number of time interval	0~14	Word	R/W
0803H	fee	0~3	Word	R/W
0804H	Weekly rest	0~127	Word	R/W
0805H	time table of Weekly rest	0~14	Word	R/W
0806H	number of special day	0~30	Word	R/W
0807H	Function enable of TOU	1:enable	Word	R/W
0808H	Initialization of TOU	1:enable	Word	R/W
0809H	Choice of calculation	0:end of month; 1: setting day	Word	R/W
080AH	The time of caculation: day	1~31	Word	R/W
080BH	The time of caculation: hour	0~23	Word	R/W
080CH	The time of caculation: minute	0~59	Word	R/W
080DH	The time of caculation: second	0~59	Word	R/W
080EH	TOU energy parameter Setting error status word	0: the setting of parameter is correct; 1: the fee in parameter setting is error; 2: the time interval num is error; 4: the time table num is error; 8: the time zone num is error;		

		16: the parameter setting in time zone is error; 32: the special day num is error; 64: the parameter setting in special day is error; 256: the fee in time table is error; 512: the time setting in time table is error; 1024: the time interval in time table is error; 2048: the time interval of week rest is error; 4096: the setting parameter of weekend is error;
Time zone setting parameter of TOU		
0820H~0822H	data and the time table Of the 1st time zone	Word R/W
0823H~0825H	data and the time tableOf the 2nd time zone	Word R/W
0826H~0828H	data and the time tableOf the 3rd time zone	Word R/W
0829H~082BH	data and the time tableOf the 4th time zone	Word R/W
082CH~082EH	data and the time tableOf the 5th time zone	Word R/W
082FH~0831H d	data and the time tableOf the 6th time zone	Word R/W
0832H~0834H d	data and the time tableOf the 7th time zone	Word R/W
0835H~0837H	data and the time tableOf the 8th time zone	Word R/W
0838H~083AH	data and the time tableOf the 9th time zone	Word R/W
083BH~083DH	data and the time tableOf the 10th time zone	Word R/W
083EH~0840H	data and the time tableOf the 11th time zone	Word R/W
0841H~0843H	data and the time tableOf the 12th time zone	Word R/W

Time table parameter of TOU				
0844H~0846H	1 st time interval and fee of the 1 st time table		Word	R/W
0847H~0849H	2 nd time interval and fee of the 1 st time table		Word	R/W
084AH~084CH	3 rd time interval and fee of the 1 st time table		Word	R/W
084DH~084FH	4 th time interval and fee of the 1 st time table		Word	R/W
0850H~0852H	5 th time interval and fee of the 1 st time table		Word	R/W
0853H~0855H	6 th time interval and fee of the 1 st time table		Word	R/W
0856H~0858H	7 th time interval and fee of the 1 st time table		Word	R/W
0859H~085BH	8 th time interval and fee of the 1 st time table		Word	R/W
085CH~085EH	9 th time interval and fee of the 1 st time table		Word	R/W
085FH~0861H	10 th time interval and fee of the 1 st time table		Word	R/W
0862H~0864H	11 th time interval and fee of the 1 st time table		Word	R/W
0865H~0867H	12 th time interval and fee of the 1 st time table		Word	R/W
0868H~086AH	13 th time interval and fee of the 1 st time table		Word	R/W
086BH~086DH	14 th time interval and fee of the 1 st time table		Word	R/W
086EH~0897H	From 1 st to 14 th time interval and fee of the 2 th time table	The same as 1 st time table	Word	R/W
0898H~08C1H	From 1 st to 14 th time interval and fee of the 3 th time table	The same as 1 st time table	Word	R/W
08C2H~08EBH	From 1 st to 14 th time interval and fee of the 4 th time table	The same as 1 st time table	Word	R/W
08ECH~0915H	From 1 st to 14 th time interval and fee of the 5 th time table	The same as 1 st time table	Word	R/W

0916H~093FH	From 1 st to 14 th time interval and fee of the 6 th time table	The same as 1 st time table	Word	R/W
0940H~0969H	From 1 st to 14 th time interval and fee of the 7 th time table	The same as 1 st time table	Word	R/W
096AH~0993H	From 1 st to 14 th time interval and fee of the 8 th time table	The same as 1 st time table	Word	R/W
0994H~09BDH	From 1 st to 14 th time interval and fee of the 9 th time table	The same as 1 st time table	Word	R/W
09BEH~09E7H	From 1 st to 14 th time interval and fee of the 10 th time table	The same as 1 st time table	Word	R/W
09E8H~0A11H	From 1 st to 14 th time interval and fee of the 11 th time table	The same as 1 st time table	Word	R/W
0A12H~0A3BH	From 1 st to 14 th time interval and fee of the 12 th time table	The same as 1 st time table	Word	R/W
0A3CH~0A65H	From 1 st to 14 th time interval and fee of the 13 th time table	The same as 1 st time table	Word	R/W
0A66H~0A8FH	From 1 st to 14 th time interval and fee of the 14 th time table	The same as 1 st time table	Word	R/W
Special day parameter of TOU				
0A90H~0A92H	data and the time tableOf the 1 st holiday		Word	R/W
0A93H~0A95H	data and the time tableOf the 2 nd holiday		Word	R/W
0A96H~0A98H	data and the time table Of the 3 rd holiday		Word	R/W
0A99H~0A9BH	data and the time table Of the 4 th holiday		Word	R/W
0A9CH~0A9EH	data and the time table Of the 5 th holiday		Word	R/W
0A9FH~0AA1H	data and the time table Of the 6 th holiday		Word	R/W
0AA2H~0AA4H	data and the time table Of the 7 th holiday		Word	R/W

0AA5H~0AA7H	data and the time table Of the 8 th holiday		Word	R/W
0AA8H~0AAAH	data and the time table Of the 9 th holiday		Word	R/W
0AABH~0AADH	data and the time table Of the 10 th holiday		Word	R/W
0AAEH~0AB0H	data and the time table Of the 11 th holiday		Word	R/W
0AB1H~0AB3H	data and the time table Of the 12 th holiday		Word	R/W
0AB4H~0AB6H	data and the time table Of the 13 th holiday		Word	R/W
0AB7H~0AB9H	data and the time table Of the 14 th holiday		Word	R/W
0ABAH~0ABCH	data and the time table Of the 15 th holiday		Word	R/W
0ABDH~0ABFH	data and the time table Of the 16 th holiday		Word	R/W
0AC0H~0AC2H	data and the time table Of the 17 th holiday		Word	R/W
0AC3H~0AC5H	data and the time table Of the 18 th holiday		Word	R/W
0AC6H~0AC8H	data and the time table Of the 19 th holiday		Word	R/W
0AC9H~0ACBH	data and the time table Of the 20 th holiday		Word	R/W
0ACCH~0ACEH	data and the time table Of the 21 th holiday		Word	R/W
0ACFH~0AD1H	data and the time table Of the 22 th holiday		Word	R/W
0AD2H~0AD4H	data and the time table Of the 23 th holiday		Word	R/W
0AD5H~0AD7H	data and the time table Of the 24 th holiday		Word	R/W
0AD8H~0ADAH	data and the time table Of the 25 th holiday		Word	R/W
0ADBH~0ADDH	data and the time table Of the 26 th holiday		Word	R/W
0ADEH~0AE0H	data and the time table Of the 27 th holiday		Word	R/W
0AE1H~0AE3H	data and the time table Of the 28 th holiday		Word	R/W

0AE4H~0AE6H	data and the time table Of the 29 th holiday		Word	R/W
0AE7H~0AE9H	data and the time table Of the 30 th holiday		Word	R/W
0AEAH	Holiday setting enable		Word	R/W
0AEBH	Start year holiday setting		Word	R/W
0AECH	End year holiday setting		Word	R/W

The address area includes ten years holiday setting, Function: 03H Read 10H Preset

Table 4-41 Data address of ten years holiday

The 1 st year Holiday address Function: 03H Read 10H Preset				
B00H~B02H	The 1 st holiday and time table (format: month /day /time table)	word		R/W
B03H~B05H	The 2 nd holiday and time table	word		R/W
B06H~B08H	The 3 rd holiday and time table	word		R/W
B09H~B0BH	The 4 th holiday and time table	word		R/W
B0CH~B0EH	The 5 th holiday and time table	word		R/W
B0FH~B11H	The 6 th holiday and time table	word		R/W
B12H~B14H	The 7 th holiday and time table	word		R/W
B15H~B17H	The 8 th holiday and time table	word		R/W
B18H~B1AH	The 9 th holiday and time table	word		R/W
B1BH~B1DH	The 10 th holiday and time table	word		R/W
B1EH~B20H	The 11 th holiday and time table	word		R/W
B21H~B23H	The 12 th holiday and time table	word		R/W
B24H~B26H	The 13 th holiday and time table	word		R/W
B27H~B29H	The 14 th holiday and time table	word		R/W
B2AH~B2CH	The 15 th holiday and time table	word		R/W
B2DH~B2FH	The 16 th holiday and time table	word		R/W
B30H~B32H	The 17 th holiday and time table	word		R/W
B33H~B35H	The 18 th holiday and time table	word		R/W
B36H~B38H	The 19 th holiday and time table	word		R/W
B39H~B3BH	The 20 th holiday and time table	word		R/W
B3CH~B3EH	The 21 th holiday and time table	word		R/W
B3FH~B41H	The 22 th holiday and time table	word		R/W
B42H~B44H	The 23 th holiday and time table	word		R/W
B45H~B47H	The 24 th holiday and time table	word		R/W
B48H~B4AH	The 25 th holiday and time table	word		R/W
B4BH~B4DH	The 26 th holiday and time table	word		R/W
B4EH~B50H	The 27 th holiday and time table	word		R/W
B51H~B53H	The 28 th holiday and time table	word		R/W

B54H~B56H	The 29 th holiday and time table	word		R/W
B57H~B59H	The 30 th holiday and time table	word		R/W
B5AH	The 1 st setting year	word		R/W
B5BH	Holiday number of the 1 st year	word		R/W
The 2 nd year Holiday address Function: 03H Read 10H Preset				
B5CH~B5EH	The 1 st holiday and time table (format: month /day /time table)	word		R/W
B5FH~B61H	The 2 nd holiday and time table	word		R/W
B62H~B64H	The 3 rd holiday and time table	word		R/W
B65H~B67H	The 4 th holiday and time table	word		R/W
B68H~B6AH	The 5 th holiday and time table	word		R/W
B6BH~B6DH	The 6 th holiday and time table	word		R/W
B6EH~B70H	The 7 th holiday and time table	word		R/W
B71H~B73H	The 8 th holiday and time table	word		R/W
B74H~B76H	The 9 th holiday and time table	word		R/W
B77H~B79H	The 10 th holiday and time table	word		R/W
B7AH~B7CH	The 11 th holiday and time table	word		R/W
B7DH~B7FH	The 12 th holiday and time table	word		R/W
B80H~B82H	The 13 th holiday and time table	word		R/W
B83H~B85H	The 14 th holiday and time table	word		R/W
B86H~B88H	The 15 th holiday and time table	word		R/W
B89H~B8BH	The 16 th holiday and time table	word		R/W
B8CH~B8EH	The 17 th holiday and time table	word		R/W
B8FH~B91H	The 18 th holiday and time table	word		R/W
B92H~B94H	The 19 th holiday and time table	word		R/W
B95H~B97H	The 20 th holiday and time table	word		R/W
B98H~B9AH	The 21 th holiday and time table	word		R/W
B9BH~B9DH	The 22 th holiday and time table	word		R/W
B9EH~BA0H	The 23 th holiday and time table	word		R/W
BA1H~BA3H	The 24 th holiday and time table	word		R/W
BA4H~BA6H	The 25 th holiday and time table	word		R/W
BA7H~BA9H	The 26 th holiday and time table	word		R/W
BAAH~BACH	The 27 th holiday and time table	word		R/W
BADH~BAFH	The 28 th holiday and time table	word		R/W
BB0H~BB2H	The 29 th holiday and time table	word		R/W
BB3H~BB5H	The 30 th holiday and time table	word		R/W
BB6H	The 2 nd setting year	word		R/W
BB7H	Holiday number of the 2 nd year	word		R/W
The 3 rd year Holiday address Function: 03H Read 10H Preset				
BB8H~BBAH	The 1 st holiday and time table (format: month /day /time table)	word		R/W
BBBH~BBDH	The 2 nd holiday and time table	word		R/W

BBEH~BC0H	The 3 rd holiday and time table	word		R/W
BC1H~BC3H	The 4 th holiday and time table	word		R/W
BC4H~BC6H	The 5 th holiday and time table	word		R/W
BC7H~BC9H	The 6 th holiday and time table	word		R/W
BCAH~BCCH	The 7 th holiday and time table	word		R/W
BCDH~BCFH	The 8 th holiday and time table	word		R/W
BD0H~BD2H	The 9 th holiday and time table	word		R/W
BD3H~BD5H	The 10 th holiday and time table	word		R/W
BD6H~BD8H	The 11 th holiday and time table	word		R/W
BD9H~BDBH	The 12 th holiday and time table	word		R/W
BDCH~BDEH	The 13 th holiday and time table	word		R/W
BDFH~BE1H	The 14 th holiday and time table	word		R/W
BE2H~BE4H	The 15 th holiday and time table	word		R/W
BE5H~BE7H	The 16 th holiday and time table	word		R/W
BE8H~BEAH	The 17 th holiday and time table	word		R/W
BEBH~BEDH	The 18 th holiday and time table	word		R/W
BEEH~BF0H	The 19 th holiday and time table	word		R/W
BF1H~BF3H	The 20 th holiday and time table	word		R/W
BF4H~BF6H	The 21 th holiday and time table	word		R/W
BF7H~BF9H	The 22 th holiday and time table	word		R/W
BFAH~BFCH	The 23 th holiday and time table	word		R/W
BFDH~BFFH	The 24 th holiday and time table	word		R/W
C00H~C02H	The 25 th holiday and time table	word		R/W
C03H~C05H	The 26 th holiday and time table	word		R/W
C06H~C08H	The 27 th holiday and time table	word		R/W
C09H~C0BH	The 28 th holiday and time table	word		R/W
C0CH~C0EH	The 29 th holiday and time table	word		R/W
C0FH~C11H	The 30 th holiday and time table	word		R/W
C12H	The 3 rd setting year	word		R/W
C13H	Holiday number of the 3 rd year	word		R/W
The 4th year Holiday address Function: 03H Read 10H Preset				
C14H~C16H	The 1 st holiday and time table (format: month /day /time table)	word		R/W
C17H~C19H	The 2 nd holiday and time table	word		R/W
C1AH~C1CH	The 3 rd holiday and time table	word		R/W
C1DH~C1FH	The 4 th holiday and time table	word		R/W
C20H~C22H	The 5 th holiday and time table	word		R/W
C23H~C25H	The 6 th holiday and time table	word		R/W
C26H~C28H	The 7 th holiday and time table	word		R/W
C29H~C2BH	The 8 th holiday and time table	word		R/W
C2CH~C2EH	The 9 th holiday and time table	word		R/W
C2FH~C31H	The 10 th holiday and time table	word		R/W

C32H~C34H	The 11 th holiday and time table	word		R/W
C35H~C37H	The 12 th holiday and time table	word		R/W
C38H~C3AH	The 13 th holiday and time table	word		R/W
C3BH~C3DH	The 14 th holiday and time table	word		R/W
C3EH~C40H	The 15 th holiday and time table	word		R/W
C41H~C43H	The 16 th holiday and time table	word		R/W
C44H~C46H	The 17 th holiday and time table	word		R/W
C47H~C49H	The 18 th holiday and time table	word		R/W
C4AH~C4CH	The 19 th holiday and time table	word		R/W
C4DH~C4FH	The 20 th holiday and time table	word		R/W
C50H~C52H	The 21 th holiday and time table	word		R/W
C53H~C55H	The 22 th holiday and time table	word		R/W
C56H~C58H	The 23 th holiday and time table	word		R/W
C59H~C5BH	The 24 th holiday and time table	word		R/W
C5CH~C5EH	The 25 th holiday and time table	word		R/W
C5FH~C61H	The 26 th holiday and time table	word		R/W
C62H~C64H	The 27 th holiday and time table	word		R/W
C65H~C67H	The 28 th holiday and time table	word		R/W
C68H~C6AH	The 29 th holiday and time table	word		R/W
C6BH~C6DH	The 30 th holiday and time table	word		R/W
C6EH	The 4 th setting year	word		R/W
C6FH	Holiday number of the 4 th year	word		R/W
The 5 th year Holiday address Function: 03H Read 10H Preset				
C70H~C72H	The 1 st holiday and time table (format: month /day /time table)	word		R/W
C73H~C75H	The 2 nd holiday and time table	word		R/W
C76H~C78H	The 3 rd holiday and time table	word		R/W
C79H~C7BH	The 4 th holiday and time table	word		R/W
C7CH~C7EH	The 5 th holiday and time table	word		R/W
C7FH~C81H	The 6 th holiday and time table	word		R/W
C82H~C84H	The 7 th holiday and time table	word		R/W
C85H~C87H	The 8 th holiday and time table	word		R/W
C88H~C8AH	The 9 th holiday and time table	word		R/W
C8BH~C8DH	The 10 th holiday and time table	word		R/W
C8EH~C90H	The 11 th holiday and time table	word		R/W
C91H~C93H	The 12 th holiday and time table	word		R/W
C94H~C96H	The 13 th holiday and time table	word		R/W
C97H~C99H	The 14 th holiday and time table	word		R/W
C9AH~C9CH	The 15 th holiday and time table	word		R/W
C9DH~C9FH	The 16 th holiday and time table	word		R/W
CA0H~CA2H	The 17 th holiday and time table	word		R/W
CA3H~CA5H	The 18 th holiday and time table	word		R/W

CA6H~CA8H	The 19 th holiday and time table	word		R/W
CA9H~CABH	The 20 th holiday and time table	word		R/W
CACH~CAEH	The 21 th holiday and time table	word		R/W
CAFH~CB1H	The 22 th holiday and time table	word		R/W
CB2H~CB4H	The 23 th holiday and time table	word		R/W
CB5H~CB7H	The 24 th holiday and time table	word		R/W
CB8H~CBAH	The 25 th holiday and time table	word		R/W
CBBH~CBDH	The 26 th holiday and time table	word		R/W
CBEH~CC0H	The 27 th holiday and time table	word		R/W
CC1H~CC3H	The 28 th holiday and time table	word		R/W
CC4H~CC6H	The 29 th holiday and time table	word		R/W
CC7H~CC9H	The 30 th holiday and time table	word		R/W
CCA H	The 5 th setting year	word		R/W
CCBH	Holiday number of the 5 th year	word		R/W
The 6 th year Holiday address Function: 03H Read 10H Preset				
CCCH~CCEH	The 1 st holiday and time table (format: month /day /time table)	word		R/W
CCFH~CD1H	The 2 nd holiday and time table	word		R/W
CD2H~CD4H	The 3 rd holiday and time table	word		R/W
CD5H~CD7H	The 4 th holiday and time table	word		R/W
CD8H~CDAH	The 5 th holiday and time table	word		R/W
CDBH~CDDH	The 6 th holiday and time table	word		R/W
CDEH~CE0H	The 7 th holiday and time table	word		R/W
CE1H~CE3H	The 8 th holiday and time table	word		R/W
CD4H~CE6H	The 9 th holiday and time table	word		R/W
CE7H~CE9H	The 10 th holiday and time table	word		R/W
CEAH~CECH	The 11 th holiday and time table	word		R/W
CEDH~CEFH	The 12 th holiday and time table	word		R/W
CF0H~CF2H	The 13 th holiday and time table	word		R/W
CF3H~CF5H	The 14 th holiday and time table	word		R/W
CF6H~CF8H	The 15 th holiday and time table	word		R/W
CF9H~CFBH	The 16 th holiday and time table	word		R/W
CFCH~CFEH	The 17 th holiday and time table	word		R/W
CFFH~D01H	The 18 th holiday and time table	word		R/W
D02H~D04H	The 19 th holiday and time table	word		R/W
D05H~D07H	The 20 th holiday and time table	word		R/W
D08H~D0AH	The 21 th holiday and time table	word		R/W
D0BH~D0DH	The 22 th holiday and time table	word		R/W
D0EH~D10H	The 23 th holiday and time table	word		R/W
D11H~D13H	The 24 th holiday and time table	word		R/W
D14H~D16H	The 25 th holiday and time table	word		R/W
D17H~D19H	The 26 th holiday and time table	word		R/W

D1AH~D1CH	The 27 th holiday and time table	word		R/W
D1DH~D1FH	The 28 th holiday and time table	word		R/W
D20H~D22H	The 29 th holiday and time table	word		R/W
D23H~D25H	The 30 th holiday and time table	word		R/W
D26H	The 6 th setting year	word		R/W
D27H	Holiday number of the 6 th year	word		R/W
The 7 th year Holiday address Function: 03H Read 10H Preset				
D28H~D2AH	The 1 st holiday and time table (format: month /day /time table)	word		R/W
D2BH~D2DH	The 2 nd holiday and time table	word		R/W
D2EH~D30H	The 3 rd holiday and time table	word		R/W
D31H~D33H	The 4 th holiday and time table	word		R/W
D34H~D36H	The 5 th holiday and time table	word		R/W
D37H~D39H	The 6 th holiday and time table	word		R/W
D3AH~D3CH	The 7 th holiday and time table	word		R/W
D3DH~D3FH	The 8 th holiday and time table	word		R/W
D40H~D42H	The 9 th holiday and time table	word		R/W
D43H~D45H	The 10 th holiday and time table	word		R/W
D46H~D48H	The 11 th holiday and time table	word		R/W
D49H~D4BH	The 12 th holiday and time table	word		R/W
D4CH~D4EH	The 13 th holiday and time table	word		R/W
D4FH~D51H	The 14 th holiday and time table	word		R/W
D52H~D54H	The 15 th holiday and time table	word		R/W
D55H~D57H	The 16 th holiday and time table	word		R/W
D58H~D5AH	The 17 th holiday and time table	word		R/W
D5BH~D5DH	The 18 th holiday and time table	word		R/W
D5EH~D60H	The 19 th holiday and time table	word		R/W
D61H~D63H	The 20 th holiday and time table	word		R/W
D64H~D66H	The 21 th holiday and time table	word		R/W
D67H~D69H	The 22 th holiday and time table	word		R/W
D6AH~D6CH	The 23 th holiday and time table	word		R/W
D6DH~D6FH	The 24 th holiday and time table	word		R/W
D70H~D72H	The 25 th holiday and time table	word		R/W
D73H~D75H	The 26 th holiday and time table	word		R/W
D76H~D78H	The 27 th holiday and time table	word		R/W
D79H~D7BH	The 28 th holiday and time table	word		R/W
D7CH~D7EH	The 29 th holiday and time table	word		R/W
D7FH~D81H	The 30 th holiday and time table	word		R/W
D82H	The 7 th setting year	word		R/W
D83H	Holiday number of the 7 th year	word		R/W
The 8 th year Holiday address Function: 03H Read 10H Preset				

D84H~D86H	The 1 st holiday and time table (format: month /day /time table)	word		R/W
D87H~D89H	The 2 nd holiday and time table	word		R/W
D8AH~D8CH	The 3 rd holiday and time table	word		R/W
D8DH~D8FH	The 4 th holiday and time table	word		R/W
D90H~D92H	The 5 th holiday and time table	word		R/W
D93H~D95H	The 6 th holiday and time table	word		R/W
D96H~D98H	The 7 th holiday and time table	word		R/W
D99H~D9BH	The 8 th holiday and time table	word		R/W
D9CH~D9EH	The 9 th holiday and time table	word		R/W
D9FH~DA1H	The 10 th holiday and time table	word		R/W
DA2H~DA4H	The 11 th holiday and time table	word		R/W
DA5H~DA7H	The 12 th holiday and time table	word		R/W
DA8H~DAAH	The 13 th holiday and time table	word		R/W
DABH~DADH	The 14 th holiday and time table	word		R/W
DAEH~DB0H	The 15 th holiday and time table	word		R/W
DB1H~DB3H	The 16 th holiday and time table	word		R/W
DB4H~DB6H	The 17 th holiday and time table	word		R/W
DB7H~DB9H	The 18 th holiday and time table	word		R/W
DBAH~DBCH	The 19 th holiday and time table	word		R/W
DBDH~DBFH	The 20 th holiday and time table	word		R/W
DC0H~DC2H	The 21 th holiday and time table	word		R/W
DC3H~DC5H	The 22 th holiday and time table	word		R/W
DC6H~DC8H	The 23 th holiday and time table	word		R/W
DC9H~DCBH	The 24 th holiday and time table	word		R/W
DCCH~DCEH	The 25 th holiday and time table	word		R/W
DCFH~DD1H	The 26 th holiday and time table	word		R/W
DD2H~DD4H	The 27 th holiday and time table	word		R/W
DD5H~DD7H	The 28 th holiday and time table	word		R/W
DD8H~DDAH	The 29 th holiday and time table	word		R/W
DDBH~DDDH	The 30 th holiday and time table	word		R/W
DDEH	The 8 th setting year	word		R/W
DDFH	Holiday number of the 8 th year	word		R/W
The 9th year Holiday address Function: 03H Read 10H Preset				
DE0H~DE2H	The 1 st holiday and time table (format: month /day /time table)	word		R/W
DE3H~DE5H	The 2 nd holiday and time table	word		R/W
DE6H~DE8H	The 3 rd holiday and time table	word		R/W
DE9H~DEBH	The 4 th holiday and time table	word		R/W
DECH~DEEH	The 5 th holiday and time table	word		R/W
DEFH~DF1H	The 6 th holiday and time table	word		R/W
DF2H~DF4H	The 7 th holiday and time table	word		R/W

DF5H~DF7H	The 8 th holiday and time table	word		R/W
DF8H~DFAH	The 9 th holiday and time table	word		R/W
DFBH~DFDH	The 10 th holiday and time table	word		R/W
DFEH~E00H	The 11 th holiday and time table	word		R/W
E01H~E03H	The 12 th holiday and time table	word		R/W
E04H~E06H	The 13 th holiday and time table	word		R/W
E07H~E09H	The 14 th holiday and time table	word		R/W
E0AH~E0CH	The 15 th holiday and time table	word		R/W
E0DH~E0FH	The 16 th holiday and time table	word		R/W
E10H~E12H	The 17 th holiday and time table	word		R/W
E13H~E15H	The 18 th holiday and time table	word		R/W
E16H~E18H	The 19 th holiday and time table	word		R/W
E19H~E1BH	The 20 th holiday and time table	word		R/W
E1CH~E1EH	The 21 th holiday and time table	word		R/W
E1FH~E21H	The 22 th holiday and time table	word		R/W
E22H~E24H	The 23 th holiday and time table	word		R/W
E25H~E27H	The 24 th holiday and time table	word		R/W
E28H~E2AH	The 25 th holiday and time table	word		R/W
E2BH~E2DH	The 26 th holiday and time table	word		R/W
E2EH~E30H	The 27 th holiday and time table	word		R/W
E31H~E33H	The 28 th holiday and time table	word		R/W
E34H~E36H	The 29 th holiday and time table	word		R/W
E37H~E39H	The 30 th holiday and time table	word		R/W
E3AH	The 9 th setting year	word		R/W
E3BH	Holiday number of the 9 th year	word		R/W
The 10 th year Holiday address Function: 03H Read 10H Preset				
E3CH~E3EH	The 1 st holiday and time table (format: month /day /time table)			
E3FH~E41H	The 2 nd holiday and time table			
E42H~E44H	The 3 rd holiday and time table			
E45H~E47H	The 4 th holiday and time table			
E48H~E4AH	The 5 th holiday and time table			
E4BH~E4DH	The 6 th holiday and time table			
E4EH~E50H	The 7 th holiday and time table			
E51H~E53H	The 8 th holiday and time table			
E54H~E56H	The 9 th holiday and time table			
E57H~E59H	The 10 th holiday and time table			
E5AH~E5CH	The 11 th holiday and time table			
E5DH~E5FH	The 12 th holiday and time table			
E60H~E62H	The 13 th holiday and time table			
E63H~E65H	The 14 th holiday and time table			
E66H~E68H	The 15 th holiday and time table			

E69H~E6BH	The 16 th holiday and time table			
E6CH~E6EH	The 17 th holiday and time table			
E6FH~E71H	The 18 th holiday and time table			
E72H~E74H	The 19 th holiday and time table			
E75H~E77H	The 20 th holiday and time table			
E78H~E7AH	The 21 th holiday and time table			
E7BH~E7DH	The 22 th holiday and time table			
E7EH~E80H	The 23 th holiday and time table			
E81H~E83H	The 24 th holiday and time table			
E84H~E86H	The 25 th holiday and time table			
E87H~E89H	The 26 th holiday and time table			
E8AH~E8CH	The 27 th holiday and time table			
E8DH~E8FH	The 28 th holiday and time table			
E90H~E92H	The 29 th holiday and time table			
E93H~E95H	The 30 th holiday and time table			
E96H	The 10 th setting year			
E97H	Holiday number of the 10 th year			

Extend IO Setting Area

It includes extend IO communication parameter, DO related parameter and DI related parameter. in the extended IO communication section includes ways to set the baud rate and parity; DO parameters section includes: pulse output and alarm output function options, when set to pulse output functions, including pulse constant, pulse width and high level of output delay settings; When set to alarm output functions, including alarm delay, alarm conditions and alarm limits setting. The DI setting contains the DI function selection and pulse constant setting, the bit0- bit3 correspond to the DI1 to DI4 state in the 0x3D0 address. If the value of bit0 is 1, it indicates the DI1 status is pulse counting state. If the value of bit0 is 0, it indicates the DI1 status is SOE state. Another bit's function is same as bit0.

Note: For Acuvim-L, it's no DI options, address 3C0h ~ 3 CCH is valid, the other is invalid.

Table 4-42 Extend IO Parameter setting

DO Parameter Setting : 03H Read ;10H Write				
Address	Parameter	Range	Type	Type of access
3C0H	Do1 function choice	0:pulse output 1:alarm output	word	R/W
3C1H	Do2 function choice	0:pulse output 1:alarm output	word	R/W
3C2H	Pulse constant	800~60000	word	R/W
3C3H	High level delay	1~50(20ms)	word	R/W

3C4H	Do1 output energy choice	0:none: 1:Import energy Ep_imp 2:Export energy Ep_exp 3:Import reactive energy Eq_imp 4:Export reactive energy Eq_exp	word	R/W
3C5H	Do2 output energy choice	0:none; 1:Import energy Ep_imp 2:Export energy Ep_exp 3:Import reactive energy Eq_imp 4:Export reactive energy Eq_exp	word	R/W
3C6H	Alarm delay	0~255(300ms)	word	R/W
3C7H	Do1 alarm choice	0~34	word	R/W
3C8H	Do1 alarm condition	0 <; 1 >;	word	R/W
3C9H	Do1 alarm limit	-32767~32768	word	R/W
3CAH	Do2 alarm choice	0~34	word	R/W
3CBH	Do2 alarm condition	0 <; 1 >;	word	R/W
3CCH	Do2 alarm limit	-32767~32768	word	R/W
3CDH	Extend communication Baud rate	1200-57600	word	R/W
3CEH	H Extend communication Parity check	0: EVEN 1: odd 2:NON2 3:NON1	word	R/W
3CFH	Alarm back light blink setting	0:enable: 1:disable	word	R/W
DI parameter setting: 03H Read;10H Write				
3D0H	Bit0/ Bit1/ Bit2/ Bit3: 0 SOE state ; Bit0/ Bit1/ Bit2/ Bit3: 1 pulse counter state;		; 0 - 15	R/W
3D1H	High Byte of pulse accumulation constant		1-65535	R/W
3D2H	DI counter clear		0x0A: clear Other: NONE	R/W

The address area contains pulse counter number. The pulse counter number could be reserved with power-down, it also could be clear through PC software.

DI counter parameter:03H Read;10H Write			
0x3A0H~0x3A1H	DI1 counter number	0-4294967295	Dword
0x3A2H~0x3A3H	DI2 counter number	0-4294967295	Dword
0x3A4H~0x3A5H	DI3 counter number	0-4294967295	Dword
0x3A6H~0x3A7H	DI4 counter number	0-4294967295	Dword

It contains 20 SOE events during 0x300 and 0x363 address area, it indicates 1st SOE event address area from 0x300H to 0x304, the format as: year-month, day-hour, minute-second, millisecond and DI state. The other's format is same as first event.

Table 4-44 SOE event parameter address area

SOE event record area: 03H Read			
0x300H	Year of 1st SOE Event (High Byte)	00-99	word
	Month of 1st SOE Event (Low Byte)	1-12	
0x301H	Day of 1st SOE Event (High Byte)	1-31	word
	Hour of 1st SOE Event (Low Byte)	0-23	
0x302H	Minute of 1st SOE Event (High Byte)	0-59	word
	Second of 1st SOE Event (Low Byte)	0-59	
0x303H	Millisecond of 1st SOE Event	0-999	word
0x304H	1 st SOE event state	0-15	word
0x305H~0x309H	2 nd SOE event	same	word
0x30aH~0x30eH	3 rd SOE event	same	word
0x30fH~0x313H	4 th SOE event	same	word
0x314H~0x318H	5 th SOE event	same	word
0x319H~0x31dH	6 th SOE event	same	word
0x31eH~0x322H	7 th SOE event	same	word
0x323H~0x327H	8 th SOE event	same	word
0x328H~0x32cH	9 th SOE event	same	word
0x32dH~0x331H	10 th SOE event	same	word
0x332H~0x336H	11 th SOE event	same	word
0x337H~0x33bH	12 th SOE event	same	word
0x33cH~0x340H	13 th SOE event	same	word
0x341H~0x345H	14 th SOE event	same	word
0x346H~0x34aH	15 th SOE event	same	word
0x34bH~0x34fH	16 th SOE event	same	word

0x350H~0x354H	17 th SOE event	same	word
0x355H~0x359H	18 th SOE event	same	word
0x35aH~0x35eH	19 th SOE event	same	word
0x35fH~0x363H	20 th SOE event	same	word

The address area for the SOE single event reading, through continuous reading of the address area of a single SOE record, achieving the current single SOE records continuously updated to meet the SOE event to read all 20 goals. One address 0x406H, the type of access is read and write, it can achieve the specified single event reading by writing the location of a single SOE records to the address.

SOE single event record area: 03H Read; 10H Write				
0x380H	Year of 1st SOE Event (High Byte)	00-99	word	R
	Month of 1st SOE Event (Low Byte)	1-12		
0x381H	Day of 1st SOE Event (High Byte)	1-31	word	R
	Hour of 1st SOE Event (Low Byte)	0-23		
0x382H	Minute of 1st SOE Event (High Byte)	0-59	word	R
	second of 1st SOE Event (Low Byte)	0-59		
0x383H	Millisecond of 1st SOE Event	0-999	word	R
0x384H	SOE event state	0-15	word	R
0x385H	The latest record group number of single SOE event	0:none	word	R
		1-20: the The latest record group number		
0x386H	Current group number of single SOE event	Other:none	word	R
		1-20: Current group number	word	R

Digital Output State

The user can monitor DO state by reading the address area. The function code is 01H.

Table 4-46 DO State Reading Area

DI State Reading Area: 02 Function			
Address	Parameter	Range	Type
0000H	DO1	1:ON 0:OFF	bit
0001H	DO2	1:ON 0:OFF	bit

Digital Input State

The user can monitor DI state by reading the address area. The function code is 02H.

Table 4-47 DI State Reading Area

DI State Reading Area: 02 Function			
Address	Parameter	Range	Type
0000H	DI1	1:ON 0:OFF	bit
0001H	DI2	1:ON 0:OFF	bit
0002H	DI3	1:ON 0:OFF	bit
0003H	DI4	1:ON 0:OFF	bit

Note:

1. data type:

Word: unsigned integer of 16 bit;

Integer: signed integer of 16 bit;

DWord: unsigned integer of 32 bit;

Float: float data of 32 bit.

2. type of access

R: read only, data read by using function code 03.

R/W: read and write, data read by using function 03 and written by using function code 16.

It is forbidden to write data address which does not possess property to be written.

3. Energy and run time

Energy and run time data are represented in 32 bits. Both high 16 bit and low 16 bit have successive address alone. The high 16 bit should be multiplied by 65535 and plus low 16-bit data to get the energy and run time data in master software. The unit is 0.1kWh, 0.1kVarh and 0.1hour. The energy register can be cleared or preset via communication. The register of run time can be cleared and cannot be preset.

Acuvim-L Series Power Meter

Appendix

Appendix A Technical Data and Specifications

Appendix B Ordering Information

Appendix C Revision History



Appendix

Appendix A Technical Data and Specification

Input ratings

Voltage Input	
Voltage rating	400 LN / 690 LL Vac RMS (3-phase) 400 LN Vac RMS (single-phase) With 20% overage Installation Category III, Pollution Degree 2
Frequency range	45~65Hz
Overload	2 times (continuously); 2500Vac per second (no recurrence)
PT burden	<0.2VA
Measuring	True-RMS

Current input	
Current rating	5Amp AC (1Amp AC Optional)
Current range	50000A highest at primary side
Overload	10A (continuously); 100A per sec (no recurrence)
CT burden	<0.5VA
Measuring	True-RMS

Accuracy

Parameters	METERING		Range
	Accuracy	Resolution	
Voltage	0.5%	0.1V	10V~1000kV
Current	0.5%	0.001A	0~50000A
Current Demand	0.5%	0.001A	0~50000A
Power	0.5%	1W	-9999~9999MW
Reactive Power	0.5%	1var	-9999~9999Mvar
Apparent Power	0.5%	1VA	0~9999MVA
Power Demand	0.5%	1W	-9999~9999MW
Reactive Power Demand	0.5%	1var	-9999~9999MVar
Apparent Power Demand	0.5%	1VA	0~9999MVA
Power Factor	0.5%	0.001	-1.0~1.0
Frequency	0.5%	0.01Hz	45.00~65.00Hz
Energy	0.5%	0.1kWh	0~99999999.9kWh
Reactive Energy	0.5%	0.1kvarh	0~99999999.9kvarh
Apparent Energy	0.5%	0.1VAh	0~99999999.9kVah
Harmonics	1%	0.01%	
Running		0.1hrs	0~99999999.9hrs
Running Time		0.1hrs	0~99999999.9hrs

Standards	
Measuring	IEC 62053-22; ANSI C12.20
Environmental	IEC 60068-2
Safety	IEC 61010-1, UL 61010-1
EMC	IEC 61000-4/-2-3-4-5-6-8-11
Dimension	DIN 43700, ANSI C39.1

Digital input (DI)	
Input Type	Dry Contact
Input Resistance	4k Ω
Pulse Frequency (Max)	100Hz, 50% Duty Ratio
SOE Resolution	2ms

Digital output (DO) (Photo-MOS)	
Voltage Range	0~250Vac/dc
Load Current	100mA (Max)
Output Frequency (Max)	25Hz, 50% Duty Ratio
Isolation Voltage	2500V

Suitable condition	
Dimensions (mm)	96×96×51 (cutting-out 92×92 or 4inch Round)
Protection level	IP56 (front), IP30 (cover)
Weight	350g
Operating temp. range	-25°C ~ 70°C
Storage temp. range	-40°C ~ 85°C
Humidity	5%~95%, non-condensation
Power supply	100~415Vac, 50/60Hz; 100~300Vdc
Power consumption	3W

Communication port
<p>The first way RS-485 (Option) Modbus®-RTU Protocol 2-wire connection, Half-duplex, Isolated 1200 to 57600 baud rate Second way RS485 communication (Acuvim-DL, and Acuvim-EL optional) (Work the same way as the first road RS485)</p>
<p>PROFI-BUS (Option) (Acuvim-DL and Acuvim-EL Option) PROFIBUS-DP/V0 Protocol PROFIBUS slave mode, baud rate adaptive, up to 12M Typical input bytes: 32; typical output bytes: 32 Comply with EN 50170 vol.2</p>
<p>Ethernet (Option) Support Modbus-TCP/IP protocol communication, web access, regular mail send and other functions (Acuvim-DL, and Acuvim-EL optional)</p>

Appendix B Ordering Information

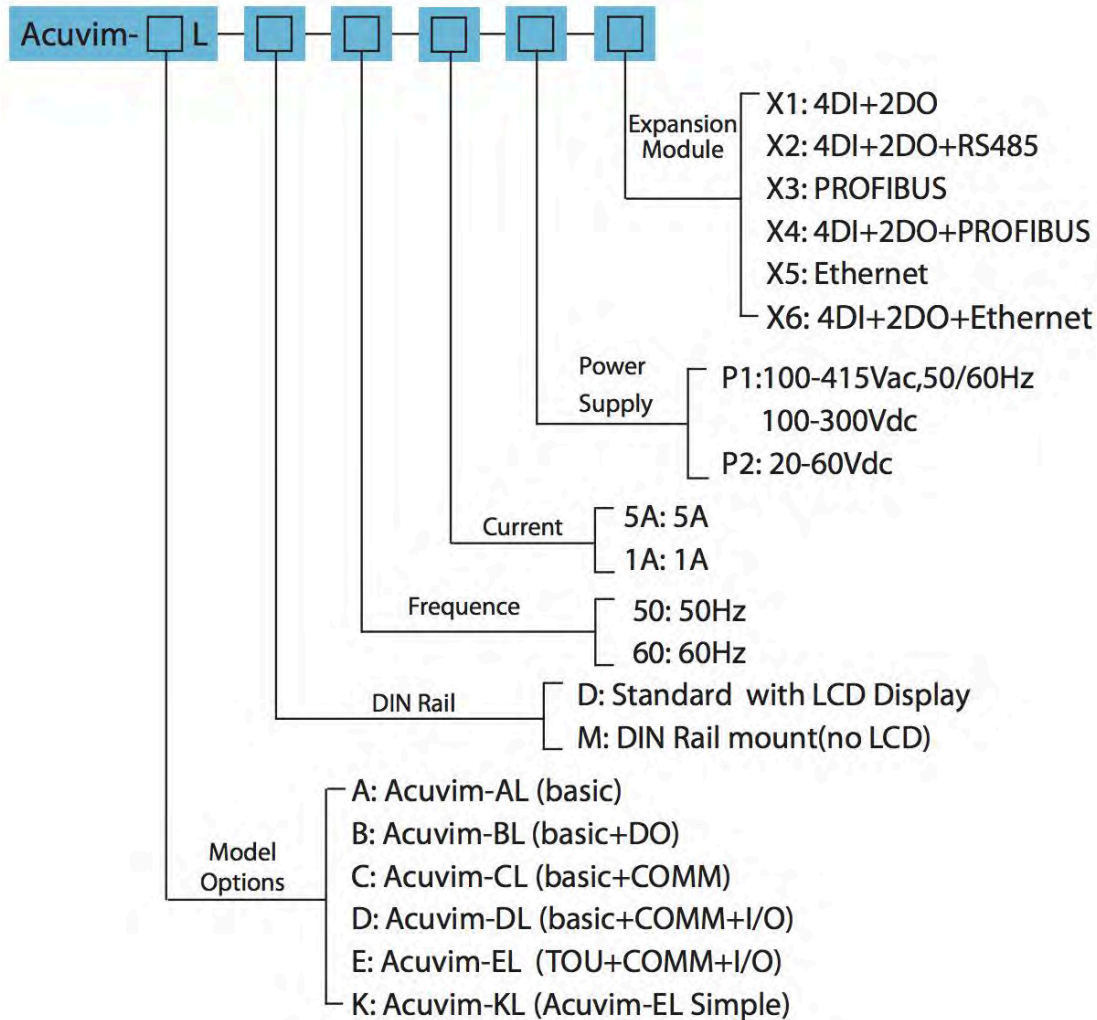

Note:

1. Extent Module only support by Acuvim-DL and Acuvim-EL.
2. The Extend Module X4 and X6 consist of IO module and Profibus module. The Profibus and Ethernet module must be installed on the back of the meter first before the other module are attached.

Remote Display Option



DS1: Compatible with Acuvim-L Series "M" (DIN Mount) models only

Appendix C Revision History

Revisions	Date	Description
1.0	20070915	First version
1.1	20070930	Add primary data address table of Basic measurements data and Statistics measurements data.
1.2	20071109	Add Apparent energy function. See Page 37 and Page 69.
1.3	20090430	Add single phase apparent power, apparent power demand and the max of apparent power demand; Update the ordering information.
1.31	20090515	Add TOU function
1.40	20091023	
1.41	20100401	Add TOU energy Display, TOU maximum demand and Holiday auto-switch.
1.42	20101031	Revise the content
1.43	20110430	Updated appendix part of data
1.44	20110530	DI type modified from wet contact to dry connect; add contents of PROFIBUS module.
1.45	20120725	Update the method for generating CRC value Add a "Note" in page 52.
2.01	20130510	<ol style="list-style-type: none"> 1. Add Ethernet module. 2. Harmonic measurement range was changed from 2 to 31 times. 3. Update the list of features for each model. 4. Update Ordering; 5. Updated wiring 6. Update the calculation method of the three-phase unbalance of Acuvim-EL. 7. Update the definition of the degree pulse constant. 8. Update the buttons and contents of display part.