

AcuRev 2000

Smart Metering System

User's Manual



ACCUENERGY

The information contained in this document is believed to be accurate at the time of publication, however, Accuenergy assumes no responsibility for any errors which may appear here and reserves the right to make changes without notice. Please ask the local representative for latest product specifications before ordering.

Please read this manual carefully before installation, operation and maintenance of AcuRev 2000 series meter. The following symbols in this manual are used to provide warning of danger or risk during the installation and operation of the meters.



Electric Shock Symbol: Carries information about procedures which must be followed to reduce the risk of electric shock and danger to personal health.



Safety Alert Symbol: Carries information about circumstances which if not considered may result in injury or death.

Prior to maintenance and repair, the equipment must be de-energized and grounded. All maintenance work must be performed by qualified, competent accredited professionals who have received formal training and have experience with high voltage and current devices. Accuenergy shall not be responsible or liable for any damages or injuries caused by improper meter installation and/or operation.

Contents

Chapter 1 Introduction -----	1
1.1 Meter Overview-----	2
1.2 Area of Application-----	4
1.3 AcuRev 2000 Series Features-----	4
Chapter 2 Installation -----	7
2.1 Appearance and Dimensions-----	9
2.2 Installation Methods-----	14
2.3 Wiring-----	20
Chapter 3 Meter Display and Operation -----	33
3.1 Display Panel and Keys-----	34
3.2 Energy Display and Operation-----	37
3.3 Demand Display and Operation-----	40
3.4 I/O Display and Operation-----	42
3.5 Parameter Settings-----	44
3.6 Shortcut Keys-----	46
3.7 Real-Time Parameters-----	67
3.8 Device Information-----	70
3.9 Network Settings-----	73
3.10 Meter information and key operation-----	74
Chapter 4 Functions and Software -----	75
4.1 Basic Parameter Functions-----	79

4.2 I/O Functions-----	81
4.3 Demand-----	84
4.4 Energy-----	86
4.5 Sequence of Event-----	92
4.6 Over/Under Limit Alarming-----	93
4.7 System Event-----	96
4.8 Trending Record-----	97
4.9 Seal Function-----	101
4.10 Device Information-----	112
Chapter 5 Communication-----	113
5.1 Modbus Protocol Introduction-----	114
5.2 Modbus Communication Format-----	117
5.3 Ethernet communication-----	123
5.4 Application Details and Parameter Address Table-----	159
Appendix-----	245
Appendix A Technical Data and Specifications-----	246
Appendix B Pulse Output Setup-----	249
Appendix C Ordering Information-----	251
Appendix D DTP900 meter reader Instructions-----	257
Appendix E Revision History-----	261

Welcome to AcuRev 2000!

You have purchased an advanced, versatile, multifunction power meter.

Please note the following chapter descriptions in order to utilize the power meter properly.

Chapter 1 Introduces the basic AcuRev 2000 features and application areas.

Chapter 2 Introduces AcuRev 2000 installation and wiring methods in detail.

Chapter 3 Walks through how to operate AcuRev 2000 via the display panel, display measurement data and parameter settings.

Chapter 4 Introduces AcuRev 2000 functions with the included software.

Chapter 5 Introduces communication related information, including protocol format and parameter address table.

Appendix The appendix provides AcuRev 2000 technical specifications and ordering information.

Chapter 1 Introduction

1.1 Meter Overview

1.2 Areas of Application

1.3 AcuRev 2000 features

1.1 Meter Overview

AccuRev 2000 series performs real-time metering, measures energy consumption and monitors power quality for up to 18 single phase circuits(or 6 three phase circuits)in one unit. It is an advanced intelligent power meter that Accuenergy developed and manufactured for the next generation smart grids. The main features include multi-tenants submetering, cyclic display, tamper proof, which make it highly suitable for large commercial facilities, residential apartments and industrial environments. AccuRev 2000 series has infrared, RS485 and Ethernet communication options as well as I/O options (e.g. Pulse Counting from water or gas meters), making it useful in energy management systems. Due to its communication capability, ease of installation and use, this product can be easily integrated into new and existing energy management systems.

Measurement Function

Voltage: Line Voltage; Phase Voltage

Current: In-line Current; Each Tenant Current

Power and Power Factor: In-line and Each Tenant Power, Reactive Power, Apparent Power, Power Factor

Frequency: System Frequency

Demand: In-line and Each Tenant Power, Reactive Power, Apparent Power and Current Demand.

Energy Function

Energy (kWh) measurement meeting international standards.

Accuracy is Class 0.5.

It has Time of Use feature: 14 Seasons, 14 Schedules, 4 Tariffs, supporting weekend and holiday settings, supporting daylight saving time and 10-year holidays automatic

switching; It supports kWh pulse output.

System Event Logging

This product runs self-check on systems. When an important operation is performed (such as reset, energy or demand clear, system parameter changes), it immediately records the event timestamp, event type (via event state word), and judges whether relay output needs to be sent.

Over/Under Limit Alarming

Users can select parameters and set their setpoints. An alarm will be triggered when the setpoint is reached. At the same time, sound and light signals could be sent out via relay output. The time and reason of an alarm event will be recorded.

Power Quality Analysis

Power quality parameters such as voltage and current THD, Odd harmonic distortion (Total Odd HD), even harmonic distortion (Total Even HD), 2 ~ 31 times the harmonic content, Current K-factor (KF), crest factor (CF), telephone interference factor (THFF), voltage and current unbalance etc. will be monitored.

I/O Option

Standard output ports provide energy (kWh) pulse output and time pulse output; digital inputs (DI) provide pulse counting from water, electricity and gas meter, and monitor switch status; relay outputs (RO) react upon alarming conditions.

Data Logging and Load Trending

With 8MB of onboard memory, AcuRev 2000 series can log real-time metering parameters, I/O status, and energy measurement. This information can be used for historical trending and system analysis.

Communication and Network

Supports RS485 communication open protocol: Modbus RTU; supports 10/100M Ethernet interface with protocol ModBus-TCP, HTTP, SMTP, SNMP, DLMS/COSEM; meter reading via infrared port.

1.2 Areas of Application

Industrial environment

WARNING: This product shall be installed in an full enclosed industrial cabinet, the access to which is strictly limited to professional personnel.

1.3 AcuRev 2000 series Features

Multifunction, Multi-Tenants

AcuRev 2000 multi-tenants intelligent power meter utilizes powerful data acquisition and processing functions, which implements real-time metering and monitoring for up to 18 single phase circuits (or 6 three phase circuits) in one unit. It will also record system events, over/under limit alarming and data logging functions.

Innovative Display and Installation

Multi-tenant energy information is cycled through on the high resolution display. The display panel has two options: embedded in the unit or externally installed on a panel. Current input has two options: direct input 20(80A)or external CT model.

Flexible Wiring

Users can choose measuring circuits and wiring methods. Measuring circuit can be selected as 9 or 18 single phases, three phase 3x3 or 3x6, Single-phase or three-phase hybrid access , including single phase out(1LN), three phase 4 out (3LN), single phase 3 out(2LN), where “out” means the load side, Inline defaults to 3-phase 4-line(3LN).

Model Selection

AcuRev 2000 series has two models: AcuRev 2010(Basic Measurement) and AcuRev 2020(Multifunction). The function comparison is listed below:

● Standard; ○ Optional; Blank means Not Available

Function		Parameter	AcuRev 2010	AcuRev 2020
Energy	Real Energy	Ep	●	●
	Reactive Energy	Eq		●
	Apparent Energy	Es		●
TOU	4 Tariffs, 14 Schedules	TOU	●	●
	Daylight Saving Time	DST	●	●
	Holidays		●	●
Demand	Power Demand	Demad_P	●	●
	Power Demand Max	Demad_P_max	●	●
	Reactive power Demand	Demad_Q		●
	Reactive power Demand Max	Demad_Q_max		●
	Apparent Power Demand	Demad_S		●
	Apparent Power Demand Max	Demad_S_max		●
	Current Demand	Line & Each Tenant		●
	Current Demand Max	Line & Each Tenant		●
Real-time Parameter	Voltage	V1, V2, V3; V12, V23, V31		●
	Current	Line & Each Tenant		●
	Power	Line & Each Tenant	●	●
	Reactive Power	Line & Each Tenant		●
	Apparent Power	Line & Each Tenant		●
	Power Factor	Line & Each Tenant		●
	Nature of the load	Line & Each Tenant		
	Frequency	F		●

Power Quality	THD	THD		•
	Individual Harmonic	2nd-31st		•
	Current K Factor	KF		•
	Crest Factor	CF		•
	Voltage Unbalance	U_unbl		•
	Current Unbalance	I_unbl		•
	Voltage telephone interference factor	THFF		•
Clock	Year Month Day Hour Minute Second		•	•
Alarming	Over/Under Limit Alarm		•	•
Data Logging	Up to 8M		•	•
Communication	Infrared		•	•
	RS485	Modbus-RTU	•	•
		DL/T645	⊙	⊙
Ethernet	Modbus-TCP, HTTP, SMTP, SNMP, SNTP	⊙	⊙	
I/O	4DI	Demand Cycle, Second Pulse, 2-channel kWh Pulse Output	•	•
	8DI	Digital Output/Pulse Output	⊙	⊙
	4RO	channel Digital/ Alarming Output	⊙	⊙
Display	LCD Display		•	•

Table 1-1 Model Selection

Chapter 2 Installation

2.1 Appearance and Dimensions

2.2 Installation Methods

2.3 Wiring

Before Installation

❑ The installation must be performed by qualified, competent accredited professionals who have received formal training and have experience with high voltage and current devices. Appropriate safety wear (gloves, glasses, arc flash suit, etc.) is mandatory to ensure safe installation.

❑ During normal meter operation, caution should be used when handling the following as high voltage may be present: Terminal Blocks, Current Transformer connection nodes, Potential Transformer connection nodes and the related circuits. All primary and secondary circuits may contain lethal current and voltage. Contact with current channels must be avoided.

❑ The power meter and I/O modules cannot be installed on the primary side of transformers or where VA has limitations. The power meter can be only installed on the secondary side. Avoid contact with meter terminals after the completion of installation.

❑ Do not input voltage above the rated maximum limit of the power meter and devices connected to it. Before energizing the meter, please refer to the meter's label and specifications.

❑ Do not perform high voltage test / insulation experiment to output, input or communication terminals.

❑ The use of shorting blocks and fuses are recommended. Current transformers need to be grounded.

❑ Use dry cloth to wipe the meter.

❑ The replace of the Battery must be performed by professionals.

Note: Failure to follow manufacturer guidelines for installation and use may compromise the safety of the meter and the user.

Note: Any repair should only be performed by the manufacturer.

A switch or circuit breaker should be utilized in the equipment. The switch should be placed close to the equipment and easy to reach. The switch is regarded as a part of the breaking device.

2.1 Appearance and Dimensions

Category	Appearance
Meter Base	LxWxH 140x105.4x77.7mm
External CT Module(EM)	LxWxH 67x105.4x77.7mm
Internal CT Module(DM)	LxWxH 153x105.4x77.7mm
Display Module	LxWxH 72x72x26.5mm

Table 2-1 AcuRev 2000 Appearance

Meter Base

If a Display Module is specified, an RJ45 jack is equipped in the Meter Base, where the attached cable should be plugged in to connect the Display Module to the Meter Base. See Figure 2-1.

If the Display Module is not specified, the Display Module is embedded in the Meter Base. See Figure 2-2.

Appearance:



Figure 2-1 Meter Base with external Display Module



Figure 2-2 Meter Base with embedded Display Module

Dimensions

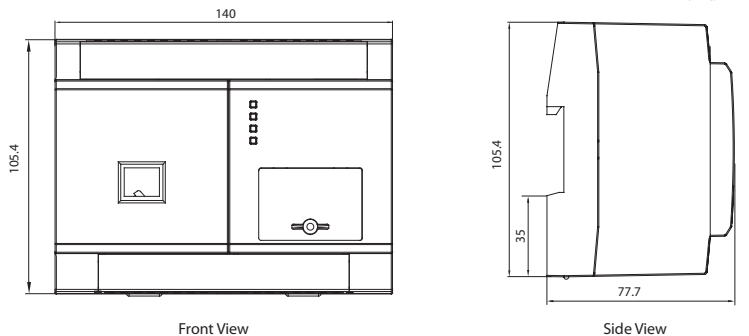

Figure 2-3 Meter Base dimensions

Display Module

The Display Module can also be panel mounted.

Appearance



Figure 2-4 Display Module

Dimensions

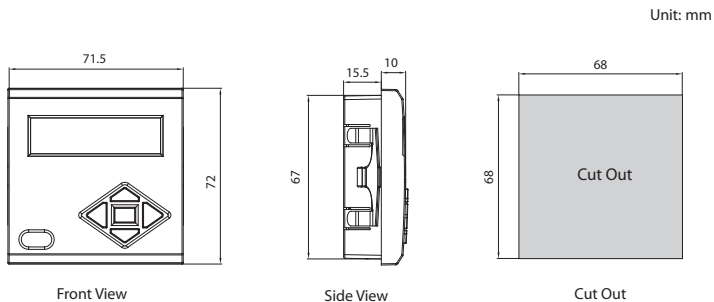

Figure 2-5 Display Module dimensions

External CT Module(EM)

Appearance



Figure 2-6 EM module appearance

Dimensions

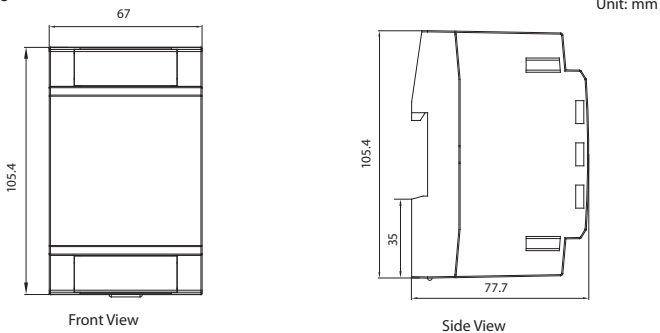

Figure 2-7 EM module dimensions

Internal CT Module (DM: Direct Module)

Appearance



Figure 2-8 DM module appearance

Dimensions

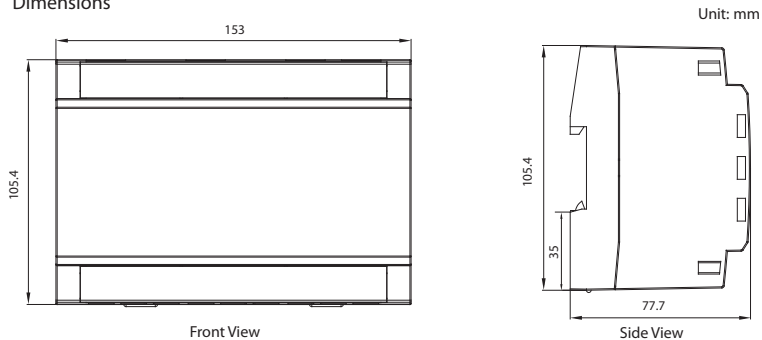

Figure 2-9 DM module dimensions

2.2 Installatin Methods

Environmental

Before installation, please check the environment, temperature and humidity to ensure the AcuRev 2000 series meter is being placed where it will not be damaged.

1. Temperature

AcuRev 2000 operating temperture is $-25\sim 70^{\circ}\text{C}$. Exceeding this temperature range will cause damage to the meter. Please note it can influence the meter life negatively if the meter operates in extremely high or extremely low temperatures. AcuRev 2000 storage temperature range is $-40\sim 85^{\circ}\text{C}$.

2. Humidity

5% to 95% non-condensing.

3. Location

AcuRev 2000 series meter should be installed in a dry and dust free environment. Avoid exposing meter to excessive heat, radiation and high electrical noise sources.

Installation of Meter Base and Modules

Below are examples of the assembled meter and modules.

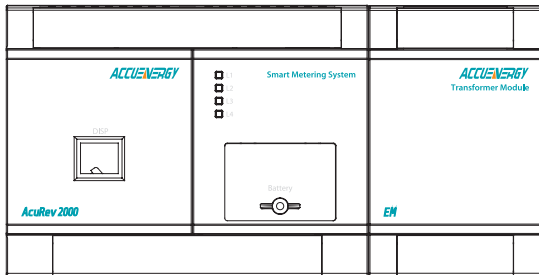

Figure 2-10 Meter Base connected with an EM module (9 channels)

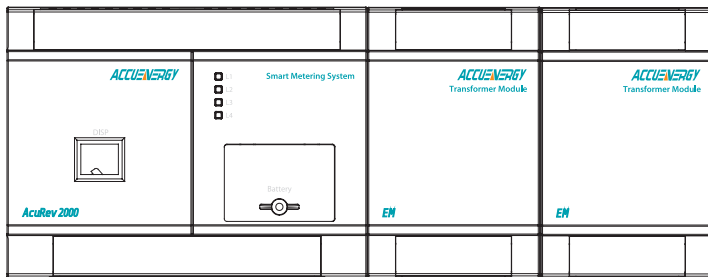

Figure 2-11 Meter Base connected with two EM modules (18 channels)

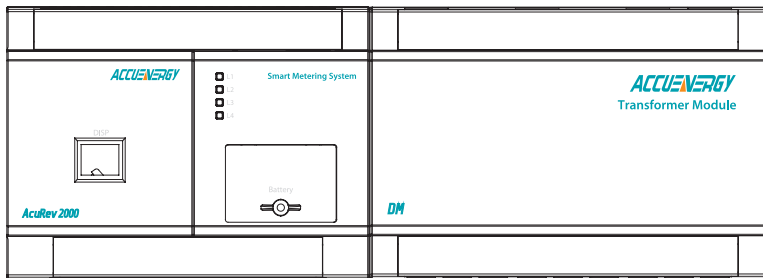

Figure 2-12 Meter Base connected with a DM module (9 channels)



Figure 2-13 Meter Base connected with two DM modules (18 channels)

Installation Steps:

This meter is DIN rail mounted, which fits 35 mm standard rails.

1. Insert the meter groove all the way into the rail, and flip the meter case as Figure below shows, making the meter mounted into the rail.

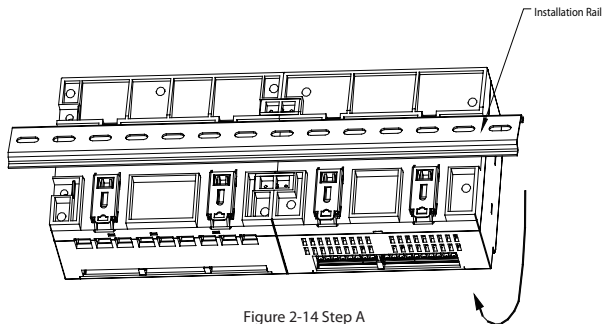

Figure 2-14 Step A

2. Use the metal clips to tighten the rail and installation will be completed.

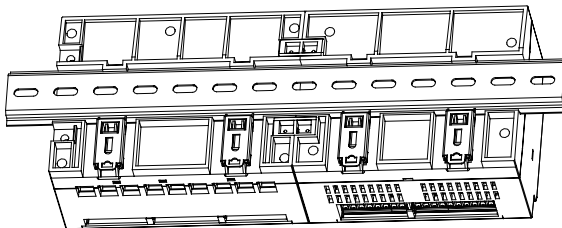

Figure 2-15 Step B

Display Module Installtion

The Display Module is factory installed on the meter base. Users can use the meter base and display module combination directly. The following steps show how Display Module is installed.

1) Firstly, make a standard panel Cut Out as the Figure 2-16 shows. Unit: mm.

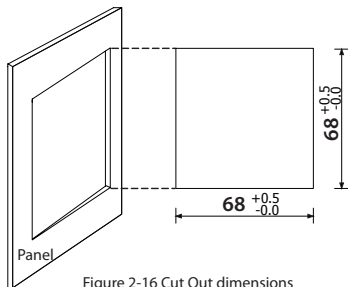

Figure 2-16 Cut Out dimensions

2) Remove the clips of Display Module, install the module into the Cut Out in the direction of arrow.

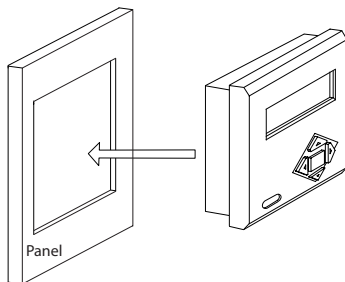

Figure 2-17 Insert Display Module into the Cut Out

3) Install the Display Module into the Cut Out. The module front panel will appear at the front of the Cut Out, the Meter Base case and wiring terminals will appear at the back of the Cut Out. Then, put on two installation clips following the grooves at the back of Display Module, and push forward to tighten the clips. Make sure the clip and the panel are joined tightly. Tighten the screws as Figure below shows and the installation is completed. See Figure 2-18.

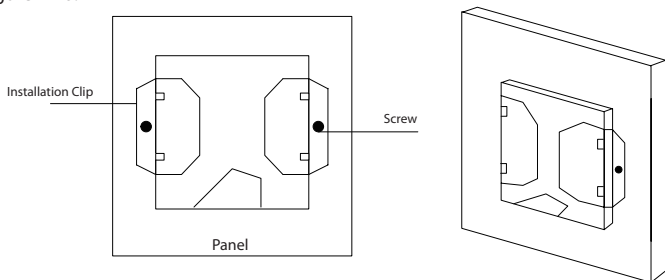

Figure 2-18 Use clips to affix the Display Module

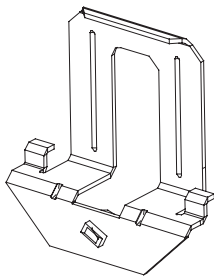

Figure 2-19 Installation Clip

2.3 Wiring

Terminals

Meter Base Terminals

Upper row: Power Supply, Pulse Output, Communication, NET

Lower row: Digital Input, Relay Output.

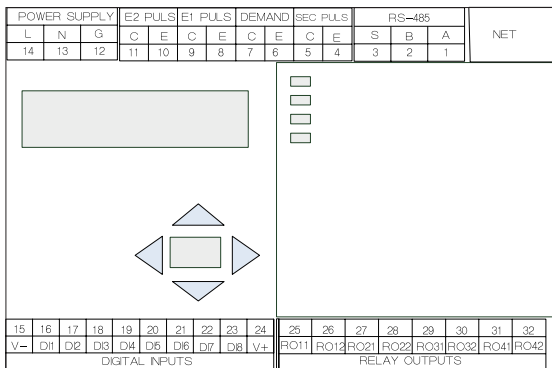

Figure 2-20 Meter Base Terminals

External CT Module(EM)Terminals

The upper row has voltage input terminals, the lower row has current input terminals. 9 channel inputs correspond to I1-I9, it only requires one EM1 module. 18 inputs correspond to I1-I18, it requires two modules: EM1 and EM2. The following figure shows 18 channel inputs.

EM1								EM2													
VOLTAGE INPUTS																					
VN		V3		V2		V1															
33		34		35		36															
-		38	40	42	44	46	48	50	52	54	-		56	58	60	62	64	66	68	70	72
11		12	13	14	15	16	17	18	19	110		111	112	113	114	115	116	117	118		
*		37	39	41	43	45	47	49	51	53	*		55	57	59	61	63	65	67	69	71
EM1 CURRENT INPUTS								EM2 CURRENT INPUTS													

Figure 2-21 External CT Module terminals

Internal CT Module(DM)Terminals

The upper level has voltage input terminals, the lower level has voltage output terminals.

9 channel inputs corresponds to V1-V3, it only requires one DM1 module.18 channel inputs corresponds to V1-V6, it requires two modules: EM1 and EM2.

DM1									DM2																	
V1 INPUT			V2 INPUT			V3 INPUT			VN			V4 INPUT			V5 INPUT			V6 INPUT			VN					
73			74			75			76			86			87			88			89					
77			78			79			80			81			82			83			84			85		
V11			V12			V13			V21			V22			V23			V31			V32			V33		
VOLTAGE OUTPUTS									VOLTAGE OUTPUTS																	
90			91			92			93			94			95			96			97			98		
V41			V42			V43			V51			V52			V53			V61			V62			V63		
VOLTAGE OUTPUTS									VOLTAGE OUTPUTS																	

Figure 2-22 DM module terminals

Aux. Power Supply

AcuRev 2000 power supply is 100-415Vac, 50/60Hz or 100-300Vdc, which are universally supported. If any other power supply is required, please contact the manufacturer. The power consumption of the power meter is low during normal operation, therefore, the power supply can be either via a standalone power supply or via the measured circuit. A regulator is recommended where the voltage is not stabilized. The power supply terminal number is L/N/G.

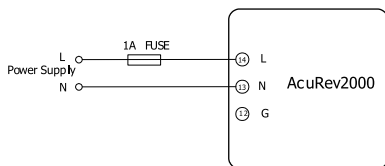

Figure 2-23 Power Supply wiring

Power Supply wiring is AWG22~16 or 0.6~1.5mm².

A fuse or small size circuit breaker is mandatory for AcuRev 2000 Power Supply. The fuse recommendation is 1A/250Vac, time delay. If a circuit breaker is utilized, it must be CE certified and comply with IEC 947 standard.

An isolated transformer or EMC filter should be used in the auxiliary power supply loop if there is a power quality problem in the power supply.

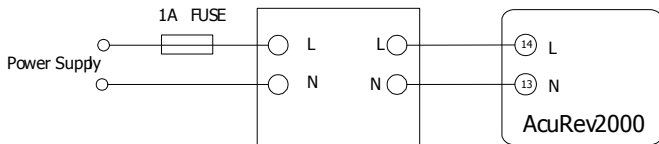

Figure 2-24 Power Supply wiring

Voltage Input signal

400Vac L-N , 690Vac L-L.A fuse (typical 1A/250Vac) or air circuit breaker must be used in the voltage input loop.

Current Input signal

Current Input has two options: Direct Connection or Via CT (Current Transformer) Connection. DM module is utilized in Direct Connection, while EM module is utilized in Via CT Connection.

For Direct Connection, each tenant maximum current is 80A, nominal current 20A.

For Via CT Connection, the CTs are solid core type, and should be installed first. The CT accuracy is 0.2%, options are 20A, 80A, 150A, 200A, 250A, 1000A Current transformer or 0.333V Voltage Transformer.

Vn Connection

Vn is the voltage reference point of AcuRev 2000, a low resistance to Vn connection contributes to a better measurement accuracy. Vn connection is related to the system wiring. Please refer to "Wiring Methods" for details.

Wiring Methods

AcuRev 2000 wiring methods can be selected in system parameter settings. Inline defaults to 3-phase 4-line(3LN), load wiring can be set to single-phase (1LN), three-phase four-wire (3LN), single-phase three-wire (2LN).

The followings introduces EM and DM wiring methods in those three scenarios.

1. Single phase out(1LN)

EM:

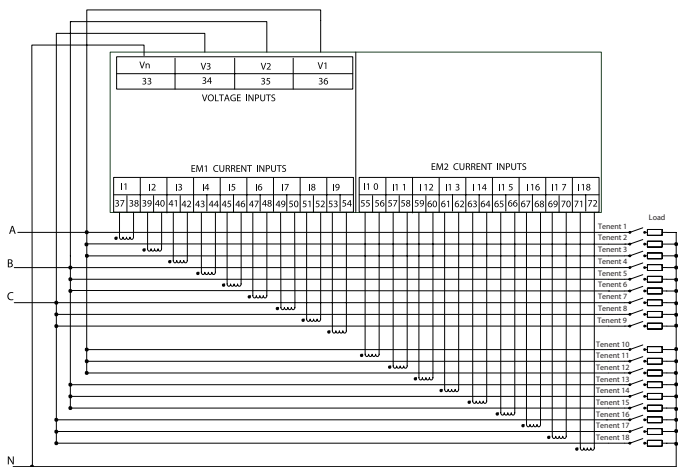
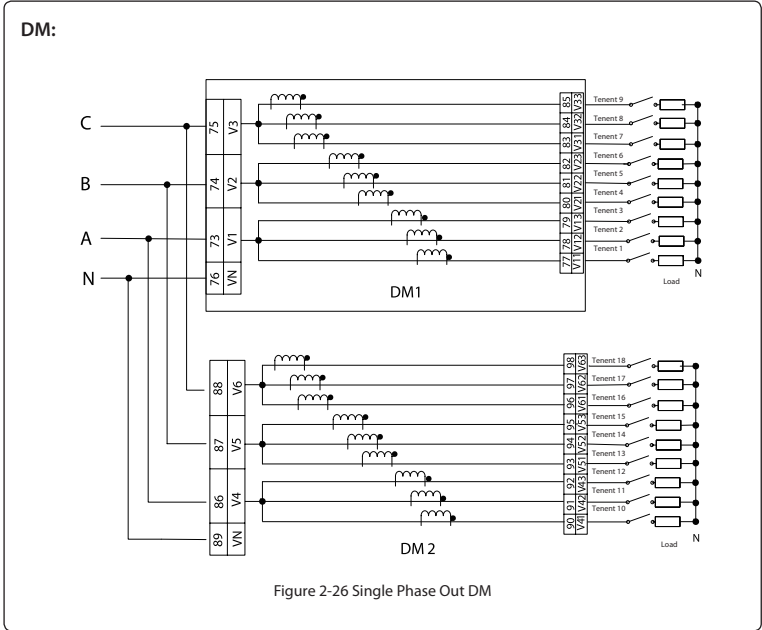

Figure 2-25 Single Phase Out EM



2. Three phase 4 out(3LN)

Table 2-2 Three Phase 4 Out current

	Tenant 1	Tenant 2	Tenant 3	Tenant 4	Tenant 5	Tenant 6
Phase A	I1	I2	I3	I10	I11	I12
Phase B	I4	I5	I6	I13	I14	I15
Phase C	I7	I8	I9	I16	I17	I18

EM:

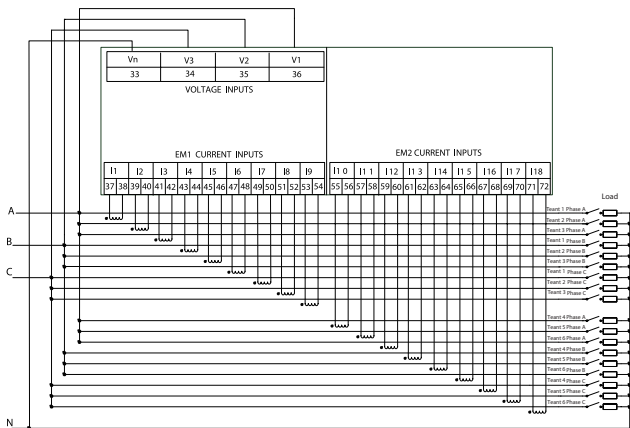

Figure 2-27 Three Phase 4 Out EM

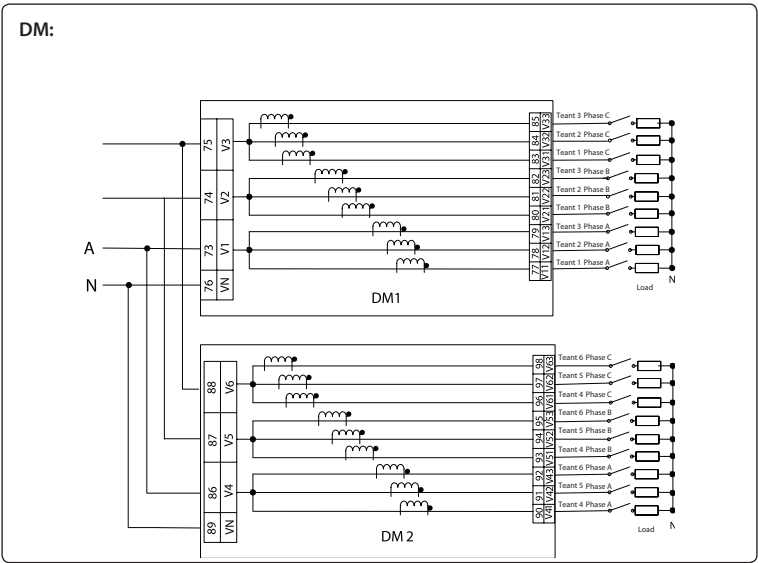

Figure 2-28 Three Phase 4 Out DM

3. Single phase 3 out(2LN)

EM:

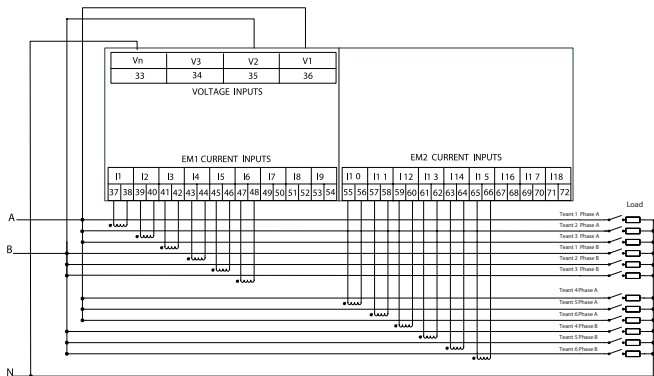

Figure 2-29 Single Phase 3 Out EM

DM:

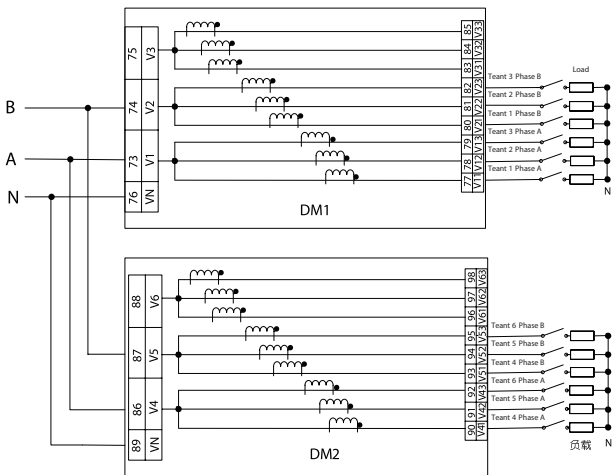

Figure 2-30 Single Phase 3 Out DM

Communication

AcuRev 2000 communication utilizes RS485 port, via Modbus-RTU protocol. The wiring terminals are A, B, S(1, 2, 3). "A" is called differential signal "+", "B" is called differential signal "-", "S" is connected to the shielding of shielded twisted pair cable. The maximum distance of Shielded Twisted Pair cable is 1200 m. The distance will be shorter if more devices are on the same communication link or using a higher baud rate.

If the master device does not have RS485 but RS232 port, a RS232/485 converter can be utilized. Typical RS485 network topologies include line, circle and star (wye).

In order to improve communication quality, please pay attention to:

1. High-quality Shielded Twisted Pair cable is very important, AWG22 (0.6mm²) or lower is recommended. Two cables should be different colors.
2. Pay attention to "single point earthing". It means there is only one point of the shielding connected to ground in a single communication link.
3. Every A(+) should be connected to A(+), B(-) to B(-), or it will influence the network, even damage the communication interface.
4. "T" type connection topology should be avoided. This means no new branches except from the starting point.
5. Keep communication cables away as much as possible from sources of electrical noise.

When several devices are connected (daisy chain) to the same long communication line, an anti signal reflecting resistor (typical value 1200- 3000Ohm, 0.25W) is often used at the end of the circuit (the last meter of the chain) if the communication quality is distorted.

6. Use RS232/RS485 or USB/RS485 converter with optical isolated output and surge protection.

7. A infrared port is also available in the Display Module, which supports meter reading. AcuRev 2000 also supports 10/100M Ethernet (optional), its protocol is ModBus TCP, SMTP, HTTP, SNMP, SNTF.

Chapter 3 Meter Display and Operation

3.1 Display Panel and Keys

3.2 Energy Display and Operation

3.3 Demand Display and Operation

3.4 I/O Display and Operation

3.5 Parameter Settings

3.6 Shortcut Code

3.7 Real-time Parameters

3.8 Device Information

3.9 Network Settings

3.10 Meter information and key operation

3.1 Meter Display and Operation

Chapter 2.1 shows the dimensions of Display Module. It consists of one LCD screen and five keys.

AcuRev 2000 innovative Display Module can be integrated into the meter base or the display module can also be mounted on the panel.

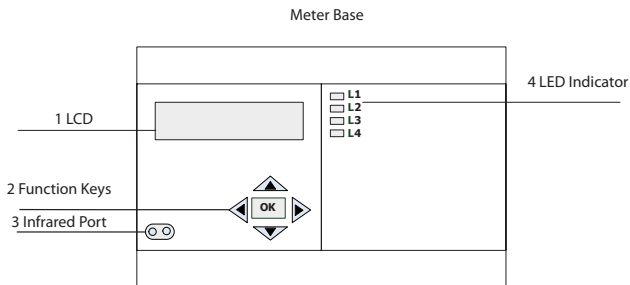

Figure 3-1 Display Module and LED Indicator

Function Keys:

Key		Function
▲	Up	Scroll up or increase value(Editing mode)
▼	Down	Scroll down or decrease value(Editing mode)
◀	Left	Decrease tenant number or move cursor to the left
▶	Right	Increase tenant number or move cursor to the Right
OK	Confirm	Show menu or confirmation

Table 3-1 Function Keys illustration

Key Combination

Holding "Left" and "right" at the same time is quick exit function, In any screen, press this key combination can return to the main menu screen, basic settings and network settings are only available with this key combination to return to the main menu screen.

Wiring type

The meter supports single-phase user (1LN) and three-phase four-line users (3LN) mixed use, single-phase user (1LN) and single-phase three-wire user (2LN) mixed use. In- line of all connection types according to the three-phase four-wire user (3LN) display.

Display Mode

Display company name "ACCUENERGY" in LCD screen when powered up, after 2 seconds entering the main menu screen automatically. Arrow keys to move the cursor position, "OK" button to confirm and enter the corresponding menu. If you enter "M" quick code screen, the left and right keys to move the cursor, up and down keys to change the value, the "OK" button to confirm and enter the corresponding screen.

Settings Mode

In the main menu screen, move the cursor to the setting icon, press “OK” to enter the settings mode. After the password screen, it will display language setting screen. Press “OK” to activate the cursor. When the cursor is inactive, arrow keys to scroll the screens. When the cursor is active, the cursor blinks, “Up” and “Down” to change the value where the cursor stays, “Left” and “Right” to move the cursor, “OK” is for confirmation.

LED indicator from top to bottom:

L1- Power Supply. Remains on when the meter is powered. Turns off when meter is not powered.

L2- Pulse Output 1.Blinking: E1 Pulse Output; Non-Blinking: no Pulse Output.

L3- Pulse Output 2.Blinking: E2 Pulse Output; Non-Blinking: no Pulse Output.

L4- Alarming. Blinking: when an alarm is triggered; Non-Blinking: no alarms.

Main menu first screen

Menu Display	Function
E(Energy)	Energy Measurement
D(Demand)	Demand Measurement
IO(IO)	Digital Input Output
MUL(Real-time)	Real-time
M	Obtain Cursor

Table 3-2 Main menu first screen

Main menu second screen (AcuRev 2010)

Menu Display	Function
SET	Basic Settings
NET	Network Settings
INFO	Device Information

Table 3-3 Main menu second screen

Main menu second screen(AcuRev 2020)

Menu Display	Function
PQ	Harmonic
SET	Basic Settings
NET	Network Settings
INFO	Device Information

Table 3-4 Main menu second screen(AcuRev 2020)

Main menu screen is shown in Table 3-2, the arrow keys to switch between menus.

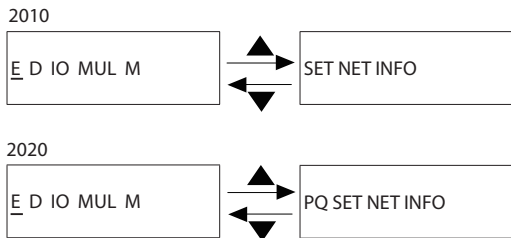

Table 3-2 Menu display

3.2 Energy Display and operation

On the first screen of main menu, select "E" by pressing "Left" and "Right", press "OK" to display energy. Press "Left" or "Right" to choose tenant and in line energy. Press "Up" and "Down" to select different screens. Press "OK" return to main menu screen.

If TOU energy is not used, it only displays real-time energy.

Parameter	Screen
Real-time energy	EP
This Month Total Energy	M TnS
This Month Tariff 1 Energy	MT1S
This Month Tariff 2 Energy	MT2S
This Month Tariff 3 Energy	MT3S
This Month Tariff 4 Energy	MT4S
Prior Month Total Energy	U TnS
Prior Month Tariff 1 Energy	UT1S
Prior Month Tariff 2 Energy	UT2S
Prior Month Tariff 3 Energy	UT3S
Prior Month Tariff 4 Energy	UT4S
Reactive energy	EQ
Apparent energy	ES

Table 3-6 Energy Display

Different wiring, energy data display is not the same, Inline default 3LN wiring, out-line has three ways: single-phase out (1LN), three-phase four-wire out (3LN), single-phase three-wire out (2LN), Details are as follows (AcuRev 2010 meter does not show the screen of yellow background):

1. Single Phase Out(1LN)

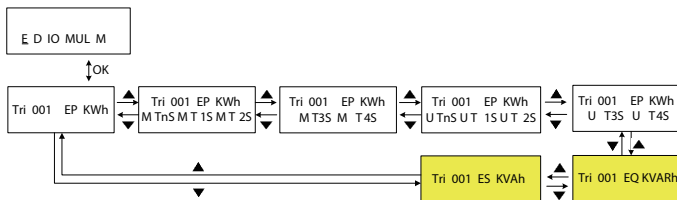

Figure 3-2 Single Phase Out energy display

2. Three Phase 4 Out (3LN)

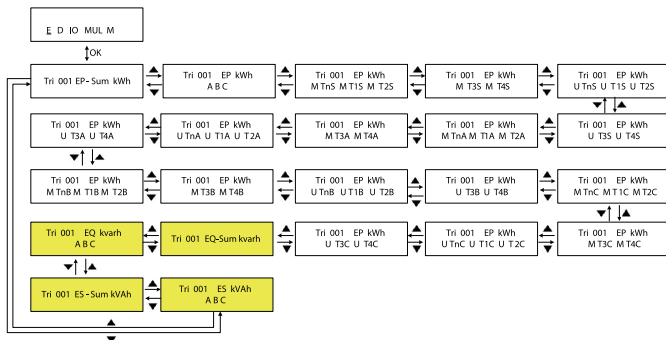

Figure 3-3 Three Phase 4 Out energy display

3. Single Phase 3 Out (2LN)

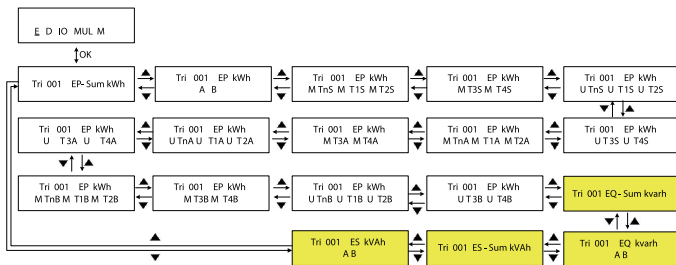

Figure 3-4 Single Phase 3 Out energy display

3.3 Demand Display and Operation

On the first page of the main menu, press "D", then press the "OK", the meter displays demands. "Left" and "Right" keys to select a different user or Inline. "Up" and "Down" keys to select the current user's different screen, press "OK" button to return to the main menu.

For AcuRev 2010, only displays the active power demand.

Parameter	Display
Demand	DMD
Active Demand	DMD-P
Reactive Demand	DMD-Q
Apparent Demand	DMD-S
Current Demand	DMD-I
Predicted Demand	Pre
Maximum Demand	Max

Table 3-7 Demand display

Different wiring, demand data display is not the same. Details are as follows (AcuRev 2010 meter does not show the screens of yellow background):

1. Single Phase Out(1LN)

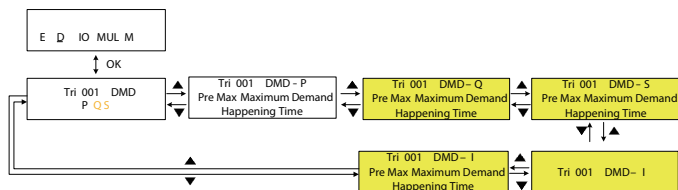

Figure 3-5 Single Phase Out demand display

2. Three Phase 4 Out (3LN)

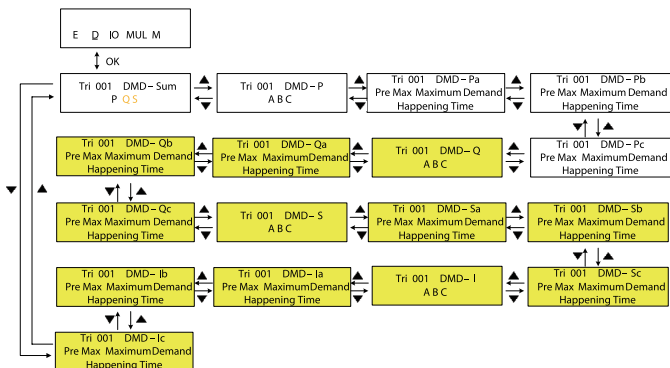

Figure 3-6 Three Phase 4 Out demand display

3. Single Phase 3 Out (2LN)

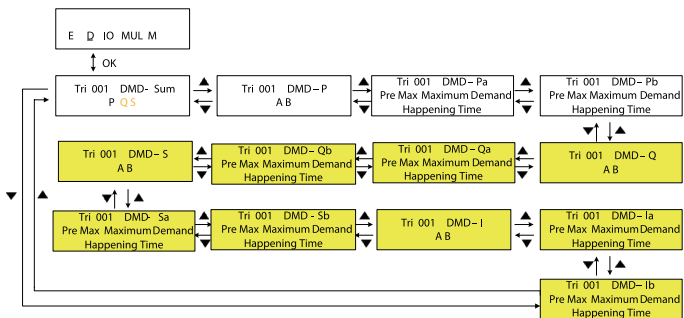

Figure 3-7 Single Phase 3 Out demand display

3.4 IO Display and Operations

On the first page of the main menu, press "left" and "right" to choose "IO" then press the center key, the meter displays IO data. "Up" and "Down" to select a different screen, the "OK" key to return to the main menu.

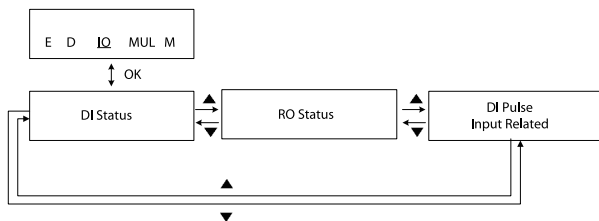

Figure 3-8 IO Display

1st screen, DI status, 8-channel DI

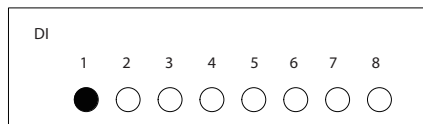
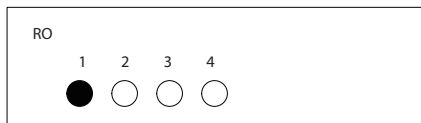

Figure 3-9 DI Display

- indicates this channel DI status "OFF" or Pulse Input
- indicates DI status "ON"

2nd screen, RO status, 4-channel RO



- indicates this channel RO status "OFF"
- indicates this RO status "ON"

Figure 3-10 RO Display

3rd screen, DI pulse input number and its parameter, press "Left" and "Right" to select different channel 1-8.

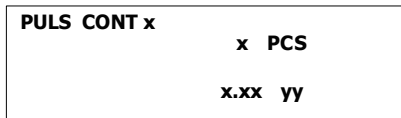

Figure 3-11 DI Pulse Input Display

CONT X indicates DI channel number

PCS indicates pulse number

yy indicates number, such as 6.15 m3 represents 6.15 m3

3.5 Real-time display and key operation

On the first screen of the main menu, select "MUL" (real-time), press the "OK" button, the meter displays real-time. "Left" and "right" keys to select a different user or inline, "up" and "down" keys to select the current user's different screen, the "OK" button to return to the main menu.

For Acurev2010, only display the active power.

Parameter	Screen Number
The total amount of time	MUL-Sum
Active power	MUL -P
Reactive power	MUL -Q
Apparent power	MUL -S
Real-time current value	MUL -I
Power Factor	MUL-PF
Nature of the load	MUL-Load Type
Phase voltage	MUL-Phase U

Phase voltage average	Uavg
Line voltage	MUL-Line U
Line voltage average	Uavg

Different wiring, Real-time display is not the same. Details are as follows (AcuRev 2010 meter does not show the screen of yellow background):

1. Single Phase Out(1LN)

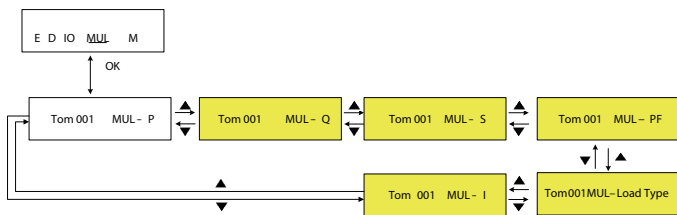

Figure 3-12 Single Phase Out real-time display

2. Three Phase 4 Out (3LN)

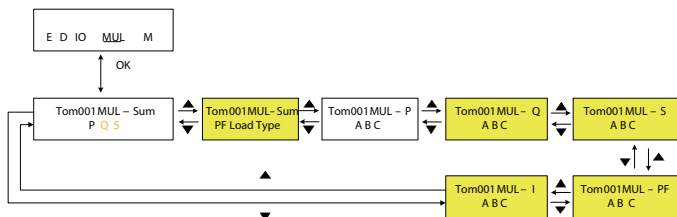

Figure 3-13 Three Phase 4 Out real-time display

3. Single Phase 3 Out (2LN)

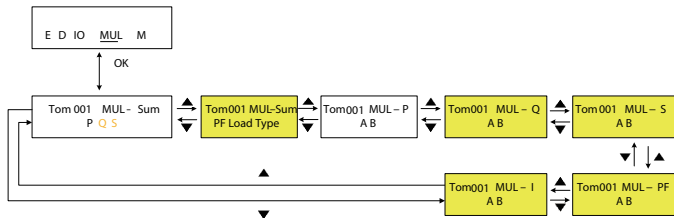

Figure 3-14 Single Phase 3 Out real-time display

4. Inline

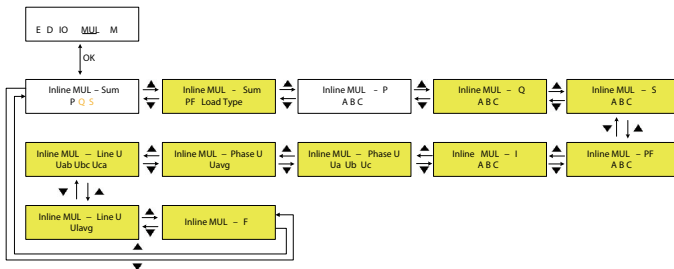

Figure 3-15 Inline real-time display

3.6 Shortcut Code

On the first screen of main page, press "Left" and "Right" keys to choose "M", then press the "OK" key to enter Shortcut Keys page.

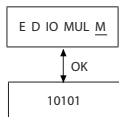

Figure 3-16

Press "Left" and "Right" to move the cursor to choose different digit. Press "Up" and "Down" key to change the digit value, after the input of Shortcut Code, press the center key to enter the corresponding pages.

Shortcut Code consists of five digits. The first digit on the left is to choose functions, as depicted in Table 3-8. 1 represents energy measurement, 2 represents demand measurement, 3 represents Digital Input Digital Output, 4 represents real-time, 5 represents Power Quality, all the other parameters do not have shortcut code.

Function	Shortcut
Energy Measurement	1
Demand Measurement	2
Digital Input Digital Output	3
Real-time Measurement	4
Power Quality	5

Left in the second and third digits are the number of selection screen, the right side, the first and the second is to select the user number. When user Settings screen number is not correct or the selected user number is not enabled, the connection mode of the display module based on user and instrument types and set up accordingly.

When user Settings screen number is not correct or the selected user number is not enabled, **the connection mode of the display module based on user and instrument types and set up accordingly.**

Tip "USER WRONG" indicating that the user is not enabled;

Tip "SCREEN WRONG" setting screen instructions when the number exceeds the limit or chose not to support the screen

Different connection types are also different codes, detailed shortcut code corresponding to the screen, please follow this swift code table:

1. Single Phase Out(1LN)

Note "*" to indicate that only Acurev2020 meter has feature

Note the "#" is enabled only content sharing

Funtion	Users	Screen Number	Code	Content	Note
Energy (No Time of Use, only real-time energy)	1~18	1	10101~10118	Real-time energy	
		2	10201~10218	This month total energy, this month tariff 1 energy, this month tariff 2 energy.	#
		3	10301~10318	This month tariff 3 energy, this month tariff 4 energy.	#
		4	1~18	Prior month total energy, prior month tariff 1 energy, prior month tariff 2 energy.	#
		5	10501~10518	Prior month tariff 3 energy, Prior month tariff 4 energy	#
		6	10601~10618	Reactive energy	*
		7	10701~10718	Apparent energy	*
Demand	1~18	1	20101~20118	Real power demand ,Reactive power demand, Apparent power demand	①
		2	20201~20218	Real Power Demand prediction, Real Power Demand Peak and happening time	

Demand	1~18	3	20301~20318	Reactive Power Demand prediction, Reactive Power Demand Peak and happening time	*
		4	20401~20418	Apparent Power Demand prediction, Apparent Power Demand Peak and happening time	*
		5	20501~20518	Current demand	*
		6	20601~20618	Current Demand prediction, Current Demand Peak and happening time	*
Digital Input and Digital Output	DI Channel 1~8	1	30101~30108	DI Status	
		2	30201~30208	RO Status	
		3	30301~30308	DI Pulse Input related	
Real-time	1~18	1	40101~40118	Real Power	
		2	40201~40218	Reactive power	*
		3	40301~40318	Apparent power	*
		4	40401~40418	Power Factor	*
		5	40501~40518	Load Type	*
			40601~40618	Current	*
Power Quality	1~18	1	50101~50118	Harmonic distortion, odd harmonic distortion, even harmonic distortion	*
		2	50201~50218	Current K-factor	*
		3	50301~50318	Harmonic of Current (2nd ~ 7th)	*
		4	50401~50418	Harmonic of Current (8th ~13th)	*
		5	50501~50518	Harmonic of Current (14th ~ 19th)	*
		6	50601~50618	Harmonic of Current (20th ~ 25th)	*
		7	50701~50718	Harmonic of Current (26th ~ 31st)	*

Note:

① Acurev2010 only include active power demand;

*: The instrument is Acurev2010, enter an asterisk zone function code when prompted
SCREEN WRONG

2. Three Phase 4 Out(3LN)

Description: 3LN number of screens begin to run from 21 to distinguish 1LN, 2LN

Note "*" to indicate that only Acurev2020 meter has feature

Note the "#" is enabled only content sharing

Function	Users	Screen Number	Code	Content	Note
Energy (No Time of Use, only real-time energy)	1~18	1	12101~12118	Total real energy	
		2	12201~12218	Phase A,B,C real energy	
		3	12301~12318	This month total power-sharing, this month tariff 1 energy, this month tariff 2 energy.	#
		4	12401~12418	This month tariff 3 energy, this month tariff 4 energy.	#
		5	12501~12518	Prior month total power-sharing, prior month tariff 1 energy, prior month tariff 2 energy.	#
		6	12601~12618	Prior month tariff 3 energy, prior month tariff 4 energy.	#
		7	12701~12718	Phase A this month total power-sharing. Phase A this month tariff 1 energy, Phase A this month tariff 2 energy.	#

Energy (No Time of Use, only real-time energy)	1~18	8	12801~12818	Phase A this month tariff 3 energy, Phase A this month tariff 4 energy.	#
		9	12901~12918	Phase A prior month total energy, Phase A prior month tariff 1 energy, Phase A prior month tariff 2 energy.	#
		10	13001~13018	Phase A prior month tariff 3 energy, Phase A prior month tariff 4 energy	#
		11	13101~13118	Phase B this month total energy. Phase B this month tariff 1 energy, Phase B this month tariff 2 energy.	#
		12	13201~13218	Phase B this month tariff 3 energy, Phase B this month tariff 4 energy.	#
		13	13301~13318	Phase B prior month total energy, Phase B prior month tariff 1 energy, Phase B prior month tariff 2 energy.	#
		14	13401~13418	Phase B prior month tariff 3 energy, Phase B prior month tariff 4 energy	#
		15	13501~13518	Phase C this month total energy. Phase C this month tariff 1 energy, Phase C this month tariff 2 energy.	#
		16	13601~13618	Phase C this month tariff 3 energy, Phase C this month tariff 4 energy.	#

Energy (No Time of Use, only real-time energy)	1~18	17	13701~13718	Phase C prior month total energy, Phase C prior month tariff 1energy, Phase C prior month tariff2 energy.	#
		18	13801~13818	Phase C prior month tariff 3 energy, Phase C prior month tariff 4 energy	#
		19	13901~13918	Total reactive energy	*
		20	14001~14018	Phase A,B,C reactive energy	*
		21	14101~14118	Total apparent energy	*
		22	14201~14218	Phase A,B,C apparent energy	*
Demand	1~18	1	22101~22118	System active power demand, System reactive power demand, System apparent power demand	①
		2	22201~22218	Phase A,B,C active power demand	
		3	22301~22318	Phase A Real Power Demand prediction, Phase A Real Power Demand Peak and happening time	
		4	22401~22418	Phase B Real Power Demand prediction, Phase B Real Power Demand Peak and happening time	
		5	22501~22518	Phase C Real Power Demand prediction, Phase C Real Power Demand Peak and happening time	
		6	22601~22618	Phase A,B,C Reactive power demand	*

Demand	1~18	7	22701~22718	Phase A Reactive Power Demand prediction, Phase A Reactive Power Demand Peak and happening time	*
		8	22801~22818	Phase B Reactive Power Demand prediction, Phase B Reactive Power Demand Peak and happening time	*
		9	22901~22918	Phase C Reactive Power Demand prediction, Phase C Reactive Power Demand Peak and happening time	*
		10	23001~23018	Phase A,B,C Apparent power demand	*
		11	23101~23118	Phase A Apparent Power Demand prediction, Phase A Apparent Power Demand Peak and happening time	*
		12	23201~23218	Phase B Apparent Power Demand prediction, Phase B Apparent Power Demand Peak and happening time	*
		13	23301~23318	Phase C Apparent Power Demand prediction, Phase C Apparent Power Demand Peak and happening time	*
		14	23401~23418	Phase A,B,C Current demand	*
		15	23501~23518	Phase A Current Demand prediction, Phase A Current Demand Peak and happening time	*

Demand	1~18	16	23601~23618	Phase B Current Demand prediction, Phase B Current Demand Peak and happening time	*
		17	23701~23718	Phase C Current Demand prediction, Phase C Current Demand Peak and happening time	*
Digital Input and Digital Output	DI Channel 1~8	1	30101~30108	DI Status	
		2	30201~30208	RO Status	
		3	30301~30308	DI Pulse Input related	
Real-time	1~18	1	42101~42118	Total Active Power, Total Reactive Power, Total Apparent Power	②
		2	42201~42218	Total Power Factor, Total Load Type	*
		3	42301~42318	Phase A, B, C, Active Power	
		4	42401~42418	Phase A, B, C, Reactive Power	*
		5	42501~42518	Phase A, B, C, Apparent Power	*
		6	42601~42618	Phase A, B, C, Power Factor	*
		7	42701~42718	Phase A, B, C, Current	*
Power Quality	1~18	1	52101~52118	Current unbalance	*
		2	52201~52218	Phase A harmonic distortion, odd harmonic distortion, even harmonic distortion	*
		3	52301~52318	Phase B harmonic distortion, odd harmonic distortion, even harmonic distortion	*
		4	52401~52418	Phase C harmonic distortion, odd harmonic distortion, even harmonic distortion	*
		5	52501~52518	Current K-factor	*

Power Quality	1~18	6	52601~52618	Harmonic of Phase A Current(2nd ~7th)	*
		7	52701~52718	Harmonic of Phase A Current (8th~13th)	*
		8	52801~52818	Harmonic of Phase A Current (14th~19th)	*
		9	52901~52918	Harmonic of Phase A Current (20th~25th)	*
		10	53001~53018	Harmonic of Phase A Current(26th~31st)	*
		11	53101~53118	Harmonic of Phase B Current (2nd ~7th)	*
		12	53201~53218	Harmonic of Phase B Current(8th~13th)	*
		13	53301~53318	Harmonic of Phase B Current (14th~19th)	*
		14	53401~53418	Harmonic of Phase B Current(20th~25th)	*
		15	53501~53518	Harmonic of Phase B Current (26th~31st)	*
		16	53601~53618	Harmonic of Phase C Current (2nd ~7th)	*
		17	53701~53718	Harmonic of Phase C Current (8th~13th)	*
		18	53801~53818	Harmonic of Phase C Current(14th~19th)	*
		19	53901~53918	Harmonic of Phase C Current (20th~25th)	*
20	54001~54018	Harmonic of Phase C Current (26th~31st)	*		

Note:

- ① Acurev 2010 only include active power demand;
- ② Acurev 2010 only include active power

*: The instrument is Acurev2010, enter an asterisk zone function code when prompted
SCREEN WRONG

3. Single Phase 3 Out(2LN)

Description: 2LN number of screens begin to run from 61 to distinguish 1LN, 3LN

Note '*' to indicate that only Acurev2020 meter has feature

Note the "#" is enabled only content sharing

Function	Users	Screen Number	Code	Content	Note
Energy (No Time of Use, only real-time energy)	1~18	1	16101~16118	Real-time energy	
		2	16201~16218	Phase A,B real-time energy	
		3	16301~16318	This month total power-sharing, this month tariff 1 energy, this month tariff 2 energy.	#
		4	16401~16418	This month tariff 3 energy, this month tariff 4 energy.	#
		5	16501~16518	Prior month total power-sharing, prior month tariff 1 energy, prior month tariff 2 energy.	#
		6	16601~16618	Prior month tariff 3 energy, prior month tariff 4 energy.	#

Energy (No Time of Use, only real-time energy)	1~18	7	16701~16718	Phase A this month total energy, Phase A this month tariff 1 energy, Phase A this month tariff 2 energy.	#
		8	16801~16818	Phase A this month tariff 3 energy, Phase A this month tariff 4 energy.	#
		9	16901~16918	Phase A prior month total energy, Phase A prior month tariff 1 energy, Phase A prior month tariff 2 energy.	#
		10	17001~17018	Phase A prior month tariff 3 energy, Phase A prior month tariff 4 energy	#
		11	17101~17118	Phase B this month total energy, Phase B this month tariff 1 energy, Phase B this month tariff 2 energy.	#
		12	17201~17218	Phase B this month tariff 3 energy, Phase B this month tariff 4 energy.	#
		13	17301~17318	Phase B prior month total energy, Phase B prior month tariff 1 energy, Phase B prior month tariff 2 energy.	#
		14	17401~17418	Phase B prior month tariff 3 energy, Phase B prior month tariff 4 energy	#
		15	17501~17518	Total reactive energy	*
		16	17601~17618	Phase A,B, reactive energy	*
		17	17701~17718	Total apparent energy	*
		18	17801~17818	Phase A,B, apparent energy	*

Demand	1~18	1	26101~26118	System active power demand, System reactive power demand, System apparent power demand	①
		2	26201~26218	Phase A,B, active power demand	
		3	26301~26318	Phase A Real Power Demand prediction, Phase A Real Power Demand Peak and happening time	
		4	26401~26418	Phase B Real Power Demand prediction, Phase B Real Power Demand Peak and happening time	
		5	26501~26518	Phase A,B, Reactive power demand	*
		6	26601~26618	Phase A Reactive Power Demand prediction, Phase A Reactive Power Demand Peak and happening time	*
		7	26701~26718	Phase B Reactive Power Demand prediction, Phase B Reactive Power Demand Peak and happening time	*
		8	26801~26818	Phase A,B, Apparent power demand	*
		9	26901~26918	Phase A Apparent Power Demand prediction, Phase A Apparent Power Demand Peak and happening time	*
		10	27001~27018	Phase B Apparent Power Demand prediction, Phase B Apparent Power Demand Peak and happening time	*

Demand	1~18	11	27101~27118	Phase A,B, Current demand	*
		12	27201~27218	Phase A Current Demand prediction, Phase A Current Demand Peak and happening time	*
		13	27301~27318	Phase B Current Demand prediction, Phase B Current Demand Peak and happening time	*
Digital Input and Digital Output	DI Channel 1~8	1	30101~30108	DI Status	
		2	30201~30208	RO Status	
		3	30301~30308	DI Pulse Input related	
Real-time	1~18	1	46101~46118	Total Active Power, Total Reactive Power, Total Apparent Power	③
		2	46201~46218	Total Power Factor, Total Load Type	*
		3	46301~46318	Phase A, B, Active Power	
		4	46401~46418	Phase A, B, Reactive Power	*
		5	46501~46518	Phase A, B, Apparent Power	*
		6	46601~46618	Phase A, B, Power Factor	*
		7	46701~46718	Phase A, B, Current	*
Power Quality	1~18	1	56101~56118	Current unbalance	*
		2	56201~56218	Phase A harmonic distortion, odd harmonic distortion, even harmonic distortion	*
		3	56301~56318	Phase B harmonic distortion, odd harmonic distortion, even harmonic distortion	*
		4	56401~56418	Current K-factor	*
		5	56501~56518	Harmonic of Phase A Current(2nd ~7th)	*

Power Quality	1~18	6	56601~56618	Harmonic of Phase A Current (8th~13th)	*
		7	56701~56718	Harmonic of Phase A Current (14th~19th)	*
		8	56801~56818	Harmonic of Phase A Current (20th~25th)	*
		9	56901~56918	Harmonic of Phase A Current(26th~31st)	*
		10	57001~57018	Harmonic of Phase B Current (2nd ~7th)	*
		11	57101~57118	Harmonic of Phase B Current(8th~13th)	*
		12	57201~57218	Harmonic of Phase B Current (14th~19th)	*
		13	57301~57318	Harmonic of Phase B Current(20th~25th)	*
		14	57401~57418	Harmonic of Phase B Current (26th~31st)	*

Note:

① Acurev2010 only include active power demand;

② Acurev2010 only include active power

*: The instrument is Acurev2010, enter an asterisk zone function code when prompted
SCREEN WRONG

4. Inline

Note "*" to indicate that only Acurev2020 meter has feature

Note the "#" is enabled only content sharing

Function	Users	Screen Number	Code	Content	Note
Energy (No Time of Use, only real-time energy)	Inline	1	10100	System active energy	
		2	10200	Phase A,B,C active energy	
		3	10300	System this month total energy. System this month tariff 1 energy, System this month tariff 2 energy.	#
		4	10400	System this month tariff 3 energy, System this month tariff 4 energy.	#
		5	10500	System prior month total energy, System prior month tariff 1 energy, System prior month tariff 2 energy.	#
		6	10600	System prior month tariff 3 energy, System prior month tariff 4 energy	#
		7	10700	Phase A this month total energy. Phase A this month tariff 1 energy, Phase A this month tariff 2 energy.	#
		8	10800	Phase A this month tariff 3 energy, Phase A this month tariff 4 energy.	#
		9	10900	Phase A prior month total energy, Phase A prior month tariff 1 energy, Phase A prior month tariff 2 energy.	#
		10	11000	Phase A prior month tariff 3 energy, Phase A prior month tariff 4 energy	#

Energy (No Time of Use, only real-time energy)	Inline	11	11100	Phase B this month total energy. Phase B this month tariff 1 energy, Phase B this month tariff 2 energy.	#
		12	11200	Phase B this month tariff 3 energy, Phase B this month tariff 4 energy.	#
		13	11300	Phase B prior month total energy, Phase B prior month tariff 1 energy, Phase B prior month tariff 2 energy.	#
		14	11400	Phase B prior month tariff 3 energy, Phase B prior month tariff 4 energy	#
		15	11500	Phase C this month total energy. Phase C this month tariff 1 energy, Phase C this month tariff 2 energy.	#
		16	11600	Phase C this month tariff 3 energy, Phase C this month tariff 4 energy.	#
		17	11700	Phase C prior month total energy, Phase C prior month tariff 1 energy, Phase C prior month tariff 2 energy.	#
		18	11800	Phase C prior month tariff 3 energy, Phase C prior month tariff 4 energy	#
		19	11900	System reactive energy	*
		20	12000	Phase A,B C reactive energy	*
		21	12100	System apparent energy	*
		22	12200	Phase A,B C apparent energy	*

Demand	Inline	1	20100	System active power demand, System reactive power demand, System apparent power demand (Acurev2010 only has active power demand)	①
		2	20200	Phase A, B, C active power demand	
		3	20300	Phase A Real Power Demand prediction, Phase A Real Power Demand Peak and happening time	
		4	20400	Phase B Real Power Demand prediction, Phase B Real Power Demand Peak and happening time	
		5	20500	Phase C Real Power Demand prediction, Phase C Real Power Demand Peak and happening time	
		6	20600	Phase A,B,C Reactive power demand	*
		7	20700	Phase A Reactive Power Demand prediction, Phase A Reactive Power Demand Peak and happening time	*
		8	20800	Phase B Reactive Power Demand prediction, Phase B Reactive Power Demand Peak and happening time	*
		9	20900	Phase C Reactive Power Demand prediction, Phase C Reactive Power Demand Peak and happening time	*

Demand	Inline	10	21000	Phase A,B,C Apparent power demand	*
		11	21100	Phase A Apparent Power Demand prediction, Phase A Apparent Power Demand Peak and happening time	*
		12	21200	Phase B Apparent Power Demand prediction, Phase B Apparent Power Demand Peak and happening time	*
		13	21300	Phase C Apparent Power Demand prediction, Phase C Apparent Power Demand Peak and happening time	*
		14	21400	Phase A,B,C Current demand	*
		15	21500	Phase A Current Demand prediction, Phase A Current Demand Peak and happening time	*
		16	21600	Phase B Current Demand prediction, Phase B Current Demand Peak and happening time	*
		17	21700	Phase C Current Demand prediction, Phase C Current Demand Peak and happening time	*
Digital Input and Digital Output	DI channel 1~8	1	30101~30108	DI Status	
		2	30201~30208	RO Status	
		3	30301~30308	DI Pulse Input related	
		1	40100	System Active Power, System Reactive Power, System Apparent Power	Ⓢ
		2	40200	System Power Factor, System Load Type	*

Real-time	Inline	3	40300	Phase A, B, C, Active Power			
		4	40400	Phase A, B, C, Reactive Power	*		
		5	40500	Phase A, B, C, Apparent Power	*		
		6	40600	Phase A, B, C, Power Factor	*		
		7	40700	Phase A, B, C, Current	*		
		8	40800	Phase A, B, C phase voltage	*		
		9	40900	Phase A, B, C average of phase voltage	*		
		10	41000	Phase A, B, C line voltage	*		
		11	41100	Phase A, B, C average of line voltage	*		
		12	41200	Voltage Frequency	*		
		Power Quality	Inline	1	50100	Voltage unbalance	*
				2	50200	Phase A harmonic distortion, odd harmonic distortion, even harmonic distortion	*
3	50300			Phase B harmonic distortion, odd harmonic distortion, even harmonic distortion	*		
4	50400			Phase C harmonic distortion, odd harmonic distortion, even harmonic distortion	*		
5	50500			Average voltage of harmonic distortion	*		
6	50600			Crest Factor	*		
7	50700			Telephone harmonic form factor	*		
8	50800			Harmonic of Phase A Current(2nd ~7th)	*		
9	50900			Harmonic of Phase A Current (8th~13th)	*		
10	51000			Harmonic of Phase A Current (14th~19th)	*		
11	51100			Harmonic of Phase A Current (20th~25th)	*		

		12	51200	Harmonic of Phase A Current(26th~31st)	*
		13	51300	Harmonic of Phase B Current (2nd ~7th)	*
		14	51400	Harmonic of Phase B Current(8th~13th)	*
		15	51500	Harmonic of Phase B Current (14th~19th)	*
		16	51600	Harmonic of Phase B Current(20th~25th)	*
		17	51700	Harmonic of Phase B Current (26th~31st)	*
		18	51800	Harmonic of Phase C Current (2nd ~7th)	*
		19	51900	Harmonic of Phase C Current (8th~13th)	*
		20	52000	Harmonic of Phase C Current(14th~19th)	*
		21	52100	Harmonic of Phase C Current (20th~25th)	*
		22	52200	Harmonic of Phase C Current (26th~31st)	*

Note:

- ①Acurev2010 only include active power demand;
- ②Acurev2010 only include active power

*: The instrument is Acurev2010, enter an asterisk zone function code when prompted SCREEN WRONG

3.7 Power quality display and key operation

For AcuRev 2010, no power quality menu.

In the second page of the main menu, select "PQ" (quality), press the "OK" button to begin the display of power quality data. "Left" and "right" keys to select a different user or into the line, "up" and "down" keys to select the current user's different screen, the Enter key to return to the main menu.

Table3-9 Power quality display

Parameter	Display
Unbalance	UNBL
Harmonic distortion	THD
Total harmonic distortion	SUM
Odd harmonic distortion	ODD
Even harmonic distortion	EVEN
K-factor	K Factor
Crest Factor	Crest Factor
Telephone interference factor	THFF
Harmonic ratio	HARMONIC

Different wiring, current quality data display is not the same. Details are as follows (AcuRev 2010 meter does not show the screen of yellow background):

1. Single Phase Out(1LN)

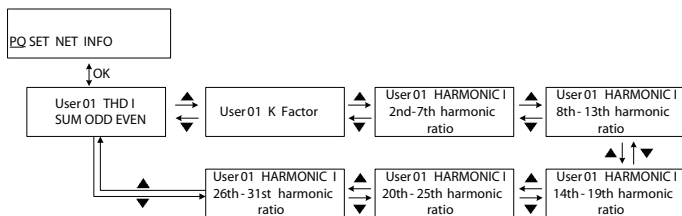

Figure 3-17 Single-phase power quality

2. Three Phase 4 Out(3LN)

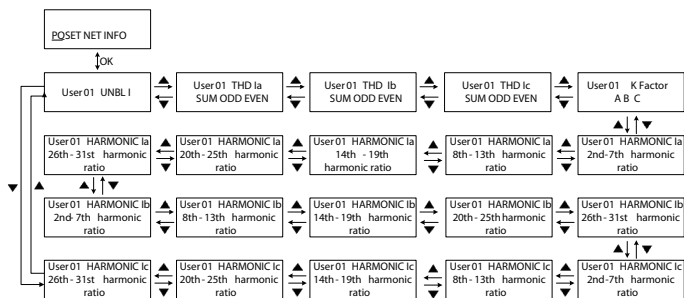

Figure 3-18 Three phase 4 out power quality

3. Single phase 3 Out(2LN)

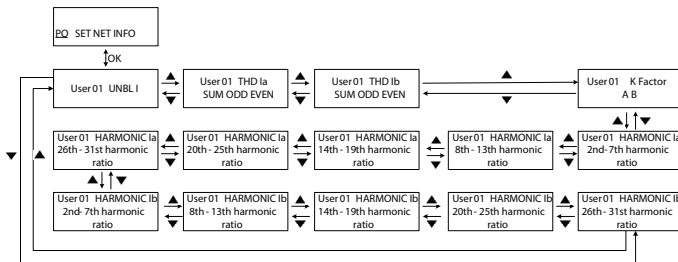

Figure 3-19 Single phase 3 out power quality

4. Inline

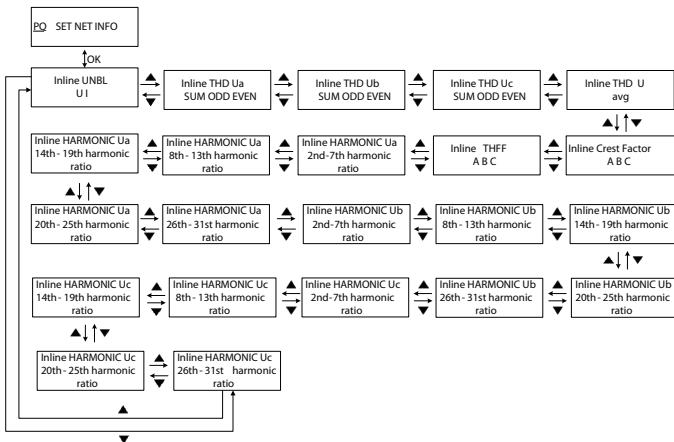

Figure 3-20 Inline power quality

3.8. Basic settings and key operation

In the second page of the main menu, select "SET", press the "OK" button, the password inquiry is passed, display language setting interface, the "OK" key to activate the cursor, the cursor is activated, the cursor blinks. When the cursor is not activated, the arrow keys to scroll; when the cursor is activated, the up and down keys to change the value at the cursor, left and right keys to move the cursor, the "OK" button to confirm the changes and stop the cursor. Combination of keys (left and right keys pressed together) to return to the main menu.

When the meter using the DM module, then no CT setting interface set interface; when the meter type is Acurev2010, the basic interface is not (P25) reactive power calculation methods setting interface and (P26) load protocol selection interface.

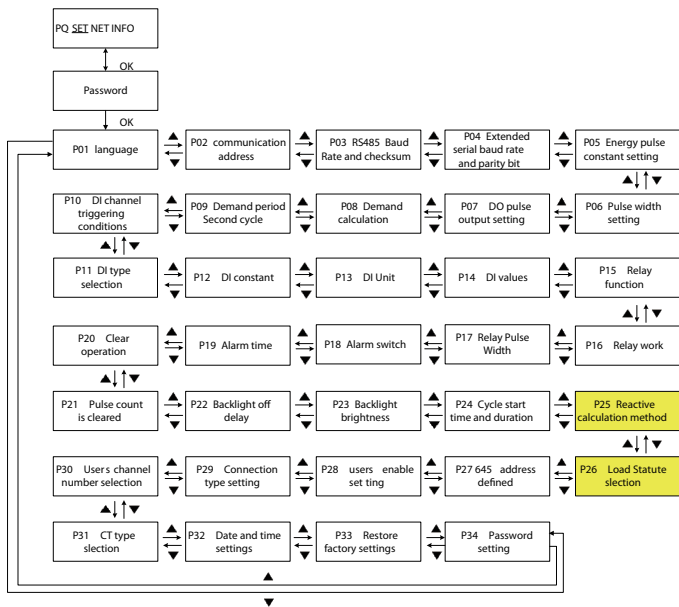

Figure 3-21 basic settings screen

P04 extended serial baud rate and parity settings are infrared meter display module baud rate and parity bit is set; DI constant represents the input number of pulses counted once. DI units represent physical unit that DI count value representing, there are five kinds: t , m^3 , kWh, ‰ , ‰ . DI values represent physical quantity that pulses counted once representing. P33 restore factory setting meaning the user's name, mapping relationship, wiring, CT type revert to the default values.

Select the channel number: For each user corresponding physical channel mapping, mapping relationship in the following table.

Parameter Setting	Corresponding physical channel		
	1LN	3LN	2LN
1	Channel 1	Channel 1	Channel 1
2	Channel 2	Channel 2	Channel 2
3	Channel 3	Channel 3	Channel 3
4	Channel 4	Channel 4	Channel 4
5	Channel 5	Channel 5	Channel 5
6	Channel 6	Channel 6	Channel 6
7	Channel 7	Channel 7	Channel 7
8	Channel 8	Channel 8	Channel 8
9	Channel 9	Channel 9	Channel 9
10	Channel 10	Channel 10	Channel 10
11	Channel 11	Channel 11	Channel 11
12	Channel 12	Channel 12	Channel 12
13	Channel 13	Channel 13	Channel 13
14	Channel 14	Channel 14	Channel 14
15	Channel 15	Channel 15	Channel 15
16	Channel 16	Channel 16	Channel 16
17	Channel 17	Channel 17	Channel 17
18	Channel 18	Channel 18	Channel 18
19	--	Channel 1 Channel 4 Channel 7	Channel 1 Channel 4
20	--	Channel 2 Channel 5 Channel 8	Channel 2 Channel 5
21	--	Channel 3 Channel 6 Channel 9	Channel 3 Channel 6

22	--	Channel 10 Channel 13 Channel 16	Channel 10 Channel 13
23	--	Channel 11 Channel 14 Channel 17	Channel 11 Channel 14
24	--	Channel 12 Channel 15 Channel 18	Channel 12 Channel 15

3.9 Network Settings

In the second page of the main menu, select "NET"; press "OK" button to enter the password screen, the password authentication is passed into the network settings screen. When the cursor is not enabled, the arrow keys to scroll, when you press the "OK" button to move the cursor starts blinking, left and right keys to switch cursor positions, up and down keys to set the value of the parameter. After setting parameters, press the "OK" button to set parameters success while the cursor is no longer flashing. Combination of keys (left and right keys pressed together) to return to the main menu.

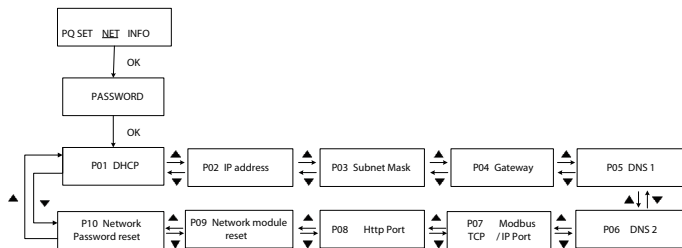

Figure 3-22 Network setting display

P01 DHCP represents DHCP address allocation mode setting, MANU (static allocation) and AUTO (dynamic allocation); P09 network module reset options include not reset, reset network module and restore the default parameters and reset the network module

Network module. Network settings only apply to network module, after setting each network module needs to be reset before work.

3.10 Meter information and key operation

In the second page of the main menu, select "INFO" (message), press the "OK" button to start the meter information display. Arrow keys to scroll, press the "OK" button to return to the main menu.

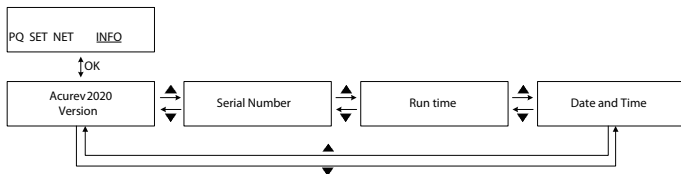

Figure 3-23 Meter information display

Chapter 4 Functions and Software

4.1 Basic Parameter Functions

4.2 IO Functions

4.3 Demand

4.4 Energy

4.5 Sequence of Events(SOE)

4.6 Over/Under Limit Alarming

4.7 System Event

4.8 Trending Record

4.9 Seal Function

4.10 Device Information

This chapter introduces AcuRev 2000 Utility Software.

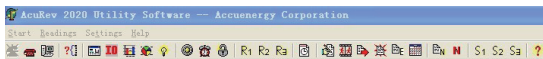

Figure 4-1 AcuRev 2000 Utility Software interface

General Setting, users and CTsetting must be configured properly in order to have AcuRev 2000 operate normally.

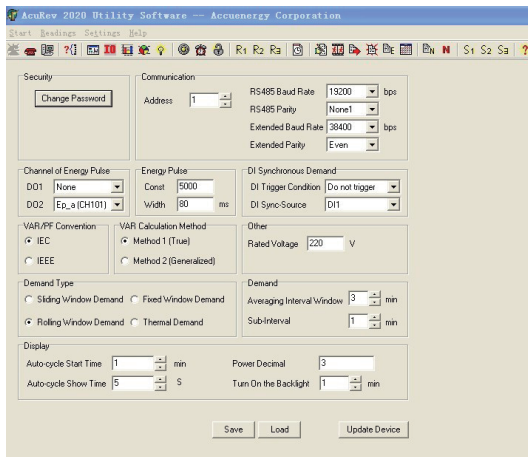

Figure 4-2 General Settings in the software

Energy pulse output setting: energy pulse settings include Pulse Constant and Pulse Width. Pulse Constant's range is 500-20000, Pulse Width range is 20-100ms. In practical applications, Pulse Constant and Pulse Width should be set according to the system's real power, otherwise it will influence the system's energy accuracy.

$$\text{Pulse Period} = 3600000 / (\text{Real Power} \times \text{Pulse Constant})$$

$$\text{Pulse Period} > \text{Pulse Width}$$

The following equation must be fulfilled in order to ensure the energy accuracy, the unit of Real Power is kW, Pulse Width is ms.

$$3600000 / (\text{Real Power} \times \text{Pulse Constant}) > \text{Pulse Width}$$

For example, if the Real Power is 35.2 kW, Pulse Width = $3600000 / (35.2 \times \text{Pulse Constant})$, it must meet $3600000 / (35.2 \times \text{Pulse Constant}) > \text{Pulse Width}$.

Note: The voltage rating is set for alarm, as the voltage rating in the alarm settings.

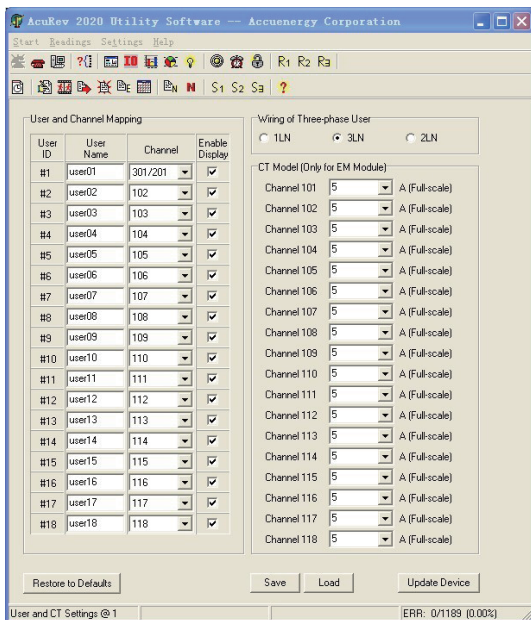

Figure 4-3 User and CT Settings display

About user name and the corresponding channel are described below:

- The user name can be customized, supports up to six (only supports letters and numbers)
- correspondence between the 101-118 refers to the physical channel 1-18 road 301/201-306/206 phase refers to the user's physical channel corresponding

c) If either one is not used, you can set the corresponding channel is not displayed (i.e.: remove allowed to display on the hook)

CT model as follows:

When using EM modules: Different channels can access different types transformers, as required by the customer can be independently set.

For example: The first one username Jack01, wiring is 3LN, the first channel phase (composed by the channel 1,4,7); following settings the # 1 users change the name of Jack01, the corresponding channel is set to 301/201 , check allows the display, the user's wiring phase change 3LN.

Note: after the setup, "Update Device" must be clicked in order to send the settings to the meter. All the other setting operations should follow this as well.

4.1 Basic Parameter Functions

The basic parameters measured in the AcuRev 2000 are voltage, current, power, etc. The base module only displays power, including system power, inline A, B, C power, and each tenant's power. Different wiring methods lead to different displays. The following figure is the display of basic parameter measurement (take the first one 3LN wiring for instance).

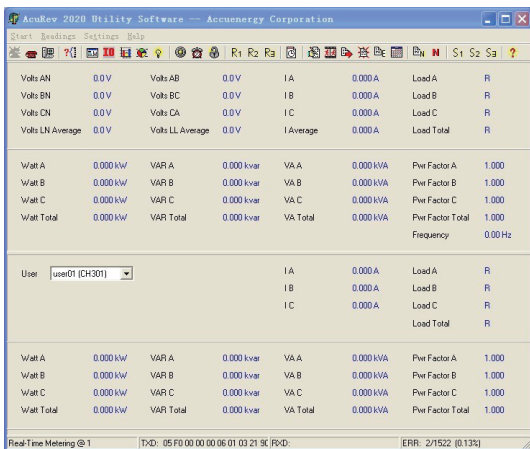

Figure 4-4 AcuRev 2020 Basic Measurement Parameter Display

Note: the “user” above is optional, select the user name to be displayed, The user divides the screen into two parts: the upper part is the inline power, the lower part is the user power. When wiring is set differently, gray data is invalid.

In the upper display, Pa represents Phase A Power; In the lower display, Pa (N) represents the N-th tenant’s Phase A power. The power accuracy is 0.5 %, with 4 decimal places.

4.2 IO Functions

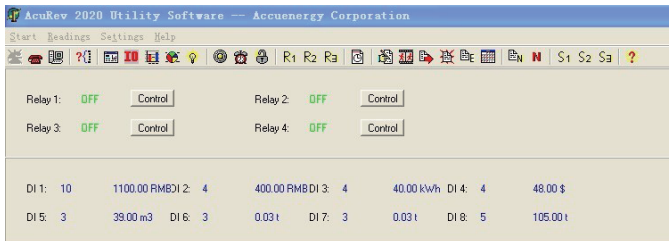

Figure 4-5 DI/RO

As Figure 4-5 shows, AcuRev 2000 has 4 Relay Outputs (RO), 8 Digital Inputs (DO). Please refer to Figure 4-6 for DI/RO related settings.

RO

Each channel RO can be configured as Relay Control or Alarm Output.

- (1) Relay Control: Latching or Pulse; Pulse width can be set between 50 and 3000 ms.
- (2) Alarm Output

There are two Alarm Output types: Over/Under Limit Alarming and System Event Alarming, the two can be active at the same time. Over/Under Limit Alarming will be introduced in detail later.

There are 12 events for system event alarming, which are:

1. Reset
2. Demand DI Synchronization
3. Demand Command Synchronization

4. Energy Clear
5. Running Hour Clear
6. Battery Runtime Clear
7. System Parameter Change
8. Initialized Energy Set
9. TOU Energy Change
10. System Clock Change
11. Reversed Power Direction
12. DI Pulse Counter Clear

These 12 events can enable the output of Relay 1 to Relay 4 for alarming. The time delay for alarming signal is 1-60000 s (the Relay Output status will latch for that amount of time).

If the Relay Output type is set as Relay Control, click "Control" in Figure 4-5 to send command "close" or "open" to the relay. When the relay is set as alarming output, Relay Control function will be disabled.

DI Function

DI type: Signal Status; Pulse Counter

DI unit and category: s (second), m3 (cubic meters), kWh (energy), RMB (Renminbi), \$ (dollar).

When DI type is set as Signal Status, it monitors the input status, providing all DI status. High level displays as "ON", low level displays as "OFF".

When DI type is set as Pulse Counter, it counts the input pulses. The Pulse Counter settings include Pulse Constant (how many pulses equals one count), Category and Unit, Value

(Category multiplied by the count number). The display panel displays the number corresponding to the pulse, as well as the calculated value.

For instance, if set 10 pulses = one count, one count represents 5 kWh. When 100 pulses are input, the display panel will display Number = 100/10=10, 10*5=50 kWh.

The screenshot shows the 'AccuRev 2000 Utility Software' window with the 'Settings' tab selected. The interface is divided into several sections for configuring digital inputs and outputs.

DI Type: This section contains eight rows (DI1 to DI8). Each row has a 'Counter' dropdown set to 'Counter', a 'Pulse' field set to '1', a '1 Unit = ' field with a value (e.g., 110.00 for DI1), a unit dropdown (e.g., 'RMB' for DI1), and a 'Clear' button.

RO Type: This section contains four rows (RO1 to RO4). Each row has a 'Relay Control' dropdown.

RO Output Mode: This section contains four rows (RO1 to RO4). Each row has a 'Latch' dropdown. Below these rows is an 'RO Pulse Width' field set to '90' ms.

System Event Alarming: This section has two columns: 'Enable' and 'Output'. It lists various events with checkboxes in the 'Enable' column and dropdown menus in the 'Output' column. The events listed are: Reset, DI Synchronization Demand, Command Synchronization Demand, Reset Energy, Reset Device Run-Time, Reset Setback Run-Time, Modify System Parameters, Set Initial Energy, Modify TOD Settings, Modify Clock, Reverse Power, and Reset DI Pulse Counter. All 'Enable' checkboxes are currently unchecked, and all 'Output' dropdowns are set to 'Relay 1'.

At the bottom of the window, there is an 'RO Alarm Output Time' field set to '60' s, and three buttons: 'Save', 'Load', and 'Update Device'.

Figure 4-6 DI/RO and System Event alarming setup

DO Function

AcuRev 2000 has 4 DO output

2-channel energy pulse output, the two channel can be used to send out independant energy pulses (see Appendix B), Pulse Constant, Pulse Width can be set. Tenant Number, Pulse Constant and Pulse Width settings can be implemented as Figure 4-2 shows.

1 channel demand cycle pulse output.

1 channel second pulse output is used to check the system clock's accuracy, or used to be the benchmark of time for the other equipment.

4.3 Demand

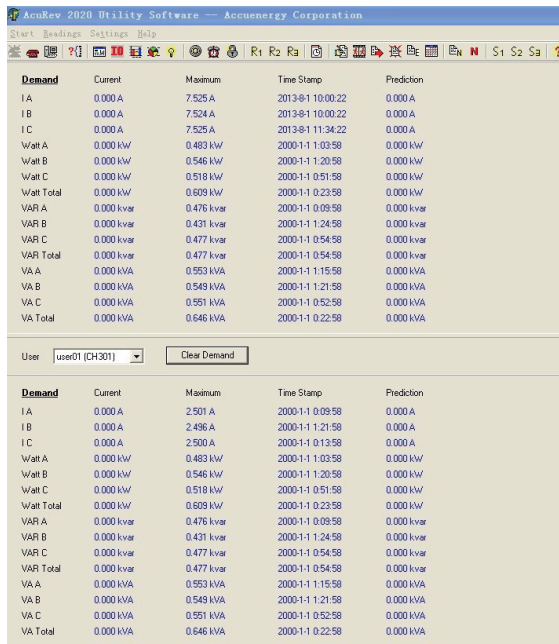

Figure 4-7 Demand

Display Demand, Max Demand, Max Demand Time, Demand Prediction (update per second) of the real power. The users is selective. The users divides the software window into two parts, the upper part indicates the demand related parameters, the lower part indicates the demand of each individual tenant.

Demand calculation has four methods: Sliding Window method, Fixed Window method, Rolling Window method and Thermal method. Users can set the demand period (1-30 minutes)and secondary demand period (1-30 minutes)according to different calculation methods. All related settings can be found in Figure 4-2.

Support Demand Synchronization

Method: Synchronizing with DI; Synchronizing with Command

DI Synchronization: DI triggering can be chosen as no triggering, triggered by rising edge, triggered by falling edge, triggered by changes. DI Synchronization source can set as DI1-DI8.The Synchronizing with DI settings is in Figure 4-2.

The Synchronizing with Command: choose "Clear Demand" in Figure 4-7.

Demand cycle or secondary cycle finishing signal can be sent out by DO.

4.4 Energy

Time of Use bi-directional real energy measurement. It saves up to 2 months energy data, data saving boundary time can be any specified day (auto meter reading day) between 1 and 28.The factory default is at 0 o'clock the first day of each month.

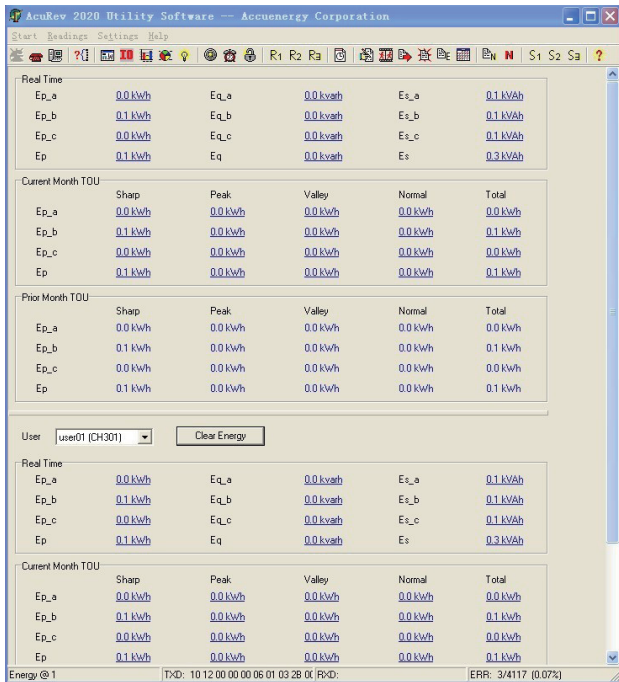

Figure 4-8 Energy

Displays real-time energy, this month TOU energy, prior month TOU energy, individual tenant real-time energy, this month individual tenant TOU energy, prior month individual tenant energy, Critical-peak, On-peak, Mid-peak, Off-peak energy reading. If TOU energy

measurement is not enabled, it displays real-time energy only.

The user divides the screen into two parts, the upper part indicates inline energy parameters, the lower part indicates the individual tenant energy parameters.

AccuRev 2020 Utility Software - Accuenergy Corporation

Season Setting: 12 Schedule Setting: 8 Tariff Setting: 4

Segment Setting: 14 Weekend Schedule: 5 Holiday Setting: 1

Current Tariff: 2 Fault Status Word 1: 0 Fault Status Word 2: 0

Monthly Billing Mode

End of Month

Assign Day: 1 Hour: 0

Enable TOU

Restore to Defaults

Weekend Day

Monday Tuesday Wednesday Thursday Friday

Saturday Sunday

Daylight Saving Time

DST Enable DST Format: Format 2

Format 1

DST Start

Jul 1 Day 1 Hour 32 Min Adjust Time 5 Minutes

DST Ending

Jul 1 Day 1 Hour 31 Min Adjust Time 1 Minutes

Format 2

DST Start

Sep 5th Sun at 23 : 46 Adjust Time 19 Minutes

DST Ending

Oct 1st Mon at 0 : 5 Adjust Time 20 Minutes

TOU Seasons

01-01-01	02-01-02	02-20-05	04-01-04	05-01-05	06-01-06	07-01-07
08-01-08	09-01-01	10-01-02	11-01-03	12-01-04	00:00:00	00:00:00

Holidays

01-01-01	01-02-02	01-03-03	00:00:00	00:00:00	00:00:00
00:00:00	00:00:00	00:00:00	00:00:00	00:00:00	00:00:00

TOU Settings @ 1 ERR: 3/4505 (0.07%)

Figure 4-9 Time of Use setting

TOU energy settings are in Figure 4-9.

Season: the maximum season number is 14.If the season number is smaller than the programmed season number, the energy meter only utilizes the first seasons (for instance, if the season number is 2, it only runs the first 2 seasons).

Schedule: the maximum schedule number is 8.If the schedule number is set as 3, the 4th to the 14th schedules will be unavailable.

Segment: the maximum segment number is 14.If the segment is set as 4, the 5th to the 14th segments will be unavailable. Only the first 4 segments are available.

Tariff: the maximum tariff number is 4.If tariff number in the schedule is larger than the set tariff number or equals 0, the energy in this schedule will be using tariff 1.

Weekend: setup the schedule number according to weekends.

Holiday: the maximum holiday number is 30.If it is set as 0, it indicates public holiday disabled. For instance, public holidays, such as January 1, December 25th, which users can set. Public holidays and their schedule number can be configured as different public holidays by using different schedule numbers.

Note: if the public holiday and weekend schedule number is set as 0, it means these public holidays are unavailable. If the weekend and public holidays are overlapped, the public holiday overrides the weekend setting, holiday has the higher priority.

Parameter Settings: changing tariff settings will do an auto check. If there is an error found, it will send out an alert and an error message status. In the error state all tariffs should follow tariff 1, until the status is corrected. Season and Schedule settings must be continuous, the starting time of the 2nd season is the ending time of the 1st season, the same rule applies to the rest.

Daylight saving time (DST): Daylight saving time can be enabled in one of two formats: The fixed date option, or a fixed day of one of the weeks in the month (also named as the non-fixed date option). If you choose a fixed date option, you set the format according to a fixed date, for the daylight saving time switch: the format month / day / hour / minute / adjust time (in minutes). If you choose non-fixed date option, DST will be implemented by which day of which week, whose setting format is month/which day (i. e. Tuesday)/which week (i.e. 1st week)/hour/minute/adjust time(in minutes).

By using the function, you can cause the instrument to automatically switch to and from daylight saving time. When the clock starts to run to daylight saving time, the meter will automatically adjust the clock to a time period in advance, while the clock is running to the end of daylight saving time, meter will automatically adjust the clock pushed back to a time period, as shown in Figure 4-10

The screenshot shows a software interface for configuring Daylight Saving Time (DST). It is divided into two sections: 'Format 1' and 'Format 2'. Each section has a 'DST Start' and a 'DST Ending' row. In 'Format 1', the start is set to July 1st at 1:32 AM with a 5-minute adjustment, and the end is set to July 1st at 1:31 AM with a 1-minute adjustment. In 'Format 2', the start is set to the 5th of September on a Sunday at 23:46 with a 19-minute adjustment, and the end is set to the 1st of October on a Monday at 0:05 with a 20-minute adjustment.

Format	DST Start	DST Ending
Format 1	Jul 1 Day 1 Hour 32 Min Adjust Time 5 Minutes	Jul 1 Day 1 Hour 31 Min Adjust Time 1 Minutes
Format 2	Sep 5th Sun at 23 : 46 Adjust Time 19 Minutes	Oct 1st Mon at 0 : 5 Adjust Time 20 Minutes

Figure 4-10 DST display

Ten-year Holiday setting

Users can preset holidays of the next decade via the meter software. The holiday format is month/day/year; holiday code; holiday schedule. After the format setup, click on "Make

Holiday Settings (10 year)", then a holiday table for the next decade will be generated.

Holiday Auto Switch: When Ten-year Holiday is enabled, if the current year of the meter falls into the Ten-year Holiday setting, it automatically loads the Ten year Holiday settings into the current TOU settings. If the current year of the meter does not fall into the Ten-year Holiday setting, it remains the current TOU settings.

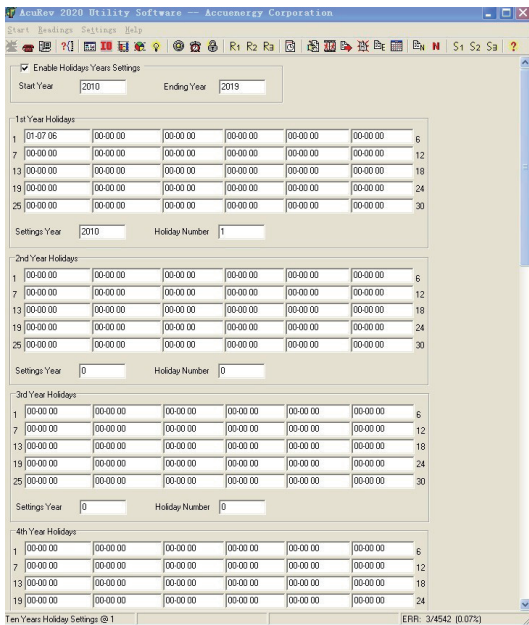

Figure 4-11 Holiday Settings

4.5 Sequence of Events(SOE)

AccuRev 2020 Utility Software — Accuenergy Corporation

Start Readings Settings Help

R1 R2 Ra

No.	Time Stamp	ms	DI 1	DI 2	DI 3	DI 4	DI 5	DI 6	DI 7	DI 8
1	2013-7-29 9:35:30	495	OFF	ON	OFF	OFF	OFF	OFF	OFF	OFF
2	2013-7-29 9:35:31	372	OFF	OFF	OFF	OFF	OFF	OFF	OFF	OFF
3	2013-7-29 9:35:32	142	OFF	ON	OFF	OFF	OFF	OFF	OFF	OFF
4	2013-7-29 9:35:33	502	OFF	OFF	OFF	OFF	OFF	OFF	OFF	OFF
5	2013-7-29 9:35:34	337	OFF	ON	OFF	OFF	OFF	OFF	OFF	OFF
6	2013-7-29 9:35:35	93	OFF	OFF	OFF	OFF	OFF	OFF	OFF	OFF
7	2013-7-29 9:35:42	148	OFF	OFF	OFF	OFF	OFF	OFF	ON	OFF
8	2013-7-29 9:35:42	148	OFF	OFF	OFF	OFF	OFF	OFF	ON	ON
9	2013-7-29 9:35:44	505	OFF	ON	OFF	OFF	OFF	OFF	ON	ON
10	2013-7-29 9:35:46	537	OFF	OFF	OFF	OFF	OFF	OFF	ON	ON
11	2013-7-29 9:35:49	770	OFF	OFF	OFF	OFF	OFF	OFF	OFF	ON
12	2013-7-29 9:35:49	770	OFF	OFF	OFF	OFF	OFF	OFF	OFF	OFF
13	2013-7-29 9:35:03	604	OFF	ON	OFF	OFF	OFF	OFF	OFF	OFF
14	2013-7-29 9:35:04	196	OFF	OFF	OFF	OFF	OFF	OFF	OFF	OFF
15	2013-7-29 9:35:25	527	OFF	OFF	OFF	OFF	OFF	OFF	ON	OFF
16	2013-7-29 9:35:25	527	OFF	OFF	OFF	OFF	OFF	OFF	ON	ON
17	2013-7-29 9:35:26	629	OFF	OFF	OFF	OFF	OFF	OFF	OFF	ON
18	2013-7-29 9:35:26	629	OFF	OFF	OFF	OFF	OFF	OFF	OFF	OFF
19	2013-7-29 9:35:28	490	OFF	ON	OFF	OFF	OFF	OFF	OFF	OFF
20	2013-7-29 9:35:29	330	OFF	OFF	OFF	OFF	OFF	OFF	OFF	OFF

Newest SOE Record No. 12

Clear SOE

Figure 4-12 SOE in software

When DI is used as remote signal detection, it will record SOE. SOE is when DI circuits detect the change of the signal voltage level, it records the channel, the event and the event's timestamp.

The SOE records DI1-DI8 input status change and its time, it allows up to 20 events. The newest event number can be displayed.

4.6 Over/Under Limit Alarming

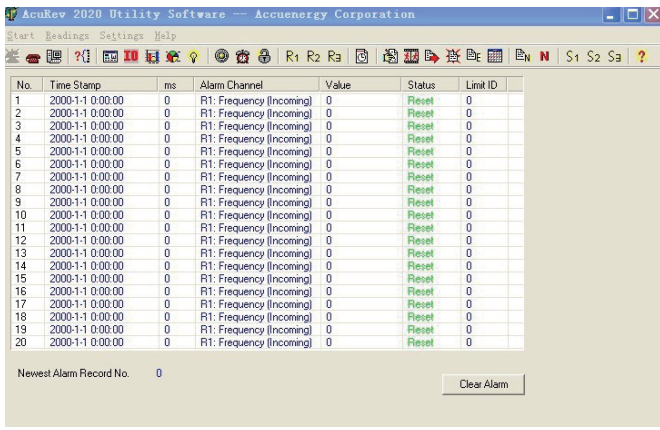

Figure 4-13 Alarming in software

Alarming records alarming timestamp, alarming parameter, over/under limit value, alarming status and alarming condition. Users can setup alarming conditions in "Alarm Setup". The maximum alarming record is 20.

Note: The alarming threshold value is not a real measured value, it is the percentage of real measured value over rated value. For instance, if the rated value is 1100, the displayed threshold is 40, then real value = rated value x percentage = 1100×40% = 440.

Please refer to Figure 4-11 for detailed setup.

Enable Alarm

Limit ID	Enable	Alarm Channel	Setting	Setpoint	Delay (ms)	Output	
#1	<input type="checkbox"/>	Real-Time Metering(Incoming)	Frequency	>	50	300	RD2
#2	<input type="checkbox"/>	Real-Time Metering(Incoming)	Frequency	>	0	0	None
#3	<input type="checkbox"/>	Real-Time Metering(Incoming)	Frequency	>	0	0	None
#4	<input type="checkbox"/>	Real-Time Metering(Incoming)	Frequency	>	0	0	None
#5	<input type="checkbox"/>	Real-Time Metering(Incoming)	Frequency	>	0	0	None
#6	<input type="checkbox"/>	Real-Time Metering(Incoming)	Frequency	>	0	0	None
#7	<input type="checkbox"/>	Real-Time Metering(Incoming)	Frequency	>	0	0	None
#8	<input type="checkbox"/>	Real-Time Metering(Incoming)	Frequency	>	0	0	None
#9	<input type="checkbox"/>	Real-Time Metering(Incoming)	Frequency	>	0	0	None
#10	<input type="checkbox"/>	Real-Time Metering(Incoming)	Frequency	>	0	0	None

Save Load Update Device

Figure 4-14 Alarming Setup

Set up alarming rule, including alarming parameter, alarming condition, alarming target, delay time (ms) and alarming output.

Energy and alarm switch can be set at the same time. Current rating and voltage rating are the load's current and voltage ratings. (Current rating relates to transformer type, such as CT-20 transformer current rating is 5A)

The maximum alarming condition can be set as 10.

Alarming parameters includes inline basic parameter, tenant basic parameter, inline demand and tenant demand.

Inline basic parameters: system real power; real power Pa; real power Pb; real power Pc.

Channel Basic parameters: system real power; real power Pa; real power Pb; real power Pc.

Inline demand: system real power; system real power demand prediction; system power demand Pa; power demand Pa prediction; system power demand Pb; system power demand Pb prediction; system power demand Pc; system power demand Pc prediction

Channel Demand: System Power; real power demand Pa; real power demand Pa prediction; real power demand Pb; real power demand Pb prediction; real power demand Pc; real power demand Pc prediction.

Condition: >(larger than); =(equal) ; <(smaller than).

Alarming setpoint: alarming setpoint is expressed by the percentage of rated value.

For instance: voltage rating is 220 V, transformer type CT-20, now it requires alarms when the 1st tenant's real power is larger than 3 kW. Since rated power is 1.1 kW, 3kW is 1.1kW 273%, then set alarming setpoint as 273.

Time Delay: 0-30000 ms

Output: No output; one of RO1-RO4.

4.7 System Event Log

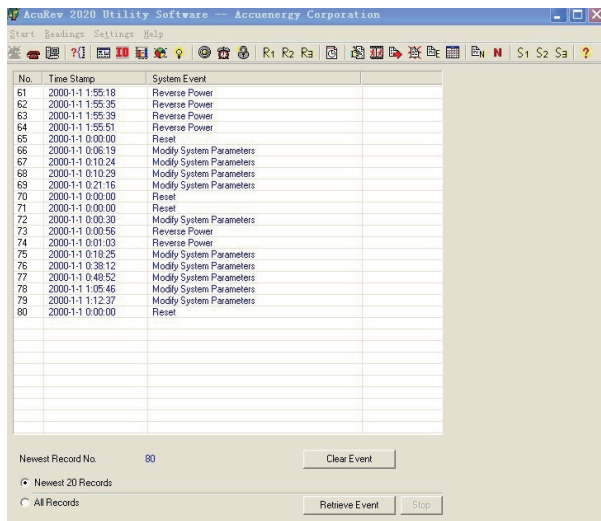

Figure 4-15 System Event Log

Logs system event date and type. Please refer to the 12 system events in 4.2. The max record number is 100. It can be chosen as "the newest 20 records" or "all records".

4.8 Trending Record

In order to have the user understand meter's history, the meter provides trending record function, which is logging a group of data with a preset time interval. AcuRev 2000 has 8 MB of memory, which is used for logging the historic trending. The meter has a system clock therefore, all of the trending records have a timestamp when they are created.

Trending Record Setup

AcuRev 2000 has 3 trending logs, each log can be programmed individually. Different contents can be added into 3 logs. Each log slot can be added up to 117 parameters. The memory size of the 3 logs can also be configured, however, the total sector number of the 3 logs cannot be over 100 (each sector has 64 kB). Trending log #1 configuration page can be found in Figure 4-13.

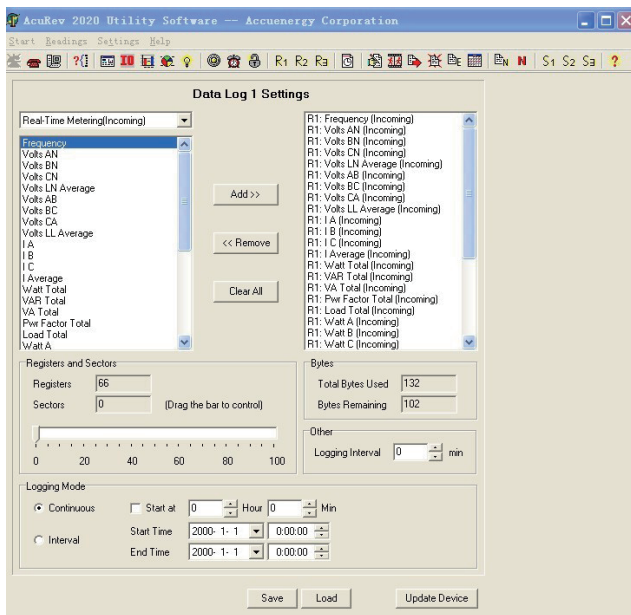

Figure 4-16 Trending Log #1 Configuration

Different contents can be added into 3 logs to meet users' requirements. For example, log #1 can be configured as basic parameter measurement (such as Power), log #2 can be configured as energy measurement, log #3 can be configured as demand measurement. log # can be choose from 8 categories:

1. Real-Time Metering(Incoming),
2. Real-Time Metering(User),
3. Demand(Incoming),
4. Demand(User),
5. Energy(Real-Time Incoming),
6. Energy(Current Month TOU-Incoming),
7. Energy(Prior Month TOU-Incoming),
8. Energy(Real Time-User)

Inline real-time parameters:

Users can set different parameters from the 8 categories. Generally, one trending record needs the following settings:

1)8 categories;

2)Choose Parameters:

- a. Select the interested parameters from the left column.
- b. Press "Add" button, the selected parameters will be added to the right column.
- c. If a parameter needs to be removed, select the parameter in the right column, click "Remove" to deselect it.

3)Set logging interval:

The logging interval can be set as any integer between 0-1440.It is how often a record will be logged. When it is set as 0, the logging feature is disabled.

4) Log sector size setup:

The log sector size can be selected between 0 and 100. Make sure the total sector number of the 3 logs does not exceed 100.

5) Select the corresponding trend recording mode.

Note:

- If logging Timer mode is selected as Mode 2, when the memory is full, no more records will be logged. If you choose to Mode 1 or Mode 3, when the memory is full, the meter keeps logging, the earliest records will be overwritten by the latest record.
- When overwriting happens, the earliest whole sector will be erased (64 kB data will be erased). It is recommended that users retrieve all the data and save them before the memory is full in order to avoid data loss.
- There are two regions displaying register number, total used bytes and remaining bytes. These values are automatically calculated by the software according to users' selected parameters. The total bytes available is 234.

Retrieve Record

There are two methods to retrieve records: manual retrieve and automatic retrieve. The retrieve page can be found in Figure 4-14.

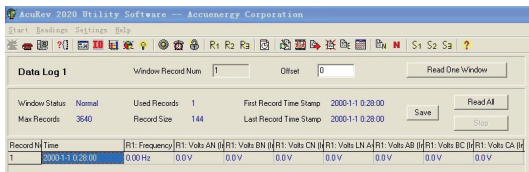

Figure 4-17 Log #1 Record Retrieve

In manual retrieve mode, users can adjust Offset and Window Record Number. Offset is the

deviation number from the first record. Window Record Number is 246 / Record Size, users can retrieve no larger than this number of records by pressing "Read One Window" button.

In automatic retrieve mode, the software retrieves all the Used Records in the memory automatically. Users just press "Read All" button.

4.9 Seal Function

The display module with seal, which has sealed key control, is different with one without seal. When the seal is in opened status, functions are same like normal meters. But when the seal is in sealed status, some functions of meters, which include parameters blocked by seal and optional parameters, will be blocked. These parameters can still be accessible by keys and communication way if they can be accessed before, but in sealed status, these parameters cannot be modified by keys or communication way any more.

Addresses about seal function are 8AFH and 8B0FH.

Address 8AFH is about parameters blocked by seal, which can be configured by users. These setting will be valid only when seal is in sealed status.

Address 8B0H is about if seal function is valid. When the display module is normal one, not connected display module, or the seal module is in invalid sealed status, this address will show seal is open. When the seal is valid, this address will show sealed status and corresponding parameters will be blocked.

Address	Parameter	Description
8AFH	Sealed Nonstandard Parameters Selection	Bit0: RS485 communication parameters and infrared communication parameters Bit1: network parameters Bit2: Clear Meter Run Time Bit3: DI pulse counting Bit4: TOU Bit5: RO 1: valid of corresponding selection 0: invalid of corresponding selection
8B0H	Seals status	0x0A: Seal sealed; Other: Seal opened.

Parameters blocked by seal

As long as seal is in sealed status, parameters below must be blocked, no matter what value of address 8AFH.

System parameters setting:

Address	Parameter	Keys	Communication
806H	Energy constant pulse	√	√
807H	Energy pulse width	√	√
808H	DO1 output energy pulse channel settings	√	√
809H	DO2 output energy pulse channel settings	√	√
80AH	Demand calculating mode	√	√
80BH	Demand period	√	√
80CH	Secondary period of Demand	√	√
80DH	DI Synchronization Source	√	√

80EH	DI Triggering Condition	√	√
835H	Reactive Power	√	√
836H	VAR/PF Convention	√	√
837H-Bit0	Clear energy data	√	√
837H-Bit1	Clear demand data	√	√
842H	user01 Mappings	√	√
846H	user02 Mappings	√	√
84AH	user03 Mappings	√	√
84EH	user04 Mappings	√	√
852H	user05 Mappings	√	√
856H	user06 Mappings	√	√
85AH	user07 Mappings	√	√
85EH	user08 Mappings	√	√
862H	user09 Mappings	√	√
866H	user10 Mappings	√	√
86AH	user11 Mappings	√	√
86EH	user12 Mappings	√	√
872H	user13 Mappings	√	√
876H	user14 Mappings	√	√
87AH	user15 Mappings	√	√
87EH	user16 Mappings	√	√
882H	user17 Mappings	√	√
886H	user18 Mappings	√	√
887H	Load voltage rating setting	--	√
888H	Connection mode of three-phase user	√	√
889H	Channel 1 CT Specifications	√	√
88AH	Channel 2 CT Specifications	√	√
88BH	Channel 3 CT Specifications	√	√
88CH	Channel 4 CT Specifications	√	√

88DH	Channel 5 CT Specifications	√	√
88EH	Channel 6 CT Specifications	√	√
88FH	Channel 7 CT Specifications	√	√
890H	Channel 8 CT Specifications	√	√
891H	Channel 9 CT Specifications	√	√
892H	Channel 10 CT Specifications	√	√
893H	Channel 11 CT Specifications	√	√
894H	Channel 12 CT Specifications	√	√
895H	Channel 13 CT Specifications	√	√
896H	Channel 14 CT Specifications	√	√
897H	Channel 15 CT Specifications	√	√
898H	Channel 16 CT Specifications	√	√
899H	Channel 17 CT Specifications	√	√
89AH	Channel 18 CT Specifications	√	√
8ADH	Restore the default parameters (User name and mappings, and CT wiring specifications)	√	√
8AFH	Sealed Nonstandard Parameters Selection	√	√

Note: "√" means these addresses will be blocked for keys and communication, and "--" means this function is unavailable.

Energy:

Address	Parameter	Keys	Communication
2500H-2501H	Epin-A inline Phase A real time energy	--	√
2502H-2503H	Epin-B inline Phase B real time energy	--	√
2504H-2505H	Epin-C inline Phase C real time energy	--	√
2506H-2507H	Epin-S inline system real time energy	--	√
2508H-2509H	Channel 1 real-time energy	--	√

250AH-250BH	Channel 2 real-time energy	--	√
250CH-250DH	Channel 3 real-time energy	--	√
250EH-250FH	Channel 4 real-time energy	--	√
2510H-2511H	Channel 5 real-time energy	--	√
2512H-2513H	Channel 6 real-time energy	--	√
2514H-2515H	Channel 7 real-time energy	--	√
2516H-2517H	Channel 8 real-time energy	--	√
2518H-2519H	Channel 9 real-time energy	--	√
251AH-251BH	Channel 10 real-time energy	--	√
251CH-251DH	Channel 11 real-time energy	--	√
251EH-251FH	Channel 12 real-time energy	--	√
2520H-2521H	Channel 13 real-time energy	--	√
2522H-2523H	Channel 14 real-time energy	--	√
2524H-2525H	Channel 15 real-time energy	--	√
2526H-2527H	Channel 16 real-time energy	--	√
2528H-2529H	Channel 17 real-time energy	--	√
252AH-252BH	Channel 18 real-time energy	--	√
252CH-252DH	Channel 1 3-phase 4-line / single-phase 3-line real-time system active power energy	--	√
252EH-252FH	Channel 2 3-phase 4-line / single-phase 3-line real-time system active power energy	--	√
2530H-2531H	Channel 3 3-phase 4-line / single-phase 3-line real-time system active power energy	--	√
2532H-2533H	Channel 4 3-phase 4-line / single-phase 3-line real-time system active power energy	--	√
2534H-2535H	Channel 5 3-phase 4-line / single-phase 3-line real-time system active power energy	--	√
2536H-2537H	Channel 6 3-phase 4-line / single-phase 3-line real-time system active power energy	--	√
2B00H-2B01H	Eqin-A inline Phase A Reactive Power Energy	--	√

2B02H-2B03H	Eqin-B inline Phase B Reactive Power Energy	--	√
2B04H-2B05H	Eqin-C inline Phase C Reactive Power Energy	--	√
2B06H-2B07H	Eqin-S inline system Reactive Energy	--	√
2B08H-2B2BH	Tenant 1-18 real-time Reactive Power Energy	--	√
2B2CH-2B2DH	Tenant 1 real-time system Reactive Power Energy	--	√
2B2EH-2B37H	Tenant 2-6 Reactive Power Energy data	--	√
2B38H-2B39H	Eqin-A inline Phase A Apparent Energy	--	√
2B3AH-2B3BH	Esin-B inline Phase B Apparent Energy	--	√
2B3CH-2B3DH	Esin-C inline Phase C Apparent Energy	--	√
2B3EH-2B3FH	Esin-S inline system Apparent Energy	--	√
2B40H-2B63H	Tenant 1-18 real-time Apparent Energy	--	√
2B64H-2B65H	Tenant 1 real-time system Apparent Energy	--	√
2B66H-2B6FH	Tenant 2-6 Apparent Energy data	--	√

Sealed Nonstandard Parameters:

1) When bit 0 of address 8AFH is valid, parameters about RS communication should be blocked.

Address	Parameter	Keys	Communication
800H	Meter Address	√	√
801H	Channel 1 485 communication Modbus parity bit setting	√	√
802H	Infrared communication parity bit setting	√	√
803H	Channel 1 485 communication Modbus baud rate	√	√
804H	Infrared communication baud rate	√	√
839H-83EH	645 Address	√	√

2) When bit 1 of address 8AFH is valid, parameters about Network parameters should be blocked.

Address	Parameter	Keys	Communication
FFH	Reset and restore the default values	√	√
102H	DHCP setting	√	√
103H	IP address 1st byte (high) IP address 2nd byte (low)	√	√
104H	IP address 3rd byte (high) IP address 4th byte (low)	√	√
105H	Submask 1st byte (high) Submask 2nd byte (low)	√	√
106H	Submask 3rd byte (high) Submask 4th byte (low)	√	√
107H	Gateway 1st byte (high) Gateway 2nd byte (low)	√	√
108H	Gateway 3rd byte (high) Gateway 4th byte (low)	√	√
109H	DNS1 1st byte (high) DNS1 2nd byte (low)	√	√
10aH	DNS1 3rd byte (high) DNS1 4th byte (low)	√	√
10bH	DNS2 1st byte (high) DNS2 2nd byte (low)	√	√
10cH	DNS2 3rd byte (high) DNS2 4th byte (low)	√	√
10dH	Modbus Tcp/Ip port	√	√
10eH	Http port	√	√

3) When bit 2 of address 8AFH is valid, parameters below should be blocked.

Address	Parameter	Keys	Communication
837H-Bit6	Battery run time clear	√	√
837H-Bit5	Meter run time clear	√	√

4) When bit 3 of address 8AFH is valid, parameters below should be blocked.

Address	Parameter	Keys	Communication
80FH	DI Working Mode	√	√
810H-817H	DI1-8 Pulse Constant for each channel	√	√
818H-81FH	DI Category, x8	√	√
820H-827H	DI Unit, x8	√	√
838H	DI Pulse Counter clear	√	√

5) When bit 4 of address 8AFH is valid, parameters below should be blocked.

Address	Parameter	Keys	Communication
1054H	Year	√	√
1055H	Month	√	√
1056H	Day	√	√
1057H	Hour	√	√
1058H	Minute	√	√
1059H	Second	√	√
105AH	Week	√	√

Note: Standard time is valid within ± 5 minutes, it will be invalid if not in this range.

Address	Parameter	Keys	Communication
8AEH	Ten years download setting enable	--	√
TOU			
1093H-109EH	Basis parameter of TOU	--	√

10B0H-10D9H		--	√
10DAH-1229H		--	√
122AH-1283H		--	√
Current TOU energy			
2600H-2627H	In-line Current TOU energy	--	√
2628H-2717H	Each channel Current TOU energy	--	√
DST setting			
4000H	DST enable	--	√
4001H	DST format	--	√
4002H	DST Start Mon	--	√
4003H	DST Start Day	--	√
4004H	DST Start Hour	--	√
4005H	DST Start Min	--	√
4006H	DST Start Adjust time (Unit: Min)	--	√
4007H	DST Ending Mon	--	√
4008H	DST Ending Day	--	√
4009H	DST Ending Hour	--	√
400AH	DST Ending Min	--	√
400BH	DST Ending Adjust time (Unit: Min)	--	√
400CH	DST Start Mon	--	√
400DH	DST Start week	--	√
400EH	DST Start First few weeks	--	√
400FH	DST Start Hour	--	√
4010H	DST Start Min	--	√
4011H	DST Start Adjust time (Unit: Min)	--	√
4012H	DST Ending Mon	--	√
4013H	DST Ending Week	--	√
4014H	DST Ending First few weeks	--	√
4015H	DST Ending Hour	--	√
4016H	DST Ending Min	--	√

4017H	DST Ending Adjust time (Unit: Min)	--	√
Ten years holiday setting			
4100H	Holiday setting enable	--	√
4101H	Start year holiday setting	--	√
4102H	End year holiday setting	--	√
The 1st year holiday setting			
4103H-415EH	Holiday Parameter setting	--	√
The 2nd year Holiday setting			
415FH-41BA	Holiday Parameter setting	--	√
The 3rd year Holiday setting			
41BBH-4216H	Holiday Parameter setting	--	√
The 4nd year Holiday setting			
4217H-4272H	Holiday Parameter setting	--	√
The 5nd year Holiday setting			
4273H-42CEH	Holiday Parameter setting	--	√
The 6nd year Holiday setting			
42CFH-432AH	Holiday Parameter setting	--	√
The 7nd year Holiday setting			
432BH-4386H	Holiday Parameter setting	--	√
The 8nd year Holiday setting			
4387H-43E2H	Holiday Parameter setting	--	√
The 9nd year Holiday setting			
43E3H-443EH	Holiday Parameter setting	--	√
The 10nd year Holiday setting			
443FH-449AH	Holiday Parameter setting	--	√

6) When bit 5 of address 8AFH is valid, parameters about RO should be blocked.

Address	Parameter	Keys	Communication
828H	Relay Output Working Mode	√	√

829H	Relay Control Mode	√	√
82AH	Relay Control Momentary Time	√	√
82BH	Alarming Feature	√	√
82CH	1-10 Alarming Channel	--	√
82DH	Each event alarm is sent to RO feature bit. 2 bytes represent 16 events sent to RO feature	--	√
82EH	RO alarming, each one of the first 8 events corresponds to RO settings	--	√
82FH	Same as above, the last 8 events	--	√
830H	RO alarming time delay, not applicable to over/under limit alarming	--	√

4.10 Device Information

The screenshot displays the AcuRev 2020 Utility Software interface. The title bar reads "AcuRev 2020 Utility Software -- Accuenergy Corporation". The menu bar includes "Start", "Readings", "Settings", and "Help". The toolbar contains various icons for navigation and actions, including "R1", "R2", and "Ra".

The main content area is divided into several sections:

- Device:**
 - Device Type: HC02 (AcuRev 2020)
 - Hardware Version: 2.03
 - Software Version: 2.05
 - Release Date: 20130725
 - Serial Number: (empty)
- Display Module:**
 - Device Type: SA31
 - Hardware Version: 1.03
 - Software Version: 2.03
 - Release Date: 20130715
- Net Module:**
 - Device Type: ANEM
 - Hardware Version: 1.01
 - Software Version: 1.01
 - Release Date: 20130109

Below the module information, there are controls for run-time and clock settings:

- Device Run-Time:** 32.75 Hours. A button labeled "Reset Device Run-Time" is present.
- Battery Run-Time:** 0 Hours. A button labeled "Reset Battery Run-Time" is present.
- Device Clock:** 2000-1-1 0:30:14 SAT. A button labeled "Set Device Clock" is present.
- Below the clock, there are radio buttons for time synchronization:
 - Use PC Time
 - 2000- 1- 1 [dropdown] 0:00:00 [spinners]

Figure 4-18 Device Information

Chapter 5 Communication

5.1 Modbus Protocol Introduction

5.2 Modbus Communication Format

5.3 Ethernet communication

5.4 Application Details and Parameter Address Table

AcuRev 2000 supports Modbus communication protocols. The infrared port supports field meter reading; The meter supports 10/100 M Ethernet port, protocols are Modbus TCP, SMTP, HTTP, SNMP, SNTP

5.1 Modbus Protocol Introduction

1. Transmission mode

The mode of transmission defines the data structure within a frame and the rules used to transmit data.

▲ Coding System	8 bit
▲ Start bit	1 bit
▲ Data bits	8 bit
▲ Parity	No parity / odd parity / even parity
▲ Stop bit	1 bit or 2 bit
▲ Error checking	CRC

2. Frame

When data frame reaches the terminal unit, it goes through the unit via a special "port", the unit removes the data frame's header, reads the data, if there is no error, then it implements the data's task. Afterwards, the unit puts its own data with the acquired header, and sends back the frame to the sender. The response data frame contains: Address, Function, Data and CRC Check. Any error will cause a failure to respond.

Frame Format

Address	Function	Data	Check
8-Bits	8-Bits	Nx8-Bits	16-Bits

Table 5-1 Data Frame Format

Address Field

The address field is at the start of the frame. It is composed of 1 byte (8 bits), its decimal value range is 0-247.

A master addresses a slave by placing the slave address in the address field of the message. When the slave sends its response, it places its own address in this address field of the response to let the master know which slave is responding.

Function Field

When a message is sent from a master to a slave device the function code field tells the slave what kind of action to perform.

Code	Meaning	Action
01	Read DO status	Obtain Digital (Relay) Output current status (ON/OFF)
02	Read DI status	Obtain Digital Input current status (ON/OFF)
03	Read Data	Obtain current binary value from one or more registers
05	Control DO	Control Digital (Relay) Output(ON/OFF)
16	Preset multiple registers	Place specific value into a series of consecutive multiple-registers

Table 5-2 Function Code

Data Field

Data field contains the data that terminals need to complete the request and the data that terminals respond to the request. This data may be a numerical value, address or setting. For example, Function Code tells the terminal to read one register, Data Field needs to specify reading from which register and how many registers to read.

Error Check Field

The field allows the error check by master and slave devices. Due to electrical noise and other interferences, a group of data may be changed while transmitting from one location to the other. Error Check ensures master or slave devices do not respond to the distorted data during the transmission, which enhances the system security and efficiency. Error Check uses 16-bit Cyclic Redundancy Check (CRC 16).

3. CRC Check

Every message includes an error checking field which is based on the Cyclical Redundancy Check (CRC) method. The CRC field checks the contents of the entire message. It is applied regardless of any parity check method used for the individual characters of the message. The CRC field is two bytes long, containing a 16-bit binary value. The CRC value is calculated by the transmitting device, and is appended to the message.

The receiving device recalculates the CRC value during reception of the message, and compares the calculated value to the actual value it received in the CRC field.

An error will be reported if the two values are not equal. CRC calculation is first started by preloading the whole 16-bit register to 1's. The process begins by applying successive 8-bit bytes of the message to the current contents of the register. Only the eight bits of data in each character are used for generating the CRC. Start and stop bits, and the parity bit, do not apply to the CRC.

When generating the CRC, each 8-bit character is exclusive ORed with the register

contents. The result is shifted towards the least significant bit (LSB), with a zero filled into the most significant bit (MSB) position. The LSB is extracted and examined, if the LSB equals to 1, the register is exclusive ORed with a preset, fixed value; if the LSB equals to 0, no action will be taken. This process is repeated until eight shifts have been performed. After the last (eighth) shift, the next 8-bit byte is exclusive ORed with the register's current value, and the process repeats for eight more shifts as described above. The final contents of the register, after all the bytes of the message have been applied, is the CRC value. When the CRC is appended to the message, the low-order byte is appended first, followed by the high-order byte.

5.2 Modbus Communication Format

Addr	Fun	Data start reg hi	Data start reg lo	Data #of regs hi	Data #of regs lo	CRC16 Hi	CRC16 Lo
06H	03H	00H	00H	00H	21H	84H	65H

Figure 5-3 Protocol Illustration

Addr: Slave device address

Fun: Function Code

Data start reg hi: Start register address, high byte

Data start reg lo: Start register address, low byte

Data #of reg hi: Number of registers, high byte

Data #of reg lo: Number of registers, low byte

CRC16 Hi: CRC high byte

CRC16 Lo: CRC low byte

1. Read Relay Output status(Function Code 01)

Query

The master device sends query frame to the slave device. Function Code 01 allows users to acquire the relay output status (1=ON, 0=OFF) of the slave device with the specified address. On top of slave device address and function code, query frame must contain the relay register starting address and the number of registers to be read.

Table 5-4 depicts reading Relay 1 and Relay 2 status of the slave device with the address of 17.

Addr	Fun	Relay start reg hi	Relay start reg lo	Relay #of regs hi	Relay #of regs lo	CRC16 Hi	CRC16 Lo
11H	01H	00H	00H	00H	02H	BFH	5BH

Table 5-4 Query frame of reading Relay Output status

Response

The slave device answers the master device's query. The response frame contains slave device address, function code, data quantity and CRC check. Each relay utilizes one bit(1 = ON , 0 = OFF). Table 5-5 depicts the response frame.

Addr	Fun	Byte count	Data	CRC16 hi	CRC16 lo
11H	01H	01H	02H	D4H	89H

Data Bytes

7	6	5	4	3	2	1	0
0	0	0	0	0	0	1	0

MSB

LSB

(Relay 1 = OFF , Relay 2=ON)

Table 5-5 Response frame of reading Relay Output status

2. Read the status of DI (Function Code 02)

Query

On top of slave device address and function code, query frame must contain the digital input register starting address and the number of registers to be read. DI register address starts from 0000H(DI1=0000H, DI2=0001H, DI3=0002H, DI4=0003H).

Table 5-6 depicts of reading DI1 to DI4 status of the slave device with the address of 17.

Addr	Fun	DI start addr hi	DI start addr lo	DI num hi	DI num lo	CRC16 hi	CRC16 lo
11H	02H	00H	00H	00H	04H	7BH	59H

Table 5-6 Query frame of reading DI status

Response

The slave device answers the master device's query. The response frame contains slave device address, function code, data quantity and CRC check. Each DI utilizes one bit (1 = ON, 0 = OFF). Table 5-7 depicts the response frame.

Addr	Fun	Byte count	Data0	CRC16 hi	CRC16 lo
11H	02H	01H	03H	E5H	49H

Data Bytes

0	0	0	0	DI4	DI3	DI2	DI1
0	0	0	0	0	0	1	1

MSB

LSB

Table 5-7 Response frame of reading DI status

3. Read Data (Function Code 03)

Query

This function allows the master to obtain the measurement results from the meter.

Table 5-8 depicts reading slave device (address 17) Inline A real-time energy, Inline B real-time energy, , Inline C real-time energy (these parameters are dword data type, each parameter uses 2 addresses, each address uses 2 bytes). AcuRev 2000 Inline A real-time energy address is 2500H, 2501H; Inline B real-time energy address is 2502H, 2503H; Inline C real-time energy is 2504H, 2505H.

Addr	Fun	Data start addr hi	Data start Addr lo	Data #of regs hi	Data #of regs lo	CRC16 hi	CRC16 lo
11H	03H	25H	00H	00H	06H	CCH	54H

Table 5-8 Query of Inline A real-time energy, Inline B real-time energy, Inline C real-time energy

Response

Response frame contains slave device address, function code, data quantity and CRC check.

Table 5-9 depicts Inline A real-time energy=0000000BH(1.1kWh), Inline B real-time energy=0000000CH(1.2kWh), Inline C real-time energy=0000000D(1.3kWh).

Addr	Fun	Byte count	Data1 hi	Data1 Lo	Data 2 hi	Data2 lo	Data3 hi	Data3 lo	Data4 hi	Data4 lo
11H	03H	0CH	00H	00H	00H	0BH	00H	00H	00H	0CH

Data5 hi	Data5 Lo	Data 6 hi	Data6 lo	CRC16 hi	CRC16 lo
00H	00H	00H	0DH	21H	88H

Table 5-9 Response of Inline A real-time energy, Inline B real-time energy, Inline C real-time energy

4. Control Relay Output (Function Code 05)

Query

This query frame forces the relay status to ON or OFF. Data FF00H sets the relay as ON, and data 0000H sets the relay as OFF. The relay will not be influenced by any other data input

The following is to query slave device 17 to set relay status as ON.

Addr	Fun	DO addr hi	DO addr Lo	Value Hi	Value lo	CRC16 hi	CRC16 lo
11H	05H	00H	00H	FFH	00H	8EH	AAH

Table 5-10 Control relay status query frame

Response

The correct response to this request is to send back the received data after the relay status is changed.

Addr	Fun	Do addr Hi	Do addr Lo	Value Hi	Value Lo	CRC16 Hi	CRC16 Lo
11H	05H	00H	00H	FFH	00H	8EH	AAH

Table 5-11 Control relay status response frame

5. Preset/Reset Multi-Register (Function Code 16)

Query

Function Code 16(10H Hex) allows the user to modify the contents of multiple registers. The example below is a request to preset device address of 17's channel #1's real-time energy as 12345.6 kWh. AcuRev 2000 energy is raw data multiplied by 0.1 kWh, therefore, the value written into the register should be 123456, hex format is 01E240H. Channel #1's real-time energy address is 2508H and 2509H, 32 bit, total 4 Bytes.

Addr	Fun	Data start reg hi	Data start reg lo	Data #of reg hi	Data #of reg lo	Byte Count
11H	10H	25H	08H	00H	02H	04H

Value hi	Value Lo	Value hi	Value lo	CRC hi	CRC lo
00H	01H	E2H	40H	18H	C8H

Table 5-12 Preset tenant #1's real-time energy

Response

The correct response is to send back address, function code, data starting address, data bytes, CRC check after the value is changed.

Addr	Fun	Data start reg hi	Data start reg lo	Data #of reg hi	Data #of Reg lo	CRC16 hi	CRC16 lo
11H	10H	25H	08H	00H	02H	C9H	96H

Table 5-13 Preset Multi-register response frame

5.3 Ethernet communication

5.3.1 Introduction to Ethernet

Ethernet was originally developed by Xerox and then developed further by Xerox, DEC, and Intel. Ethernet uses a Carrier Sense Multiple Access with Collision Detection (CSMA/CD) protocol, and provides transmission speeds up to 10 Mbps.

Now Ethernet stands for LAN with CSMA/CD protocol.

Ethernet is the most current communication standard in LAN. This standard defines the used type of cable and the method of Signal processing in LAN.

5.3.2 Function Description of Ethernet module

Please read appendix of technical data and specifications of Ethernet module before using.

- * The Ethernet module supports Modbus-TCP protocol. It is used as a server, the default value of the protocol port is 502, and the user defined range of the protocol port is 2000~5999. The device address is the same as the meter.
- * The Ethernet module supports SMTP protocol. It has an email function and supports “Send mail for timing” mode and “Send mail for event” mode.
- * The Ethernet module supports HTTP protocol. It is used as an HTTP server, the default value of the protocol port is 80, and the scope of the protocol port is 6000~9999.
- * The Ethernet module supports SNMP protocol. It is used as a SNMP agent, providing management to MIB library, so you can get data from the meter.
- * The Ethernet module supports SNTP protocol. It can get update time to Coordinated Universal Time (UTC).

5.3.3 Definition of RJ45 Interface

The Ethernet module uses a standard RJ45 connector to access the Ethernet network. The mechanical and electrical characteristics of the connectors comply with the requirements of IEC 603-7.

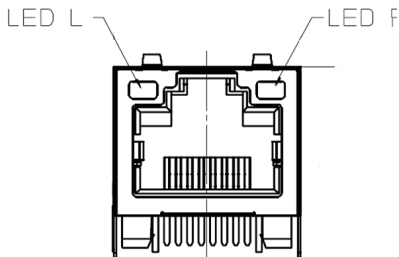

Figure 5-1

Script	ID	Content
1	TX+	Tranceive Data+
2	TX-	Tranceive Data-
3	RX+	Receive Data+
4	n/c	Not connected
5	n/c	Not connected
6	RX-	Receive Data-
7	n/c	Not connected
8	n/c	Not connected

Table 5-14

LED_L (yellow): displays speed status. LED on indicates 100Mbps, while LED off indicates 10Mbps.

LED_R (green): displays link and activity status combined. LED on indicates link status, while flashing LED indicates activity status.

5.3.4 Cable

Shielded twisted-pair cable (standard 568A or standard 568B) is usually recommended as reference to the EIA/TIA standard.

5.3.5 Connection Method

1. Direct Connect

The Ethernet module uses cross line (standard 568A) to connect to computers. The module supports Modbus-TCP, SNMP and HTTP functions for a direct connection.

2. Indirect Connect

The Ethernet module uses straight line (standard 568B) to access the Ethernet through a router or hub.

5.3.6 Initializing Ethernet Module

AXM-NET Module's default settings are as follows:

IP Address (192.168.1.254);

Subnet Mask (255.255.255.0);

Gateway (192.168.1.1);

This information can be found by using the keys on the meter front. The following process shows how to configure Ethernet module settings by using the front panel:

1. Pressing “◀” key and “▶” key simultaneously on the meter will go to the menu selecting mode. Cursor “E” flashes in this mode.

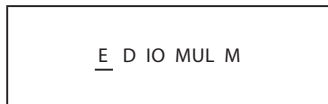

Figure 5-2

2. Press “▲” key or “▼” key to move the cursor to “NET”. Press “OK” key to go to the Ethernet module setting mode. Access Code page is the first page of “NET” mode. Press “OK” key to go to the Ethernet parameter setting page.

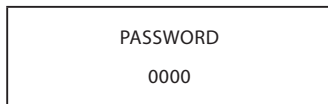

Figure 5-2

3. Set configuration mode in the first setting page. “AUTO” means that users configure module settings with DHCP protocol while “MANU” means that users configure module settings with manual setting. Press “OK” key, to go to the setting state. Press “▲” key or “▼” key to select configuration mode, press “OK” key to accept. Press the “▲” key again to go to the second setting page for IP Address.

Note: If you select the “AUTO” mode, please go to step 11 directly and reset module. Wait until the reset is finished and find the new IP address in the following step.

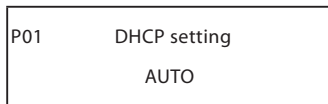

Figure 5-3

4. Set IP Address in the second setting page, such as 192.168.1.21 as shown below. Press the "OK" key to go to the IP setting page. The cursor starts at the first digit. After setting the IP address, press the "OK" key to accept. Press the "▲" key again to go to the third setting page for Subnet Mask.

P02	IP Address
	192.168.001.21

Figure 5-4

5. Set Subnet Mask in the third setting page, such as 255.255.255.0. Press the "OK" key to go to the setting page. The cursor starts at the first digit. After setting the Subnet Mask, press the "OK" key to accept. Press the "▲" key again to go to the fourth setting page for Gateway.

P03	Submask
	255.255.255.000

Figure 5-5

6. Set Gateway in the fourth setting page, such as 192.168.1.1. Press the "OK" key to go to the setting page. The cursor starts at the first digit. After setting the Gateway, press the "OK" key to accept. Press the "▲" key to go to the fifth setting page for DNS Primary Server.

P04	Gateway
	192.168.001.000

Figure 5-5

7. Set DNS Primary Server in the fifth setting page, such as 202.106.0.20. Press the "OK" key

to go to the setting page. The cursor starts at the first digit. After setting the DNS Primary Server, press the “OK” key to accept. Press the “▲” key to go to the sixth setting page for DNS Secondary Server.

Note: the DNS parameters must be set correctly to use the SMTP functions.

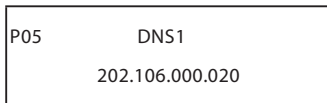

Figure 5-6

8. Set DNS Secondary Server in the sixth setting page, such as 202.106.196.115. Press the “OK” key to go to the setting page. The cursor starts at the first digit. After setting the DNS Secondary Server, press the “OK” key to accept. Press the “▲” key to go to the seventh setting page for the Modbus-TCP port.

Note: the DNS parameters must be set correctly in order to use the SMTP functions.

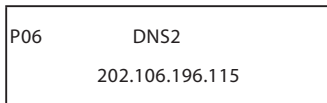

Figure 5-7

9. Set Modbus-TCP port in the seventh setting page, such as 502. Press the “OK” key to go to the setting page. The cursor starts at the first digit. After setting the Modbus-TCP port, press the “OK” key to accept. Press the “▲” key to go to the eighth setting page for the HTTP port. The Modbus-TCP port’s default value is 502, and the user defined range of port is 2000~5999. If the set port is not in the correct range, the set port will return to the default value.

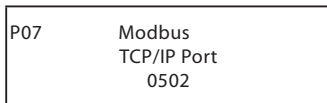

Figure 5-8

10. Set HTTP port in the eighth setting page, such as 80. Press the "OK" key to go to the setting page. The cursor starts at the first digit. After setting the HTTP port, press the "OK" key to accept. Press the "▲" key to go to the ninth setting page for the reset mode. The HTTP port's default value is 80, and the user defined range of port is 6000~9999. If the set port is not in the correct range, the set port will return to the default value.



Figure 5-9

11. Set resetting mode in the ninth setting page. Select "RESET" to reset the module. Selecting "NO" will not reset the module. Selecting "DEFAULT" will load the module with default settings and reset module. Press the "OK" key to go to the setting page. Press "▲" key or "▼" key to select configuration mode, press the "OK" key to accept.

Note: When configuring Ethernet module settings completely, users must select "RESET" to restart module and new settings will take effect.

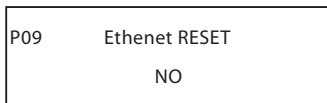

Figure 5-9

12. The password of AXM-NET module can be reset by selecting "RESET". The password then becomes "12345678". Selecting "NO" means no change. Press "OK" key to accept.

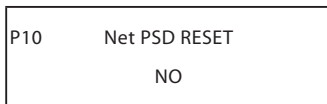

Figure 5-10

13. After configuring AXM-Net settings completely, press "►" key and "◀" key simultaneously to return to menu selecting mode.

5.3.7 Searching IP Address of Ethernet Module

The utility software of AcuRev 2000 series meter supports a meter search function. Users can use this function to obtain IP and MAC addresses of Ethernet Modules.

Operation steps:

- 1) Click "Start" menu of utility software.
- 2) Click "Search Device" menu.

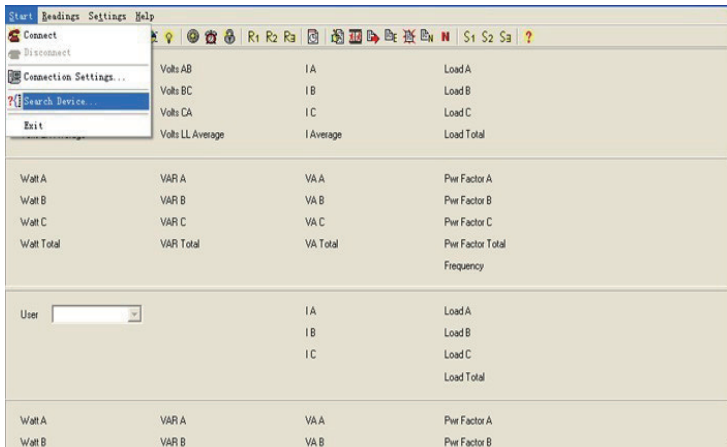

Figure 5-11

3) Utility software pop-ups “Search Device(s)” window, and the window displays IP address and MAC address of module.

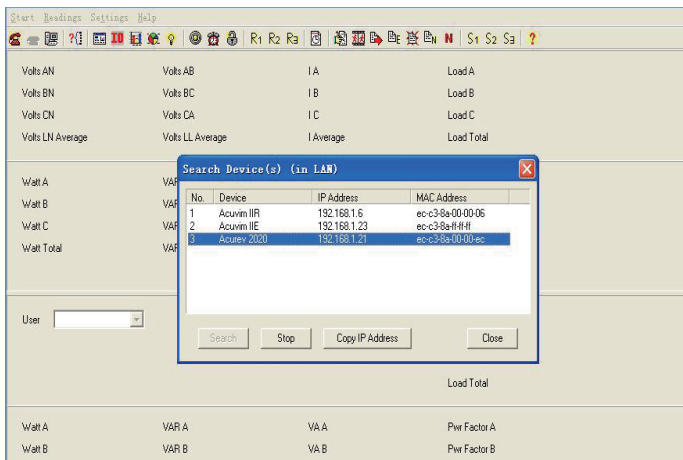

Figure 5-12

Note:This function is used only in LAN, not used in WAN or direct connect to computer.

5.3.8 Description of Modbus-TCP protocol

The Modbus-TCP protocol is used for communication in Ethernet modules. The protocol sets up master/slave link in Ethernet. First, master device (client) sets up TCP link with slave device (server). Second, master device sends request frame to slave device, and slave device receives request frame and returns response frame to master device. Figure 5-13 displays working mode of Modbus-TCP protocol.

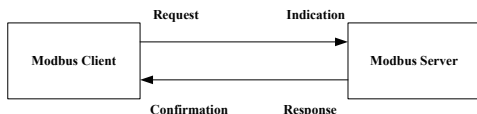

Figure 5-13

1. Protocol

a. Data Frame Format

Table 5-15

MBAP Header	Function	Data
7x8-Bits	8-Bits	Nx8-Bits

b. Modbus Application Header (MBAP Header) Field

The Modbus application header field is the start of the data frame and consists of seven bytes.

Table 5-16

Field	Length	Description
Transaction Identifier	2 Bytes	Identification of a Modbus Request/Response transaction
Protocol Identifier	2 Bytes	Modbus protocol=0
Length	2 Bytes	Number of following bytes
Unit Identifier	1 Byte	Slave address, in the range of 0~247 decimal.

c. Function Field

The function code field of a message frame contains eight bits. Valid codes are in the range of 1~255 decimal. When a message is sent from a client to a server device the function code field tells the server what kind of action to perform.

Table 5-17

Code	Meaning	Action
01	Read Relay Output Status	Obtain current status of Relay Output
02	Read Digital Input(DI) Status	Obtain current status of Digital Input
03	Read Data	Obtain current binary value in one or more registers
05	Control Single Relay Output	Force Relay to a state of on or off
16	Write Multiple-registers	Place specific value into a series of consecutive multiple-registers

d. Data Field

The data field is constructed using sets of two hexadecimal digits, in the range of 00 to FF hexadecimal. The data field of messages sent from a master to slave devices contains additional information which the slave must use to take the action defined by the function code. This can include items like discrete and register addresses, the quantity of items to be handled, and the count of actual data bytes in the field. For example, if the master requests a slave to read a group of holding registers (function code 03), and the data field specifies the starting register and how many registers are to be read. If the master writes to a group of registers in the slave (function code 10 hexadecimal), the data field specifies the starting register, how many registers to write, the count of data bytes to follow in the data field, and the data to be written into the registers.

2. Format of communication

Explanation of frame

Table 5-18

Transaction identifier hi	Transaction identifier lo	Protocol identifier hi	Protocol identifier lo	Length hi	Length lo	Unit identifier
00H	00H	00H	00H	00H	06H	01H
Fun	Data start reg hi	Data start reg lo	Data #of regs hi	Data #of regs lo		
03H	40H	00H	00H	48H		

As shown in Table 5-4 the meaning of each abbreviated word is:

Transaction identifier hi: Transaction Identifier high byte

Transaction identifier lo: Transaction Identifier low byte

Protocol identifier hi: Protocol Identifier high byte

Protocol identifier lo: Protocol Identifier low byte

Length hi: length high byte

Length lo: length low byte

Unit identifier: slave address

Fun: function code

Data start reg hi: start register address high byte

Data start reg lo: start register address low byte

Data #of regs hi: number of register high byte

Data #of regs lo: number of register low byte

a. Read Status Relay (Function Code 01)

Function Code 01

This function code is used to read relay status in AcuRev 2000 series meter.

1=On

0=Off

There are 8 Relays in the meter, and the starting address is 0000H.

The following query is to read 2 Relays Status of the meter Address 1.

Query

Table 5-19 Read 2 Relays Status Query Message

Transaction identifier hi	Transaction identifier lo	Protocol identifier hi	Protocol identifier lo	Length hi	Length lo	Unit identifier
00H	00H	00H	00H	00H	06H	01H

Fun	Data start reg hi	Data start reg lo	Data #of regs hi	Data #of regs lo
01H	00H	00H	00H	02H

Response

The AcuRev 2000 series meter response includes MBAP Header, function code, quantity of data byte and the data. For example response to read the status of Relay 1 and Relay 2 is shown as Table 5-6. The status of Relay 1 and Relay 2 is responding to the last 2 bit of the data.

Table 5-20 Read 2 Relays Status Response Message

Relay 1: bit0

Relay 2: bit1

Transaction identifier hi	Transaction identifier lo	Protocol identifier hi	Protocol identifier lo	Length hi	Length lo	Unit identifier
00H	00H	00H	00H	00H	04H	01H

Fun	Byte count	Data
01H	01H	02H

The content of the data is,

7	6	5	4	3	2	1	0
0	0	0	0	0	0	1	0

MSB

LSB

(Relay 1 = OFF , Relay 2=ON)

Response

An example response to read Time (2006-12-18 14:15:20) is shown as Table 5-10.

Table 5-21 Read Time Response Message

Transaction identifier hi	Transaction identifier lo	Protocol identifier hi	Protocol identifier lo	Length hi	Length lo	Unit identifier
00H	00H	00H	00H	00H	0FH	01H

Fun	Byte count	Data1 hi	Data1 lo	Data2 hi	Data2 lo	Data3 hi	Data3 lo	Data4 hi	Data4 lo	Data5 hi	Data5 lo	Data6 hi	Data6 lo
03H	0CH	07H	D6H	00H	0CH	00H	12H	00H	0EH	00H	0FH	00H	14H

d. Control Relay (Function Code 05)

Query

The message forces a single Relay either on or off. Any Relay that exists within the AcuRev 2000 series meter can be forced to be either status (on or off). The address of Relay starts at 0000H, and the meter has eight Relays.

The data value FF00H will set the Relay on and the value 0000H will turn it off; all other values are invalid and will not affect that relay.

The example below is a request to AcuRev 2000 series meter address 1 to turn on Relay 1.

Table 5-22 Control Relay Query Message

Transaction identifier hi	Transaction identifier lo	Protocol identifier hi	Protocol identifier lo	Length hi	Length lo	Unit identifier
00H	00H	00H	00H	00H	06H	01H

Fun	Data start reg hi	Data start reg lo	Value hi	Value lo
05H	00H	00H	FFH	00H

Response

The normal response to the command request is to retransmit the message as received after the Relay status has been altered.

Table 5-23 Control Relay Response Message

Transaction identifier hi	Transaction identifier lo	Protocol identifier hi	Protocol identifier lo	Length hi	Length lo	Unit identifier
00H	00H	00H	00H	00H	06H	01H

Fun	Data start reg hi	Data start reg lo	Value hi	Value lo
05H	00H	00H	FFH	00H

e. Preset/Reset Multi-Register (Function Code 16)

Query

Function code 16 allows the user to modify the contents of a Multi-Register. The example below is a request to an AcuRev 2000 series meter address 1 to Preset CT1 (500) and CT2 (5). CT1 data address is 1008H, and CT2 data address is 1009H.

Table 5-24 Preset CT Value Query Message

Transaction identifier hi	Transaction identifier lo	Protocol identifier hi	Protocol identifier lo	Length hi	Length lo	Unit identifier
00H	00H	00H	00H	00H	08H	01H

Fun	Data start reg hi	Data start reg lo	Data #of regs hi	Data #of regs lo	Byte count	Value1 hi	Value1 lo	Value2 hi	Value2 lo
10H	10H	08H	00H	02H	04H	01H	F4H	00H	05H

Response

The normal response to a preset Multi-Register request includes MBAP Header, function code, data start register and the number of registers.

Table 5-25 Preset Multi-Registers Response Message

Transaction identifier hi	Transaction identifier lo	Protocol identifier hi	Protocol identifier lo	Length hi	Length lo	Unit identifier
00H	00H	00H	00H	00H	06H	01H

Fun	Data start reg hi	Data start reg lo	Data #of regs hi	Data #of regs lo
10H	10H	08H	00H	02H

Users may refer to the sixth chapter “Communication” and get the details of AcuRev 2000 series meter.

When using Modbus/TCP function, it is best to set the Scan interval of the software to under 1000 ms.

When using Third Party software, it is best to set Frame interval for the Modbus-TCP function to under 1000 ms.

5.3.9 Webpage Browsing and Parameter Settings

The Ethernet module supports HTTP protocol and has a Web Server function making the AcuRev 2000 series meter accessible through Ethernet at anytime from anywhere.

The Ethernet module supports IE Browser 6.0 and higher editions and the Webpage Settings only support ASCII characters.

The IP address will be referred to as "192.168.1.200" for the remainder of this chapter.

1. Main page

Users enter the correct IP address and HTTP port of the module in the address bar of the web browser. This provides access to "Data", "Settings" and "Module Status".

ACUENERGY

Main Page **AcuRev 2000 Series Web Server**

Data

Settings

Module Status

AcuRev 2000 series performs real-time metering, measures energy consumption and monitors power quality for up to 16 single phase circuits (or 6 three phase circuits) in one unit. It is an advanced intelligent power meter that Accuenergy developed and manufactured for the next generation smart grids. The main features include multi-laminate submetering, cyclic display, tamper proof, which make it highly suitable for large commercial facilities, residential apartments and industrial environments. AcuRev 2000 series has infrared, RS485 and Ethernet communication options as well as I/O options (e.g. Pulse Counting from water or gas meters), making it useful in energy management systems. Due to its communication capability, ease of installation and use, this product can be easily integrated into new and existing energy management systems.

Areas of Application:

- Large Commercial Centers
- Railway Transportation
- Schools
- Public Infrastructures
- Hotel/Office Buildings
- Intelligent Power Distributions
- Condominium/Residential Buildings
- Energy Management Systems
- Industrial Environment
- Energy Saving Systems

Figure 5-14

2. Module Status Webpage

By selecting the "Module Status" link, users can view the status and change the settings of the Ethernet module.

ACUENERGY

Main Page

Data

Settings

Module Status

Device Description	AcuRev2000	Mail From	Acurev2000
DHCP Mode	MANUAL	Mail to #1	ac@acuenergy.com.cn
IP Address	132.168.1.21	Mail to #2	
Subnet Mask	255.255.255.0	Mail to #3	
Gateway	132.168.1.1	Subject	Metering
DNS Primary	132.168.1.4	SMTP Server	mail.acuenergy.com.cn
DNS Secondary	132.168.1.79	User Name	test1@acuenergy.com.cn
MODBUS Port	502	Triggered Sending	disabled
HTTP Port	80	Timed Sending	disabled
MAC Address	8c-12-0a-0c-00-ec	Mail Content	
Meter Model	AcuRev2020	Meter SN	CA010H12
Meter Firmware	2.01	NET Firmware	1.01
Default frequency	50Hz	Device Clock	2008-1-1 01:45

Figure 5-15

3. Settings Webpage

By selecting the "Settings" link, users can access "Network Settings", "Mail Settings", "Webpage Settings", "Load Default" and "Password Setting".

When accessing the "Settings" link, users will be prompted to enter a password. The default password is 12345678.

a. "Password" Webpage

Figure 5-16: "Password" webpage. If the password is valid, the browser will go to the "Network Settings" webpage. If an incorrect password is used, users will be notified of "Invalid Password".

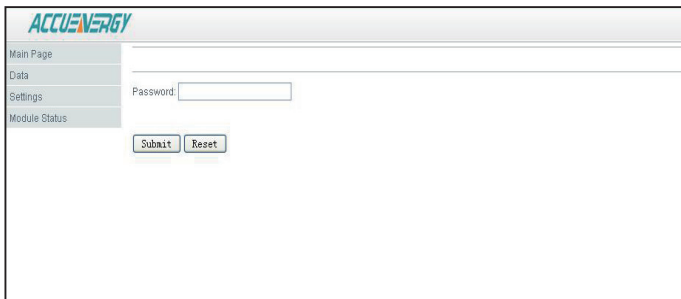

Figure 5-16

b. "Network Settings" Webpage

Figure 5-45: "Network Settings" webpage. There are two sections for you to set: Ethernet setting and SNTP setting. In Ethernet setting section, it supports two network setting modes: Manual or Auto. There are two port settings: HTTP port and Modbus-TCP port.

The default value of Modbus-TCP port is 502, and the user defined range is 2000~5999. The default value of HTTP port is 80, and the user defined range is 6000~9999.

In SNTP setting section, there are four contents:

- SNTP Enable, enable SNTP function.
- SNTP Interval, setup interval seconds which SNTP client check SNTP server. The default value is 10min, and the user defined range is 1-60000min.
- SNTP Server, setup SNTP Server which SNTP client update from. Please find available SNTP server from internet.
- Time Zone Selecting: select Time Zone which match your location.

ACCUEnergy

Main Page
Data
Settings
Module Status

Network Parameter Configuration

Manual Setting Auto Setting

Network Parameter:

IP Address: (Example: 192.168.1.254)

Subnet Mask: (Example: 255.255.255.0)

Gateway: (Example: 192.168.1.1)

DNS Primary Server: (Example: 202.106.0.20)

DNS Secondary Server: (Example: 202.106.196.115)

Port Setting:

MODBUS Port: (Default: 502, Scope: 2000~5999)

HTTP Port: (Default: 80, Scope: 6000~9999)

SNTP Setting: (Please restart AXMINET Module after SNTP setting.)

SNTP Enable

SNTP Interval: min (Default: 10, Scope: 1~60000)

SNTP Server:

Time Zone Selecting:

(UTC+08:00) ▼

Figure 5-17

c. "Mail Settings" Webpage

Figure 5-18: "Mail Settings" webpage. Users can choose between 4 mail sending modes: "Triggered Sending", "Timed Sending", both "Triggered and Timed Sending" and "None". Boxes marked with "*" cannot be left blank. "Triggered Sending" means users will receive mail when the meter detects a new event, such as an "Alarm Event", "SOE Event" or "System Event". "Timed Sending" means users can receive mail every 5~1440 minutes (user settable) reporting "Metering", "Energy", "Demand", "Max/Min", "Alarm Record", "SOE Record" and "System Record".

Sending Modes can be set as follows:

Setting "Triggered Sending" mode: users can select one or all of the checkboxes below. Triggered Sending includes "Alarm Event", "SOE Event" and "System Record" as seen in Figure 5-18. Triggered Sending mode is disabled if neither "Alarm Event", "SOE Event" or "System Event" is selected.

Setting "Timed Sending" mode: users enter a number between 5 and 1440 minutes into the box beside "Timed Sending". This number is the interval time between mail. Sending mode is disabled if 0 is entered. Users can also select which parameters to receive reports on by checking the checkboxes below "Timed Sending" in Figure 5-46. Setting both "Triggered Sending" and "Timed Sending" mode: users follow the steps for both "Triggered Sending" and "Timed Sending" above.

"None" mode: users disable both "Triggered Sending" and "Timed Sending" modes.

Note: Mail Server part includes "SMTP Server", "User Name" and "Password". For the "SMTP Server" users can input either domain name such as "mail.accuenergy.com" or an IP address such as "222.128.6.73" which is from "mail.accuenergy.com" resolved. A user name and password will be required to log in.

ACCUEnergy

Main Page
Data
Settings
Module Status

Mail Information

Mail From: * (Example: Technical Support)

Mail To #1: * (Example: abc@accuenergy.com)

Mail To #2: (Example: abc@gmail.com)

Mail To #3: (Example: abc@yahoo.com)

Subject: * (Example: test mail)

Mail Server

SMTP Server: *

User Name: *

Password: *

Mail Content

Triggered Sending:

Alarm Event SOE Event System Event

Timed Sending: min * (Time Scope: 5-1440min, 0 for disable)

Metering Energy Harmonics Demand Alarm Record SOE Record System Record

Figure 5-18

d. "Web Configuration Settings" Webpage

Figure 5-19: "Webpage Settings" page. Users set the "Device Description" according to the meter type.

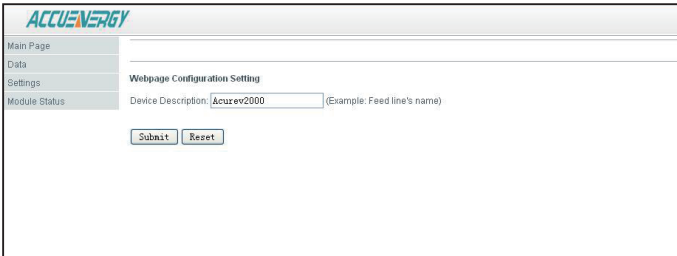

ACCUENERGY	
Main Page	
Data	
Settings	Webpage Configuration Setting
Module Status	Device Description: <input type="text" value="Acuzev2000"/> (Example: Feed line's name)
<input type="button" value="Submit"/> <input type="button" value="Reset"/>	

Figure 5-19

e. "Management" webpage

Figure 5-20: "Management" webpage. Users can easily update the software online by selecting the updated file, which can be got from Accuenergy Corporation. The "Reboot NET module" option resets the module itself.

IP Address:192.168.1.254

Subnet Mask:255.255.255.0

Gateway:192.168.1.1

DNS Primary: 202.106.0.20

DNS Secondary: 202.106.196.115

MODBUS Port: 502

HTTP Port: 80

ACCUENERGY

Main Page

Data

Settings

Module Status

Please select an updated file!

浏览...

(Note: Reboot the NET module after the update!)

Update

Load Default Setting

Reboot NET Module

Submit

Figure 5-20

f. "Password Setting" Webpage

Figure 5-21: "Password Setting" webpage. To change the password, users need to input the current password first.

ACCUENERGY

Main Page

Data

Settings

Module Status

Change Password

Current Password:

New Password: (6 -12bits)

Confirm Password: (6 -12bits)

Submit Reset

Figure 5-21

4. Data Webpage

Click "Data" Link to Visit Data webpages. There are eight kinds of data webpages. They are "Metering" webpage, "Demand" webpage, "Energy" webpage, "Harmonics" webpage, "IO Status" webpage, "Alarm Record" webpage, "SOE Record" webpage and "System Record" webpage. Each webpage shows the working status of the meter.

"Metering" webpage includes the data of real-time parameters for Acurev 2000 series meter, such as Volts AN, I A, Watt A of inline and each user.

"Demand" webpage includes the demand data for Acurev 2000 series meter, such as real-time value, predictive value, maximum value and the maximum value timestamp of inline and each user.

"Energy" webpage includes the energy data for Acurev 2000 series meter, such as Delivered kWh, kVAh of inline and each user.

"Harmonics" webpage includes harmonics parameters for Acurev 2000 series meter, such as THD Volts Average of inline and each user.

"IO Status" webpage includes RO status, DI status or DI counters, DI value and DI unit.

"Alarm Record" webpage includes alarm records for Acurev 2000 series meter. There are twenty records. Each record includes Time Stamp, Limit ID, Status, Alarm Channel and Value.

"SOE Record" webpage includes SOE record for Acurev 2000 series meter. There are twenty records. Each record includes Time Stamp and DI Status.

"System Record" webpage includes system record for Acurev 2000 series meter. There are one hundred records. Each record includes Time Stamp and system event.

ACUENERGY	
Main Page	AcuRev 2000 Series Web Server
Data	Metering
Settings	Demand
Module Status	Energy
	Harmonics
	IO Status
	Alarm Record
	SOE Record
	System Record
	<ul style="list-style-type: none"> ■ Oil/Gas ■ Public Infrastructures ■ Hotel/Office Buildings ■ Intelligent Power Distributions ■ Condominium/Residential Buildings ■ Energy Management Systems ■ Industrial Environment ■ Energy Saving Systems

Figure 5-22

5.3.10 Email Function

The Ethernet module supports SMTP protocol, which provides email capabilities. Before sending emails, users must set their own DNS Server. Please refer to "Network settings" which includes DNS Server setting.

Please note, as per 3.c of Section 5.3.9, there are three modes users can select. The first is "Triggered Sending", which means once new events happen, users can receive email notifications immediately. The second is "Timed Sending" mode. Users can receive emails based on preset time intervals (5~1440 minutes), which include all information on "Data" webpage.

The third mode is a combination of "Triggered Sending" and "Timed Sending".

5.3.11 SNMP Function

Ethernet communication supports SNMP (Simple Network Management Protocol) protocol, so you can get data from the meter through SNMP, by get, get-next, and walk instructions. To master this manual, you suppose to be familiar with SNMP protocol, and you have generously mastered the function and application of this product.

We will show you an example of how to use SNMP server software to get data from the meter. The example is showed by MG-SOFT MIB Browser Professional SNMPv1/v2c Edition 2010.

NOTE: MG-SOFT MIB Browser Professional is the production of MG-SOFT Corporation, and its copyrights are reserved by MG-SOFT Corporation. We will not supply MG-SOFT MIB Browser Professional with our meters.

1. Compile MIB

After installed MG-SOFT MIB Browser Professional, you can load Acurev 2000.mib file by MIB Compiler, which is one part of MG-SOFT MIB Browser Professional.

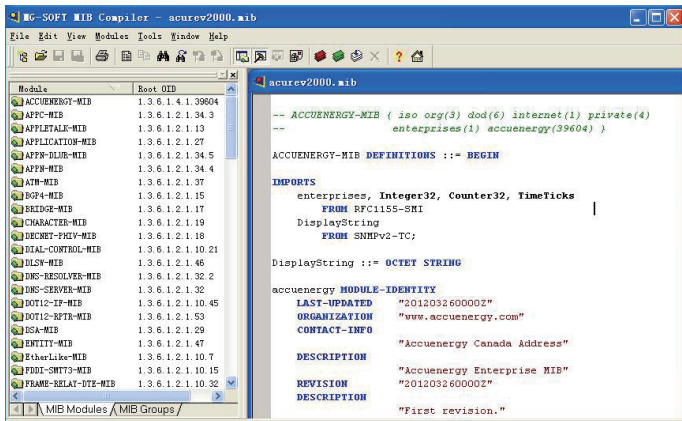

Figure 5-23

Using F7 on keyboard to compile this MIB,then select ACCUENERGY-MIB,select Save.

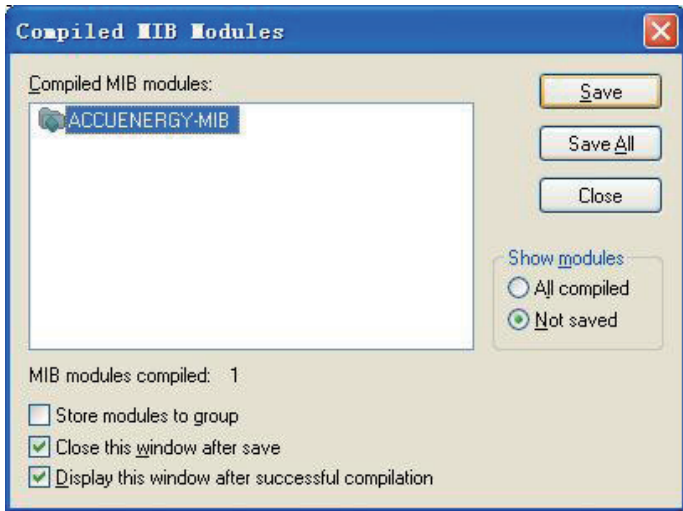

Figure 5-24

After successfully adding Acurev 2000 MIB,there should show ACCUENERGY-MIB in MIB Modules, which OID is 1.3.6.1.4.1.39604.

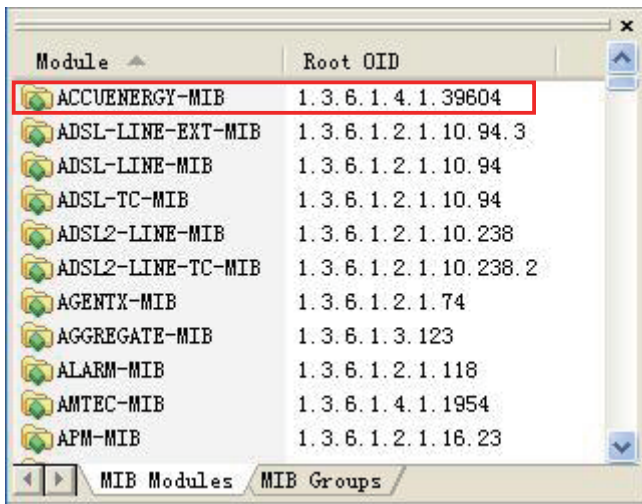

Figure 5-25

2. Load ACCUENERGY-MIB

Opening MIB Browser, which is part of MG-SOFT,select MIB Table, then load ACCUENERGY-MIB from MIB Modules,unload unnecessary MIBs from Loaded MIB modules.

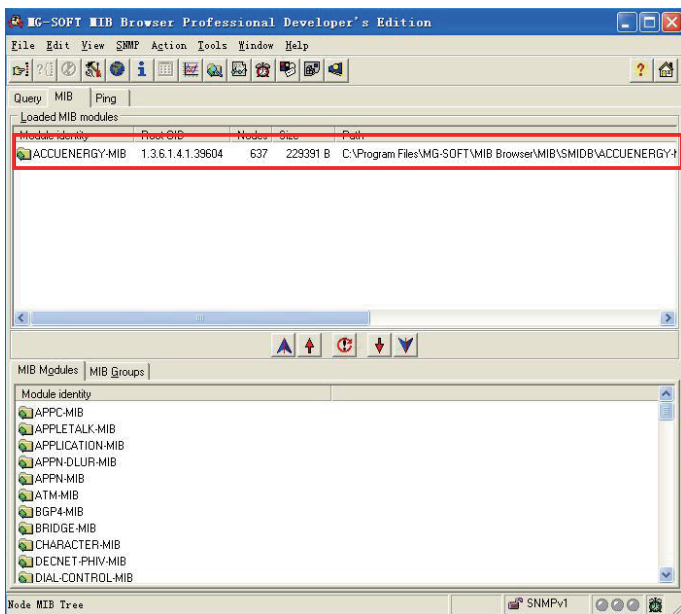



Figure 5-26

3. Contact SNMP Agent

Change to Query Label, input IP address under Remote SNMP agent, such as 192.168.1.249, select Contact button  , if the SNMP agent works on this IP, it will return like this,

Remote address: 192.168.1.249 port: 161 transport: IP/UDP

Local address: 192.168.1.126 port: 3592 transport: IP/UDP

Protocol version: SNMPv1

1: [Loaded: RFC-1215] sysUpTime.0 (timeticks) 0 days 20h:11m:50s.23th (7271023)

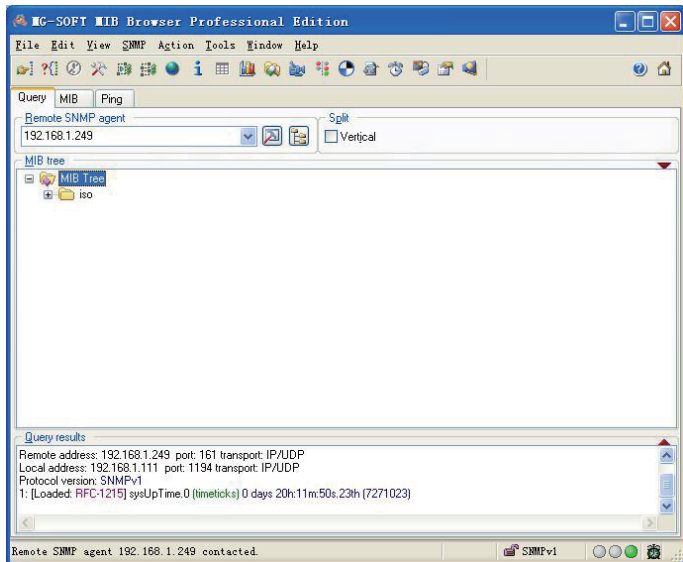

Figure 5-27

4. Walk the MIB

Right Click on the tree root, then expand MIB, find Acurev 2000 OID, right click to select walk, then query whole acurev 2000 MIB.

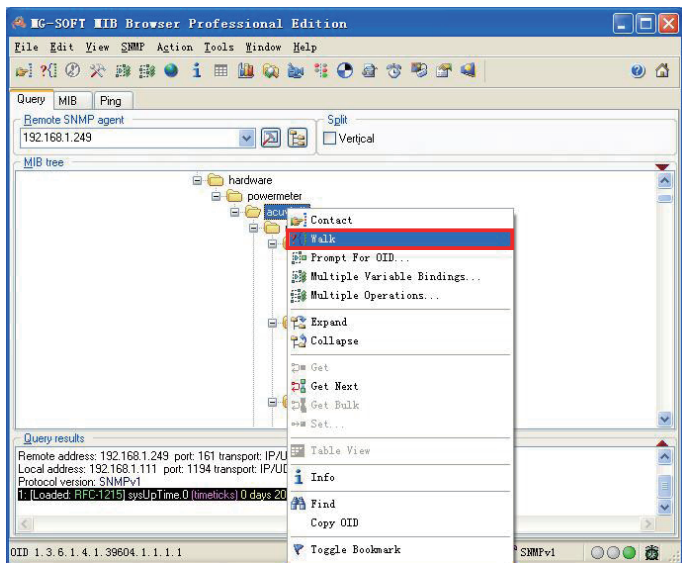

Figure 5-28

QUERY returns like these,

***** SNMP QUERY STARTED *****

1: phaseVoltageA.0 (integer) 0

2: phaseVoltageB.0 (integer) 0

3: phaseVoltageC.0 (integer) 0

4: averagePhaseVoltage.0 (integer) 0

5: lineVoltageAB.0 (integer) 30540

.....

582: user16MappingRelationships.0 (integer) 272

583: user17Name.0 (octet string) user17 [75.73.65.72.31.37 (hex)]

584: user17MappingRelationships.0 (integer) 273

585: user18Name.0 (octet string) user18 [75.73.65.72.31.38 (hex)]

586: user18MappingRelationships.0 (integer) 277

587: threePhaseInputWiringType.0 (integer) 2

***** SNMP QUERY FINISHED *****

5. Get a value

Right Click on one MIB OID, which you want to query, then select Get  , and then return the OID value.

For example, the followings demonstrate the result of getting the value of phaseVoltageA.

Operation: Get

Request binding:

1: phaseVoltageA.0 (null) null

Response binding:

1: phaseVoltageA.0 (integer) 0

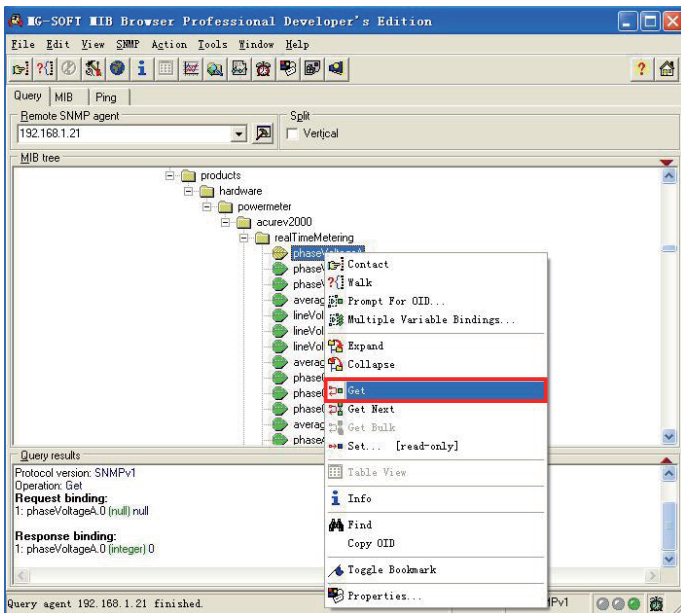

Figure 5-29

5.3.12 SNTP Function

Ethernet communication supports SNTP (Simple Network Time Protocol) protocol, so meters can get update time to Coordinated Universal Time (UTC). Please find the SNTP Settings – Network Settings by Internet Explorer,



The image shows a screenshot of a software settings window for SNTP. It contains the following elements:

- A checked checkbox labeled "SNTP Enable".
- A text field for "SNTP Interval" containing the value "10", followed by the text "min (Default: 10, Scope: 1~60000)".
- A text field for "SNTP Server" containing the value "time.windows.com".
- A label "Time Zone Selecting:" followed by a dropdown menu.
- The dropdown menu is currently open, showing the selected option "(UTC+08:00) Beijing, Chongqing, Hong Kong, Urumqi".
- At the bottom, there are two buttons: "Submit" and "Reset".

Figure 5-30

5.4 Application Details and Parameter Address Table

1. Data Type

"Bit" is binary value;

"Word" is 16-bit unsigned integer, using one register address, 2 bytes. The data range is 0-65535.

"int" is 16-bit signed integer, using one register address, 2 bytes. The data range is -32768-32767.

"dword" is 32-bit unsigned integer, using two register addresses, high bytes followed by low bytes, using 4 bytes in total. The data range is 0-4294967295; Rx = High Word x 65536 + Low Word.

"float" is single precision floating point, using two register addresses, 4 bytes. The data range is 0.0-3.402823E +38.

2. The relationship between communication value and real value

The meter's communication value does not always equal the real value. There is a conversion relationship between them. It is very important to be aware of the parameter relationship when users design a communication software, otherwise the result may be incorrect.

Parameter	Relationship	Unit
System Parameter, Status, Parameter	The communication value equals the real value	No Unit
Meter and Battery runtime	$T=R_x/100$	Hour
Real-time Clock, Timestamp	The communication value equals the real value	Time Unit
Energy	$E=R_x/10$ (A decimal)	Ep: kWh Eq: kvarh Es: kVAh
Demand	The communication value equals the real value	Dp: kW Dq: kvar Ds: kVA I: A
Frequency	The communication value equals the real value	Hz
Power Factor	The communication value equals the real value	No Unit
Voltage	The communication value equals the real value	Volt
Current	The communication value equals the real value	Ampere
Unbalance	$Unbl=(R_x/1000) \times 100\%$	No Unit
Total Harmonic distortion	$THD=(R_x/10000) \times 100\%$	No Unit
All times Harmonic ratio	$HDn=(R_x/10000) \times 100\%$	No Unit
Odd harmonic ratio	$HDo=(R_x/10000) \times 100\%$	No Unit
Even harmonic ratio	$HDe=(R_x/10000) \times 100\%$	No Unit
Crest Factor	$CF = R_x/1000$	No Unit
K-factor	$KF = R_x/10$	No Unit
Phone Form Factor	$THFF=(R_x/10000) \times 100\%$	No Unit
Pulse Counted	Value = $R_x/100$	According to settings

Table 5-26 The relationship between communication value and real value (R_x is the communication value)

3. Parameter Address Table

System Settings

Users should thoroughly understand the system settings as they contribute to the meter operation mode. The details on system settings can be found in Chapter 4.

Function Code 10H: Write, 03H: Read

Address	Parameter	Property	Range	Default	Date Type
800H	Meter Address	R/W	1-247	1	word
801H	Channel 1 485 communication Modbus parity bit setting	R/W	0: Even parity 1: Odd parity 2: No parity 2 3: No parity 1	3	word
802H	Infrared communication parity bit setting	R/W	0: Even parity 1: Odd parity 2: No parity Stop Bit 2 3: No Parity, Stop Bit 1	3	word
803H	Channel 1 485 communication Modbus baud rate	R/W	1200-38400	9600	word
804H	Infrared communication baud rate	R/W	1200-38400	9600	word
805H	Password	R/W	0000-9999	0000	word
806H	Energy Pulse constant	R/W	500-20000	5000	word
807H	Energy Pulse width	R/W	20-100ms	80	word

808H	DO1 Energy Pulse Output setting	R/W	See Appendix B	0	word
809H	DO1 Energy Pulse Output setting	R/W	Same as above	0	word
80AH	Demand calculation	R/W	0: Sliding Window 1: Rolling Window 2: Fixed Window 3: Thermal	0	word
80BH	Primary Demand Window	R/W	1-30 minutes	15	word
80CH	Secondary Demand Window	R/W	1-30 minutes	1	word
80DH	DI Synchronization Source	R/W	1-8: DI1-DI8 as Synchronization Source	1	word
80EH	DI Triggering Condition	R/W	0: No Triggering 1: Rising Edge 2: Falling Edge 3: By Changes	0	word
80FH	DI Working Mode	R/W	bit0-bit7 correspond to DI1-DI8 0: State Monitoring 1: Pulse Counter	0	word
810H-817H	DI1-8 Pulse Constant for each channel	R/W	1-65535	1	word
818H-81FH	DI Category, x8	R/W	i.e. one pulse represents 20 tons water	1	word

820H-827H	DI Unit, x8	R/W	1: t(ton) 2: m3(cubic meter) 3: kWh 4: (RMB) 5: \$(US Dollar)	1	word
828H	Relay Output Working Mode	R/W	bit0-bit3 correspond to RO1-RO4 0: Relay Control 1: Alarming	0	word
829H	Relay Control Mode	R/W	bit0-bit3 correspond to RO1-RO4 0: Latching 1: Momentary	0	word
82AH	Relay Control Momentary Time	R/W	50-3000ms	80	word
82BH	Alarming Feature	R/W	0: Disable 1: Enable	0	word
82CH	1-10 Alarming Channel	R/W	Bit0-bit9 correspond to 1-10 alarming channels 1: Active 0: Inactive	0	word
82DH	Each event alarm is sent to RO feature bit. 2 bytes represent 16 events sent to RO feature	R/W	Bit0-15 correspond to 16 Events 1: Enable 0: Disable	0	word

82EH	RO alarming, each one of the first 8 events corresponds to RO settings	R/W	2 Bytes. Every 2 bit correspond to one event, the RO number is: 00 RO1 01 RO2 10 RO3 11 RO4	0	word
82FH	Same as above, the last 8 events	R/W	2 Bytes. Every 2 bits correspond to one event, the RO number is: 00 RO1 01 RO2 10 RO3 11 RO4	0	word
830H	RO alarming time delay, not applicable to over/under limit alarming	R/W	1-60000 second	60	word
831H	Backlight time	R/W	0-60 minute	1	word
832H	Automatic display if no key is pressed in how long	R/W	1-60(minute)	1	word
833H	Automatic Display, each screen duration	R/W	5-100(second)	5	word
834H	Display Power (demand) decimal place	R/W	3-4 digit	3	word
835H	Reactive Power	R/W	0: True 1: Generalized	0	word

836H	VAR/PF Convention	R/W	0: IEC 1: IEEE	0	word
837H	Clear all data digits to clear all records	R/W	See Appendix	0	word
838H	DI Pulse Counter clear	R/W	bit0-bit7 correspond to DI1-DI8, 1 means clearing the counter	0	word
839H-83EH	645 Address	R/W		0	word
83FH-841H	user01 user name	R/W	User name(6 ASCII)	user01	Word
842H	user01 Mappings	R/W	High byte: 0: The display module does not display the user 1: The display module displays the user Low byte: 0: Disable 1-18: The corresponding physical channel 19-24: corresponding channel 1-6 three-phase users	0x0101	Word
843H-845H	user02 user name	R/W	user name (6 ASCII)	user02	Word

846H	Mappings	R/W	High byte: 0: The display module does not display the user 1: The display module displays the user Low byte: 0: Disable 1-18: The corresponding physical channel 19-24: corresponding channel 1-6 three-phase users	0x0102	Word
847H-849H	user03 user name	R/W	user name (6 ASCII)	user03	Word
84AH	Mappings	R/W	High byte: 0: The display module does not display the user 1: The display module displays the user Low byte: 0: Disable 1-18: The corresponding physical channel 19-24: corresponding channel 1-6 three-phase users	0x0103	Word
84BH-84DH	user04 user name	R/W	user name (6 ASCII)	user04	Word

84EH	Mappings	R/W	High byte: 0: The display module does not display the user 1: The display module displays the user Low byte: 0: Disable 1-18: The corresponding physical channel 19-24: corresponding channel 1-6 three-phase users	0x0104	Word
84FH-851H	user05 user name	R/W	user name (6 ASCII)	user05	Word
852H	Mappings	R/W	High byte: 0: The display module does not display the user 1: The display module displays the user Low byte: 0: Disable 1-18: The corresponding physical channel 19-24: corresponding channel 1-6 three-phase users	0x0105	Word
853H-855H	user06 user name	R/W	user name (6 ASCII)	user06	Word

856H	Mappings	R/W	High byte: 0: The display module does not display the user 1: The display module displays the user Low byte: 0: Disable 1-18: The corresponding physical channel 19-24: corresponding channel 1-6 three-phase users	0x0106	Word
857H-859H	user07 user name	R/W	user name (6 ASCII)	user07	Word
85AH	Mappings	R/W	High byte: 0: The display module does not display the user 1: The display module displays the user Low byte: 0: Disable 1-18: The corresponding physical channel 19-24: corresponding channel 1-6 three-phase users	0x0107	Word
85BH-85DH	user08 user name	R/W	user name (6 ASCII)	user08	Word

85EH	Mappings	R/W	High byte: 0: The display module does not display the user 1: The display module displays the user Low byte: 0: Disable 1-18: The corresponding physical channel 19-24: corresponding channel 1-6 three-phase users	0x0108	Word
85FH-861H	user09 user name	R/W	user name (6 ASCII)	user09	Word
862H	Mappings	R/W	High byte: 0: The display module does not display the user 1: The display module displays the user Low byte: 0: Disable 1-18: The corresponding physical channel 19-24: corresponding channel 1-6 three-phase users	0x0109	Word
863H-865H	user10 user name	R/W	user name (6 ASCII)	user10	Word

866H	Mappings	R/W	High byte: 0: The display module does not display the user 1: The display module displays the user Low byte: 0: Disable 1-18: The corresponding physical channel 19-24: corresponding channel 1-6 three-phase users	0x010a	Word
867H-869H	user11 user name	R/W	user name (6 ASCII)	user11	Word
86AH	Mappings	R/W	High byte: 0: The display module does not display the user 1: The display module displays the user Low byte: 0: Disable 1-18: The corresponding physical channel 19-24: corresponding channel 1-6 three-phase users	0x010b	Word
86BH-86DH	user12 user name	R/W	user name (6 ASCII)	user12	Word

86EH	Mappings	R/W	High byte: 0: The display module does not display the user 1: The display module displays the user Low byte: 0: Disable 1-18: The corresponding physical channel 19-24: corresponding channel 1-6 three-phase users	0x010c	Word
86FH-871H	user13 user name	R/W	user name (6 ASCII)	user13	Word
872H	Mappings	R/W	High byte: 0: The display module does not display the user 1: The display module displays the user Low byte: 0: Disable 1-18: The corresponding physical channel 19-24: corresponding channel 1-6 three-phase users	0x010d	Word
873H-875H	user14 user name	R/W	user name (6 ASCII)	user14	Word

876H	Mappings	R/W	High byte: 0: The display module does not display the user 1: The display module displays the user Low byte: 0: Disable 1-18: The corresponding physical channel 19-24: corresponding channel 1-6 three-phase users	0x010e	Word
877H-879H	user15 user name	R/W	user name (6 ASCII)	user15	Word
87AH	Mappings	R/W	High byte: 0: The display module does not display the user 1: The display module displays the user Low byte: 0: Disable 1-18: The corresponding physical channel 19-24: corresponding channel 1-6 three-phase users	0x010f	Word
87BH-87DH	user16 user name	R/W	user name (6 ASCII)	user16	Word

87EH	Mappings	R/W	High byte: 0: The display module does not display the user 1: The display module displays the user Low byte: 0: Disable 1-18: The corresponding physical channel 19-24: corresponding channel 1-6 three-phase users	0x0110	Word
87FH-881H	user17 user name	R/W		user17	Word
882H	Mappings	R/W	High byte: 0: The display module does not display the user 1: The display module displays the user Low byte: 0: Disable 1-18: The corresponding physical channel 19-24: corresponding channel 1-6 three-phase users	0x0111	Word
883H-885H	user18 user name	R/W	user name (6 ASCII)	user18	Word

886H	Mappings	R/W	High byte: 0: The display module does not display the user 1: The display module displays the user Low byte: 0: Disable 1-18: The corresponding physical channel 19-24: corresponding channel 1-6 three-phase users	0x0112	Word
887H	Load voltage rating setting	R/W	Default 220V	220	Word
888H	Connection mode of three-phase user	R/W	0: No three-phase wiring 1LN 1: Three-phase user wiring is 3LN (three-phase four-wire) 2: Three-phase user wiring is 2LN (single-phase three-wire)	0	word
889H	Channel 1 CT Specifications	R/W	Note: EM effective, DM invalid Can be set, for example: 20: CCT-20 (full scale 20A) 80: CCT-80 (full scale 80A) 150: CCT-150 (full scale 150A) 200: CCT-200 (full scale 200A)	20	Word
88AH	Channel 2 CT Specifications	R/W	Same as above	20	Word
88BH	Channel 3 CT Specifications	R/W	Same as above	20	Word
88CH	Channel 4 CT Specifications	R/W	Same as above	20	Word

88DH	Channel 5 CT Specifications	R/W	Same as above	20	Word
88EH	Channel 6 CT Specifications	R/W	Same as above	20	Word
88FH	Channel 7 CT Specifications	R/W	Same as above	20	Word
890H	Channel 8 CT Specifications	R/W	Same as above	20	Word
891H	Channel 9 CT Specifications	R/W	Same as above	20	Word
892H	Channel 10 CT Specifications	R/W	Same as above	20	Word
893H	Channel 11 CT Specifications	R/W	Same as above	20	Word
894H	Channel 12 CT Specifications	R/W	Same as above	20	Word
895H	Channel 13 CT Specifications	R/W	Same as above	20	Word
896H	Channel 14 CT Specifications	R/W	Same as above	20	Word
897H	Channel 15 CT Specifications	R/W	Same as above	20	Word
898H	Channel 16 CT Specifications	R/W	Same as above	20	Word
899H	Channel 17 CT Specifications	R/W	Same as above	20	Word
89AH	Channel 18 CT Specifications	R/W	Same as above	20	Word

89BH-8ACH	Reserved				
8ADH	Restore the default parameters (User name and mappings, and CT wiring specifications)	R/W	0: no action 0xAA: Restore factory settings Note: The recovery zone for the user name, CT specifications, three-phase wiring	0	Word
8AEH	A decade setting load enable	R/W	1: Enable active	0	Word
8AFH	Sealed Nonstandard Parameters Selection	R/W	Bit0: RS485 communication parameters and infrared communication parameters Bit1: Network parameters Bit2: Clear Meter Run Time Bit3: DI pulse counting Bit4: TOU Bit5: RO 1: valid of corresponding selection 0: invalid of corresponding selection	0	Word
8B0H	Seals status	R	0x0A: Seal sealed; Other: Seal opened.	0x0	Word
8B1H-8BF	Reserved				

Clear

Bit7	Bit6	Bit5	Bit4	Bit3	Bit2	Bit1	Bit0
1 to clear	1 to clear	1 to clear	1 to clear	1 to clear	1 to clear	1 to clear	1 to clear

Reserve	Clear battery runtime	Clear meter runtime	Clear event records	Clear alarm records	Clear SOE records	Clear demand	Clear this month and historical energy
---------	-----------------------	---------------------	---------------------	---------------------	-------------------	--------------	--

Meter and Battery Runtime

Function Code 03: Read. Data Type: Word

Address	Parameter	Property	Range	Default	Data Type
1050H-1051H	Meter Runtime	R			Dword
1052H-1053H	Battery Runtime	R			Dword

Clock

Function Code 03: Read, Function Code 16: Write. Date Type: Word

Address	Parameter	Property	Range	Default	Data
1054H	Year	R/W	0-99		Word
1055H	Month	R/W	1-12		Word
1056H	Day	R/W	1-31		Word
1057H	Hour	R/W	0-23		Word
1058H	Minute	R/W	0-59		Word
1059H	Second	R/W	0-59		Word
105AH	Week	R/W	0-6, 0 Sunday		Word

Over/Under Limit Alarming

There are a total of 10 groups for alarming, each group follows the same format. Function

Code 03: Read. Function Code 16: Write.

Address	Parameter	Property	Range	Default	Data
105BH	Group 1: Parameter Number	R/W	0~352	0	Integer
105CH	Group 1: Comparison	R/W	1: larger than 2: equal to 3: smaller than	1	Integer
105DH	Group 1: Set Value	R/W	Related percentage		Integer
105EH	Group 1: Delay Time	R/W	0~30000ms	0	Integer
105FH	Group 1: Output to RO	R/W	0: disabled 1-4: RO number	0	Integer
1060H-1064H	Group 2 setup	R/W	The same as Group 1		Integer
1065H-1069H	Group 3 setup	R/W	The same as Group 1		Integer
106AH-106EH	Group 4 setup	R/W	The same as Group 1		Integer
106FH-1073H	Group 5 setup	R/W	The same as Group 1		Integer
1074H-1078H	Group 6 setup	R/W	The same as Group 1		Integer
1079H-107DH	Group 7 setup	R/W	The same as Group 1		Integer
107EH-1082H	Group 8 setup	R/W	The same as Group 1		Integer
1083H-1087H	Group 9 setup	R/W	The same as Group 1		Integer

1088H-108CH	Group 10 setup	R/W	The same as Group 1		Integer
-------------	----------------	-----	---------------------	--	---------

Time of Use Parameter Setup

Before time of address 109F is the basic parameters for the setting, then the time zone, time tables and holidays specific settings.

Up to 14 time zones, eight times tables, 14 hours, 30 holidays. Two error status word is used to indicate that when parameter setting wrong

Function Code 03: Read, Function Code 10: Write

Address	Parameter	Property	Range	Default	Data Type
1090H	Error word 1(basic parameter)	R	See Appendix		Word
1091H	Error word 2(schedule table)	R	See Appendix		Word
1092H	Current Tariff	R	1~4	1	Word
1093H	Season	R/W	1~14	2	Word
1094H	Schedule Table	R/W	1~8	2	Word
1095H	Schedule	R/W	1~14	9	Word
1096H	Tariff	R/W	1~4	4	Word
1097H	Weekend	R/W	Bit0-7 1: ON, 0: OFF	0x7F	Word
1098H	Weekend Schedule	R/W	1-8	2	Word
1099H	Holiday	R/W	0-30	0	Word

109AH	TOU Energy monthly settle up	R/W	1: special day 0: end of month	0	Word
109BH	TOU Energy Special Day settle up: Day	R/W	1~28	1	Word
109CH	TOU Energy Special Day settle up: Time	R/W	0~23	0	Word
109DH	TOU Energy Enable	R/W	1	1	Word
109EH	TOU Energy reset to factory	R/W	1		Word
109FH-10AFH	Reserved				
10B0H-10B2H	Season 1(month, Day, Schedule Table Number)	R/W			Word
10B3H-10B5H	Season 2(month, Day, Schedule Table Number)	R/W			Word
10B6H-10B8H	Season 3(month, Day, Schedule Table Number)	R/W			Word
10B9H-10BBH	Season 4(month, Day, Schedule Table Number)	R/W			Word
10BCH-10BEH	Season 5(month, Day, Schedule Table Number)	R/W			word
10BFH-10C1H	Season 6(month, Day, Schedule Table Number)	R/W			Word

10C2H-10C4H	Season 7(month, Day, Schedule Table Number)	R/W			Word
10C5H-10C7H	Season 8(month, Day, Schedule Table Number)	R/W			Word
10C8H-10CAH	Season 9(month, Day, Schedule Table Number)	R/W			Word
10CBH-10CDH	Season 10(month, Day, Schedule Table Number)	R/W			Word
10CEH-10D0H	Season 11(month, Day, Schedule Table Number)	R/W			Word
10D1H-10D3H	Season 12(month, Day, Schedule Table Number)	R/W			Word
10D4H-10D6H	Season 13(month, Day, Schedule Table Number)	R/W			Word
10D7H-10D9H	Season 14(month, Day, Schedule Table Number)	R/W			Word
10DAH-10DCH	Schedule Table 1, 1st schedule (Hour, Minute, Tariff Number)	R/W			Word
10DDH-10DFH	Schedule Table 1, 2nd schedule (Hour, Minute, Tariff Number)	R/W			Word

10E0H-10E2H	Schedule Table 1, 3rd schedule (Hour, Minute, Tariff Number)	R/W			Word
10E3H-10E5H	Schedule Table 1, 4th schedule (Hour, Minute, Tariff Number)	R/W			Word
10E6H-10E8H	Schedule Table 1, 5th schedule (Hour, Minute, Tariff Number)	R/W			Word
10E9H-10EBH	Schedule Table 1, 6th schedule (Hour, Minute, Tariff Number)	R/W			Word
10ECH-10EEH	Schedule Table 1, 7th schedule (Hour, Minute, Tariff Number)	R/W			Word
10EFH-10F1H	Schedule Table 1, 8th schedule (Hour, Minute, Tariff Number)	R/W			Word
10F2H-10F4H	Schedule Table 1, 9th schedule (Hour, Minute, Tariff Number)	R/W			Word
10F5H-10F7H	Schedule Table 1, 10th schedule (Hour, Minute, Tariff Number)	R/W			Word

10F8H-10FAH	Schedule Table 1, 11th schedule (Hour, Minute, Tariff Number)	R/W			Word
10FBH-10FDH	Schedule Table 1, 12th schedule (Hour, Minute, Tariff Number)	R/W			Word
10FEH-1100H	Schedule Table 1, 13th schedule (Hour, Minute, Tariff Number)	R/W			Word
1101H-1103H	Schedule Table 1, 14th schedule (Hour, Minute, Tariff Number)	R/W			Word
1104H-112DH	Schedule Table 2, 1st-14th schedule (Hour, Minute, Tariff Number)	R/W	The same as Schedule Table 1		Word
112EH-1157H	Schedule Table 3, 1st-14th schedule (Hour, Minute, Tariff Number)	R/W	The same as Schedule Table 1		Word
1158H-1181H	Schedule Table 4, 1st-14th schedule (Hour, Minute, Tariff Number)	R/W	The same as Schedule Table 1		Word
1182H-11ABH	Schedule Table 5, 1st-14th schedule (Hour, Minute, Tariff Number)	R/W	The same as Schedule Table 1		Word

11ACH-11D5H	Schedule Table 6, 1st-14th schedule (Hour, Minute, Tariff Number)	R/W	The same as Schedule Table 1		Word
11D6H-11FFH	Schedule Table 7, 1st-14th schedule (Hour, Minute, Tariff Number)	R/W	The same as Schedule Table 1		Word
1200H-1229H	Schedule Table 8, 1st-14th schedule (Hour, Minute, Tariff Number)	R/W	The same as Schedule Table 1		Word
122AH-122CH	The 1st Holiday(Month, Day, Schedule Number)	R/W			Word
122DH-122FH	The 2nd Holiday(Month, Day, Schedule Number)	R/W			Word
1230H-1232H	The 3rd Holiday(Month, Day, Schedule Number)	R/W			Word
1233H-1235H	The 4th Holiday(Month, Day, Schedule Number)	R/W			word
1236H-1238H	The 5th Holiday(Month, Day, Schedule Number)	R/W			Word

1239H-123BH	The 6th Holiday(Month, Day, Schedule Number)	R/W			Word
123CH-123EH	The 7th Holiday(Month, Day, Schedule Number)	R/W			Word
123FH-1241H	The 8th Holiday(Month, Day, Schedule Number)	R/W			Word
1242H-1244H	The 9th Holiday(Month, Day, Schedule Number)	R/W			Word
1245H-1247H	The 10th Holiday(Month, Day, Schedule Number)	R/W			Word
1248H-124AH	The 11th Holiday(Month, Day, Schedule Number)	R/W			Word
124BH-124DH	The 12th Holiday(Month, Day, Schedule Number)	R/W			Word
124EH-1250H	The 13th Holiday(Month, Day, Schedule Number)	R/W			Word

1251H-1253H	The 14th Holiday(Month, Day, Schedule Number)	R/W			Word
1254H-1256H	The 15th Holiday(Month, Day, Schedule Number)	R/W			Word
1257H-1259H	The 16th Holiday(Month, Day, Schedule Number)	R/W			Word
125AH-125CH	The 17th Holiday(Month, Day, Schedule Number)	R/W			Word
125DH-125FH	The 18th Holiday(Month, Day, Schedule Number)	R/W			Word
1260H-1262H	The 19th Holiday(Month, Day, Schedule Number)	R/W			word
1263H-1265H	The 20th Holiday(Month, Day, Schedule Number)	R/W			Word
1266H-1268H	The 21st Holiday(Month, Day, Schedule Number)	R/W			Word

1269H-126BH	The 22nd Holiday(Month, Day, Schedule Number)	R/W			Word
126CH-126EH	The 23rd Holiday(Month, Day, Schedule Number)	R/W			Word
126FH-1271H	The 24th Holiday(Month, Day, Schedule Number)	R/W			Word
1272H-1274H	The 25th Holiday(Month, Day, Schedule Number)	R/W			Word
1275H-1277H	The 26th Holiday(Month, Day, Schedule Number)	R/W			Word
1278H-127AH	The 27th Holiday(Month, Day, Schedule Number)	R/W			Word
127BH-127DH	The 28th Holiday(Month, Day, Schedule Number)	R/W			Word
127EH-1280H	The 29th Holiday(Month, Day, Schedule Number)	R/W			Word

1281H-1283H	The 30th Holiday(Month, Day, Schedule Number)	R/W			Word
-------------	---	-----	--	--	------

Weekend

Bit7	Bit6	Bit5	Bit4	Bit3	Bit2	Bit1	Bit0
0	1: Work			0: Rest			
Reserved	Saturday	Friday	Thursday	Wednesday	Tuesday	Monday	Sunday

Tariff parameter error word 1(basic parameter)

Bit7	Bit6	Bit5	Bit4	Bit3	Bit2	Bit1	Bit0
1	1	1	1	1	1	1	1
Weekend Schedule Setting Error	Holiday Setting Error	Holiday Number Exceeds	Season Setting Error	Season Number Exceeds	Schedule Table Exceeds	Schedule Setting Error	Tariff Exceeds

Tariff parameter error word 1(basic parameter)

Bit7	Bit6	Bit5	Bit4	Bit3	Bit2	Bit1	Bit0
1	1	1	1	1	1	1	1
Schedule 8 Error	Schedule 7 Error	Schedule 6 Error	Schedule 5 Error	Schedule 4 Error	Schedule 3 Error	Schedule 2 Error	Schedule 1 Error

Trending Record Settings

1300H	Log1 #Registers # Sectors	R/W	#Registers: 0-117 # Sectors: 0-10	Word
1301H	Log1 Interval	R/W	0-65535	Word

1302H~1376H	Log1 register #1-#117 identifier	R/W	0-65535	Word
1377H~13B1H	Log1 register #1-#117 descriptors	R/W	High 4 bit: data type Low 4 bit: data length	Byte
13B2H	log mode selection	R/W	0: Mode 1 1: Mode 2 2: Mode 3	Word
13B3H	Starting Year/ Month	R/W		Word
13B4H	Starting Day/ Hour	R/W		Word
13B5H	Starting Minute/Second	R/W		Word
13B6H	Ending Year/ Month	R/W		Word
13B7H	Ending Day/ Hour	R/W		Word
13B8H	Ending Minute/ Second	R/W		Word
13B9H	Clear Trending Log	R/W	0: not clear 1: clear	Word
13C0H~1479H	Log2 setting		the same as Log1	
1480H~ 1539H	Log3 setting		the same as Log1	

The logging can be implemented by putting the desired parameter Modbus address in the register of Trending Record. Some parameters use 2 Modbus registers, so the descriptor is required. A descriptor represents how many Modbus registers a parameter uses.

For example, register 4102H and 4103H are configured as a specific record, the corresponding descriptor is 2, the software can display content as "Frequency"

Trending log setting includes: Log1 Setting, Log2 Setting, Log3 Setting.

1300H-13BFH (Log1)

13C0H-147FH (Log2)

1480H-153FH (Log3)

Range: each record uses 192 registers (384 bytes)

Trending record setting:

1300H – 1301H	1302H – 1376H	1377H – 13B1H	13B2H – 13B8H
Log Settings	Parameter Register Address	Register Property	Register Property

1. Log Settings

Register 1300H – 1301H

Size 2

Address	1300H		1301H	
Bytes	0(Low byte)	1(High byte)	2(Low byte)	3(High byte)
Parameter	Sector #	Register #	Logging time	

Register Number: The number of Modbus registers. Data range 0-117. The trending record size is Register Number x 2 + 12.

Sector Number: Each sector is 64 kB. Trending Log1, Log2, Log3 in total use 100 sectors, the range is 0-100. (The logging is disabled if the setting is set as 0)

Logging Interval: the time interval between two records. the unit is minute. The range is 0-1440. (when it is set as 0, logging will be disabled)

2. Parameter Address

Register: 1302H-1376H

Size: One parameter uses one, two or three Modbus register addresses, in total there are 117 addresses.

Modbus register address list, you can set the parameters that are recorded in the record set the trend, because some parameters, such as power and electricity, etc., takes up two Modbus address, to record these parameters need to use two Modbus address to characterize. Some parameter take up 3 Modbus address such as maximum demand happening time.

For example: Register 2000H and 2001H is set in the trend recorded in the register list, **the trends recorded in these registers record access frequency value**. Frequency Modbus addresses is 2000H and 2001H.

Note: when 117 registers are all fully assigned, be sure that no extra parameters will be assigned. For example, all parameter registers are energy, when all 117 registers are full, it leads to that the last energy only uses one Modbus address. The last value will be incorrect because every energy uses two Modbus addresses.

- Unused register should be set as 0000H or FFFFH.
- Each logging size is decided by the above register number

3. Register property:

Register: 1377H-13B1H

Size: one register uses one byte, in total there are 117 descriptors.(59 register addresses)
The descriptor indicates how many register number one parameter uses. It can be set as 1

or 2 or 3.

For example: If the first descriptor is 2, the second descriptor is 1, then the first two Modbus addresses belong to the first, the third Modbus address belongs to the second descriptor.

Note: From the above example can be seen between the register list and the descriptor is not one to one, a record register property may correspond to two recording parameter register address.

4. Logging mode setting

Logging mode as follows:

Mode 1: Interval setting time recording, recording full set sector, the records covering the trend originated.

Mode 2: within the set time, recording data, if within a set range record full set sector, to stop recording.

Mode 3: To set the start time to start recording data, records full set sector, the records covering the trend originated.

Register address 13B2H is the trend recording a mode setting register, 0-Log 1; 1-Log 2; 2-Log 3.

13B3H to 13B5H is to set the starting time of the trend recording, 13B6H to 13B8H is to set the trend recording ending time.

Register 13B3H-13B5H(Logging Timer starting time)

13B6H-13B8H(Logging Timer ending time)

Size 3

Byte	0	1	2	3	4	5
Parameter	Year	Month	Day	Hour	Minute	Second

Trending Log Status

Trending Log Status describes the current status of each record.

Address	Parameter	Property	Range	Data Type
3C00H~3C01H	Logging 1 Max record	R	0-468100	dword
3C02H~3C03H	Logging 1 Used Record	R	0-468100	dword
3C04H	Logging 1 Record Size	R	14-246	word
3C05H	Reserved			
3C06H~3C08H	Logging 1 First Record Time	R		word
3C09H~3C0bH	Logging 1 Last Record Time	R		word
3D00H~3D01H	Logging 2 Used Record	R	0-468100	dword
3D02H~3D03H	Logging 2 Record Size	R	0-468100	dword
3D04H	Reserved	R	14-246	word
3D05H	Logging 2 First Record Time	R		
3D06H~3D08H	Logging 2 Last Record Time	R		word
3D09H~3D0bH	Logging 2 Used Record	R		word

3E00H~3E01H	Logging 3 Used Record	R	0-468100	dword
3E02H~3E03H	Logging 3 Record Size	R	0-468100	dword
3E04H	Reserved	R	14-246	word
3E05H	Logging 3 First Record Time	R		
3E06H~3E08H	Logging 3 Last Record Time	R		word
3E09H~3E0bH	Logging 3 Used Record	R		word

Max Record: the maximum number of records the log can record based on the given Record Size and Sector Number.

Used Record: The record number of the log, when the log is full, it should equal Max Record.

When the log is reset, User Record will be changed to 0.

Record Size: Each record size in the log, including timestamp.

The trending record format is Record Number(4bytes) + Timestamp(6bytes) + [Data1-DataN] (2Nbytes) + CRC(2bytes).

Record Starting Time: First Record, the earliest record time.

Record Ending Time: Last Record, the latest record time.

Trending Record Retrieve

Trending Record can be divided into two parts: File Header and Main Window. File Header is used to finalize the contents displayed in Main Window. Main Window is a sliding window representing all the records. 3 trending records have one address.

Register 3B00H-3B03H

Size 4

Address	Parameter	Property	Format	Description
3B00H	Record Type	R/W	Nnnnnnnn	Record Type
			ssssssss	Reserved
3B01H	Window Record Number,Status	R/W	wwwwwwwww	status
			nnnnnnnn	Window Record Number
3B02H~3B03H	Window Status + Record Offset	R/W		
3B04H~3B7eH	Window	R		

Record Type: which record will be read

- 0 — Log 1
- 1 — Log 2
- 2 — Log 3

Record Number: the record number each window displays. Please note this Record Number cannot exceed the window size. This setting tells AcuRev 2000 how many records are saved in Main Window. Window size bytes equal window record multiplied with Record Size.

For example, a record size is 50, the window size should be $246/50 = 4$.

Status: Window Status indicates the data status of the current window. It may exceed the time delay 1 second when AcuRev 2000 is preparing for a one window size data. This byte represents the data effectiveness, if the window records are not effective, the data will be ignored. In addition, it takes time to erase the memory. The memory erasing status can be represented by this byte. If Window Status is read only, all writing operations are disabled.

bH Window Status effective

FFH Window Status not effective

aaH Data Log erasing in operation

bbH Data Log erasing not in operation

Offset: this parameter is configurable. In order to read all the records of one log, users can just modify this offset value. When the data is retrieved, the first data is locked, so offset 0 is always pointed at the first data.

Window: a window is where to store the data, the window is read only. Please note, the data number in the window is an integer.

Retrieve Note

As the trend recording record full case, when using trend record mode 1 and mode 3 will erase the earliest record of a sector of data in order to continue to record. When reading the whole trend recording so try to avoid in read write full set by sector is, whether going to write full set by sector depends on whether has with the record number close to the maximum number of records. **If set to be filled with the situation of the sector continue to read, you should read before reading a window about the current record number of records that have been used to compare this with the number of records that have been are down from decreases with the number of records by dividing the maximum number of records record number of sectors, if this offset is less than the maximum number of records divided by the number of sectors records, then the number of records to be read should subtract this number from . The earliest record data of one sector data has been erased irreversible. If at this time if the time offset is greater than the maximum number of records divided by the number of sectors records, then the offset should be unified after subtracting this number. To avoid these problems, we recommend that users use as much as possible before the trend for reading demerit record.**

For example, log 1 uses 3 sectors, each sector saves 448 records, in total there will be 1344 records. When the user retrieves the data when 1340 records are used, the first sector of log 1 will be erased without being retrieved.

Data Retrieve Example

- The example is based on log 1.
- The logging content is Channel 1 Active Power, Channel 2 Active Power and Channel 3 Active Power (12 bytes), the logging interval is 1 minute, sector number is 10, register number is 6, using log 1.
- The Offset is 0.
- There are no new records logged while retrieving.

a) Setup Log 1:

1. Set Tenant 1 Power, Tenant 2 Power, Tenant 3 Power into this log. Since each parameter uses two Modbus registers, set 0x2102, 0x2103, 0x210e, 0x210f, 0x211a, 0x211b to 0x1302, 0x1303, 0x1304, 0x1305, 0x1306 and 0x1307. The descriptor is 2, so at the same time set 0x0202, 0x0200 to 0x1377, 0x1378
2. The register number is 6, it uses 10 sectors. So set 0x060A to 0x1300
3. The logging interval is 1 minute, set 0x0001 to 0x1301.
4. Log 1, set 0 to 0x13b9, the default is the log 1

b) Data Log Retrieve

The following describes how to retrieve from the earliest record to the latest record.

1. Calculate the max record number a window holds. The max record number = $246 / \text{Record Size}$. In this example, $246 / 24 = 10$.

2. Set the max record number and Offset to the meter. Initially the Offset is 0. In this example, set 0x0A0B and 0x0000 to 0x3B01 and 0x3B02.
3. Read the Window Status from 0x3B01, if the status says 0xFF, then go to step 2 to set max record number and Offset again. If the status says 0x0B, the content of the window will be read.
4. Read the window content and calculate the next record offset. The next record offset is the last record offset plus the max record number per window. After completing, set the new offset to 0x3B02. Then repeat step 3 until all the records are retrieved.

Basic Measurement

AcuRev 2010 only takes power related measurements. The format is floating point. Each parameter uses 4 bytes, high bytes are followed by low bytes. Function Code: 03. Read only.

Address	Parameter	Property	Alarm parameter label	Default	Data Type
2000H-2001H	F	R	0		float
2002H-2003H	U1	R	1		float
2004-2005H	U2	R	2		float
2006-2007H	U3	R	3		float
2008-2009H	Uavg	R	4		float
200AH-200BH	U12	R	5		float
200CH-200DH	U23	R	6		float
200EH-200FH	U31	R	7		float
2010H-2011H	Ulavg	R	8		float
2012H-2013H	IL1(Phase A inline current)	R	9		float
2014H-2015H	IL2(Phase B inline current)	R	10		float

2016H-2017H	IL3(Phase C inline current)	R	11		float
2018H-2019H	Iavg(Average Current)	R	12		float
201AH-201BH	Pin-s inline system real power	R	13		float
201CH-201DH	Qin-s inline system reactive power	R	14		float
201EH-201FH	Sin-s inline system apparent power	R	15		float
2020H-2021H	PFin-s inline system power factor	R	16		float
2022H-2023H	Inline System Load Nature	R			float
2024H-2025H	Pin-A inline Phase A real power	R	17		float
2026H-2027H	Pin-B inline Phase B real power	R	18		float
2028H-2029H	Pin-C inline Phase C real power	R	19		float
202AH-202BH	Qin-A inline Phase A reactive power	R	20		float
202CH-202DH	Qin-B inline Phase B reactive power	R	21		float
202EH-202FH	Qin-C inline Phase C reactive power	R	22		float
2030H-2031H	Sin-A inline A apparent power	R	23		float
2032H-2033H	Sin-B inline B apparent power	R	24		float
2034H-2035H	Sin-C inline C apparent power	R	25		float

2036H-2037H	PFin-A inline A power factor	R	26		float
2038H-2039H	PFin-B inline B power factor	R	27		float
203AH-203BH	PFin-C inline C power factor	R	28		float
203CH-203DH	A inline load nature	R			float
203EH-203FH	B inline load nature	R			float
2040H-2041H	C inline load nature	R			float
2100H-2101H	I1(Channel 1 Current)	R	29		float
2102H-2103H	P1(Channel 1 Real power)	R	30		float
2104H-2105H	Q1(Channel 1 Reactive power)	R	31		float
2106H-2107H	S1(Channel 1 Apparent Power)	R	32		float
2108H-2109	PF1(Channel 1 Power Factor)	R	33		float
210AH-210B	Load Nature 1(Channel 1 Load Nature)	R			float
210CH-2117H	Channel 2 Measurement	R	The same as Channel 1 34-38		float
2118H-2123H	Channel 3 Measurement	R	The same as Channel 1 39-43		float
2124H-212FH	Channel 4 Measurement	R	The same as Channel 1 44-48		float
2130H-213BH	Channel 5 Measurement	R	The same as Channel 1 49-53		float
213CH-2147H	Channel 6 Measurement	R	The same as Channel 1 54-58		float

2148H-2153H	Channel 7 Measurement	R	The same as Channel 1 59-63		float
2154H-215FH	Channel 8 Measurement	R	The same as Channel 1 64-68		float
2160H-216BH	Channel 9 Measurement	R	The same as Channel 1 69-73		float
216CH-2177H	Channel 10 Measurement	R	The same as Channel 1 74-78		float
2178H-2183H	Channel 11 Measurement	R	The same as Channel 1 79-83		float
2184H-218FH	Channel 12 Measurement	R	The same as Channel 1 84-88		float
2190H-219BH	Channel 13 Measurement	R	The same as Channel 1 89-93		float
219CH-21A7H	Channel 14 Measurement	R	The same as Channel 1 94-98		float
21A8H-21B3H	Channel 15 Measurement	R	The same as Channel 1 99-103		float
21B4H-21BFH	Channel 16 Measurement	R	The same as Channel 1 104-108		float
21C0H-21CBH	Channel 17 Measurement	R	The same as Channel 1 109-113		float
21CCH-21D7H	Channel 18 Measurement	R	The same as Channel 1 114-118		float
21D8H-21D9H	Ps1(Channel 1 3-phase 4-line/single- phase 3-line total active power)	R	119		float
21DAH-21DBH	Qs1(Channel 1 3-phase 4-line/single- phase 4-line total reactive power)	R	120		float

21DCH-21DDH	Ss1(Channel 1 3-phase 4-line/single-phase 3-line total apparent power)	R	121		float
21DEH-21DFH	PFs1(Channel 1 3-phase 4-line/single-phase 3-line total power factor)	R	122		float
21E0H-21E1H	Nature of the load (Channel 1 3-phase 4-line/single-phase 3-line nature of the load)	R			float
21E2H-21EBH	Channel 2 Measurement	R	Same as to Channel 1 3-phase 4-line / single-phase 3-line 123-126		float
21ECH-21F5H	Channel 3 Measurement	R	Same as to Channel 1 3-phase 4-line / single-phase 3-line 127-130		float
21F6H-21FFH	Channel 4 Measurement	R	Same as to Channel 1 3-phase 4-line /single-phase 3-line131-134		float
2200H-2209H	Channel 5 Measurement	R	Same as to Channel 1 3-phase 4-line / single-phase 3-line 135-138		float
220AH-2213H	Channel 6 Measurement	R	Same as to Channel 1 3-phase 4-line / single-phase 3-line 139-142		float

Energy

The decimal place for energy is 1, the real value is communication value divided by 10. The unit is kWh. Real-time energy and this month TOU energy is editable, but the prior month TOU energy cannot be edited. The data type is double word, each parameter uses two register address, 4 bytes. High bytes are followed by low bytes. Function Code 03 to read, Function Code 10 to write.

Real Time Energy

Address(H)	Parameter	Property	Range	Default	Data Type
Inline real time energy					
2500H-2501H	Epin-A inline Phase A real time energy	R/W			dword
2502H-2503H	Epin-B inline Phase B real time energy	R/W			dword
2504H-2505H	Epin-C inline Phase C real time energy	R/W			dword
2506H-2507H	Epin-S inline system real time energy	R/W			dword
Channel 1-18 single-phase 3+Channel 1-6 3-phase 4-line/single-phase 3-line real-time energy					
2508H-2509H	Channel 1 real-time energy	R/W			dword
250AH-250BH	Channel 2 real-time energy	R/W			dword

250CH-250DH	Channel 3 real-time energy	R/W			dword
250EH-250FH	Channel 4 real-time energy	R/W			dword
2510H-2511H	Channel 5 real-time energy	R/W			dword
2512H-2513H	Channel 6 real-time energy	R/W			dword
2514H-2515H	Channel 7 real-time energy	R/W			dword
2516H-2517H	Channel 8 real-time energy	R/W			dword
2518H-2519H	Channel 9 real-time energy	R/W			dword
251AH-251BH	Channel 10 real-time energy	R/W			dword
251CH-251DH	Channel 11 real-time energy	R/W			dword
251EH-251FH	Channel 12 real-time energy	R/W			dword
2520H-2521H	Channel 13 real-time energy	R/W			dword
2522H-2523H	Channel 14 real-time energy	R/W			dword
2524H-2525H	Channel 15 real-time energy	R/W			dword
2526H-2527H	Channel 16 real-time energy	R/W			dword
2528H-2529H	Channel 17 real-time energy	R/W			dword
252AH-252BH	Channel 18 real-time energy	R/W			dword

252CH-252DH	Channel 1 3-phase 4-line / single- phase 3-line real- time system active power energy	R/W			dwod
252EH-252FH	Channel 2 3-phase 4-line / single- phase 3-line real- time system active power energy	R/W			dwod
2530H-2531H	Channel3 3-phase 4-line / single- phase 3-line real- time system active power energy	R/W			dwod
2532H-2533H	Channel 4 3-phase 4-line / single- phase 3-line real- time system active power energy	R/W			dwod
2534H-2535H	Channel 5 3-phase 4-line / single- phase 3-line real- time system active power energy	R/W			dwod
2536H-2537H	Channel 6 3-phase 4-line / single- phase 3-line real- time system active power energy	R/W			dwod

TOU Energy – This Month TOU Energy

Address	Parameter	Property	Range	Default	Data Type
Inline this month TOU energy					
2600H-2601H	Epin-S inline system this month TOU energy	R/W			dwod
2602H-2603H	Epin-S inline system this month TOU energy (tariff 1)	R/W			dwod
2604H-2605H	Epin-S inline system this month TOU energy (tariff 2)	R/W			dwod
2606H-2607H	Epin-S inline system this month TOU energy (tariff 3)	R/W			dwod
2608H-2609H	Epin-S inline system this month TOU energy (tariff 4)	R/W			dwod
260AH-260BH	Epin-A inline Phase A this month TOU energy (total)	R/W			dwod
260CH-260DH	Epin-A inline Phase A this month TOU energy (tariff 1)	R/W			dwod
260EH-260FH	Epin-A inline Phase A this month TOU energy (tariff 2)	R/W			dwod
2610H-2611H	Epin-A inline Phase A this month TOU energy (tariff 3)	R/W			dwod
2612H-2613H	Epin-A inline Phase A this month TOU energy (tariff 4)	R/W			dwod

2614H-2615H	Epin-B inline Phase B this month TOU energy(total)	R/W			dwod
2616H-2617H	Epin-B inline Phase B this month TOU energy (tariff 1)	R/W			dwod
2618H-2619H	Epin-B inline Phase B this month TOU energy (tariff 2)	R/W			dwod
261AH-261BH	Epin-B inline Phase B this month TOU energy (tariff 3)	R/W			dwod
261CH-261DH	Epin-B inline Phase B this month TOU energy (tariff 4)	R/W			dwod
261EH-261FH	Epin-C inline Phase C this month TOU energy(total)	R/W			dwod
2620H-2626H	Epin-C inline Phase C this month TOU energy (tariff 1)	R/W			dwod
2622H-2623H	Epin-C inline Phase C this month TOU energy (tariff 2)	R/W			dwod
2624H-2625H	Epin-C inline Phase C this month TOU energy (tariff 3)	R/W			dwod
2626H-2627H	Epin-C inline Phase C this month TOU energy (tariff 4)	R/W			dwod
Channel 1-18 single-phase 3+Channel 1-6 3-phase 4-line/single-phase 3-line this month TOU energy					

2628H-2629H	Channel 1 this month TOU energy (total)	R/W			dwod
262AH-262BH	Channel 1 this month TOU energy (Tariff 1)	R/W			dwod
262CH-262DH	Channel 1 this month TOU energy (Tariff 2)	R/W			dwod
262EH-262FH	Channel1 this month TOU energy (Tariff 3)	R/W			dwod
2630H-2631H	Channel1 this month TOU energy (Tariff 4)	R/W			dwod
2632H-263BH	Channel 2 this month TOU energy –The same as Channel 1	R/W			dwod
263CH-2645H	Channel 3 this month TOU energy –The same as Channel 1	R/W			dwod
2646H-264FH	Channel 4 this month TOU energy –The same as Channel 1	R/W			dwod
2650H-2659H	Channel 5 this month TOU energy –The same as Channel 1	R/W			dwod
265AH-2663H	Channel 6 this month TOU energy –The same as Channel 1	R/W			dwod
2664H-266DH	Channel 7 this month TOU energy –The same as Channel 1	R/W			dwod
266EH-2677H	Channel 8 this month TOU energy –The same as Channel 1	R/W			dwod

2678H-2681H	Channel 9 this month TOU energy –The same as Channel 2	R/W			dwod
2682H-268BH	Channel 10 this month TOU energy –The same as Channel 1	R/W			dwod
268CH-2695H	Channel 11 this month TOU energy –The same as Channel	R/W			dwod
2696H-269FH	Channel 12 this month TOU energy –The same as Channel 1	R/W			dwod
26A0H-26A9H	Channel 13 this month TOU energy –The same as Channel 1	R/W			dwod
26AAH-26B3H	Channel 14 this month TOU energy –The same as Channel 1	R/W			dwod
26B4H-26BDH	Channel 15 this month TOU energy –The same as Channel 1	R/W			dwod
26BEH-26C7H	Channel 16 this month TOU energy –The same as Channel 1	R/W			dwod
26C8H-26D1H	Channel 17 this month TOU energy –The same as Channel 1	R/W			dwod
26D2H-26DBH	Channel 18 this month TOU energy –The same as Channel 1	R/W			dwod

26DCH- 26DDH	Channel 1 3-phase 4-line / single-phase 3-line system this month TOU energy(total)	R/W			dwod
26DEH- 26DFH	Channel 1 3-phase 4-line / single-phase 3-line system this month TOU energy(tariff 1)	R/W			dwod
26E0H- 26E1H	Channel 1 3-phase 4-line / single-phase 3-line system this month TOU energy(tariff 2)	R/W			dwod
26E2H- 26E3H	Channel 1 3-phase 4-line / single-phase 3-line system this month TOU energy(tariff 3)	R/W			dwod
26E4H- 26E5H	Channel 1 3-phase 4-line / single-phase 3-line system this month TOU energy(tariff 4)	R/W			dwod
26E6H- 26EFH	Channel 2 3-phase 4-line/ single-phase 3-line data- The same as to Channel 1 3-phase 4-line / single-phase 3-line data	R/W			dwod
26F0H- 26F9H	Channel 3 3-phase 4-line/ single-phase 3-line data- The same as to Channel 1 3-phase 4-line / single-phase 3-line data	R/W			dwod

26FAH-2703H	Channel 4 3-phase 4-line/ single-phase 3-line data- The same as to Channel 1 3-phase 4-line / single- phase 3-line data	R/W			dwod
2704H-270DH	Channel 5 3-phase 4-line/ single-phase 3-line data- The same as to Channel 1 3-phase 4-line / single- phase 3-line data	R/W			dwod
270EH-2717H	Channel 6 3-phase 4-line/ single-phase 3-line data- The same as to Channel 1 3-phase 4-line / single- phase 3-line data	R/W			dwod

TOU Energy – Prior month TOU energy

Address(H)	Parameter	Property	Range	Default	Data Type
Inline prior month TOU energy					
2900H-2901H	Epin-S inline system prior month TOU energy(total)	R			dwod
2902H-2903H	Epin-S inline system prior month TOU energy (tariff 1)	R			dwod
2904H-2905H	Epin-S inline system prior month TOU energy (tariff 2)	R			dwod

2906H-2907H	Epin-S inline system prior month TOU energy (tariff 3)	R			dwod
2908H-2909H	Epin-S inline system prior month TOU energy (tariff 4)	R			dwod
290AH-290BH	Epin-A inline Phase A prior month TOU energy (total)	R			dwod
290CH-290DH	Epin-A inline Phase A prior month TOU energy (tariff 1)	R			dwod
290EH-290FH	Epin-A inline Phase A prior month TOU energy (tariff 2)	R			dwod
2910H-2911H	Epin-A inline Phase A prior month TOU energy (tariff 3)	R			dwod
2912H-2913H	Epin-A inline Phase A prior month TOU energy (tariff 4)	R			dwod
2914H-2915H	Epin-B inline Phase B prior month TOU energy (total)	R			dwod
2916H-2917H	Epin-B inline Phase B prior month TOU energy (tariff 1)	R			dwod
2918H-2919H	Epin-B inline Phase B prior month TOU energy (tariff 2)	R			dwod

291AH-291BH	Epin-B inline Phase B prior month TOU energy (tariff 3)	R			dwod
291CH-291DH	Epin-B inline Phase B prior month TOU energy (tariff 4)	R			dwod
291EH-291FH	Epin-C inline Phase C prior month TOU energy (total)	R			dwod
2920H-2921H	Epin-C inline Phase C prior month TOU energy (tariff 1)	R			dwod
2922H-2923H	Epin-C inline Phase C prior month TOU energy (tariff 2)	R			dwod
2924H-2925H	Epin-C inline Phase C prior month TOU energy (tariff 3)	R			dwod
2926H-2927H	Epin-C inline Phase C prior month TOU energy (tariff 4)	R			dwod
Channel 1-18 single-phase 3+Channel 1-6 3-phase 4-line/single-phase 3-line prior month TOU energy					
2928H-2929H	Channel 1 prior month TOU energy (total)	R			dwod
292AH-292BH	Channel 1 prior month TOU energy (Tariff 1)	R			dwod
292CH-292DH	Channel 1 prior month TOU energy (Tariff 2)	R			dwod

292EH-292FH	Channel 1 prior month TOU energy (Tariff 3)	R			dwod
2930H-2931H	Channel 1 prior month TOU energy (Tariff 4)	R			dwod
2932H-293BH	Channel 2 prior month TOU energy –The same as Channel 1	R			dwod
293CH-2945H	Channel 3 prior month TOU energy –The same as Channel 1	R			dwod
2946H-294FH	Channel 4 prior month TOU energy –The same as Channel 1	R			dwod
2950H-2959H	Channel 5 prior month TOU energy –The same as Channel 1	R			dwod
295AH-2963H	Channel 6 prior month TOU energy –The same as Channel 1	R			dwod
2964H-296DH	Channel 7 prior month TOU energy –The same as Channel 1	R			dwod

296EH-2977H	Channel 8 prior month TOU energy -The same as Channel 1	R			dwod
2978H-2981H	Channel 9 prior month TOU energy -The same as Channel 1	R			dwod
2982H-298BH	Channel 10 prior month TOU energy -The same as Channel 1	R			dwod
298CH-2995H	Channel 11 prior month TOU energy -The same as Channel 1	R			dwod
2996H-299FH	Channel 12 prior month TOU energy -The same as Channel 1	R			dwod
29A0H-29A9H	Channel 13 prior month TOU energy -The same as Channel 1	R			dwod
29AAH-29B3H	Channel 14 prior month TOU energy -The same as Channel 1	R			dwod
29B4H-29BDH	Channel 15 prior month TOU energy -The same as Channel 1	R			dwod

29BEH-29C7H	Channel 16 prior month TOU energy -The same as Channel 1	R			dwod
29C8H-29D1H	Channel 17 prior month TOU energy -The same as Channel 1	R			dwod
29D2H-29DBH	Channel 18 prior month TOU energy -The same as Channel 1	R			dwod
29DCH-29DDH	Channel 1 3-phase 4-line/single-phase 3-line prior month system TOU energy(Total)	R			dwod
29DEH-29DFH	Channel 1 3-phase 4-line/single-phase 3-line prior month system TOU energy(Tariff 1)	R			dwod
29E0H-29E1H	Channel 1 3-phase 4-line/single-phase 3-line prior month system TOU energy(Tariff 2)	R			dwod
29E2H-29E3H	Channel 1 3-phase 4-line/single-phase 3-line prior month system TOU energy(Tariff 3)	R			dwod

29E4H-29E5H	Channel 1 3-phase 4-line/single-phase 3-line prior month system TOU energy(Tariff 4)	R			dwod
29E6H-29EFH	Channel 2 3-phase 4-line/single-phase 3-line data-The same as to Channel 1 3-phase 4-line / single-phase 3-line data	R			dwod
29F0H-29F9H	Channel 3 3-phase 4-line/single-phase 3-line data-The same as to Channel 1 3-phase 4-line / single-phase 3-line data	R			dwod
29FAH-2A03H	Channel 4 3-phase 4-line/single-phase 3-line data-The same as to Channel 1 3-phase 4-line / single-phase 3-line data	R			dwod
2A04H-2A0DH	Channel 5 3-phase 4-line/single-phase 3-line data-The same as to Channel 1 3-phase 4-line / single-phase 3-line data	R			dwod

2A0EH-2A17H	Channel 6 3-phase 4-line/single-phase 3-line data-The same as to Channel 1 3-phase 4-line / single-phase 3-line data	R			dwod
-------------	--	---	--	--	------

Reactive Energy

Address	Parameter	Property	Range	Default	Data Type
Inline Reactive Power Energy					
2B00H-2B01H	Eqin-A inline Phase A Reactive Power Energy	R/W			dwod
2B02H-2B03H	Eqin-B inline Phase B Reactive Power Energy	R/W			dwod
2B04H-2B05H	Eqin-C inline Phase C Reactive Power Energy	R/W			dwod
2B06H-2B07H	Eqin-S inline system Reactive Energy	R/W			dwod
Channel 1-18 single-phase 3+Channel 1-6 3-phase 4-line/single-phase 3-line reactive power energy					
2B08H-2B2BH	Tenant 1-18 real-time Reactive Power Energy	R/W			dwod
2B2CH-2B2DH	Tenant 1 real-time system Reactive Power Energy	R/W			dwod

2B2EH- 2B37H	Tenant 2-6 Reactive Power Energy data	R/W			
-----------------	--	-----	--	--	--

Apparent Energy

Address	Parameter	Property	Range	Default	Data Type
Inline Apparent Energy					
2B38H- 2B39H	Eqin-A inline Phase A Apparent Energy	R/W			dwod
2B3AH- 2B3BH	Esin-B inline Phase B Apparent Energy	R/W			dwod
2B3CH- 2B3DH	Esin-C inline Phase C Apparent Energy	R/W			dwod
2B3EH- 2B3FH	Esin-S inline system Apparent Energy	R/W			dwod
Channel 1-18 single-phase 3+Channel 1-6 3-phase 4-line/single-phase 3-line prior month apparent energy					
2B40H- 2B63H	Tenant 1-18 real-time Apparent Energy	R/W			dwod
2B64H- 2B65H	Tenant 1 real-time system Apparent Energy	R/W			dwod
2B66H- 2B6FH	Tenant 2-6 Apparent Energy data	R/W			

Demand

Address	Parameter	Property	Remark	Alarm parameter label	Data Type
Inline Demand					

2D00H-2D01H	Pin-s-dema inline system demand	R		143	float
2D02H-2D03H	PinS inline system power demand prediction	R		144	float
2D04H-2D05H	Pin-s-dema-max inline system demand peak	R			float
2D06H-2D08H	Pin-s-time inline system demand peak times	R	Year, Month, Day, Hour, Minute, Second		word
2D09H-2D0AH	Qin-s-dema inline system reactive power demand	R		145	float
2D0BH-2D0CH	QinS inline system reactive power demand prediction	R		146	float
2D0DH-2D0EH	Qin-s-dema-max inline system reactive power demand peak	R			float
2D0FH-2D11H	Qin-s-time inline system reactive power demand peak times	R	Year, Month, Day, Hour, Minute, Second		word
2D12H-2D13H	Sin-s-dema inline system apparent demand	R		147	float
2D14H-2D15H	SinS inline system apparent demand prediction	R		148	float

2D16H- 2D17H	Sin-s-dema-max inline system apparent demand peak	R			float
2D18H- 2D1AH	Sin-s-time inline system apparent demand peak times	R	Year, Month, Day, Hour, Minute, Second		word
2D1BH- 2D1CH	IL1-dema(Phase A inline current demand)	R		149	float
2D1DH- 2D1EH	Phase A inline current demand prediction			150	Float
2D1FH- 2D20H	IL1-dema- max(Phase A inline max current demand)	R			float
2D21H- 2D23H	IL1-time(Phase A inline max current demand occurrence)	R	Year, Month, Day, Hour, Minute, Second		word
2D24H- 2D25H	Pin-A-dema inline phase A power demand	R		151	float
2D26H- 2D27H	PinA inline phase A power demand prediction	R		152	float
2D28H- 2D29H	Pin-A-dema-max inline phase A power demand peak	R			float
2D2AH- 2D2CH	Pin-A-time inline phase A power demand peak times	R	Year, Month, Day, Hour, Minute, Second		word

2D2DH- 2D2EH	Qin-A-dema inline phase A reactive power demand	R		153	float
2D2FH- 2D30H	QinA inline phase A reactive power demand prediction	R		154	float
2D31H- 2D32H	Qin-A-dema- max inline phase A reactive power demand peak	R			float
2D33H- 2D35H	Qin-A-time inline phase A reactive power demand peak times	R	Year, Month, Day, Hour, Minute, Second		word
2D36H- 2D37H	Sin-A-dema inline phase A apparent demand	R		155	float
2D38H- 2D39H	SinA inline phase A apparent demand prediction	R		156	float
2D3AH- 2D3BH	Sin-A-dema-max inline phase A apparent demand peak	R			float
2D3CH- 2D3EH	Sin-A-time inline phase A apparent demand peak times	R	Year, Month, Day, Hour, Minute, Second		word
2D3FH- 2D62H	Inline phase B demand data				Same as phase A demand 157-164
2D63H- 2D86H	Inline phase C demand data				Same as phase A demand 165-172

2D87H-2DAAH	Channel 1 demand data	R		Same as phase A demand 173-180	
2DABH-2DCEH	Channel 2 demand data	R		Same as phase A demand 181-188	
2DCFH-2DF2H	Channel 3 demand data	R		Same as phase A demand 189-196	
2DF3H-2E16H	Channel 4 demand data	R		Same as phase A demand 197-204	
2E17H-2E3AH	Channel 5 demand data	R		Same as phase A demand 205-212	
2E3BH-2E5EH	Channel 6 demand data	R		Same as phase A demand 213-220	
2E5FH-2E82H	Channel 7 demand data	R		Same as phase A demand 221-228	
2E83H-2EA6H	Channel 8 demand data	R		Same as phase A demand 229-236	
2EA7H-2ECAH	Channel 9 demand data	R		Same as phase A demand 237-244	
2ECBH-2EEEH	Channel 10 demand data	R		Same as phase A demand 245-252	
2EEFH-2F12H	Channel 11 demand data	R		Same as phase A demand 253-260	
2F13H-2F36H	Channel 12 demand data	R		Same as phase A demand 261-268	
2F37H-2F5AH	Channel 13 demand data	R		Same as phase A demand 269-276	
2F5BH-2F7EH	Channel 14 demand data	R		Same as phase A demand 277-284	
2F7FH-2FA2H	Channel 15 demand data	R		Same as phase A demand 285-292	
2FA3H-2FC6H	Channel 16 demand data	R		Same as phase A demand 293-300	

2FC7H-2FEAH	Channel 17 demand data	R		Same as phase A demand 301-308	
2FEBH-300EH	Channel 18 demand data	R		Same as phase A demand 309-316	
300FH-3029H	Channel 1 3-phase 4-line/single-phase 3-line total demand	R		The same as to inline system demand(active demand, reactive power demand, apparent demand) 317-322	
302AH-3044H	Channel 2 3-phase 4-line/single-phase 3-line total demand	R		The same as to Channel 1 3-phase 4-line / single-phase 3-line 323-328	
3045H-305FH	Channel 3 3-phase 4-line/single-phase 3-line total demand	R		The same as to Channel 1 3-phase 4-line / single-phase 3-line 329-334	
3060H-307AH	Channel 4 3-phase 4-line/single-phase 3-line total demand	R		The same as to Channel 1 3-phase 4-line / single-phase 3-line 335-240	
307BH-3095H	Channel 5 3-phase 4-line/single-phase 3-line total demand	R		The same as to Channel 1 3-phase 4-line / single-phase 3-line 341-346	
3096H-30B0H	Channel 6 3-phase 4-line/single-phase 3-line total demand	R		The same as to Channel 1 3-phase 4-line / single-phase 3-line 347-352	

Energy Quality

The Power Quality parameters include Unbalance Factor, Total Harmonic Distortion, Crest-Factor Current K-Crest, Telephone interference factor and 2nd-31st harmonic data. 2010 does not measure power quality parameters. The power quality parameter data type is Integer. Each parameter uses 4 bytes (high bytes followed by low bytes).

Function Code 03: read.

There is Corresponding relationship between communication and actual values

Unbalance: $Unbl = (Rx/1000) \times 100\%$

Total harmonic distortion: $THD = (RX/10000) \times 100\%$

The harmonic distortion: $HDn = (RX/10000) \times 100\%$

Odd harmonic distortion: $HDo = (RX/10000) \times 100\%$

Even harmonic distortion: $HDe = (RX/10000) \times 100\%$

Crest Factor: $CF = RX/1000$

K-Factor: $KF = Rx/10$

Telephone interference factor: $THFF = (RX/10000) \times 100\%$

Rx Communications value

Address	Parameter	Property	Range	Default	Data Type
Inline Energy Quality					
3200H	Voltage Unbalance Factor	R			word
3201H	U1 or U12 THD-U1	R			word
3202H	U2 or U23 THD-U2	R			word

3203H	U3 or U31 THD-U3	R		word
3204H	Voltage THD average	R		word
3205H	U1 or U12 2nd harmonic	R		word
3206H	U1 or U12 3rd harmonic	R		word
.....	R		word
3222H	U1 or U12 31st harmonic	R		word
3223H	U2 or U23 2nd harmonic	R		word
3229H	U2 or U23 3rd harmonic	R		word
.....	R		word
3240H	U2 or U23 31st harmonic	R		word
3241H	U3 or U31 2nd harmonic	R		word
3242H	U3 or U31 3rd harmonic	R		word
.....	R		word
325EH	U3 or U31 31st harmonic	R		word
325FH	Current Unbalance Factor	R		Word
3260H	U1 Odd harmonic distortion	R		Word
3261H	U1 Even harmonic distortion	R		Word
3262H	U1 crest factor	R		Word

3263H	U1 Telephone harmonic form factor	R			Word
3264H	U2 Odd harmonic distortion	R			Word
3265H	U2 Even harmonic distortion	R			Word
3266H	U2 crest factor	R			Word
3267H	U2 Telephone harmonic form factor	R			Word
3268H	U3 Odd harmonic distortion	R			Word
3269H	U3 Even harmonic distortion	R			Word
326AH	U3 crest factor	R			Word
326BH	U3 Telephone harmonic form factor	R			Word
32A0H	Channel 1 Current Odd harmonic distortion	R			Word
32A1H	Channel 1 Current Even harmonic distortion	R			Word
32A2H	Channel 1 Current K-Factor	R			Word
32A3H	Channel 2 Current Odd harmonic distortion	R			Word
32A4H	Channel 2 Current Even harmonic distortion	R			Word
32A5H	Channel 2 Current K-Factor	R			Word
32A6H	Channel 3 Current Odd harmonic distortion	R			Word

32A7H	Channel 3 Current Even harmonic distortion	R		Word
32A8H	Channel 3 Current K-Factor	R		Word
32A9H	Channel 4 Current Odd harmonic distortion	R		Word
32AAH	Channel 4 Current Even harmonic distortion	R		Word
32ABH	Channel 4 Current K-Factor	R		Word
32ACH	Channel 5 Current Odd harmonic distortion	R		Word
32ADH	Channel 5 Current Even harmonic distortion	R		Word
32AEH	Channel 5 Current K-Factor	R		Word
32AFH	Channel 6 Current Odd harmonic distortion	R		Word
32B0H	Channel 6 Current Even harmonic distortion	R		Word
32B1H	Channel 6 Current K-Factor	R		Word
32B2H	Channel 7 Current Odd harmonic distortion	R		Word
32B3H	Channel 7 Current Even harmonic distortion	R		Word
32B4H	Channel 7 Current K-Factor	R		Word
32B5H	Channel 8 Current Odd harmonic distortion	R		Word
32B6H	Channel 8 Current Even harmonic distortion	R		Word

32B7H	Channel 8 Current K-Factor	R			Word
32B8H	Channel 9 Current Odd harmonic distortion	R			Word
32B9H	Channel 9 Current Even harmonic distortion	R			Word
32BAH	Channel 9 Current K-Factor	R			Word
32BBH	Channel 10 Current Odd harmonic distortion	R			Word
32BCH	Channel 10 Current Even harmonic distortion	R			Word
32BDH	Channel 10 Current K-Factor	R			Word
32BEH	Channel 11 Current Odd harmonic distortion	R			Word
32BFH	Channel 11 Current Even harmonic distortion	R			Word
32C0H	Channel 11 Current K-Factor	R			Word
32C1H	Channel 12 Current Odd harmonic distortion	R			Word
32C2H	Channel 12 Current Even harmonic distortion	R			Word
32C3H	Channel 12 Current K-Factor	R			Word

32C4H	Channel 13 Current Odd harmonic distortion	R			Word
32C5H	Channel 13 Current Even harmonic distortion	R			Word
32C6H	Channel 13 Current K-Factor	R			Word
32C7H	Channel 14 Current Odd harmonic distortion	R			Word
32C8H	Channel 14 Current Even harmonic distortion	R			Word
32C9H	Channel 14 Current K-Factor	R			Word
32CAH	Channel 15 Current Odd harmonic distortion	R			Word
32CBH	Channel 15 Current Even harmonic distortion	R			Word
32CCH	Channel 15 Current K-Factor	R			Word
32CDH	Channel 16 Current Odd harmonic distortion	R			Word
32CEH	Channel 16 Current Even harmonic distortion	R			Word
32CFH	Channel 16 Current K-Factor	R			Word

32D0H	Channel 17 Current Odd harmonic distortion	R			Word
32D1H	Channel 17 Current Even harmonic distortion	R			Word
32D2H	Channel 17 Current K-Factor	R			Word
32D3H	Channel 18 Current Odd harmonic distortion	R			Word
32D4H	Channel 18 Current Even harmonic distortion	R			Word
32D5H	Channel 18 Current K-Factor	R			Word
Channel 1-Channel 18 single-phase 3-line data					
3300H	Channel 1 current THD-I1	R			word
3301H	Channel 1 current THD-I2	R			word
.....	R			word
331EH	Channel 1 current THD-I31	R			word
331FH- 333DH	Channel 2 current harmonic data	R	Same as Channel 1		word
333EH- 335CH	Channel 3 current harmonic data	R	Same as Channel 1		word
335DH- 337BH	Channel 4 current harmonic data	R	Same as Channel 1		word
337CH- 339AH	Channel 5 current harmonic data	R	Same as Channel 1		word

339BH-33B9H	Channel 6 current harmonic data	R	Same as Channel 1		word
33BAH-33D8H	Channel 7 current harmonic data	R	Same as Channel 1		word
33D9H-33F7H	Channel 8 current harmonic data	R	Same as Channel 1		word
33F8H-3416H	Channel 9 current harmonic data	R	Same as Channel 1		word
3417H-3435H	Channel 10 current harmonic data	R	Same as Channel 1		word
3436H-3454H	Channel 11 current harmonic data	R	Same as Channel 1		word
3455H-3473H	Channel 12 current harmonic data	R	Same as Channel 1		word
3474H-3492H	Channel 13 current harmonic data	R	Same as Channel 1		word
3493H-34B1H	Channel 14 current harmonic data	R	Same as Channel 1		word
34B2H-34D0H	Channel 15 current harmonic data	R	Same as Channel 1		word
34D1H-34EFH	Channel 16 current harmonic data	R	Same as Channel 1		word
34F0H-350EH	Channel 17 current harmonic data	R	Same as Channel 1		word
350FH-352DH	Channel 18 current harmonic data	R	Same as Channel 1		word
Channel 1-Channel 6 3-phase 4-line/single -phase 3-line data					
352EH	Channel 1 3-phase 4-line/single -phase 3-line current unbalance	R			word

352FH	Channel 2 3-phase 4-line/single – phase 3-line current unbalance	R			word
3530H	Channel 3 3-phase 4-line/single – phase 3-line current unbalance	R			word
3531H	Channel 4 3-phase 4-line/single – phase 3-line current unbalance	R			word
3532H	Channel 5 3-phase 4-line/single – phase 3-line current unbalance	R			word
3533H	Channel 6 3-phase 4-line/single – phase 3-line current unbalance	R			word

Over/Under Limit Alarm

A High Byte indicates an alarming channel number 1-10. Low Byte: bit0 = 1 indicates alarming, bit0 = 0 indicates restoration.

Only one alarming record can be read each time. The reading will be implemented via the current alarming record number, and it can save up to 20 alarming records.

Function Code 03 is to read. Function Code 10 is to write.

Address	Parameter	Property	Range	Default	Data
---------	-----------	----------	-------	---------	------

3700H	Group 1: Alarm State	R	High byte: Alarm Channel 1-10 Bit0 1: Alarm happening 0: Alarm recovery		word
3701H	Group 1: Parameter Number	R	0-352		word
3702H	Group 1: Over limit or restoration value	R			word
3703H-3709H	Group 1: Happening Time	R	Year, Month, Day, Hour, Minute, Second, Millisecond		word
370AH	Newest alarm record number	R	1-20, 0 indicates no alarm record	0	word
370BH	Alarm Record Number currently being read	R/W	1-20	1	word

System Event Log

Records event happening and event. Please refer to Chapter 4 for details.

Only one record can be read every time via current event number, it can be saved up to 100 records.

Function Code 03 is to read. Function Code 10 is to write.

Address	Parameter	Property	Range	Default	Data
3800H-3805H	Event Happening Time	R	Year, Month, Day, Hour, Minute, Second		word
3806H	Event Marking		1-16 indicating 1-16 events		word
3807H	Newest Event Number		1-100, 0 indicates null	0	word

3808H	Event number currently being read	R/W	1-100	1	word
-------	-----------------------------------	-----	-------	---	------

SOE Record

When an event happens, SOE records the DI state and its time of occurrence. Each time only one SOE record can be read, via current SOE record setting, it can save up to 20 SOE records.

Function Code 03 is to read, Function Code 10 is to write.

Address	Parameter	Property	Range	Default	Data
3900H	DI SOE first record: Year	R			word
3901H	DI SOE first record: Month	R			word
3902H	DI SOE first record: Day	R			word
3903H	DI SOE first record: Hour	R			word
3904H	DI SOE first record: Minute	R			word
3905H	DI SOE first record: Second	R			word
3906H	DI SOE first record: millisecond high byte	R			word
3907H	DI SOE first record: millisecond low byte	R			word
3908H	DI SOE 1st record: status	R	Bit0-7 indicates the 8 channel's DI statue.1 means ON, 0 means OFF		word

3909H	Newest SOE record number	R	1-20, 0 means null		word
390AH	SOE record number being read	R/W	1-20		word

DI Pulse Counter and Value

DI can query the number of counts 1-8, pulse count value, pulse count value is the number of the set pulse count value obtained by multiplying the pulse counting dimension, plus get the value of units. Pulse count value is the actual value of the communication value divided by 100.

DI pulse counter remains when power is off. When DI type is changed from Pulse Counter to Signal Detection, the pulse number still remains. Function Code 03 is to read.

Address	Parameter	Property	Range	Default	Data Type	Format
3A00H-3A01H	DI1 Pulse Counter	R			dword	F1
3A02H-3A03H	DI2 Pulse Counter	R			dword	F1
3A04H-3A05H	DI3 Pulse Counter	R			dword	F1
3A06H-3A07H	DI4 Pulse Counter	R			dword	F1
3A08H-3A09H	DI5 Pulse Counter	R			dword	F1
3A0AH-3A0BH	DI6 Pulse Counter	R			dword	F1
3A0CH-3A0DH	DI7 Pulse Counter	R			dword	F1

3A0EH-3A0FH	DI8 Pulse Counter	R		dword	F1
3A10H-3A11H	DI1 Pulse Counter	R		float	F1
3A12H-3A13H	DI2 Pulse Counter	R		float	F1
3A14H-3A15H	DI3 Pulse Counter	R		float	F1
3A16H-3A17H	DI4 Pulse Counter	R		float	F1
3A18H-3A19H	DI5 Pulse Counter	R		float	F1
3A1AH-3A1BH	DI6 Pulse Counter	R		float	F1
3A1CH-3A1DH	DI7 Pulse Counter	R		float	F1
3A1EH-3A1FH	DI8 Pulse Counter	R		float	F1

DI State Parameter

1-8 DI status. Function Code 02 to read.

Address	Parameter	Property	Range	Default	Data
0000	DI1	R	1: ON, 0: OFF	0	bit
0001-0007	DI2~DI8	R	1: ON, 0: OFF	0	bit

RO state

1-4 channel Relay Output. Function Code 01 to read; function code 05 to write.

Address	Parameter	Property	Range	Default	Data
0000	RO1	R	1: ON, 0: OFF		bit

0001	RO2	R	1: ON, 0: OFF		bit
0002	RO3	R	1: ON, 0: OFF		bit
0003	RO4	R	1: ON, 0: OFF		bit

Daylight saving time setting

Function Code 03 to read; function code 10 to write.

Address	Parameter	Property	Range	Default	Data type
4000H	DST enable	R/W	0: disable 1: enable	0	word
4001H	DST format	R/W	0: format 1 1: format 2	0	word
4002H	DST Start Mon	R/W	1-12	1	word
4003H	DST Start Day	R/W	1-31	1	word
4004H	DST Start Hour	R/W	0-23	0	word
4005H	DST Start Min	R/W	0-59	0	word
4006H	DST Start Adjust time (Unit: Min)	R/W	1-120	60	word
4007H	DST Ending Mon	R/W	1-12	1	word
4008H	DST Ending Day	R/W	1-31	1	word
4009H	DST Ending Hour	R/W	0-23	0	word
400AH	DST Ending Min	R/W	0-59	0	word

400BH	DST Ending Adjust time (Unit: Min)	R/W	1-120	60	word
400CH	DST Start Mon	R/W	1-12	1	word
400DH	DST Start week	R/W	0-6 0: Sunday 1~6 Monday to Saturday	0	word
400EH	DST Start First few weeks	R/W	1-5	1	word
400FH	DST Start Hour	R/W	0-23	0	word
4010H	DST Start Min	R/W	0-59	0	word
4011H	DST Start Adjust time (Unit: Min)	R/W	1-120	60	word
4012H	DST Ending Mon	R/W	1-12	1	word
4013H	DST Ending Week	R/W	0-6 0: Sunday 1~6 Monday to Saturday	0	word
4014H	DST Ending First few weeks	R/W	1-5	1	word
4015H	DST Ending Hour	R/W	0-23	0	word

4016H	DST Ending Min	R/W	0-59	0	word
4017H	DST Ending Adjust time (Unit: Min)	R/W	1-120	60	word

Ten Years Holiday Setting

Function Code 03 to read; function code 10 to write.

Address	Parameter	Property	Range	Default	Data Type
4100H	Holiday setting enable	R/W	0: disable 1: enable	0	word
4101H	Start year holiday setting		0-99 Less than 10 years	0	
4102H	End year holiday setting		0-99	0	

The first year holiday setting

4103H-4105H	The 1st Holiday(Month, Day, Schedule Number)	R/W		00:00 0	
4106H-4108H	The 2nd Holiday(Month, Day, Schedule Number)	R/W		00:00 0	
4109H-410BH	The 3rd Holiday(Month, Day, Schedule Number)	R/W		00:00 0	
410CH-410EH	The 4th Holiday(Month, Day, Schedule Number)	R/W		00:00 0	

410FH- 4111H	The 5th Holiday(Month, Day, Schedule Number)	R/W		00:00 0	
4112H- 4114H	The 6th Holiday(Month, Day, Schedule Number)	R/W		00:00 0	
4115H- 4117H	The 7th Holiday(Month, Day, Schedule Number)	R/W		00:00 0	
4118H- 411AH	The 8th Holiday(Month, Day, Schedule Number)	R/W		00:00 0	
411BH- 411DH	The 9th Holiday(Month, Day, Schedule Number)	R/W		00:00 0	
411EH- 4120H	The 10th Holiday(Month, Day, Schedule Number)	R/W		00:00 0	
4121H- 4123H	The 11th Holiday(Month, Day, Schedule Number)	R/W		00:00 0	
4124H- 4126H	The 12th Holiday(Month, Day, Schedule Number)	R/W		00:00 0	
4127H- 4129H	The 13th Holiday(Month, Day, Schedule Number)	R/W		00:00 0	
412AH- 412CH	The 14th Holiday(Month, Day, Schedule Number)	R/W		00:00 0	

412DH- 412FH	The 15th Holiday(Month, Day, Schedule Number)	R/W		00:00 0	
4130H- 4132H	The 16th Holiday(Month, Day, Schedule Number)	R/W		00:00 0	
4133H- 4135H	The 17th Holiday(Month, Day, Schedule Number)	R/W		00:00 0	
4136H- 4138H	The 18th Holiday(Month, Day, Schedule Number)	R/W		00:00 0	
4139H- 413BH	The 19th Holiday(Month, Day, Schedule Number)	R/W		00:00 0	
413CH- 413EH	The 20th Holiday(Month, Day, Schedule Number)	R/W		00:00 0	
413FH- 4141H	The 21st Holiday(Month, Day, Schedule Number)	R/W		00:00 0	
4142H- 4144H	The 22nd Holiday(Month, Day, Schedule Number)	R/W		00:00 0	
4145H- 4147H	The 23rd Holiday(Month, Day, Schedule Number)	R/W		00:00 0	
4148H- 414AH	The 24th Holiday(Month, Day, Schedule Number)	R/W		00:00 0	

414BH- 414DH	The 25th Holiday(Month, Day, Schedule Number)	R/W		00:00 0	
414EH- 4150H	The 26th Holiday(Month, Day, Schedule Number)	R/W		00:00 0	
4151H- 4153H	The 27th Holiday(Month, Day, Schedule Number)	R/W		00:00 0	
4154H- 4156H	The 28th Holiday(Month, Day, Schedule Number)	R/W		00:00 0	
4157H- 4159H	The 29th Holiday(Month, Day, Schedule Number)	R/W		00:00 0	
415AH- 415CH	The 30th Holiday(Month, Day, Schedule Number)	R/W		00:00 0	
415DH	The 1st setting year	R/W		0	
415EH	Holiday number of the 1st year	R/W		0	
The 2nd year Holiday setting					
415FH- 41BAH	The same as to first year				
The 3rd year Holiday setting					
41BBH- 4216H	The same as to first year				
The 4th year Holiday setting					
4217H- 4272H	The same as to first year				
The 5th year Holiday setting					

4273H- 42CEH	The same as to first year				
The 6th year Holiday setting					
42CFH- 432AH	The same as to first year				
The 7th year Holiday setting					
432BH- 4386H	The same as to first year				
The 8th year Holiday setting					
4387H- 43E2H	The same as to first year				
The 9th year Holiday setting					
43E3H- 443EH	The same as to first year				
The 10th year Holiday setting					
443FH- 449AH	The same as to first year				

Appendix

Appendix A Technical Data and Specification

Appendix B Pulse Output Settings

Appendix C Ordering Information

Appendix D TP900 meter reader Instructions

Appendix E Version Information

Appendix A Technical Data and Specifications

1. Input

Voltage Input	
Voltage Rating	400Vac L-N, 690Vac L-L ⚠ CAT III
Overload	1500Vac Continuously; 2500Vac, 50/60Hz 1 minute
Input Impedance	2M Ω / phase
Frequency Range	45Hz-65Hz
PT Burden	<0.2VA

Current Input (Direct Input or Via CT)	
Via CT	
Solid Core CT, 20A, 80A, 150A, 200A	
Direct Input	
Each Tenant Max Current 20 (80) A ⚠ CAT III	

Measurement category III (CAT III) is for measurements performed in the building installation.

NOTE: Examples are measurements on distribution boards, circuit-breakers, wiring, including cables, bus-bars, junction boxes, switches, socket-outlets in the fixed installation, and equipment for industrial use and some other equipment, for example, stationary motors with permanent connection to the fixed installation.

2.Measurement

Parameter	Accuracy \pm (%rdg)	Resolution	Range
Real Energy	1%	0.01kWh	0~999999.9kwh
Voltage	0.5%	0.1V	10~400V
Current	0.5%	0.001A	5mA~10000A
Real Power	1%	0.1var	4000.0kW
Reactive Power	1%	0.1VA	4000.0kvar
Apparent Power	1%	0.1VA	4000.0kVA
Power Factor	1%	0.001	-1.000~1.000
Frequency	0.2%	0.01Hz	45~65Hz
Power Demand	1%	0.1W	4000.0kW
Current Demand	0.5%	0.001A	5mA~10000A
Harmonics	2%	0.01%	0~100%
Unbalance	1%	0.01%	0~100%
Meter Runtime		0.01 hour	0~999999.9 hours

3.IO

Digital Input(DI)	
Input Type	Dry Contact
Max Input Current	2 mA
Input Voltage	15-30 V
Start Voltage	12 V
Stop Voltage	10 V
Pulse Max Frequency	100 Hz, 50% Duty Ratio
SOE Resolution	2 ms

DI Power Supply (24V)	
Voltage	24 Vdc
Power	1 W

Relay Output(RO)	
Voltage	250 Vac, 30 Vdc
Load Current	3 A
Set Time	10 ms(Max)
Contact Resistance	100 mΩ(Max)
Isolation Voltage	2500 V
Mechanical Life	1.5×10^7

4.Power Supply

Power Supply	100-415Vac, 50/60Hz; 100-300Vdc
Burden	5W

5.Environment

Operation Temperature	-25°C-70°C
Power Consumption	1 W
Relative Humidity	5%-95% non-condensing
Elevation above sea level	3000 m

6. Measurement Standard

Measurement Standard	
IEC62053-21	Static meters for active energy (classes 1 and 2)
Environmental Standard	IEC 60068-2
Safety Standard	IEC 61010-1, UL 61010-1

Appendix B Pulse Output Setup

Set Value	Output(Active energy pulse output circuit)
0	No Output
1	Channel1 single-phase
2	Channel 2 single-phase
3	Channel 3 single-phase
4	Channel 4 single-phase
5	Channel 5 single-phase
6	Channel 6single-phase
7	Channel 7 single-phase
8	Channel 8 single-phase
9	Channel 9 single-phase
10	Channel 10 single-phase
11	Channel 11 single-phase
12	Channel 12 single-phase
13	Channel 13 single-phase
14	Channel 14 single-phase
15	Channel 15 single-phase
16	Channel 16 single-phase
17	Channel 17 single-phase
18	Channel 18 single-phase
19	Channel 1 3-phase 4-line user/ Single-phase 3-line user total
20	Channel 2 3-phase 4-line user/ Single-phase 3-line user total
21	Channel 3 3-phase 4-line user/ Single-phase 3-line user total
22	Channel 4 3-phase 4-line user/ Single-phase 3-line user total
23	Channel 5 3-phase 4-line user/ Single-phase 3-line user total

24	Channel 6 3-phase 4-line user/ Single-phase 3-line user total
25	Inline total
26	Inline A phase
27	Inline B phase
28	Inline C phase

Appendix C Ordering Information

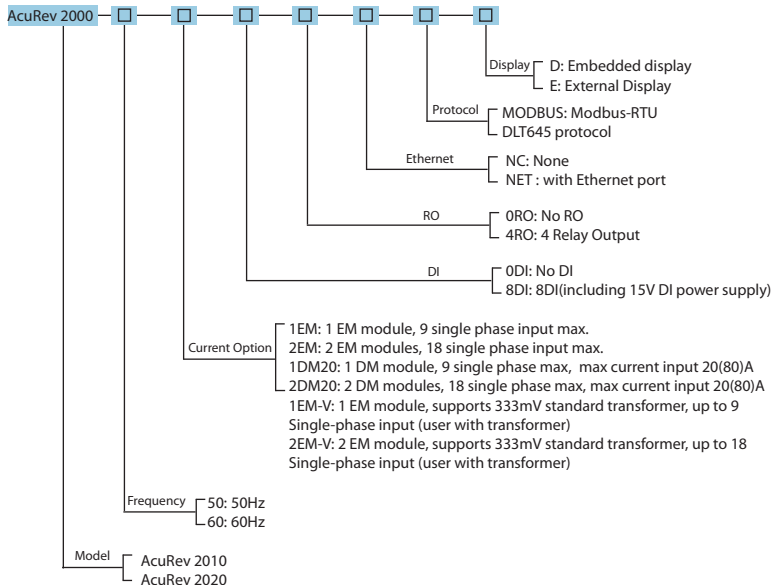

Current Transformer

Solid Core

CCT- 

Type

CCT-20 : Full Range 20A
CCT-80 : Full Range 80A
CCT-150 : Full Range 150A
CCT-200 : Full Range 200A

SCT- 

Type

SCT-20 : Full Range 20A
SCT-80 : Full Range 80A
SCT-150 : Full Range 150A
SCT-200 : Full Range 200A
SCT-250 : Full Range 250A
SCT-1000 : Full Range 1000A

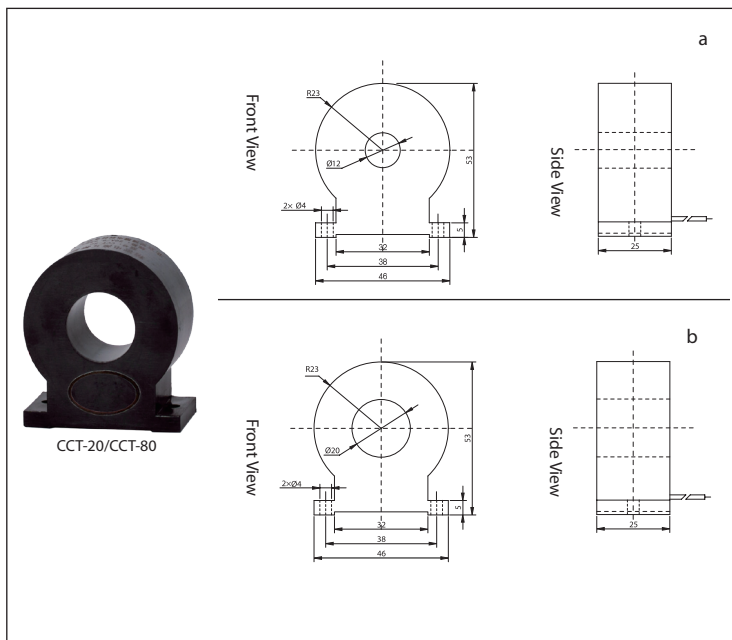

Type	Φ	Height(mm)	Length(mm)	Width(mm)	Dimensions
CCT-20	12	53	46	25	Figure-a
CCT-80	20	53	46	25	Figure-b

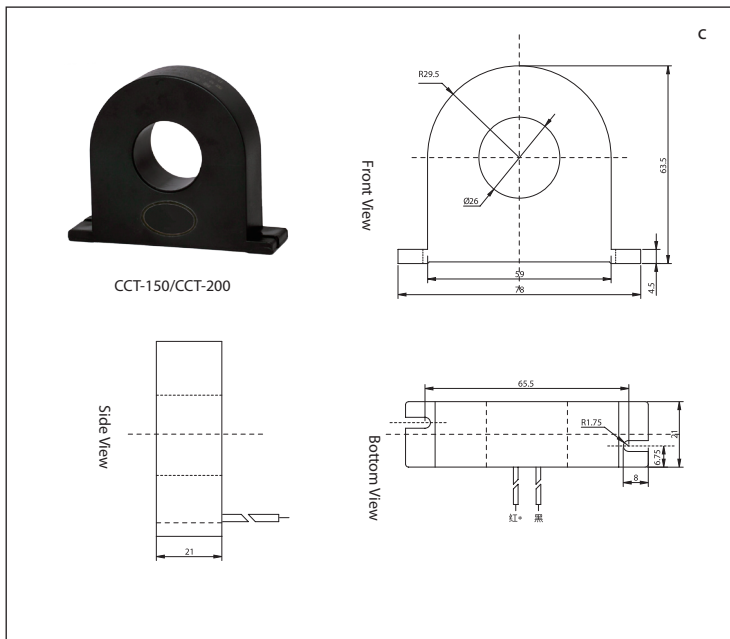

CCT-150/CCT-200

Type	Φ	Height(mm)	Length(mm)	Width(mm)	Dimensions
CCT-150	26	63.5	78	21	Figure-c
CCT-200	26	63.5	78	21	

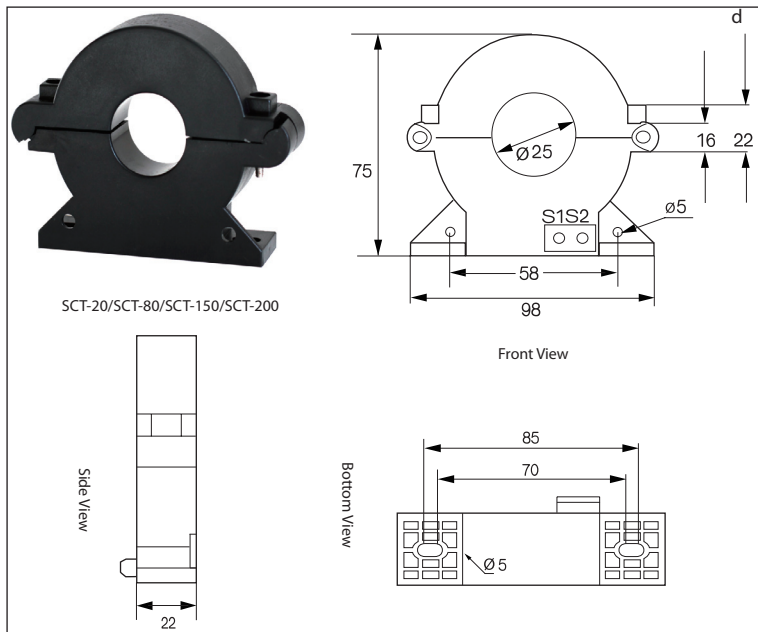

Type	Φ	Height (mm)	Length (mm)	Width (mm)	Dimensions
SCT-20	25	75	98	22	Figure-c
SCT-80	25	75	98	22	
SCT-150	25	75	98	22	
SCT-200	25	75	98	22	

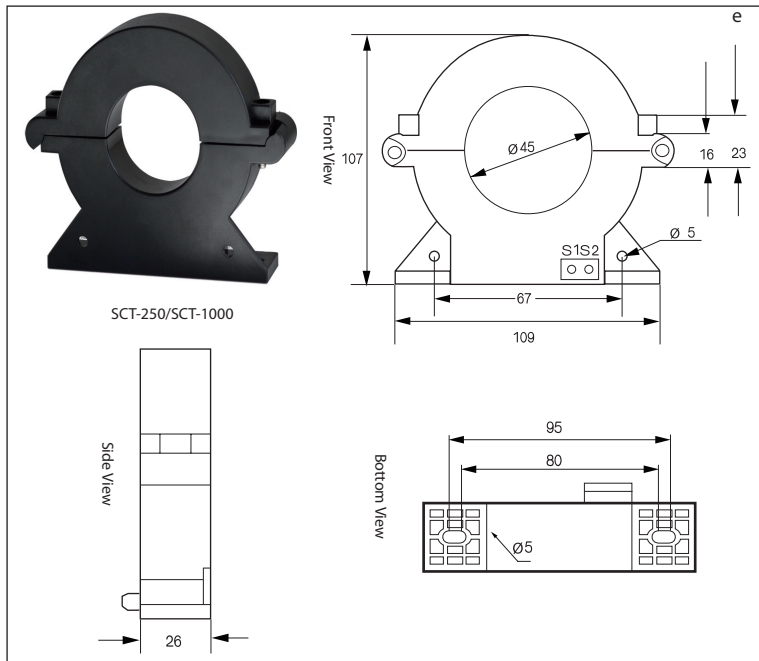

Type	Φ	Height(mm)	Length(mm)	Width(mm)	Dimensions
SCT-250	45	107	109	26	Figure-d
SCT-1000	45	107	109	26	

Appendix D TP900 meter reader Instructions

AcuRev 2000 series meters support on-site infrared meter reader, meter reading before, meter reader and meter needs for simply setup, and then use the TP900 meter reader reads the brightest active energy values.

1. TP900 meter reader settings

Boot into the main menu, as shown in Figure 1. Select "7.Exec Program", press "ENTER"

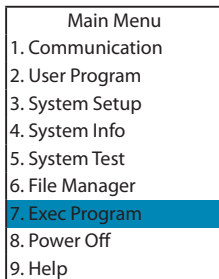

key to enter into the program list screen, shown in Figure 2.

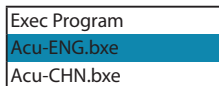

Figure 1

Figure 2

There are two programs to choose from, Acu-ENG.bxe is the English program, Acu-CHI.bxe is the Chinese program. To use English program, you can use "up" and "down" keys

option to Acu-ENG.bxe, as shown in Figure 2, and then right-click Figure 3 will appear "**", then you set the default process of meter reader . Return to the main menu, enter "2.User Program", as shown in Figure 4, the English program will be executed, and after boot, it will go directly to the English program. If you want to set Chinese program, it same as to English program setting.

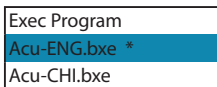

Figure 3

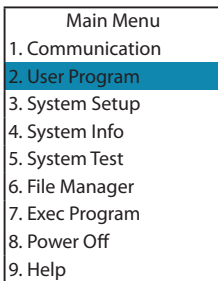

Figure 4

2, on-site infrared meter reading

AcuRev 2000 infrared meter reader default baud rate is 1200bps,open the TP900 meter reader, enter the interface, as shown in Figure 5

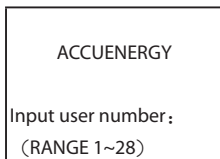

Figure 5

After the "Input user number:" input user number, the value range from 1 to 28, 1 to 28 are read values in Table 1 have the following meanings.

User	Energy
1	Channel 1 single-phase active energy value
2	Channel 2 single-phase active energy value
3	Channel 3 single-phase active energy value
4	Channel 4 single-phase active energy value
5	Channel 5 single-phase active energy value
6	Channel 6 single-phase active energy value
7	Channel 7 single-phase active energy value
8	Channel 8 single-phase active energy value
9	Channel 9 single-phase active energy value
10	Channel 10 single-phase active energy value
11	Channel 11 single-phase active energy value
12	Channel 12 single-phase active energy value
13	Channel 13 single-phase active energy value
14	Channel 14 single-phase active energy value
15	Channel 15 single-phase active energy value
16	Channel 16 single-phase active energy value
17	Channel 17 single-phase active energy value
18	Channel 18 single-phase active energy value

19	Channel 1 three phase/single –three phase total active energy value
20	Channel 2 three phase/single –three phase total active energy value
21	Channel 3 three phase/single –three phase total active energy value
22	Channel 4 three phase/single –three phase total active energy value
23	Channel 5 three phase/single –three phase total active energy value
24	Channel 6 three phase/single –three phase total active energy value
25	Inline total active energy value
26	Inline Phase A active energy value
27	Inline Phase B active energy value
28	Inline Phase C active energy value

AcuRev 2000

user number: 5
energy: 5.0kWh
address: 012345678999

Figure 6

After input user number, press "ENTER" button to start meter reading, when meter reading, meter reader will read the meter 645 addresses, and then according to 645 addresses and user number to read energy data. If we can read the data correctly, the meter reader can show the value of the household's electricity and 645 address (A5 ~ A0 displayed in the order), as shown in Figure 6, Energy is 5.0kWh, 645 address 012345678999 (A5 ~ A0 order), press any key to return to the main interface, you can re-read the other ones of the energy value.

Appendix E Revision History

Version	Date	Description
V1.01	2012.04.20	1 st edition
V1.02	2012.08.08	P95: Add the range of measured values
V2.01	2013.08.02	<ol style="list-style-type: none">1. Add the network module content2. Redefining wiring, the user name3. CT mix to increase user functionality4. Improve Measurement Accuracy of Meter5. Add daylight saving time and ten holidays automatic switching function
V2.10	2014.01.07	<ol style="list-style-type: none">1. Add seals Description2. Add channel options described3. Add the rated voltage described