

MODEL 9305

Compact Clamp-On Meter

Instruction Manual



PN: 84-901

1.888.610.7664

 www.calcert.com

sales@calcert.com

Safety

International Safety Symbols



This symbol, adjacent to another symbol or terminal, indicates the user must refer to the manual for further information.



This symbol, adjacent to a terminal, indicates that, under normal use, hazardous voltages may be present



Double insulation

SAFETY NOTES

- Do not exceed the maximum allowable input range of any function
- Do not apply voltage to meter when resistance function is selected.
- Set the function switch OFF when the meter is not in use.

WARNINGS

- Set function switch to the appropriate position before measuring.
- When measuring volts do not switch to current/resistance modes.
- When changing ranges using the selector switch always disconnect the test leads from the circuit under test.
- Do not exceed the maximum rated input limits.

CAUTIONS

Improper use of this meter can cause damage, shock, injury or death. Read and understand this user manual before operating the meter.

Always remove the test leads before replacing the battery.

Inspect the condition of the test leads and the meter itself for any damage before operating the meter. Repair or replace any damage before use.

Use great care when making measurements if the voltages are greater than 25VAC rms or 35VDC. These voltages are considered a shock hazard.

Remove the battery if the meter is to be stored for long periods. Always discharge capacitors and remove power from the device under test before performing Diode, Resistance or Continuity tests.

- Voltage checks on electrical outlets can be difficult and misleading because of the uncertainty of connection to the recessed electrical contacts. Other means should be used to ensure that the terminals are not "live".
- If the equipment is used in a manner not specified by the manufacturer, the protection provided by the equipment may be impaired.

Input Limits	
Function	Maximum Input
A AC	400A
V DC, V AC	600V DC/AC
Frequency, Resistance, Diode, Continuity , Capacitance Test	600V DC/AC
Temperature (°C/°F)	600V DC/ AC

Meter Description

1. Current clamp
2. Non-contact AC voltage indicator light
3. Clamp trigger
4. Data Hold button/Backlite
5. Rotary Function switch
6. MODE select button
7. Hz% Hold button
8. Relative button
9. LCD display
10. COM input jack
11. V Ω CAP TEMP Hz jack
12. Battery Cover

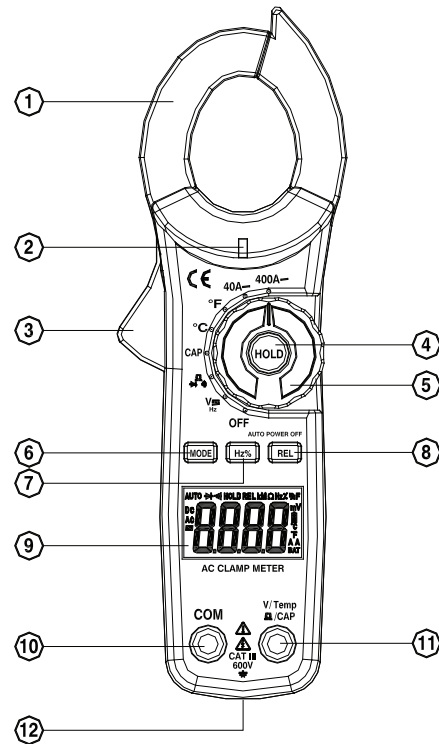

1. **AC DC** AC (alternating current) and DC (direct current)
2. **—** Minus sign
3. **8.8.8.8** 4000 count (0 to 3999) measurement reading
4. **AUTO** AutoRange mode
5. **REL** Relative mode
6. **→|** Diode test mode
7. **•)))** Audible Continuity
8. **HOLD** Data Hold mode
9. **°C, °F, μ , m, V, A, K, M, Ω** , Units of measure list
10. **Hz %** Frequency/duty cycle test mode



Specifications

Function	Range & Resolution	Accuracy (% of reading)
AC Current (50/60Hz)	40.00AAC	$\pm (2.5 \% + 8 \text{ digits})$
	400.0 AAC	$\pm (2.8 \% + 8 \text{ digits})$
DC Voltage	400.0 mVDC	$\pm (0.8\% + 2 \text{ digits})$
	4.000 VDC	$\pm (1.5\% + 2 \text{ digits})$
	40.00 VDC	
	400.0 VDC	
	600.0 VDC	$\pm (2 \% + 2 \text{ digits})$
AC Voltage (50-400Hz)	4.000 VAC	$\pm (1.8\% + 8 \text{ digits})$
	40.00 VAC	
	400.0 VAC	
	600.0 VAC	$\pm (2.5\% + 8 \text{ digits})$
Resistance	400.0 Ω	$\pm (1.0\% + 4 \text{ digits})$
	4.000K Ω	$\pm (1.5\% + 2 \text{ digits})$
	40.00K Ω	
	400.0K Ω	
	4.000M Ω	$\pm (2.5\% + 3 \text{ digits})$
	40.00M Ω	$\pm (3.5\% + 5 \text{ digits})$
Capacitance	40.00nF	$\pm (4.0\% \text{ reading} + 20 \text{ digits})$
	400.0nF	$\pm (3\% \text{ reading} + 5 \text{ digits})$
	4.000 μ F	
	40.00 μ F	
	100.0 μ F	$\pm (4.0\% \text{ reading} + 10 \text{ digits})$
Frequency Sensitivity:15Vrms	10-10kHz	$\pm (1.5\% \text{ reading} + 2 \text{ digits})$
Temp (type-K) (probe accuracy not included)	-20.0 to 760.0°C	$\pm (3\% \text{rdg} + 5^\circ\text{C})$
	-4.0 to 1400.0°F	$\pm (3\% \text{rdg} + 9^\circ\text{F})$

Clamp size	Opening 1.2" (30mm) approx
Diode Test	Test current of 0.3mA typical; Open circuit voltage 1.5V DC typical.
Continuity Check	Threshold <150Ω; Test current < 0.5mA
Low Battery Indication	 " " is displayed
Overrange Indication	"OL" is displayed
Measurements Rate	2 per second, nominal
Input Impedance	10MΩ (VDC and VAC)
Display	4000 counts LCD
AC Current	50-60Hz (AAC)
AC Voltage bandwidth	50-400Hz (VAC)
Operating Temperature	41 to 104°F (5 to 40°C)
Storage Temperature	-4 to 140°F (-20 to 60°C)
Operating Humidity	Max 80% up to 87°F (31°C) decreasing linearly to 50% at 104°F(40°C)
Storage Humidity	<80%
Operating Altitude	7000ft. (2000meters) maximum.
Over voltage	Category III 600V
Battery	Two "AAA" 1.5V Battery
Auto OFF	approx. 30 minutes
Dimensions/Weight	200x66x37mm/205g
Safety	For indoor use and in accordance with Overvoltage Category II, Pollution Degree 2. Category II includes local level, appliance, portable equipment, etc., with transient overvoltages less than Overvoltage Cat. III

Operation

NOTICES: Read and understand all **warning** and **precaution** statements listed in the safety section of this operation manual prior to using this meter. Set the function select switch to the OFF position when the meter is not in use.

AC Current Measurements

WARNING: Ensure that the test leads are disconnected from the meter before making current clamp measurements.

1. Set the Function switch to the **400** or **40A** range.
2. If the range of the measured is not known, select the higher range first then move to the lower range if necessary.
3. Press the trigger to open jaw. Fully enclose one conductor to be measured.

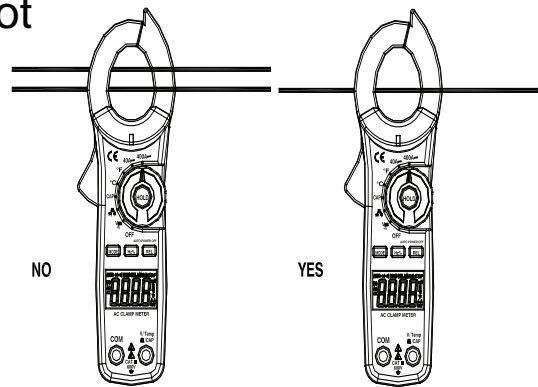

The clamp meter LCD will display the reading.



DC/AC Voltage Measurements

1. Insert the black test lead into the negative **COM** terminal and the red test lead into the positive **V** terminal.
2. Set the function switch to the V position.
3. Select AC or DC with the **MODE** button.
4. Connect the test leads in parallel to the circuit under test.
5. Read the voltage measurement on the LCD display.

Resistance Measurements

1. Insert the black test lead into the negative **COM** terminal and the red test lead into the positive terminal.
2. Set the function switch to the Ω  $\bullet)))$ position.
3. Touch the test probe tips across the circuit or component under test. It is best to disconnect one side of the device under test so the rest of the circuit will not interfere with the resistance reading.
4. For Resistance tests, read the resistance on the LCD display.

Diode and Continuity Measurements

1. Insert the black test lead banana plug into the negative **COM** jack and the red test lead banana plug into the positive diode jack.
2. Turn the rotary switch to the Ω  $\bullet)))$ position.
3. Press the **MODE** button until “” appears in the display.
4. Touch the test probes to the diode under test. Forward voltage will indicate 0.4V to 0.7V. Reverse voltage will indicate “**OL**”. Shorted devices will indicate near 0mV and an open device will indicate “**OL**” in both polarities.

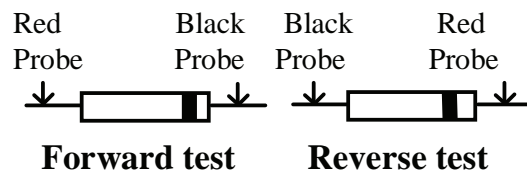

For Continuity tests, if the resistance is < 150 , a tone will sound.

Capacitance Measurements

WARNING: To avoid electric shock, disconnect power to the unit under test and discharge all capacitors before taking any capacitance measurements. Remove the batteries and unplug the line cords.

1. Set the rotary function switch to the **CAP** position.
2. Insert the black test lead banana plug into the negative (COM) jack. Insert the red test lead banana plug into the positive (V) jack.
3. Touch the test leads to the capacitor to be tested.
4. Read the capacitance value in the display

Frequency or % duty cycle measurements

1. Set the rotary function switch to the “VDC/AC,Hz” position.
2. Insert the black lead banana plug into the negative COM jack and the red test lead banana plug into the positive V jack.
3. Select Hz or % duty with the **Hz/%** button.
4. Touch the test probe tips to the circuit under test.
5. Read the frequency on the display.

Temperature Measurements

WARNING: To avoid electric shock, disconnect both test probes from any source of voltage before making a temperature measurement.

1. Set the function switch to **°C** or **°F**.
2. Insert the Temperature Probe into the negative (COM) and the V jacks, making sure to observe the correct polarity.

3. Touch the Temperature Probe head to the part whose temperature you wish to measure. Keep the probe touching the part under test until the reading stabilizes (about 30 seconds).
4. Read the temperature in the display. The digital reading will indicate the proper decimal point and value.

WARNING: To avoid electric shock, be sure the thermocouple has been removed before changing to another measurement function

Non-Contact AC Voltage Measurements

WARNING: Risk of Electrocution. Before use, always test the Voltage Detector on a known live circuit to verify proper operation

1. Turn meter On to any setting. The AC Voltage Detector is located at the tip of the AC current clamp at the 'lightning bolt' marks. Only the outside of the clamp, in the 'notch' at the clamp separation, is sensitive to AC voltage. Clamping the jaws around a live wire will not necessarily cause the AC Voltage Detector to sense the 'live' wire.

2. If AC voltage is present, the red AC Voltage indicator will light.

NOTE: The conductors in electrical cords are often twisted and the position of the 'hot' wire is unknown. For best results, hold the cord in the notch of the clamp while running it along the length of the cord.

NOTE: The detector is designed with high sensitivity. Static electricity or other sources of energy may randomly cause the red indicator to light. This is normal operation.

MODE BUTTON

To select DC/ACV, OHM/ Diode/Continuity

Data Hold Button / Backlite

To freeze the LCD meter reading, press the data hold button. While data hold is active, the **HOLD** display icon appears on the LCD. Press the data hold button again to return to normal operation.

The **HOLD** button also turns the Backlite on and off. Press it for about 2 seconds to turn the light on. Press it again for 2 seconds to turn the light off. The light will turn off automatically in about 30 minutes if the buttons or knob on the meter are not operated.

NOTE: Turning the Backlite on and off also turns **HOLD** on and off. Use short presses of the button to control **HOLD**, and long presses to control the Backlite. Any combination of **HOLD** and Backlite can be obtained.

REL BUTTON

For Capacitance Zero & Offset adjustment.

RANGE BUTTON

When the meter is first turned on, it automatically goes into AutoRanging. This automatically selects the best range for the measurements being made and is generally the best mode for most measurements. For measurement situations requiring that a range be manually selected, perform the following:

1. Press the RANGE button. The “Auto Range” display indicator will turn off, The “Manual Range” display indicator will turn on
2. Press the RANGE button to step through the available ranges until you select the range you want.
3. Press and hold the RANGE button for 2 seconds to exit the ManualRanging mode and return to AutoRanging.

Battery Replacement

1. Remove the 2 rear Phillips head screw
2. Open the battery compartment
3. Replace the 2 “AAA’ batteries (1.5V, UM4, R03)
4. Re-assemble the meter

Triplett Three Year Limited

Triplett warrants instruments and test equipment manufactured by it to be free from defective material or workmanship and agrees to repair or replace such products which, under normal use and service, disclose the defect to be the fault of our manufacturing, with no charge within three years of the date of original purchase for parts and labor. If we are unable to repair or replace the product, we will make a refund of the purchase price. Consult the Instruction Manual for instructions regarding the proper use and servicing of instruments and test equipment. Our obligation under this warranty is limited to repairing, replacing, or making refund on any instrument or test equipment which proves to be defective within three years from the date of original purchase. This warranty does not apply to any of our products which have been repaired or altered by unauthorized persons in any way so as, in our sole judgment, to injure their stability or reliability, or which have been subject to misuse, abuse, misapplication, negligence, accident or which have had the serial numbers altered, defaced, or removed. Accessories, including batteries and fuses, not of our manufacture used with this product are not covered by this warranty.

**ALL WARRANTIES IMPLIED BY LAW ARE HEREBY LIMITED
TO A PERIOD OF THREE YEARS FROM DATE OF**

PURCHASE, AND THE PROVISIONS OF THE WARRANTY ARE EXPRESSLY IN LIEU OF ANY OTHER WARRANTIES EXPRESSED OR IMPLIED.

The purchaser agrees to assume all liability for any damages and bodily injury which may result from the use or misuse of the product by the purchaser, his employees, or others, and the remedies provided for in this warranty are expressly in lieu of any other liability Triplett may have, including incidental or consequential damages. Some states (USA ONLY) do not allow the exclusion or limitation of incidental or consequential damages, so the above limitation or exclusion may not apply to you. No representative of Triplett / Jewell Instruments or any other person is authorized to extend the liability of Triplett in connection with the sale of its products beyond the terms hereof.

Triplett reserves the right to discontinue models at any time, or change specifications, price or design, without notice and without incurring any obligation. This warranty gives you specific legal rights, and you may have other rights which vary from state to state.