



**INSTRUMENTS**

# **SDM-03 Docking Station Standalone Configuration Operator's Manual**

**Part Number: 71-0359**

**Revision: P1**

**Released: 4/7/15**

---

## Warranty

RKI Instruments, Inc. warrants gas alarm equipment sold by us to be free from defects in materials and workmanship, and performance for a period of one year from date of shipment from RKI Instruments, Inc. Any parts found defective within that period will be repaired or replaced, at our option, free of charge. This warranty does not apply to those items which by their nature are subject to deterioration or consumption in normal service, and which must be cleaned, repaired, or replaced on a routine basis. Examples of such items are:

Absorbent cartridges	Batteries
Pump diaphragms and valves	Filter elements
Fuses	

Warranty is voided by abuse including mechanical damage, alteration, rough handling, or repairs procedures not in accordance with the instruction manual. This warranty indicates the full extent of our liability, and we are not responsible for removal or replacement costs, local repair costs, transportation costs, or contingent expenses incurred without our prior approval.

THIS WARRANTY IS EXPRESSLY IN LIEU OF ANY AND ALL OTHER WARRANTIES AND REPRESENTATIONS, EXPRESSED OR IMPLIED, AND ALL OTHER OBLIGATIONS OR LIABILITIES ON THE PART OF RKI INSTRUMENTS, INC. INCLUDING BUT NOT LIMITED TO THE WARRANTY OF MERCHANTABILITY OR FITNESS FOR A PARTICULAR PURPOSE. IN NO EVENT SHALL RKI INSTRUMENTS, INC. BE LIABLE FOR INDIRECT, INCIDENTAL, OR CONSEQUENTIAL LOSS OR DAMAGE OF ANY KIND CONNECTED WITH THE USE OF ITS PRODUCTS OR FAILURE OF ITS PRODUCTS TO FUNCTION OR OPERATE PROPERLY.

This warranty covers instruments and parts sold to users only by authorized distributors, dealers, and representatives as appointed by RKI Instruments, Inc.

We do not assume indemnification for any accident or damage caused by the operation of this gas monitor and our warranty is limited to replacement of parts or our complete goods.

---

## Table of Contents

<b>Chapter 1: Introduction</b> .....	<b>1</b>
Overview .....	1
About the SDM-03 .....	1
System Requirements .....	2
Specifications .....	3
About This Manual .....	5
Cautions & Safety Information .....	5
<b>Chapter 2: Description</b> .....	<b>6</b>
Overview .....	6
AC Adapter .....	6
<i>Single-Port AC Adapter</i> .....	6
<i>4-Port AC Adapter</i> .....	6
USB Cable .....	7
Air Filter and Sample Tubing .....	7
Instrument Cradle .....	9
Back Panel .....	10
<i>Power Jack</i> .....	10
<i>Sample Fittings</i> .....	10
<i>PC Connection</i> .....	10
Control Panel .....	11
Front Panel .....	13
<b>Chapter 3: Preparing to Use the SDM-03</b> .....	<b>14</b>
Overview .....	14
Hardware Assembly .....	14
Setting the Operational Parameters in Edit Mode .....	15
<i>Bump Test &amp; Calibration Parameters</i> .....	15
<i>Turning on the SDM-03 with an Instrument</i> .....	17
<i>Setting the Bump Test Parameters</i> .....	19
<i>Setting the Calibration Parameters</i> .....	21
Connecting Calibration Gas .....	23



Installing the Single Module Data Viewer Software . . . . .	24
<b>Chapter 4: Operation . . . . .</b>	<b>25</b>
Overview . . . . .	25
Bump Testing an 03 Series . . . . .	25
Calibrating an 03 Series . . . . .	33
Troubleshooting . . . . .	39
Calibration and Bump Test Records . . . . .	41
<i>Available Memory in the SDM-03 . . . . .</i>	<i>41</i>
<i>Copying Calibration and Bump Test Records . . . . .</i>	<i>41</i>
<i>Clearing the SDM-03's Memory . . . . .</i>	<i>42</i>
<i>Bump Test and Calibration Record Files . . . . .</i>	<i>42</i>
<i>Bump Testing or Calibrating and Saving Files to a Flash Drive</i>	
<i>Multiple Times in One Day . . . . .</i>	<i>43</i>
<b>Chapter 5: Single Module Data Viewer Program . . . . .</b>	<b>44</b>
Overview . . . . .	44
Launching the Single Module Data Viewer Program . . . . .	44
<i>Data Viewing Window . . . . .</i>	<i>45</i>
Using the Single Module Data Viewer Program . . . . .	45
<i>Importing Files Into the Database . . . . .</i>	<i>46</i>
<i>Organizing the Data . . . . .</i>	<i>47</i>
<i>Viewing the Data . . . . .</i>	<i>48</i>
<i>Deleting Data . . . . .</i>	<i>53</i>
<i>Changing the Password . . . . .</i>	<i>54</i>
<i>Exiting the Program . . . . .</i>	<i>55</i>
<b>Spare Parts List . . . . .</b>	<b>55</b>

---

**CAUTION:**    *Read and understand this manual before using the SDM-03. Also read and understand the GP-03 and OX-03/CO-03/HS-03 Operator's Manuals.*

---

# Chapter 1: Introduction

---

## Overview

This chapter briefly describes the SDM-03 Docking Station and the Single Module Data Viewer Program. This chapter also describes the *SDM-03 Docking Station Standalone Operation Operator's Manual* (this document). Table 1 at the end of this chapter lists the SDM-03's specifications.

---

## About the SDM-03

The SDM-03 Docking Station is an advanced, reliable system that provides calibration, bump testing, and calibration and bump test records for the 03 Series portable gas monitors. It is designed to save the calibration and bump test records to a USB flash drive (standalone functionality) or to be connected directly to a computer (PC controlled functionality). If calibration and bump test records are stored to a USB flash drive while operating in the standalone configuration, the Single Module Data Viewer Program can then be used with a Windows-based personal computer to retrieve calibration and bump test data files from the USB flash drive or from the computer's hard drive if the files have been transferred to the hard drive from the flash drive. If you are using the PC Controller Program while operating in the PC controlled configuration, you may retrieve instrument data, bump test, and calibrate up to 10 instruments at once. Instrument information and data for each instrument can be viewed directly using the PC Controller Program and can be printed from the PC Controller Program. For instructions to use the SDM-03 with the PC Controller Program, see the *SDM-03 Docking Station PC Controlled Configuration Operator's Manual*.

The purpose of this manual is to explain how to set up and use the SDM-03 in Standalone configuration. It also explains how to use the Single Module Data Viewer Program. You will learn how to:

- install and launch the Single Module Data Viewer Program
- prepare the SDM-03 for use
- perform a bump test
- perform a calibration
- save calibration and bump test records to a USB flash drive
- view, print, and export calibration and bump test records

---

**CAUTION:** *The 03 Series detects oxygen deficiency, elevated levels of oxygen, combustible gases, carbon monoxide, or hydrogen sulfide, all of which can be dangerous or life threatening. When using the 03 Series, you must follow the instructions and warnings in the GP-03 and OX-03/CO-03/HS-03 Operator's Manuals to assure proper and safe operation of the instrument and to minimize the risk of personal injury.*

---

---

**CAUTION:** *The operator of this instrument is advised that if the equipment is used in a manner not specified in this manual, the protection provided by the equipment may be impaired.*

---

---

## System Requirements

To use the Single Module Data Viewer Software, your personal computer must meet the following requirements:

- **Operating Systems:** Windows<sup>®</sup> 7 or Windows<sup>®</sup> 8.
- **Processor:** IBM<sup>®</sup> compatible PC running Pentium<sup>®</sup> 2 processor or equivalent minimum
- **Memory:** 32 MB RAM minimum
- **Hard Disk Space:** 32 MB minimum
- **CD-ROM Drive**
- **Available USB port**

---

## Specifications

**Table 1: SDM-03 Specifications**

Input Power	12 VDC NOTE: AC Adapter with 100 - 240 VAC, 50/60 Hz, 0.6A input and 12 VDC, 1.2A output provided as standard.
Environmental Conditions	<ul style="list-style-type: none"><li>• For Indoor Use Only</li><li>• -10° C to 40° C, below 80% Relative Humidity, Non-Condensing</li></ul>
Applicable Instruments	<ul style="list-style-type: none"><li>• GP-03</li><li>• OX-03</li><li>• CO-03</li><li>• HS-03</li></ul>
Memory Capacity	64 KB
Maximum Record Size	256 bytes
Maximum Number of Records Saved	200
Number of Calibration Gas Cylinders	One calibration gas cylinder per bump test or calibration

**Table 1: SDM-03 Specifications**

Standard Accessories	<ul style="list-style-type: none"><li>• AC Adapter</li><li>• USB Flash Drive</li><li>• Single Module Data Viewer Program</li><li>• SDM-GX Docking Station PC Controller Program</li><li>• Inlet Air Filter</li><li>• Instruction Manual</li><li>• 10 Foot Long Exhaust Tube</li><li>• One 3 Foot Long Tube for GAS Fitting</li><li>• 10 Foot Long 3/16 Inch Tube for GAS manifolding (used for PC Controlled Configuration only)</li><li>• 2 T-Fittings (used for PC Controlled Configuration only)</li><li>• Check Valve (used for PC Controlled Configuration only)</li><li>• USB Cable, Type A to Type B</li></ul>
----------------------	---



---

## About this Manual

The *SDM-03 Docking Station Standalone Configuration Operator's Manual* uses the following conventions for notes, cautions, and warnings.

---

**NOTE:** Describes additional or critical information.

---

---

**CAUTION:** *Describes potential damage to equipment.*

---

---

**WARNING:** *Describes potential danger that can result in injury or death.*

---

---

## Cautions & Safety Information

- Use only polyurethane sample tubing with the SDM-03. Consult RKI Instruments, Inc. for other materials.
- Do not subject the SDM-03 to infrared or intense light. This may cause communication errors.
- Do not expose the SDM-03 to water.
- Do not subject the SDM-03 to any hard impact.

# Chapter 2: Description

---

## Overview

This section describes the SDM-03 docking station. It is designed to be used on a table top and consists of the AC adapter, Type A to Type B USB cable, air filter, check valve, 2 plastic T-fittings, sample tubing, instrument cradle, back panel, control panel, status LEDs, and 2 USB ports.

---

## AC Adapter

### Single-Port AC Adapter

The single-port AC adapter is a wall plug style adapter with a 5 foot cable. The end of the cable has a plug that connects to the power jack on the SDM-03's back panel. The AC adapter is rated 100 - 240 VAC input, 12 VDC 1.2 A output.

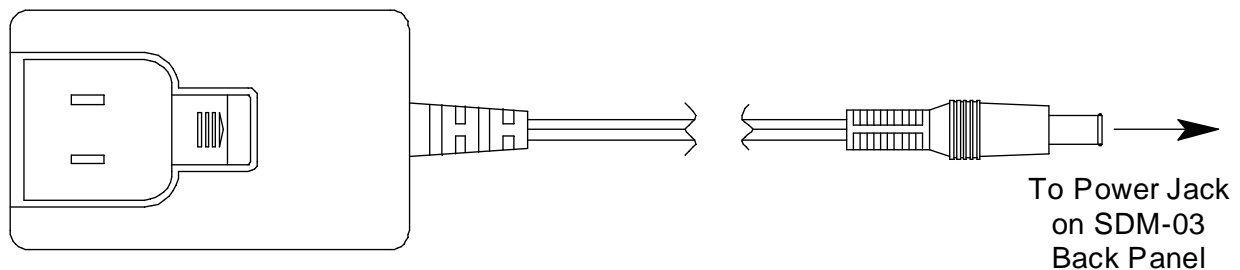

Figure 1: Single-Port AC Adapter

### 4-Port AC Adapter

The 4-port AC adapter is a wall plug style adapter with four 5-foot cables. The end of each cable has a plug that connects to the power jack on the SDM-03's back panel. The AC adapter is rated 100 - 240 VAC input, 12 VDC 2.0 A output.

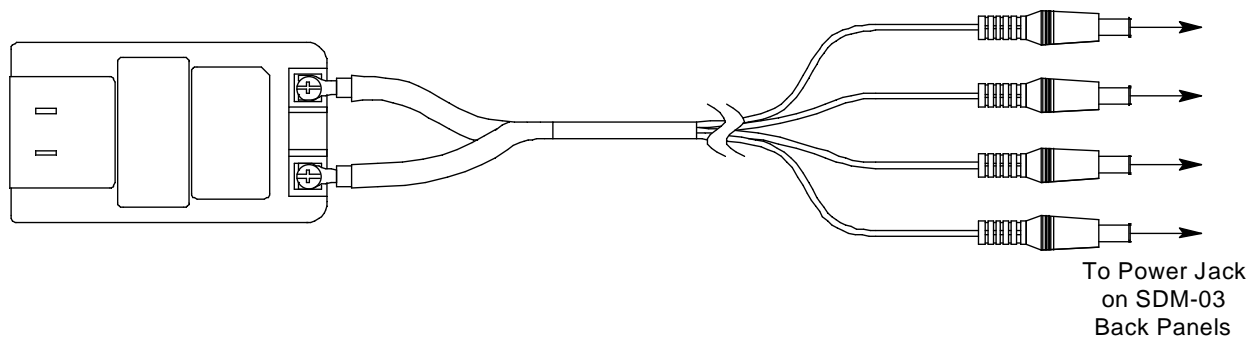
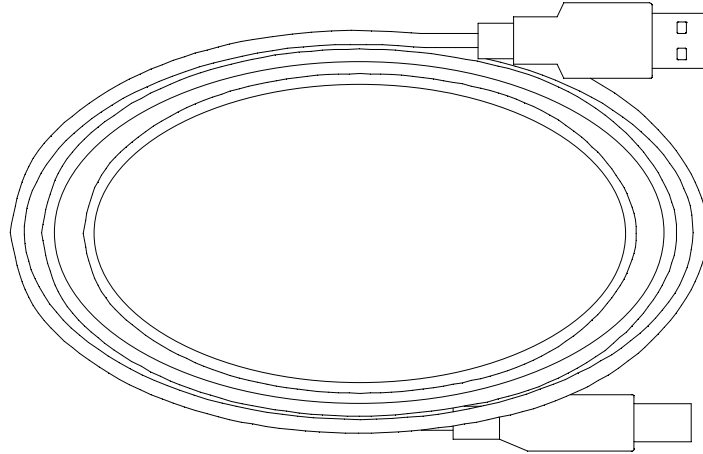

Figure 2: 4-Port AC Adapter

---

## USB Cable

A Type A to Type B USB cable is provided with the docking station. It is only for use with the PC Controlled configuration. It is not used in the Standalone configuration.



**Figure 3: USB Cable**

---

## Air Filter

A cylindrical particle filter with a short length of tubing is supplied with the SDM-03 for installation to the AIR fitting on the back panel. The filter keeps particulate contamination out of the docking station.

---

## Sample Tubing

Three types of sample tubes are included with the docking station. One 3 foot length of 3/16 inch ID polyurethane tubing is provided to connect the regulator on a calibration cylinder to the GAS fitting on the back panel. One 10 foot length of 3/16 inch ID polyurethane tubing is provided for manifolding the GAS fitting. This tubing is only needed in the PC Controlled configuration of the SDM-03. In addition, a 10 foot length of 5/16 inch ID polyurethane tubing is provided for connection to the exhaust fitting on the back panel to allow routing of the exhaust to a location such as an open window where the exhaust can disperse.

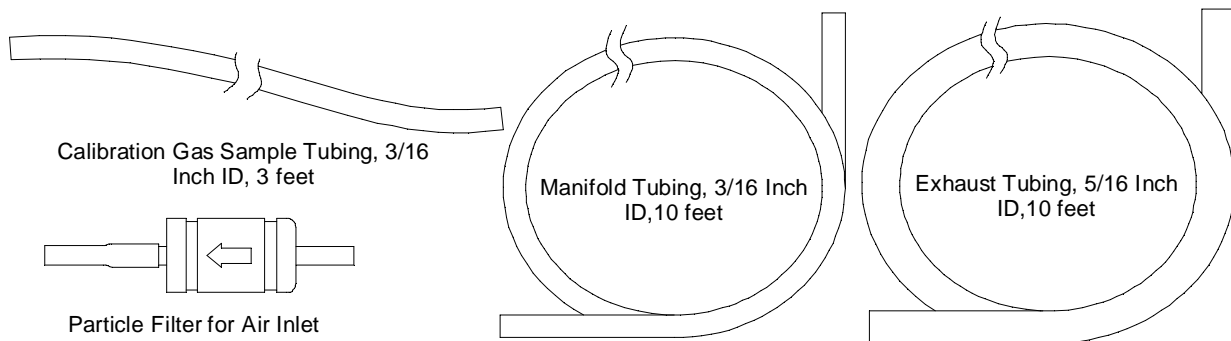

**Figure 4: Air Filter & Sample Tubing**

---

**WARNING:** *Do not use an exhaust tube that is longer than 10 feet. The increased flow restriction caused by a longer tube may affect gas response and cause inaccurate calibration and bump test results.*

---

---

## Check Valve

A check valve is included with the SDM-03 but is not needed for the Standalone configuration. It is used for the PC Controlled configuration.

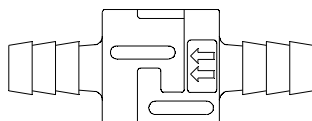
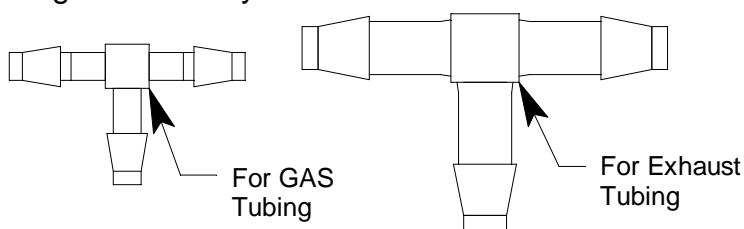

**Figure 5: Check Valve**

---

## T-Fittings

Two T-fittings are included with the SDM-03. The larger fitting is for the exhaust tubing. The smaller fitting is for the GAS tubing. Neither T-fitting is needed for the Standalone configuration. They are used in the PC Controlled configuration.



**Figure 6: T-Fittings**

# Instrument Cradle

The instrument cradle is a recessed area on the top of the SDM-03 that is designed to accept the 03 Series. Insert the 03 Series in the instrument cradle when you perform a bump test or calibration. A spring-loaded cover latches into place to secure the 03 Series. A sample port in the cover matches up with the 03 Series' diffusion port and routes air and calibration gas to the sensor during a bump test or calibration. An infrared (IR) port at the back of the cradle lines up with the 03 Series' IR port when it is inserted in the cradle and is used to communicate with the 03 Series.

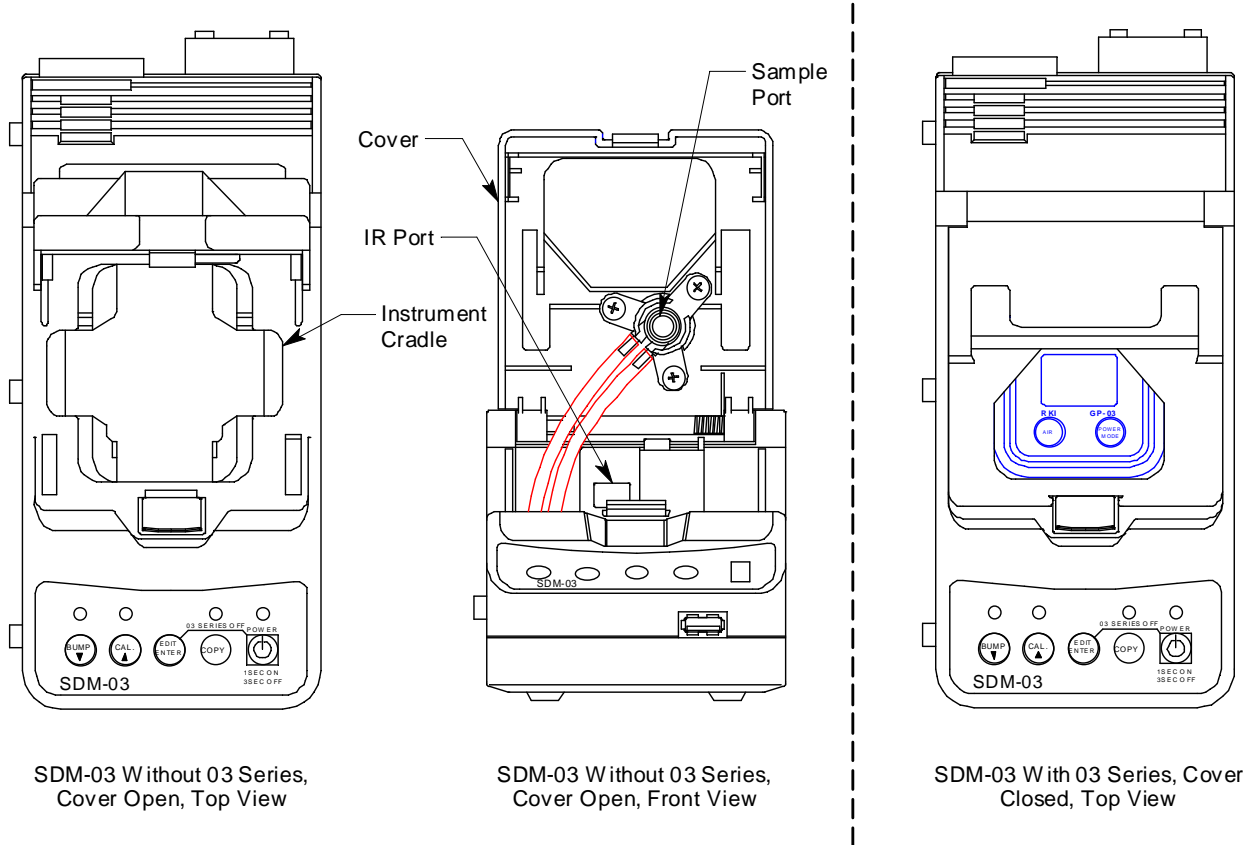
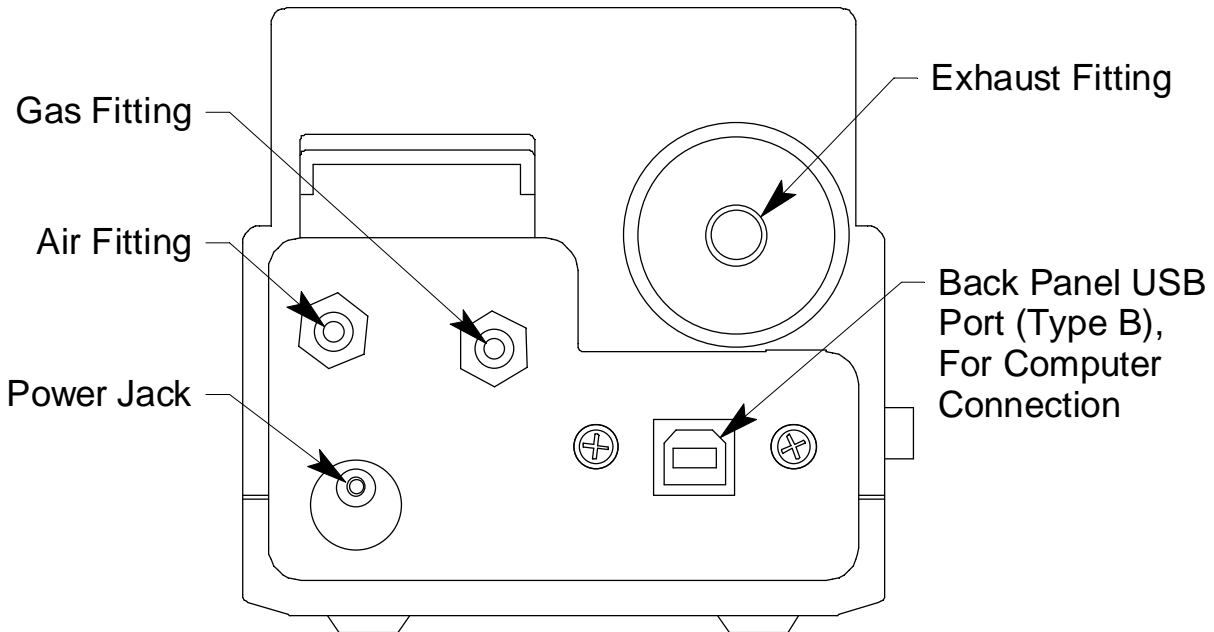

**Figure 7: Instrument Cradle**

---

## Back Panel

The back panel includes the power jack, sample fittings, and a USB PC connector.



**Figure 8: Fittings and Connections**

### Power Jack

The power jack is located in the bottom left corner of the back panel. The plug on the end of the AC adapter cable mates to it.

### Sample Fittings

Two sample fittings are located on the back of the SDM-03. The AIR fitting is in the upper left corner and draws air into the SDM-03. The GAS fitting is to the right of the AIR fitting and is used to connect the SDM-03 to a calibration gas cylinder. Both fittings accept 3/16 inch ID tubing.

An exhaust fitting is located in the upper right corner. It allows routing of the exhausted calibration gas to a convenient location. This fitting accepts 5/16 inch ID tubing. Even though the exhaust gas can be routed to an area to be safely dispersed, the docking station should still be installed in a well ventilated area.

### PC Connection

A type B USB connection is located beneath the exhaust fitting on the SDM-03's back panel. It is only used for the PC Controlled configuration and is not used in the Standalone configuration.

## Control Panel

The control panel is used to setup and operate the docking station in the Standalone configuration. It is located at the front of the docking station. It includes the control buttons, the control button LEDs, and the power LED.

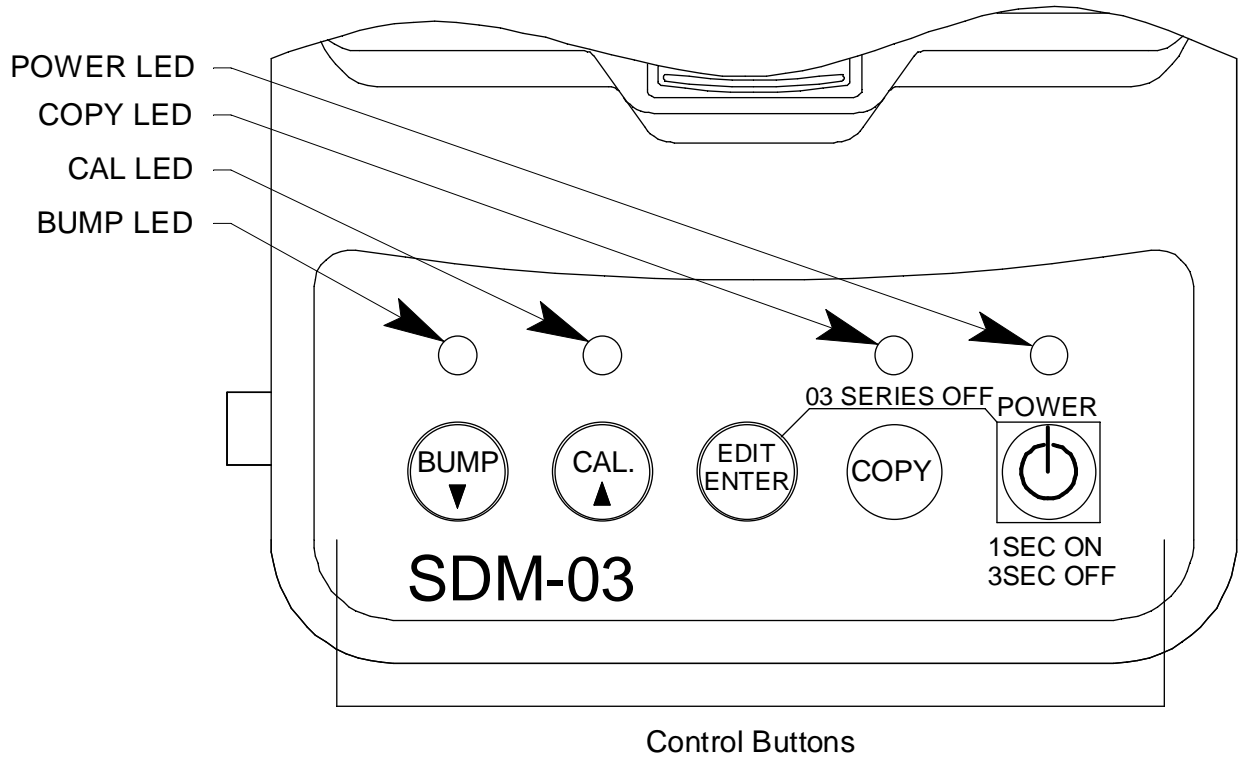

**Figure 9: Control Panel**

Five control buttons are located on the control panel. From left to right they are BUMP ▼, CAL ▲, EDIT ENTER, COPY, and POWER. The BUMP ▼, CAL ▲, and COPY control buttons each have an LED above them that indicates the status of the function controlled by that button. The POWER LED is located above the POWER button and functions as a pilot LED and a system failure LED.

**Table 2: Control Button Functions**

Control Button	Control Button Function(s)	Control Button LED Function(s)
BUMP ▼	<ul style="list-style-type: none"> <li>• Initiates a bump test</li> <li>• Cancels a bump test</li> <li>• Moves down a list of parameters</li> <li>• Decreases an adjustable parameter</li> </ul>	Indicates status of a bump test in progress

**Table 2: Control Button Functions**

<b>Control Button</b>	<b>Control Button Function(s)</b>	<b>Control Button LED Function(s)</b>
CAL ▲	<ul style="list-style-type: none"> <li>• Initiates a calibration</li> <li>• Cancels a calibration</li> <li>• Clears data from docking station memory (when used with COPY button)</li> <li>• Moves up a list of parameters</li> <li>• Increases an adjustable parameter</li> </ul>	Indicates status of a calibration in progress
EDIT ENTER	<ul style="list-style-type: none"> <li>• Puts docking station into various edit modes</li> <li>• Makes a displayed parameter editable</li> <li>• Escapes or cancels an operation</li> <li>• Turns off connected instrument (when used with POWER button)</li> </ul>	n/a
COPY	<ul style="list-style-type: none"> <li>• Copies data to a USB flash drive.</li> <li>• Clears data from docking station memory (when used with CAL ▲ button)</li> </ul>	<ul style="list-style-type: none"> <li>• Indicates amount of docking station memory used</li> <li>• Indicates status of copying function</li> <li>• Indicates the result of a copy operation</li> </ul>
POWER	<ul style="list-style-type: none"> <li>• Turns on the docking station</li> <li>• Turns off the docking station</li> <li>• Turns off connected instrument (when used with EDIT ENTER button)</li> </ul>	n/a



---

## Front Panel

A type A USB port is located on the front of the docking station. This port can be used to save calibration and bump test data to a USB flash drive. This USB port is for use only in the Standalone configuration of the SDM-03.

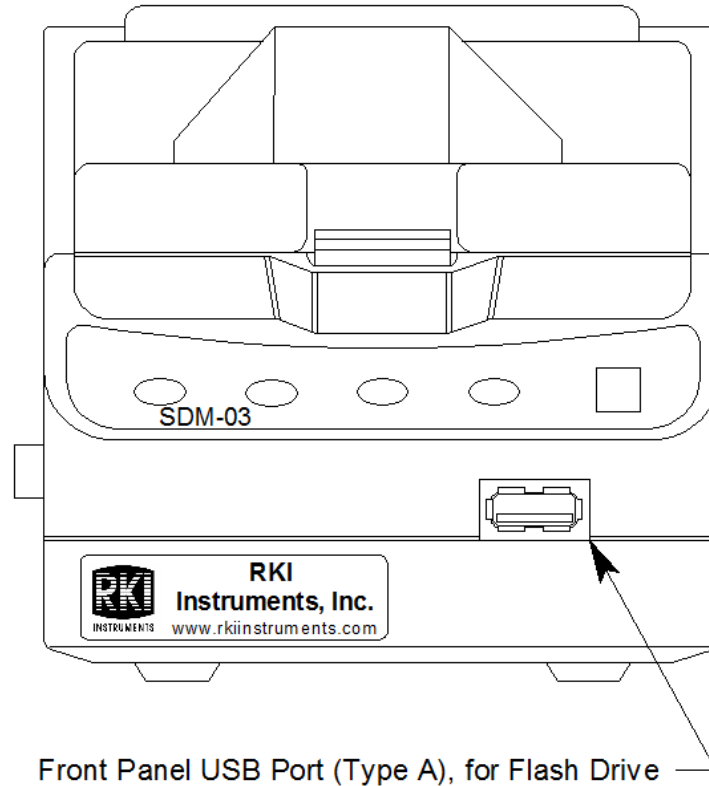

**Figure 10: Front Panel**

---

**NOTE:** The SDM-03 does not support connection of a computer to the front USB port, only a USB flash drive.

---

## Chapter 3: Preparing to Use the SDM-03

---

### Overview

There are four tasks that must be completed before you can begin to use the SDM-03: hardware assembly, setting or confirming the bump test and calibration parameters, connecting calibration gas, and installing the Single Module Data Viewer Software on your computer. This chapter describes how to assemble the parts that are shipped with the SDM-03, how to set or view the bump test and calibration parameters, and how to install the Single Module Data Viewer Software on a Windows based personal computer.

---

### Hardware Assembly

The hardware assembly consists of connecting the AC adapter, installing the air filter, and connecting the sample tubing. Perform the following to complete the hardware assembly:

1. Place the SDM-03 on a convenient table top near an AC wall socket in a well ventilated area. A location near a window that can be opened is best so that the exhaust can be routed to the window.
2. Connect the AC adapter's wall plug into a wall AC socket.
3. Insert the round plug on the end of the AC adapter's cable into the power jack on the back of the SDM-03.

---

**NOTE:** If you have multiple SDM-03s and are using a 4-port AC adapter, plug each of the round plugs on the end of the AC adapter into the power jack on the back of 4 separate SDM-03s.

---

4. Install the air filter so that the arrow on the filter that indicates direction of flow is pointing towards the AIR fitting. Push the open end of the flexible tube that is on one end of the filter onto the AIR fitting on the back of the SDM-03.
5. Install the 10 foot long 5/16 inch ID flexible tube that is included with the SDM-03 onto the exhaust fitting located in the upper right corner of the back panel. Route the tube to an area where the exhaust can be safely dispersed, such as an open window.

---

**CAUTION:** *The maximum recommended length for the exhaust tube is 10 feet. Do not use more than 10 feet of tubing or tubing with an ID of less than 5/16 inch for the exhaust tube or the bump test and calibration accuracy may be adversely affected. The tube that is shipped with the SDM-03 has an ID of 5/16 inch and is 10 feet long.*

---

6. Install the 3 foot long 3/16 inch ID tube that is included with the SDM-03 on the GAS fitting.

## Setting the Operational Parameters in Edit Mode

Once the hardware has been assembled, use Edit Mode to confirm or adjust the bump test and calibration parameters before using the SDM-03.

The bump test parameters define how long fresh air and calibration gas are applied to an instrument during a bump test. They also define the tolerance used in determining whether an instrument fails or passes a bump test and whether or not a calibration automatically takes place if a bump test fails. The calibration parameters define how long fresh air and calibration gas are applied to an instrument during a calibration.

The bump test and calibration parameters are saved in the SDM-03's memory. If a parameter is changed with one particular instrument installed in the SDM-03, the change will be in effect for the bump test or calibration of any subsequent instruments until the parameter is changed again.

### Bump Test & Calibration Parameters

There are four bump test parameters and two calibration parameters. The two calibration parameters, air sample time and calibration gas sample time, are also bump test parameters. The parameters are described below. Table 3 below shows the factory settings for the bump test and calibration parameters. If you wish to use the factory settings, then you do not need to make any parameter adjustments. If you wish to confirm or change the parameter settings, follow the instructions below in "Setting the Bump Test Parameters" on page 19 or "Setting the Calibration Parameters" on page 21.

**Table 3: Bump Test & Calibration Parameter**

Parameter	Display Tag	Available Choices	Bump Factory Setting	Cal Factory Setting
Air Sample Time	AIR--IN	<ul style="list-style-type: none"> <li>• 15 seconds</li> <li>• 30 seconds</li> <li>• 45 seconds</li> <li>• 60 seconds</li> <li>• 90 seconds</li> </ul>	15 seconds	15 seconds
Calibration Gas Sample Time	GAS--IN	<ul style="list-style-type: none"> <li>• 20 seconds</li> <li>• 30 seconds</li> <li>• 45 seconds</li> <li>• 60 seconds</li> <li>• 90 seconds</li> <li>• 120 seconds</li> </ul>	20 seconds	60 seconds
Bump Test Check Tolerance	TOLER	<ul style="list-style-type: none"> <li>• ± 10%</li> <li>• ± 20%</li> <li>• ± 30%</li> <li>• ± 40%</li> <li>• ± 50%</li> </ul>	50%	n/a

**Table 3: Bump Test & Calibration Parameter**

Parameter	Display Tag	Available Choices	Bump Factory Setting	Cal Factory Setting
Automatic Calibration	AUTO--C	<ul style="list-style-type: none"> <li>• On</li> <li>• Off</li> </ul>	On	n/a

***Air Sample Time (AIR--IN)***

The air sample time can be set separately for bump testing and calibration. It is the length of time that the SDM-03 will draw air through the AIR fitting on the back of the docking station. Air is drawn during a bump test or calibration before an air adjust operation and to purge calibration gas from the system after calibration gas has been drawn through the GAS fitting on the back of the docking station.

---

**NOTE:** For the following parameters, the 03 Series' setting takes precedence over the SDM-03's setting as long as the bump test function in the 03 Series is turned on. For example, if the SDM-03's CAL setting is set to OFF but the 03 Series' Calibration After Bump Test Failed setting is set to ON, a calibration will still automatically be started after a failed bump test. If the 03 Series' bump test function is set to off, the 03 Series' bump test settings have no effect and the SDM-03's settings are used.

---

***Calibration Gas Sample Time (GAS--IN)***

The calibration gas sample time can be set separately for bump testing and calibration. It is the length of time that the SDM-03 will draw calibration gas through the GAS fitting on the back of the docking station during a bump test or calibration.

***Bump Test Check Tolerance (TOLER)***

The bump test check tolerance only applies to bump testing. It determines how close the instrument gas reading must be to the calibration gas concentration for each channel during a bump test in order to pass the bump test. It is defined as a percentage of the calibration gas concentration. The amount that the instrument gas reading differs from the calibration gas concentration must be equal to or less than this percentage of the calibration gas concentration. For example, if the tolerance is set to 50%, and the %LEL calibration gas concentration is 50% LEL, then the bump test gas reading for the LEL channel on the instrument must be 50 %LEL ± 25 %LEL.

***Automatic Calibration (AUTO--C)***

Automatic calibration only applies to bump testing. It can be set to on or off. If it is set to on, then the docking station will automatically perform a calibration if a bump test fails.

## Turning on the SDM-03 with an Instrument

Do the following to turn on the SDM-03 and establish a connection with an instrument:

1. Confirm that the AC adapter is connected to the SDM-03 and to an AC wall socket.
2. Press and hold the SDM-03's POWER button. The LEDs will turn amber.
3. When the BUMP ▼ and CAL ▲ LEDs turn off, release the POWER button.
4. The POWER LED will be blinking green if the SDM-03 is operating properly or solid red if there is a system failure and the COPY LED will be steadily on or off. The amount of free memory in the SDM-03 will dictate the condition of the COPY LED (see "Available Memory in the SDM-03" on page 41).
5. Install an instrument into the instrument cradle.
6. Close and secure the SDM-03 cover over the 03 Series.
7. Press and hold the POWER MODE button on the instrument until you hear a beep, then release it. The instrument will begin its power up sequence (see exceptions below in step 8 and step 9). If a successful connection between the instrument and the SDM-03 occurs, the home screen will appear on the instrument display at the end of the startup sequence. The auto calibration value for the sensor will be displayed.

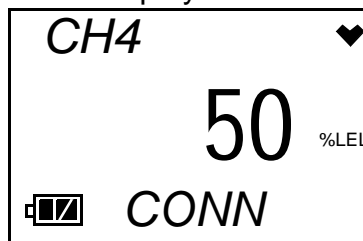

---

**NOTE:** The screen shown above applies to a GP-03 instrument. If you have a different version of the 03 Series, your screen will be slightly different. All screens in this manual show a GP-03 instrument.

---

8. If the instrument's batteries are too drained for standalone operation, the following screen will display.

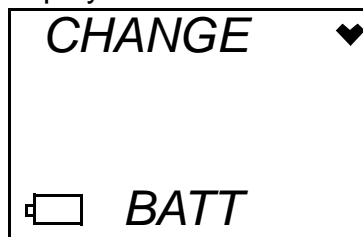

The instrument will not connect to the SDM-03 until the batteries are replaced as described in the GP-03 or OX-03/CO-03/HS-03 Operator's Manual and the instrument is turned back on.

9. There are two exceptions to the sequence described in step 7 above. See the 03 Series User Setup Program Operator's Manual for a description of the **Cal. Limit Display** and **Cal. Limit Check** instrument parameters.
- When **Cal. Limit Display** is set to *On*, if the unit is due for calibration and **Cal. Limit Check** is set to *Confirm to use* (factory setting), then the following screen sequence will occur.

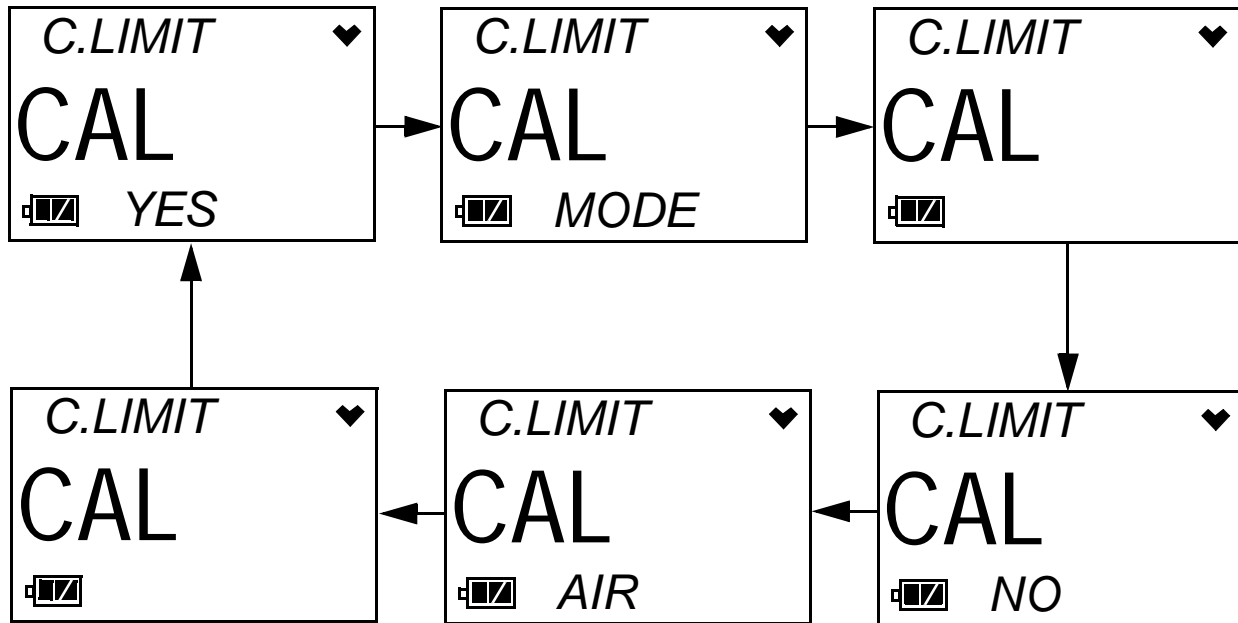

The alarm LED and buzzer will pulse several times. The instrument will then connect to the SDM-03 and display the home screen shown above in step 7.

- When **Cal. Limit Display** is set to *On*, if the unit is due for calibration and **Cal. Limit Check** is set to *Can't use*, then the following screen sequence will occur.

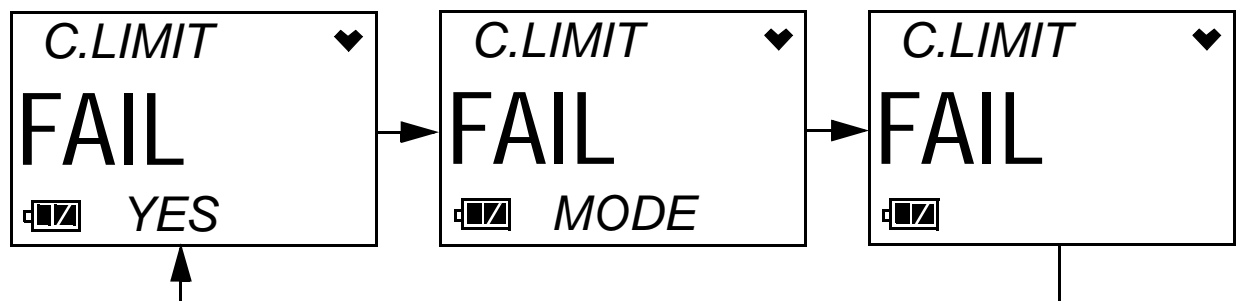

The alarm LED and buzzer will pulse several times. The instrument will then connect to the SDM-03 and display the home screen shown above in step 7.

## Setting the Bump Test Parameters

See “Bump Test & Calibration Parameters” on page 15 for a description of the bump test parameters. Do the following to set the bump test parameters.

1. Turn on the SDM-03 with an instrument and establish a connection between them as described above in "Turning on the SDM-03 with an Instrument". The instrument will display the home screen.

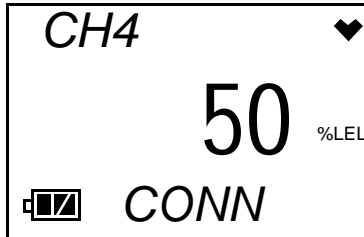

2. Press and hold the EDIT ENTER button for 2 seconds. The instrument will display the Edit Mode screen.

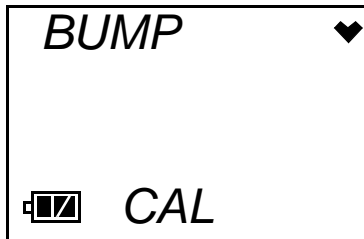

3. Press and release the BUMP ▼ button. The instrument will display the AIR--IN parameter screen. The BUMP ▼ LED will turn green.

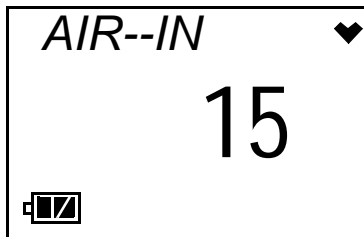

- Use the BUMP ▼ and CAL ▲ buttons to scroll through the different bump test parameters. Do not scroll past the AUTO--C parameter until you have finished making any desired changes.

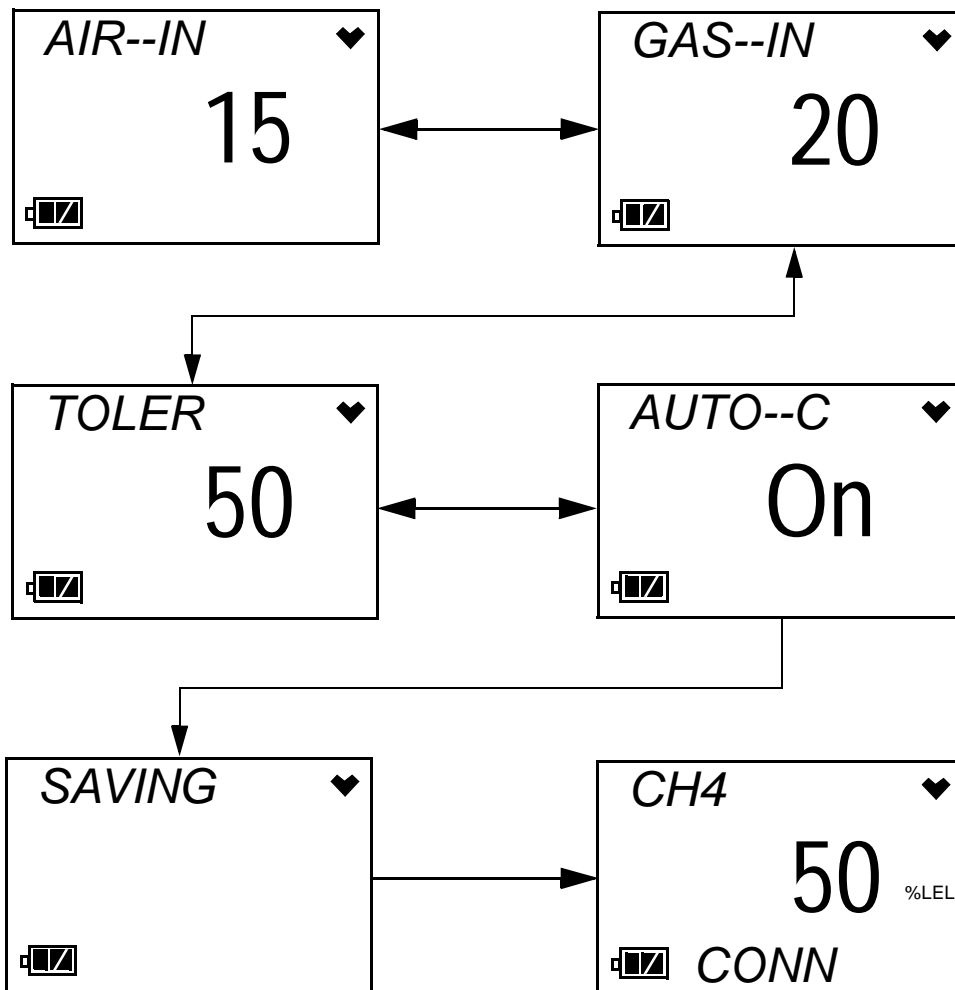

- To edit a parameter, press and release the EDIT ENTER button when that parameter is displayed. An “E” will appear on the bottom of the LCD indicating that the parameter value can be changed. In the example below, the AIR--IN parameter has been selected for updating.

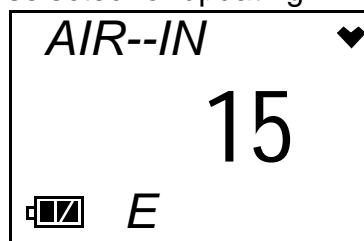

- Use the BUMP ▼ and CAL ▲ buttons to set the parameter to the desired value, then press and release the EDIT ENTER button. The “E” to the right of parameter name will disappear.
- Repeat step 5 - step 6 to set any other parameters.



- When you are done setting the parameters, use the BUMP ▼ button to scroll past the AUTO--C parameter screen. The screen will indicate that the parameter changes have been saved.

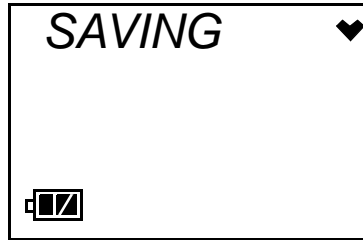

The instrument will return to the home screen.

## Setting the Calibration Parameters

See "Bump Test & Calibration Parameters" on page 15 for a description of the calibration parameters. Do the following to set the calibration parameters.

- Turn on the SDM-03 with an instrument and establish a connection between them as described above in "Turning on the SDM-03 with an Instrument". The instrument will display the home screen.

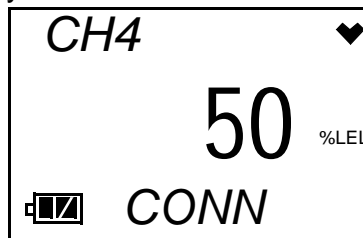

- Press and hold the EDIT ENTER button for 2 seconds. The instrument will display the Edit Mode screen.

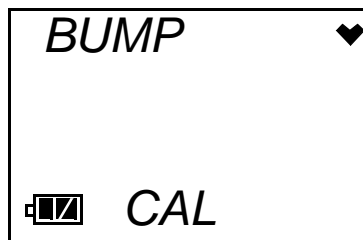

- Press and release the CAL ▲ button. The AIR--IN parameter will be displayed. It is the first of two calibration parameters that can be changed.

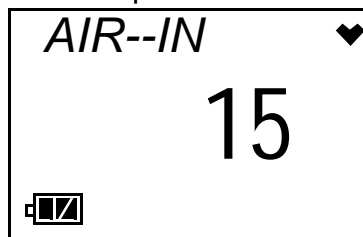

- Use the BUMP ▼ and CAL ▲ buttons to scroll through the different calibration parameters. Do not scroll past the GAS--IN parameter until you have finished making any desired changes.

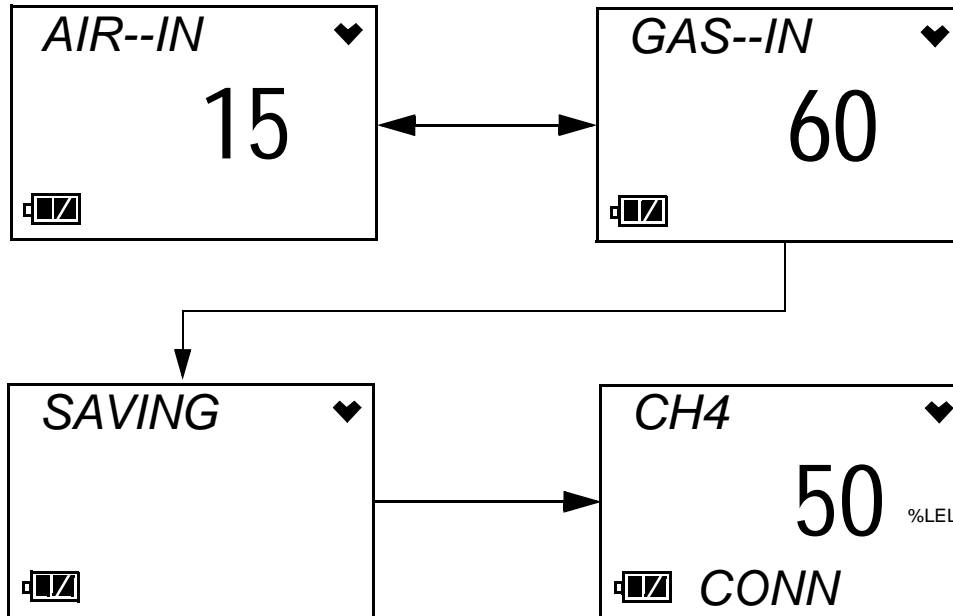

- To edit a parameter, press and release the EDIT ENTER button when that parameter is displayed. An “E” will appear on the bottom of the LCD indicating that the parameter value can be changed. In the example below, the AIR--IN parameter has been selected for updating.

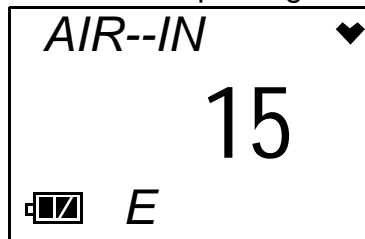

- Use the BUMP ▼ and CAL ▲ buttons to set the parameter to the desired value, then press and release the EDIT ENTER button. The “E” to the right of parameter name will disappear.
- Repeat step 5 - step 6 to set any other parameters.
- When you are done setting the parameters, use the BUMP ▼ button to scroll past the GAS--IN parameter screen. The screen will indicate that the parameter changes have been saved.

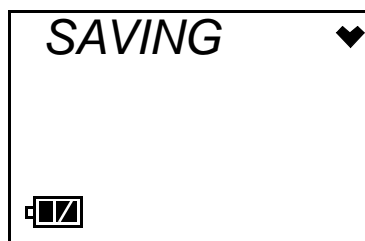

The instrument will return to the home screen.

---

## Connecting Calibration Gas

The GAS fitting on the back of the docking station is designed to be used with a calibration gas cylinder that is fitted with a demand flow regulator. The AIR fitting may be used with a demand flow regulator and a cylinder of zero emissions air, but this is not normally necessary since the docking station will generally be in a fresh air area.

The type of calibration gas cylinder used depends on the version of the 03 Series being used with the calibration station. Use Table 4 below as a guide in determining which calibration gas cylinder is appropriate for your system. See "Spare Parts List" on page 55 for a list of available cylinder part numbers.

**Table 4: Recommended Gas Cylinders**

Typical Instrument Types	Recommended Calibration Gas Cylinder
GP-03	50% LEL CH <sub>4</sub>
OX-03	100% N <sub>2</sub>
CO-03	50 ppm CO
HS-03	25.0 ppm H <sub>2</sub> S

To connect calibration gas to the SDM-03, do the following:

1. If the area around the docking station is not considered a fresh air area (an area free of combustible and toxic gases and of normal oxygen content, 20.9%) install a tube not longer than 10 feet on the filter attached to the AIR fitting on the back of the docking station and route it to a fresh air area or connect a cylinder of zero air with a demand flow regulator to the AIR fitting.
2. Install the demand flow regulator on the calibration gas cylinder.
3. Connect the demand flow regulator to the GAS fitting using the 3 foot length of 3/16 inch ID sample tubing provided with the docking station.

---

## Installing the Single Module Data Viewer Software

1. Launch Windows®.
2. Exit from all applications and open windows.
3. Insert the SDM-GX Product CD into your computer's CD-ROM drive. The CD will automatically open revealing several folders. Open the Single Module Data Viewer Software folder, double click on setup.exe.
4. The Single Module Data Viewer InstallShield Wizard comes up to guide you through installation. Click **Next** to proceed to the License Agreement window.
5. Read the license agreement and click the agreement acceptance selection box, then click **Next** to proceed to the Customer Information window.
6. Enter a user name and organization and select if you want to install the program for all users on the computer or just for your user account, then click **Next** to proceed to the Destination Folder window.
7. The default installation folder (C:\Program Files\Single Module Data Viewer\ ) is displayed. If you want to install the software in the default folder continue with step 8. If you want to install the software in a different location, click **Change** and choose a new installation folder now and then continue with step 8.
8. Click **Next** to proceed to the Ready to Install the Program window.
9. Review the installation settings. If they are OK, click **Install** and the installation process will begin. If you want to change installation settings, click **Back** and change them to the desired settings.
10. During software installation, the installation program may find newer versions of Windows files on your computer than those in the Installation CD. If this happens, the installation software will ask you if you want to keep these newer files. Click **Yes** to do so.
11. Follow the on-screen instructions to complete software installation.

# Chapter 4: Operation

---

## Overview

When you have completed the tasks in "Chapter 3: Preparing to Use the SDM-03", you are ready to use the SDM-03 docking station. The SDM-03 is capable of performing bump tests and calibrations on the 03 Series. This chapter describes procedures for using the docking station to bump test and calibrate instruments in the standalone configuration of the docking station. It also describes the information that is saved in the docking station's memory and how to save that information to a USB flash drive for use with the Single Module Data Viewer Program.

---

## Bump Testing an 03 Series

When a bump test is performed, the SDM-03 performs a fresh air adjustment on an 03 Series and then applies calibration gas to the instrument. The docking station then analyzes the response results based on criteria defined by the bump test check tolerance parameter and determines if the instrument passed the bump test. The bump test check tolerance is defined in "Bump Test Check Tolerance (TOLER)" on page 16. If the automatic calibration parameter is set to ON, then the SDM-03 will automatically perform a calibration if the bump test fails. The screens in this section show a GP-03 but the instructions apply to all versions of the 03 Series.

Do the following to perform a bump test on an 03 Series:

1. Confirm that the AC Adapter is connected to the SDM-03 and to an AC wall socket.
2. Press and hold the SDM-03's POWER button. The LEDs will turn amber.
3. When the BUMP ▼ and CAL ▲ LEDs turn off, release the POWER button.
4. The POWER LED will be blinking green if the SDM-03 is operating properly or solid red if there is a system failure and the COPY LED will be off or on steadily. The amount of free memory in the SDM-03 will dictate the condition of the COPY LED (see "Available Memory in the SDM-03" on page 41).
5. Install an 03 Series in the instrument cradle.
6. Close and secure the SDM-03 cover over the 03 Series.

7. Press and hold the POWER MODE button on the 03 Series until you hear a beep, then release it. The 03 Series will begin its power up sequence (see exceptions below in step 8 and step 9). If a successful connection between the instrument and the SDM-03 occurs, the home screen will appear on the instrument display at the end of the startup sequence. The auto calibration value will be displayed.

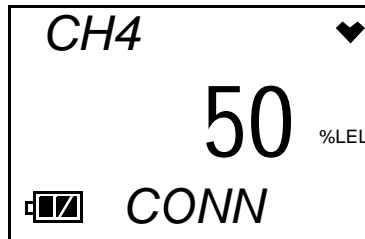

---

**NOTE:** The screen shown above applies to a GP-03 instrument. If you have a different version of the 03 Series, your screen will be slightly different. All screens in this manual show a GP-03 instrument.

---

8. If the instrument's batteries are too drained for standalone operation, the following screen will display.

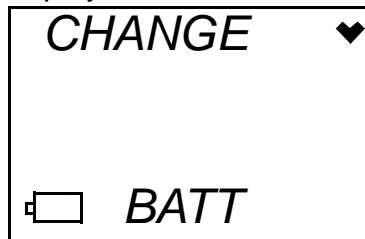

The instrument will not connect to the SDM-03 until the batteries are replaced as described in the GP-03 or OX-03/CO-03/HS-03 Operator's Manual and the instrument is turned back on.

9. There are two exceptions to the sequence described in step 7 above. See the 03 Series User Setup Program Operator's Manual for a description of the **Cal. Limit Display** and **Cal. Limit Check** instrument parameters.

- When **Cal. Limit Display** is set to *On*, if the unit is due for calibration and **Cal. Limit Check** is set to *Confirm to use* (factory setting), then the following screen sequence will occur.

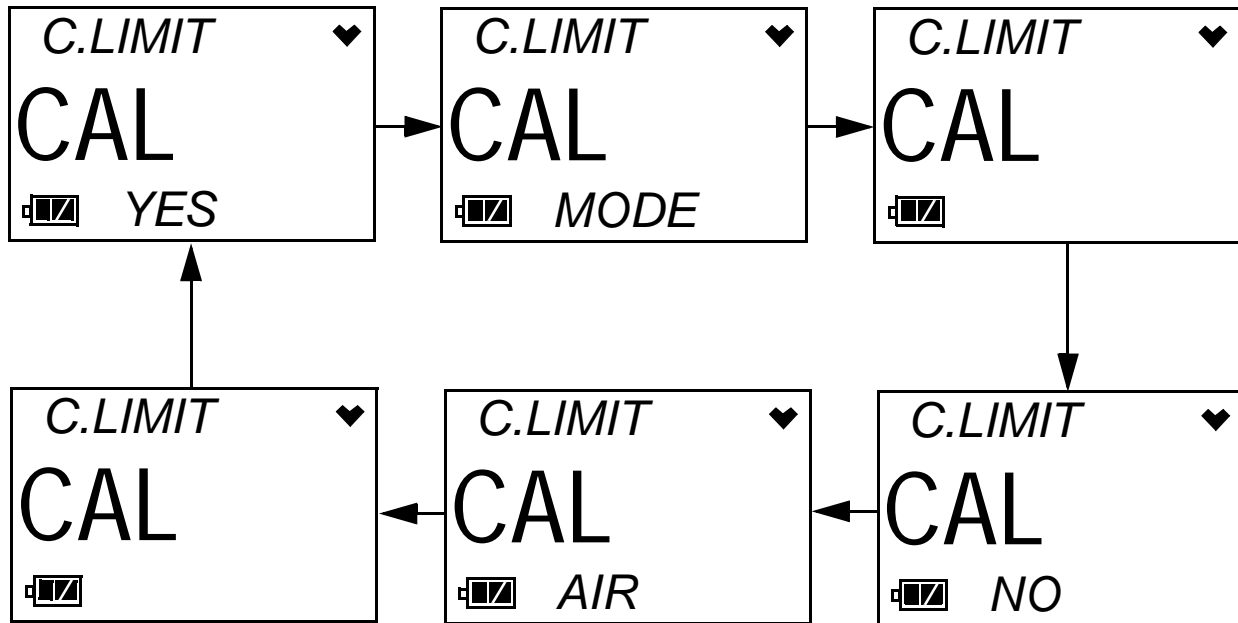

The alarm LED and buzzer will pulse several times. The instrument will then connect to the SDM-03 and display the home screen shown above in step 7.

- When **Cal. Limit Display** is set to *On*, if the unit is due for calibration and if **Cal. Limit Check** is set to *Can't use*, then the following screen sequence will occur.

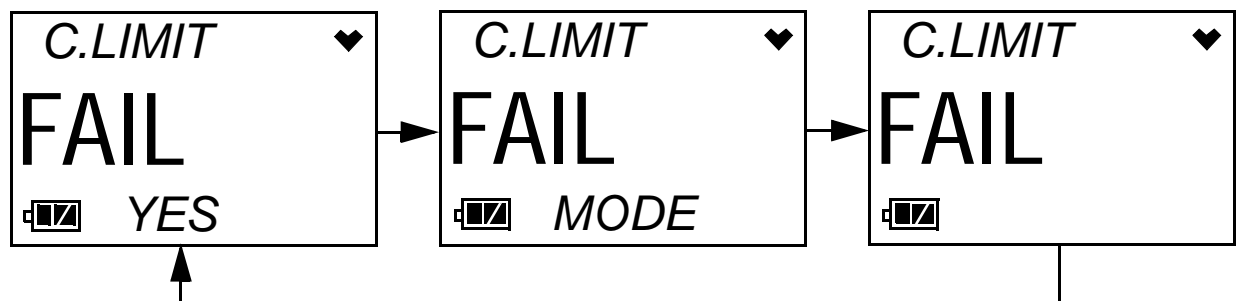

The alarm LED and buzzer will pulse several times. The instrument will then connect to the SDM-03 and display the home screen shown above in step 7.

10. If necessary, confirm that the bump test check tolerance is set to the desired value. See "Setting the Bump Test Parameters" on page 19.

11. Verify that the appropriate calibration gas cylinder is connected to the GAS fitting on the back of the SDM-03. See “Connecting Calibration Gas” on page 23 for calibration gas connection procedures.
12. Press and hold the BUMP ▼ button until the BUMP ▼ LED turns on (about one second) then release it. During the bump test, the BUMP ▼ LED will flash amber indicating that a bump test is in progress.

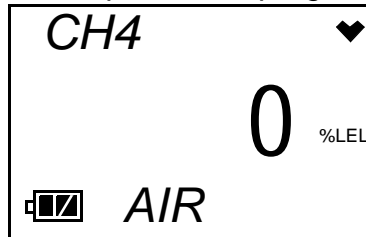

If you wish to cancel the bump test, press and hold the BUMP ▼ button for at least one second until CANC appears on the screen.

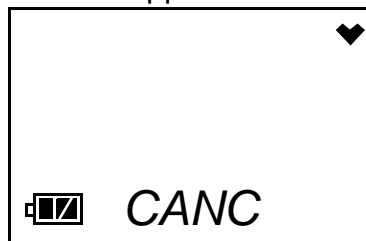

13. If at any point during the bump test the gas flow to the instrument becomes too low, the bump test will be aborted and the screen will indicate a flow failure.

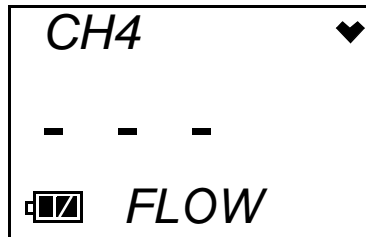

If a flow failure occurs, confirm all tubing connections are correct and that all lines are clear.

- To return to the home screen, press and hold the EDIT ENTER button for about 3 seconds.
  - To start another bump test, press and release the BUMP ▼ button.
  - To perform a calibration, press and release the CAL ▲ button.
14. The SDM-03 will begin the bump test by applying fresh air to the instrument for the time defined by the AIR--IN bump test parameter.
  15. The SDM-03 will perform a fresh air adjustment on the instrument.
    - If the air adjustment is successful, the SDM-03 will continue as described in step 16 below.
    - If the air adjustment is not successful, the SDM-03 will abort the bump test



and will not apply calibration gas. If this happens, the BUMP ▼ LED will flash red indicating a failure and the following screens will alternate indicating the fresh air reading and the failed air adjustment.

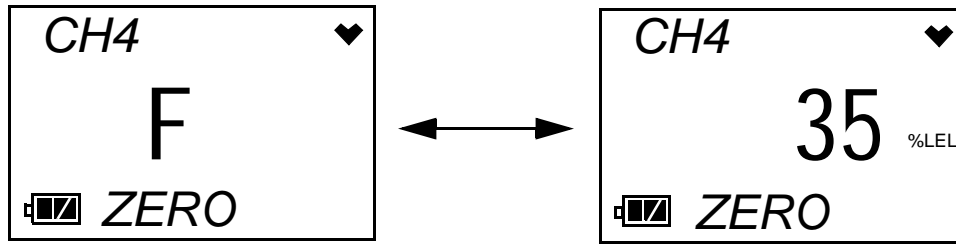

**Figure 11: Failed Fresh Air Adjustment**

In this case, continue with step 20.

16. The SDM-03 will apply calibration gas to the instrument for the time defined by the GAS--IN bump test parameter.

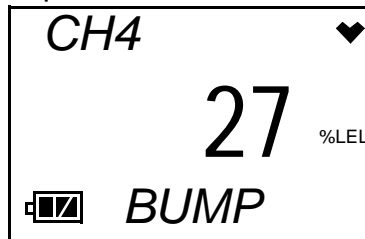

17. The SDM-03 will analyze the results.
  - If the bump test passes, continue with step 18.
  - If the bump test fails, and AUTO--C is set to OFF, continue with step 18.
  - If the bump test fails, and AUTO--C is set to ON, a calibration will automatically begin and calibration gas will continue to flow. The CAL ▲ LED will begin to flash amber.

---

**NOTE:** Calibration gas will continue to be applied so that the total gas application time is the time defined by the GAS--IN calibration parameter. This time includes the time that the instrument was being bump tested. If the GAS--IN **calibration parameter** is set to 90 seconds and the GAS--IN **bump test parameter** is set to 30 seconds, the instrument will sample gas for an additional 60 seconds if the bump test fails to bring the total exposure time to 90 seconds.

---

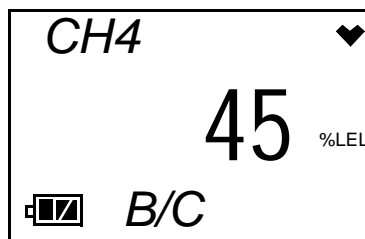

At the end of the calibration gas application, the SDM-03 will analyze the results. See “Using the Single Module Data Viewer Program” on page 45 for a description of calibration results.

18. The SDM-03 will then purge the system with fresh air for the time defined by the AIR--IN bump test parameter.



19. After the fresh air purge is complete, the 03 Series screen will alternate between the gas reading and the bump test or bump test and calibration result. For a successful bump test, the gas reading at the end of the gas application will be displayed. For a successful automatic calibration, the auto calibration value will be displayed. For a failed bump test or automatic calibration, the gas reading at the end of the gas application will be displayed. If the instrument passed the bump test, the BUMP ▼ LED will turn solid green. If the instrument failed the bump test, the BUMP ▼ LED will turn solid red. If the instrument passed the automatic calibration, the CAL ▲ LED will turn solid green. If the instrument failed the automatic calibration, the CAL ▲ LED will turn solid red.

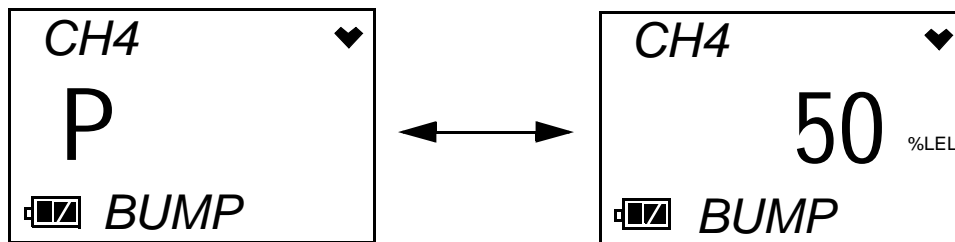

Figure 12: Screen Indication for Passed Bump Test

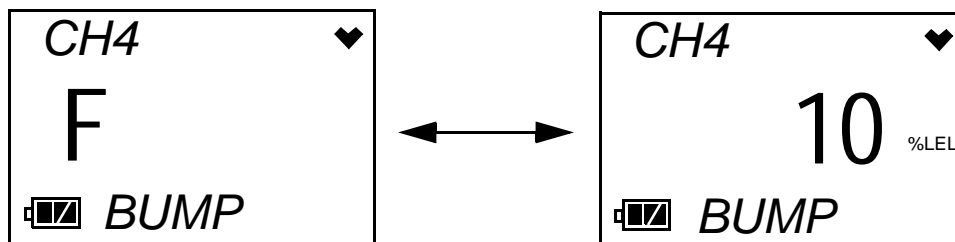
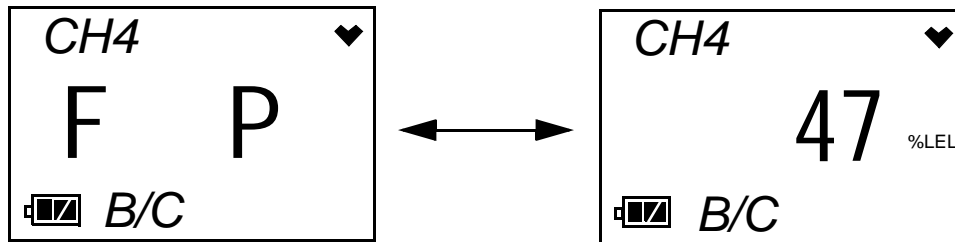
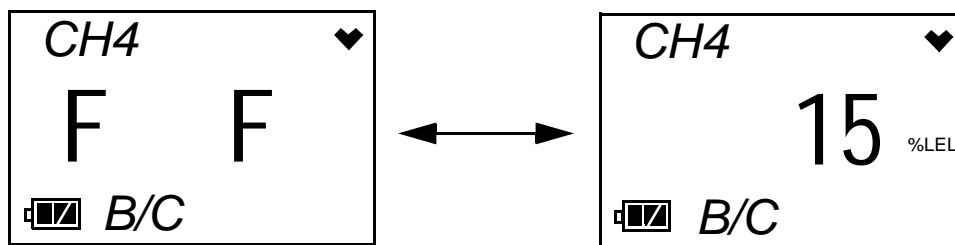

Figure 13: Screen Indication for Failed Bump Test, CAL OFF



**Figure 14: Screen Indication for Failed Bump Test and Passed Automatic Calibration**



**Figure 15: Screen Indication for Failed Bump Test and Failed Calibration**

20. After a successful or failed bump test,

- To perform any other operations:

To perform another bump test, press and hold the BUMP ▼ button until the pump starts. To perform a calibration, press and hold the CAL ▲ button until the pump starts. To return to the home screen, press and hold the EDIT ENTER button until the home screen appears.

- To turn the 03 Series off:

If the bump test was successful, the instrument will shut off after 15 seconds. If the bump test failed, the instrument will shut off after 10 minutes. If buttons are pressed before the SDM-03 turns off the instrument, it will automatically turn it off 10 minutes after the last button push.

To turn off the instrument before it is automatically turned off, press and hold the EDIT ENTER and POWER buttons simultaneously for about one second and then release them when the instrument turns off. To avoid accidentally entering Edit Mode, press and hold the POWER button first, then press and hold the EDIT ENTER button.

---

**CAUTION:** *When using the 03 Series with the SDM-03, do not turn off the instrument using the instrument power button. Use the EDIT ENTER and POWER buttons on the SDM-03 to turn off the instrument.*

---

The BUMP ▼ or BUMP ▼ and CAL ▲ LEDs will remain on indicating the test results. If the same 03 Series is turned on again, the test results will still be indicated by the BUMP ▼ or BUMP ▼ and CAL ▲ LEDs and on the 03 Series screen. To clear the BUMP ▼ or BUMP ▼ and CAL ▲ LEDs, with the 03 Series on, press and hold the EDIT ENTER button for about 3 seconds until the display returns to the home screen. If a new 03 Series is turned on and connected, the results displayed by the BUMP ▼ or BUMP ▼ and CAL ▲ LEDs will automatically be cleared.

21. The results of the bump test or bump test and calibration will be stored in the SDM-03's memory and will be available to copy to a USB flash drive. See "Copying Calibration and Bump Test Records to a USB Flash Drive" on page 41 for instructions to copy the saved bump test and calibration records to a USB flash drive.
22. Remove the 03 Series from the SDM-03.
23. If you wish to bump test additional instruments, repeat step 5 - step 22 above for each additional instrument.

---

## Calibrating an 03 Series

When a calibration is performed, the docking station performs a fresh air adjustment on an instrument and then applies calibration gas to the instrument. The docking station analyzes the calibration results and determines if the instrument passed the calibration. The screens in this section show a GP-03 but the instructions apply to all versions of the 03 Series.

To perform a calibration on an 03 Series:

1. Confirm that the AC adapter is connected to the SDM-03 and to an AC wall socket.
2. Press and hold the SDM-03's POWER button. The LEDs will turn amber.
3. When the BUMP ▼ and CAL ▲ LEDs turn off, release the POWER button.
4. The POWER LED will be blinking green if the SDM-03 is operating properly or solid red if there is a system failure and the COPY LED will be off or on steadily. The amount of free memory in the SDM-03 will dictate the condition of the COPY LED (see "Available Memory in the SDM-03" on page 41).
5. Install an 03 Series in the instrument cradle.
6. Close and secure the SDM-03 cover over the 03 Series.
7. Press and hold the POWER MODE button on the 03 Series until you hear a beep, then release it. The 03 Series will begin its power up sequence (see exceptions below in step 8 and step 9). If a successful connection between the instrument and the SDM-03 occurs, the home screen will appear on the instrument display at the end of the startup sequence. The auto calibration value will be displayed.

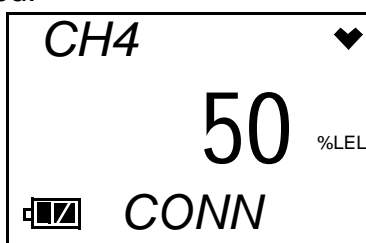

---

**NOTE:** The screen shown above applies to a GP-03 instrument. If you have a different version of the 03 Series, your screen will be slightly different. All screens in this manual show a GP-03 instrument.

---

8. If the instrument's batteries are too drained for standalone operation, the following screen will display.

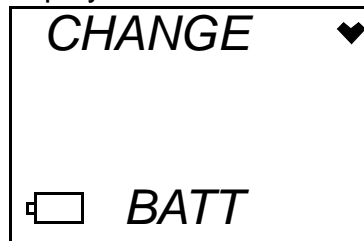

The instrument will not connect to the SDM-03 until the batteries are replaced as described in the GP-03 or OX-03/CO-03/HS-03 Operator's Manual and the instrument is turned back on.

9. There are two exceptions to the sequence described in step 7 above. See the 03 Series User Setup Program Operator's Manual for a description of the **Cal. Limit Display** and **Cal. Limit Check** instrument parameters.
  - When **Cal. Limit Display** is set to *On*, if the unit is due for calibration and **Cal. Limit Check** is set to *Confirm to use* (factory setting), then the following screen sequence will occur.

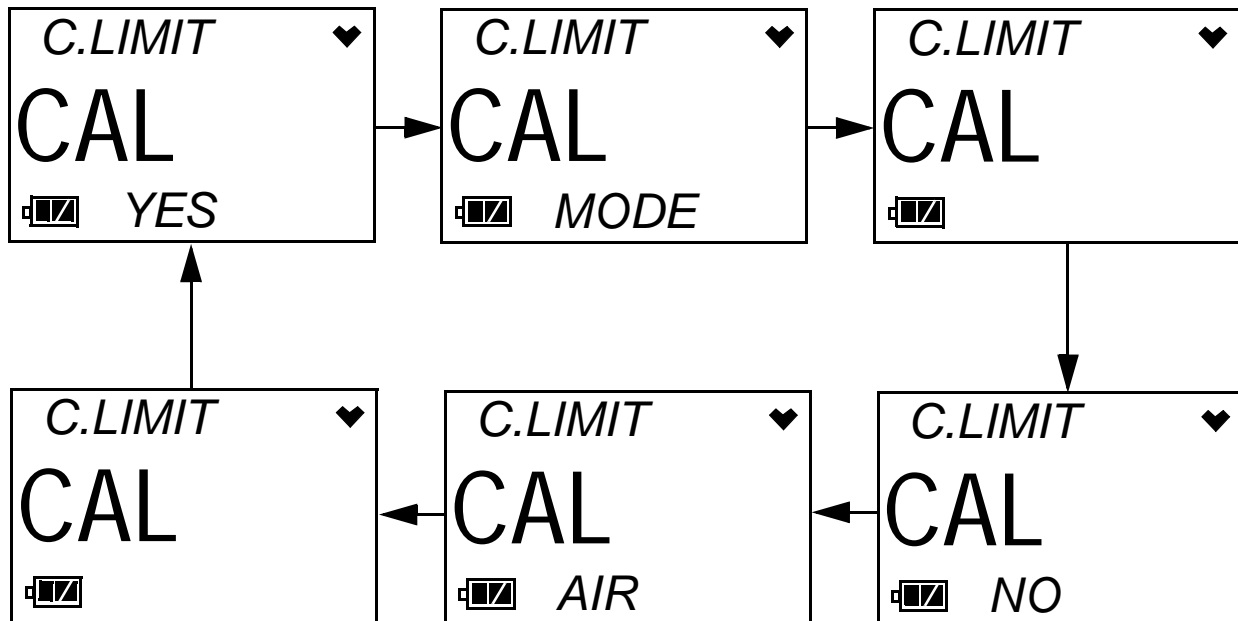

The alarm LED and buzzer will pulse several times. The instrument will then connect to the SDM-03 and display the home screen shown above in step 7.

- When **Cal. Limit Display** is set to *On*, if the unit is due for calibration and if **Cal. Limit Check** is set to *Can't use*, then the following screen sequence will occur.

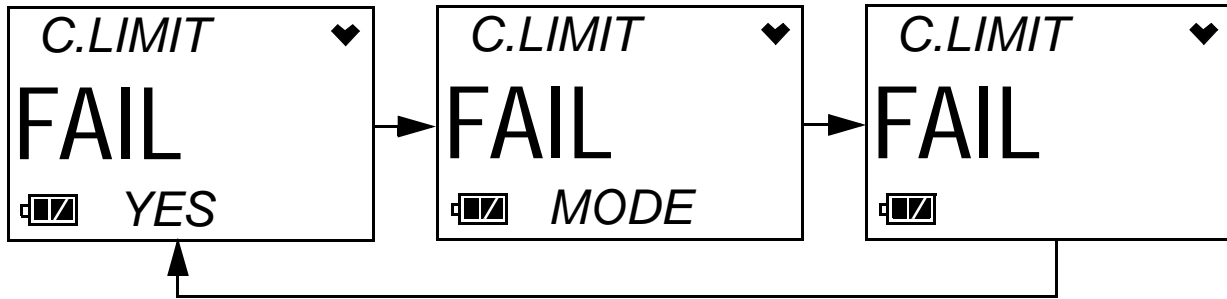

The alarm LED and buzzer will pulse several times. The instrument will then connect to the SDM-03 and display the home screen shown above in step 7.

- Verify that the appropriate calibration gas cylinder is connected to the GAS fitting on the back of the SDM-03. See “Connecting Calibration Gas” on page 23 for calibration gas connection procedures.
- Press and hold the CAL ▲ button until the CAL ▲ LED turns on (about one second) then release it. During the calibration, the CAL ▲ LED will flash amber indicating that a calibration is in progress.

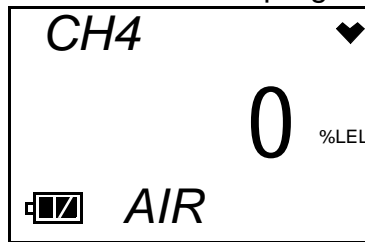

If you wish to cancel the calibration, press and hold the CAL ▲ button for at least one second until CANC appears on the screen.

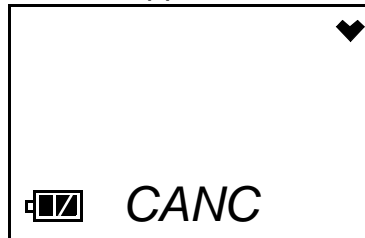

12. If at any point during the calibration the gas flow to the instrument becomes too low, the calibration will be aborted and the screen will indicate a flow failure.

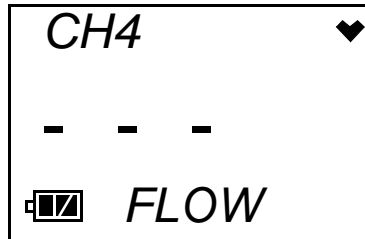

If a flow failure occurs, confirm all tubing connections are correct and that all lines are clear.

- To return to the home screen, press and hold the EDIT ENTER button for about 3 seconds.
  - To start another calibration, press and release the CAL ▲ button.
  - To perform a bump test, press and release the BUMP ▼ button.
13. The SDM-03 begins the calibration by applying fresh air to the instrument for the time defined by the AIR--IN calibration parameter.
14. The SDM-03 will perform a fresh air adjustment on the instrument.
- If the air adjustment is successful, the SDM-03 will continue as described in step 15 below.
  - If the sensor fails the fresh air adjustment, the SDM-03 will abort the calibration and will not apply calibration gas. If this happens, the CAL ▲ LED will flash red indicating a failure and the following screens will alternate indicating the fresh air reading and the failed air adjustment.

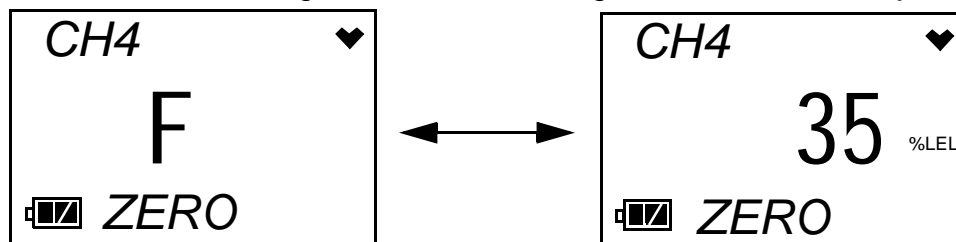

**Figure 16: Failed Fresh Air Adjustment**

In this case continue with step 18.

15. The SDM-03 will apply calibration gas to the instrument for the time defined by the GAS--IN calibration parameter.

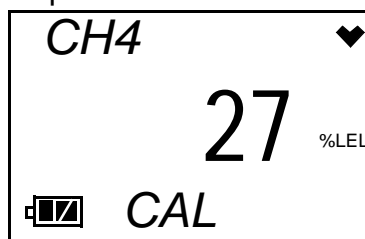



16. The SDM-03 will then purge the system with fresh air for the time defined by the AIR--IN calibration parameter.



17. After the fresh air purge is complete, the screen will alternate between the gas reading and the calibration result. If the calibration passed, the auto calibration value will be displayed. If the calibration failed, the gas reading at the end of the gas application will be displayed. The calibration result is indicated with a P (pass) or an F (fail). The CAL ▲ LED will stop blinking and be steadily green if the calibration passed or steadily red if the calibration failed.

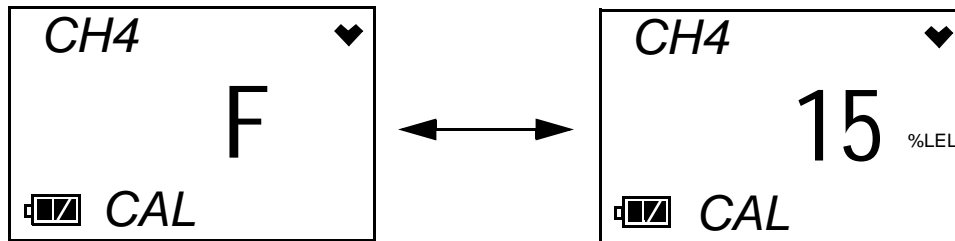

**Figure 17: Calibration Results**

18. After a successful or failed calibration,

- To perform any other operations:

To perform a bump test, press and hold the BUMP ▼ button until the pump starts. To perform another calibration, press and hold the CAL ▲ button until the pump starts. To return to the home screen, press and hold the EDIT ENTER button until the home screen appears.

- To turn the 03 Series off:

If the calibration was successful, the instrument will shut off after 15 seconds. If the calibration failed, the instrument will shut off after 10 minutes. If buttons are pressed before the SDM-03 turns off the instrument, it will automatically turn it off 10 minutes after the last button push.

To turn off the instrument before it is automatically turned off, press and hold the EDIT ENTER and POWER buttons simultaneously for about one second and then release them. To avoid accidentally entering Edit Mode, press and hold the POWER button first, then press and hold the EDIT ENTER button.

---

**CAUTION:** *When using the 03 Series with the SDM-03, do not turn off the instrument using the instrument power button. Use the EDIT ENTER and POWER buttons on the SDM-03 to turn off the instrument.*

---

The CAL ▲ LED will remain on indicating the test results. If the same 03 Series is turned on again, the test results will still be indicated by the CAL ▲ LED and on the 03 Series screen. To clear the CAL ▲ LED, with the 03 Series on, press and hold the EDIT ENTER button for about 3 seconds until the display returns to the home screen. If a new 03 Series is turned on and connected, the results displayed by the CAL ▲ LED will automatically be cleared.

19. The results of the calibration will be stored in the SDM-03's memory and will be available to copy to a USB flash drive. See "Copying Calibration and Bump Test Records to a USB Flash Drive" on page 41 for instructions to copy the saved bump test and calibration records to a USB flash drive.
20. Remove the 03 Series from the SDM-03.
21. If you wish to calibrate additional instruments, repeat step 5 - step 20 above for each additional instrument.

# Troubleshooting

**NOTE:** This troubleshooting guide describes SDM-03 problems only. See the GP-03 or OX-03/CO-03/HS-03 Operator's Manual for problems you may encounter with the instrument.

**Table 5: Troubleshooting the SDM-03**

Symptoms	Probable Causes	Recommended Action
<ul style="list-style-type: none"> <li>Fresh air adjustment fails</li> </ul>	<ul style="list-style-type: none"> <li>The SDM-03 is not in a fresh air environment or the cylinder being used is not a zero air cylinder.</li> <li>If a zero air cylinder is used, the calibration cylinder is out of gas.</li> <li>If a zero air cylinder is used, the tubing from the regulator to the AIR fitting is not connected.</li> </ul>	<ol style="list-style-type: none"> <li>Confirm that the SDM-03 is in a fresh air environment or that a zero air cylinder is attached to the AIR fitting.</li> <li>If a zero air cylinder is used, verify that it contains an adequate supply of test sample.</li> <li>If a zero air cylinder is used, check all calibration tubing for leaks or for any bad connections.</li> <li>If the fail condition continues, replace the sensor in the instrument.</li> <li>If the difficulties continue, contact RKI Instruments, Inc. for further instruction.</li> </ol>
<ul style="list-style-type: none"> <li>Calibration fails</li> </ul>	<ul style="list-style-type: none"> <li>The auto calibration values do not match the cylinder gas concentrations.</li> <li>The calibration cylinder is out of gas or is outdated.</li> <li>The calibration cylinder is not connected to the GAS fitting.</li> <li>The instrument is not properly inserted in the instrument cradle.</li> <li>The SDM-03 cover is not closed and secured.</li> <li>The tubing from the regulator to the GAS fitting is not connected.</li> </ul>	<ol style="list-style-type: none"> <li>Confirm that the auto calibration values match the concentrations listed on the gas cylinder.</li> <li>Verify that the calibration cylinder contains an adequate supply of fresh test sample.</li> <li>Verify that the calibration cylinder is connected to the GAS fitting.</li> <li>Check to make sure the instrument is properly inserted in the instrument cradle.</li> <li>Check to make sure the SDM-03 cover is closed and secured.</li> <li>Check all calibration tubing for leaks or for any bad connections.</li> <li>If the fail condition continues, replace the sensor in the instrument.</li> <li>If the difficulties continue, contact RKI Instruments, Inc. for further instruction.</li> </ol>

<ul style="list-style-type: none"> <li>• No IR connection between instrument and SDM-03</li> </ul>	<ul style="list-style-type: none"> <li>• SDM-03 is not turned on.</li> <li>• The instrument is not correctly inserted into the instrument cradle.</li> <li>• The SDM-03 cover is not closed and secured.</li> <li>• The IR window is dirty.</li> </ul>	<ol style="list-style-type: none"> <li>1. Turn on the SDM-03. If it does not turn on, check that the AC adapter is plugged into an AC socket and to the jack on the back of the SDM-03.</li> <li>2. Check to make sure the instrument is inserted properly.</li> <li>3. Check to make sure the SDM-03 cover is closed and secured.</li> <li>4. Clean the IR window on the SDM-03 and the 03 Series.</li> <li>5. If the difficulties continue, contact RKI Instruments, Inc. for further instruction.</li> </ol>
<ul style="list-style-type: none"> <li>• Control buttons do not function correctly for standalone operation</li> </ul>	<ul style="list-style-type: none"> <li>• The SDM-03 is connected to a computer and the PC Controller program is running.</li> </ul>	<p>Disconnect the USB cable from the back of the SDM-03 if it is connected. See the SDM-03 PC Controlled Configuration Operator's Manual for instructions to use the SDM-03 in PC Controlled configuration.</p>
<ul style="list-style-type: none"> <li>• The COPY function does not copy files to the USB drive</li> </ul>	<ul style="list-style-type: none"> <li>• The USB drive is defective.</li> <li>• The USB drive is not inserted properly.</li> <li>• The SDM-03 is connected to a computer, the PC Controller program is running, and an instrument is turned on.</li> </ul>	<ol style="list-style-type: none"> <li>1. Perform a COPY operation with a different USB drive.</li> <li>2. Be sure that the USB drive is inserted correctly.</li> <li>3. Disconnect the SDM-03 from the computer.</li> <li>4. If the difficulties continue, contact RKI Instruments, Inc. for further instruction.</li> </ol>

---

## Calibration and Bump Test Records

The SDM-03 saves a record of each bump test and calibration performed. It is capable of saving up to 200 such records. When an SDM-03's memory becomes full, the oldest record is overwritten when a new record is saved. The records saved in the SDM-03's memory can be saved to a USB flash drive using the USB port on the front.

### Available Memory in the SDM-03

The COPY LED indicates how much of the SDM-03's memory has been used. The table below describes the various indications.

**Table 6: COPY LED Indications**

COPY LED Indication	Memory Used
Off	None. No records are saved
Solid Green	Less than 80% of the SDM-03's memory has been used.
Solid Amber	More than 80% of the SDM-03's memory has been used.
Solid Red	The docking station's memory is full. A newly saved record will overwrite the oldest one.

### Copying Calibration and Bump Test Records to a USB Flash Drive

The SDM-03 will only perform a copy operation if there is at least one record saved in its memory. If there are no records saved in the docking station's memory, the COPY LED will be off and the COPY button will not function. Do the following to copy calibration and bump test records in the SDM-03's memory to a USB flash drive.

---

**NOTE:** The USB port on the front of the docking station cannot be used to connect the SDM-03 to a computer, only to save calibration and bump test records to a USB flash drive.

---

1. Confirm that the AC Adapter is connected to the SDM-03 and to an AC wall socket.
2. Press and hold the SDM-03's POWER button. The LEDs will turn amber.
3. When the BUMP ▼ and CAL ▲ LEDs turn off, release the POWER button.
4. The COPY LED will be off or on steadily and the POWER LED will be blinking green. The amount of free memory in the SDM-03 will dictate the condition of the COPY LED (see "Available Memory in the SDM-03" above).

5. Install a USB flash drive into the USB port on the front of the SDM-03. The SDM-03 will take a few seconds to determine how much memory is available in the flash drive.
  - If the flash drive's available memory is not enough for the contents of the SDM-03's memory, the COPY LED will alternate between green and red. Enough memory will have to be cleared in the flash drive to make room for the records in the SDM-03's memory.
  - If there is enough available memory in the flash drive for the contents of the SDM-03's memory, the COPY LED will begin flashing in the same color that it was before installing the flash drive.
6. Press and hold the COPY button until the COPY LED turns red, then release it. The COPY LED will become solid red while the records in the docking station's memory are copied to the flash drive. In addition, if the flash drive has an LED, it will begin to blink.
7. When the COPY LED returns to its original color and begins blinking again and the flash drive's LED (if it has one) stops blinking, the copy operation is complete. Remove the flash drive from the USB port.

---

**NOTE:** If you pull out the flash drive while its LED is still blinking or the COPY LED is still solid red, the file saved in the flash drive with the calibration and bump test records may be incomplete.

---

8. If the flash drive has not already been used with a docking station, a folder named **DAT** will be created on the flash drive and a file with all the saved calibration and bump test records will be saved to this folder.

If the flash drive has been used before with a docking station, the file will be saved to the existing **DAT** folder.
9. The files on the flash drive can now be either transferred to a computer or kept on the flash drive for use with the Single Module Data Viewer Software. See "Bump Test and Calibration Record Files" below for a discussion of these files and how to use them.

## Clearing the SDM-03's Memory

Make sure that you save the bump test and calibration records in the SDM-03's memory to a flash drive before clearing its memory. The docking station's memory can be cleared by simultaneously pressing and holding the CAL ▲ and COPY buttons for five seconds. After the SDM-03's memory has been cleared, the COPY LED will turn off indicating there are no records to be copied.

## Bump Test and Calibration Record Files

Each time a copy function is performed, a file is saved to the flash drive in the **DAT** folder. The file name will begin with "SDM-03" and the remainder of the file name will depend on the serial number of the SDM-03 used and the date of the most recent bump test or calibration performed on the SDM-03. So it is possible to have multiple

files in the DAT folder from the SDM-03.

The files that an SDM-03 saves to a USB flash drive are structured so that they can be imported into a database controlled by the Single Module Data Viewer Software. See “Importing Files Into the Database” on page 46 for instructions to add files to the database.

### **Bump Testing or Calibrating and Saving Files To a Flash Drive Multiple Times In One Day**

The SDM-03 assigns file names to calibration and bump test record files based on the day of the most recent calibration or bump test record saved in the docking station’s memory. If bump tests or calibrations are performed, a copy operation is performed, then additional bump tests or calibrations are performed, and another copy operation is performed with the same flash drive all on the same day, the existing file on the flash drive from the first copy operation will be overwritten by the file from the second copy operation because its name will be the same as the new file. In this case, no information is lost since the second file saved to the flash drive includes all the records that were in the first file.

However, if bump tests or calibrations are performed, a copy operation is performed, and **the SDM-03’s memory is cleared**, then additional bump tests or calibrations are performed, and another copy operation is performed with the same flash drive all on the same day, this will result in the information in the file from the first copy operation being lost. This is because the file saved to the flash drive in the second copy operation only includes records since the memory was cleared and when it overwrites the file from the first copy operation, all the information in the first file is lost.

---

**CAUTION:** *If performing bump tests or calibrations and copying an SDM-03’s memory to a flash drive multiple times during the same day and the SDM-03’s memory is cleared, transfer the calibration/bump test record files from the flash drive to a computer hard drive or some other memory device before performing another copy operation to avoid loss of data.*

---

# Chapter 5: Single Module Data Viewer Program

---

## Overview

The Single Module Data Viewer Program is used to view, organize, and print bump test and calibration records that were created by the SDM-03 while used in the standalone configuration. It can also be used to export these records from its database for use in other programs. This chapter describes how to use the Single Module Data Viewer Program.

---

## Launching the Single Module Data Viewer Program

1. Click **Start** on the Windows<sup>®</sup> Icon Tray, then select **Programs/Single Module Data Viewer** or select the **Single Module Data Viewer** shortcut on the desktop.

---

**NOTE:** If you are starting the software for the first time, a message window appears informing you that a database has been created. If this occurs, click **OK**.

---

2. The Single Module Data Viewer program is launched and the data viewing window appears.

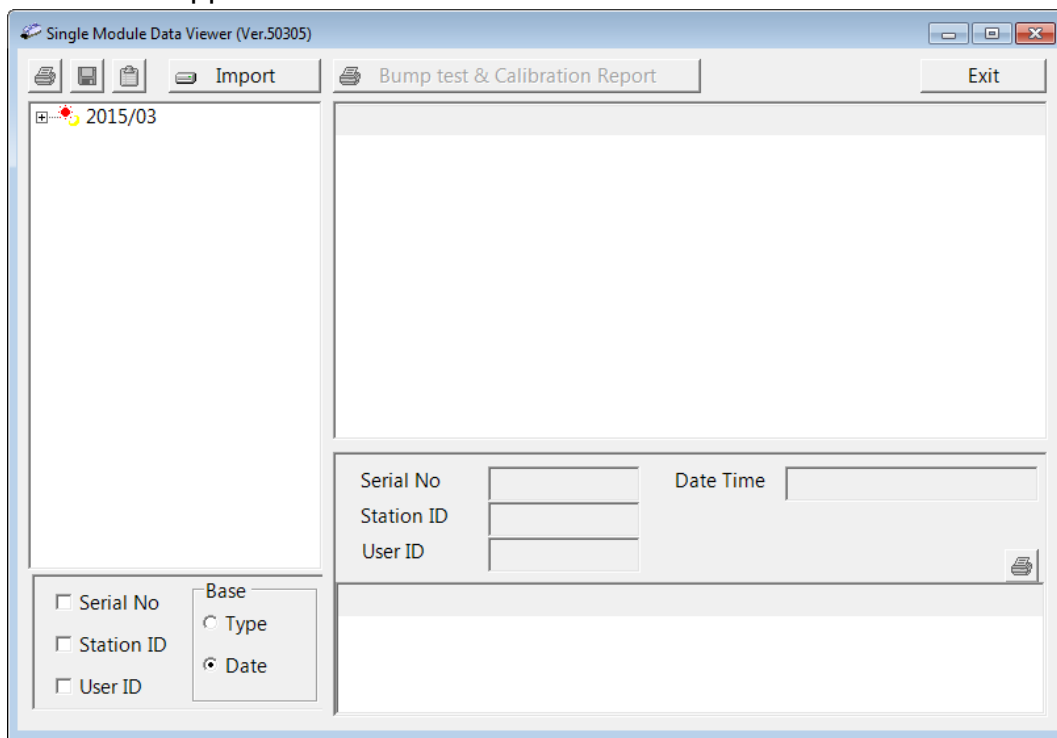

**Figure 18: Single Module Data Viewer Window**



---

**NOTE:** When you start the Single Module Data Viewer Program for the first time, there will be no data in the left part of the data viewing window since no data has been imported into the database yet.

---

## Using the Single Module Data Viewer Program

### Data Viewing Window

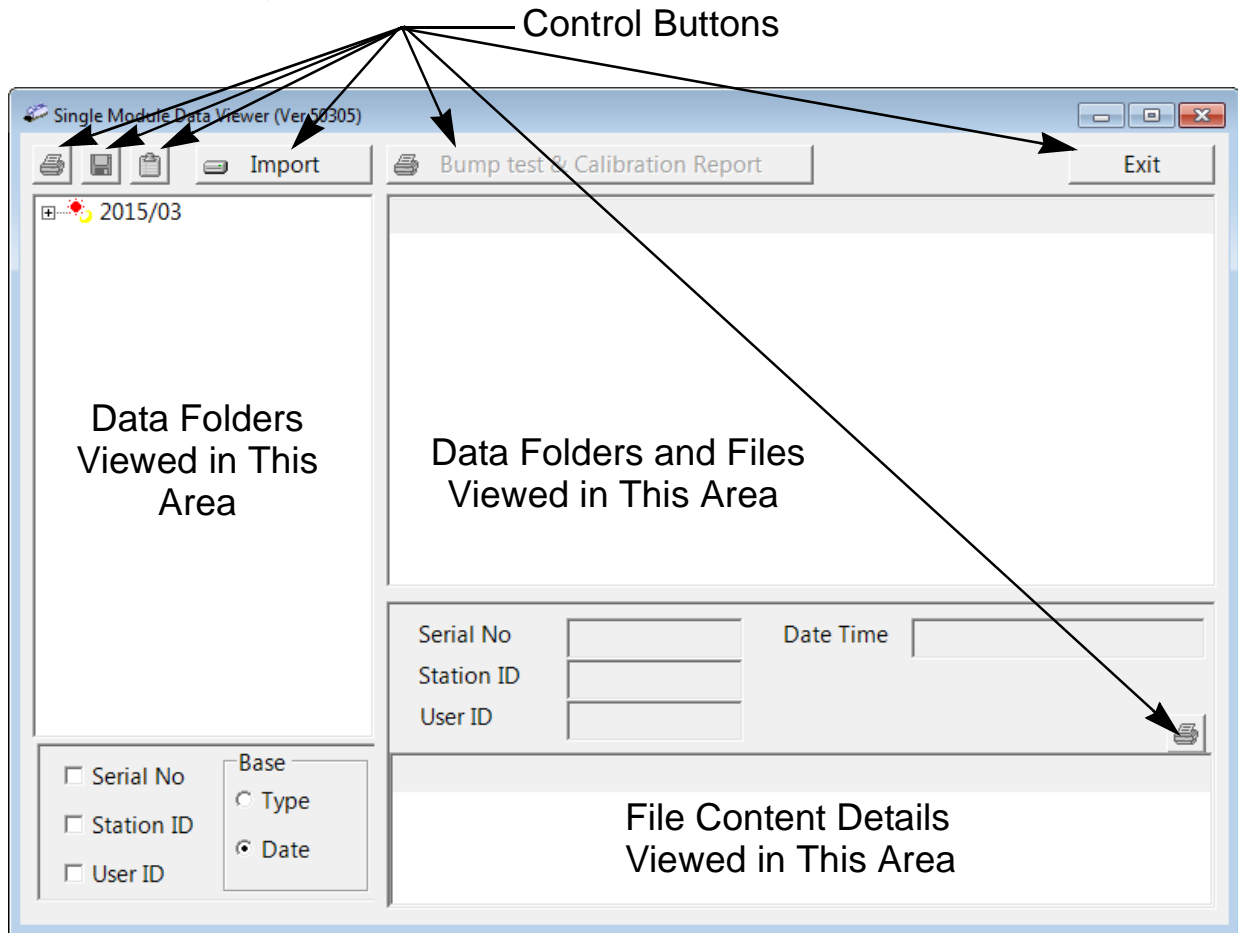

**Figure 19: Data Viewing Window**

All of the operations that can be performed in the Single Module Data Viewer Program can be executed from the data viewing window. There are function buttons along the top of the window and one in the lower right that initiate the various operations. The upper left side of the window displays the contents of the database. The lower left corner of the window has selection boxes that allow you to organize the data. The upper right side of the window shows the contents of the item selected in the upper left side, and the lower right side indicates the contents of the item selected in the area above it. In the example above, the data is organized by date.

You can do the following in the data viewing window:

- Import files into the database that were created by an SDM-03

- View the bump test and calibration data saved in the database.
- Delete data.
- Print bump test or calibration results (pass or fail indication only).
- Copy bump test or calibration records to the clipboard or to a particular location on your computer or network.
- Print a bump test or calibration report that includes the results and all gas readings.

## Importing Files Into the Database

The files generated by the SDM-03 are structured to be imported into the Single Module Data Viewer Program database. To import data files into the database, do the following:

1. While in the Data Viewing Window, click the **Import** button. The Import Window will appear.

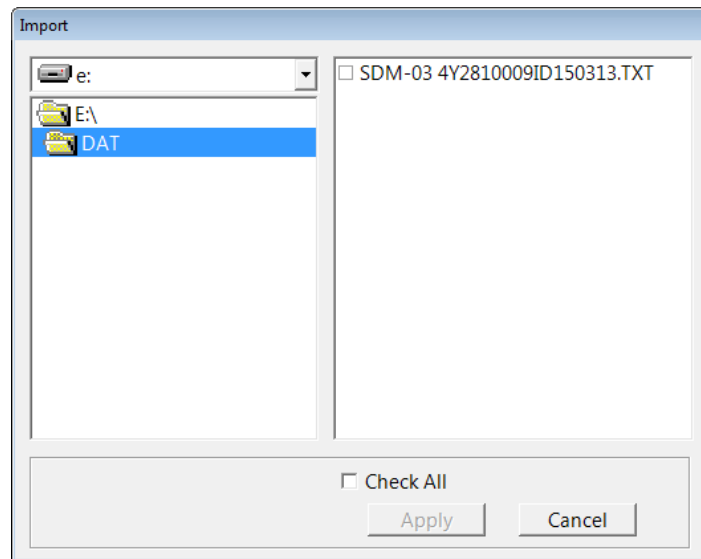

**Figure 20: Import Window**

2. Navigate to the location of the files that you want to import into the database.
3. Select the files that you want to import or use the Check All box to select all of the files.
4. Click the **Apply** button. A window will appear for a few seconds indicating that the file or files are being imported.
5. The files are now added to the database.

## Organizing the Data

When viewing the data, it can be organized in two ways:

1. Base View Format

In base view format, neither of the Serial No, Station ID, or User ID selection boxes in the lower left of the window are selected and the Base box appears next to these selection boxes with two radio buttons. The data can be organized by either the data Type (bump test and calibration data) or by Date (year and month). The example below shows the data organized by Type.

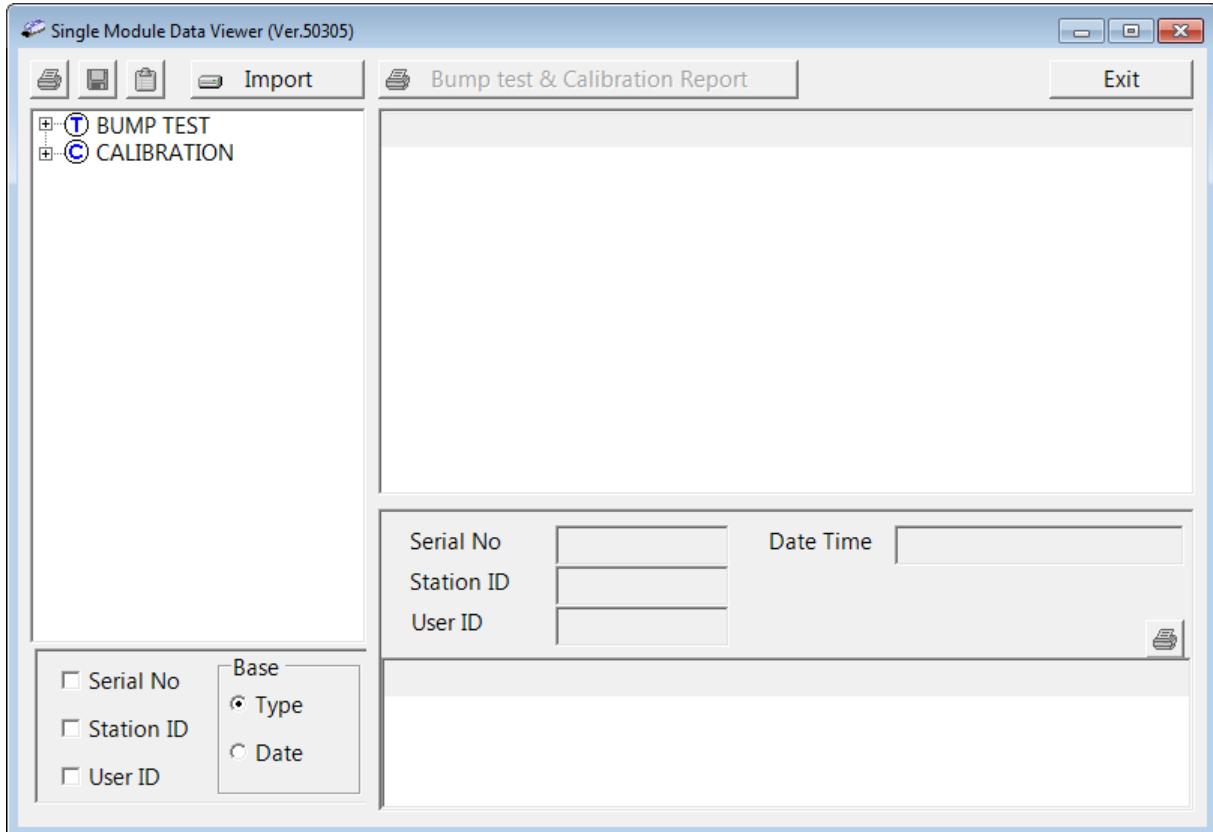

**Figure 21: Data in Base Viewing Format, Type**

## 2. ID View Format

In ID view format, the data can be organized by one or more of the following items depending on which selection box or boxes in the lower left corner of the data viewing window are selected:

- Serial Number
- Station ID
- User ID

If any of these boxes is selected, the Base box disappears. The example below shows the data organized by serial number.

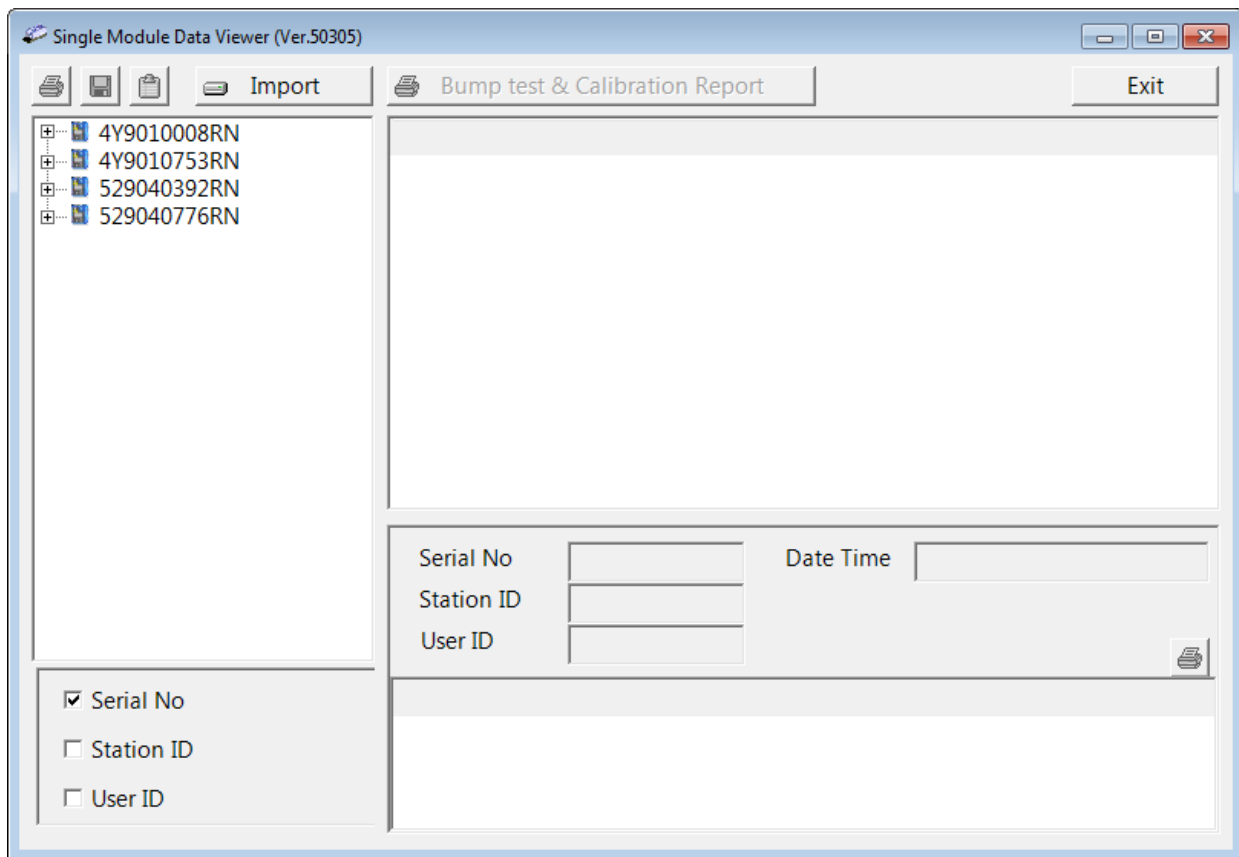

**Figure 22: Data in ID Viewing Format**

## Viewing the Data

Once you have selected how you want to organize the data:

1. Click the expanded view symbol (+) next to an item, folder or icon, in the left side of the data viewing window or double click the item to view the contents below it. Single click on an item to view the contents in the right side of the window. If an item is expanded and you want to close it, click the (-) symbol next to the item or double click it.

- When an item no longer has a (+) or (-) symbol next to it, single click it and the contents of the item will be shown on the right side of the window.
- If you are viewing data in base view format with the data organized by type, expand the item, bump test or calibration, you wish to view. Icons organized by year/month will appear below the bump test or calibration icon. Click on the item whose contents you wish to see. The bump test or calibration files will be shown in the upper right side of the data view window.

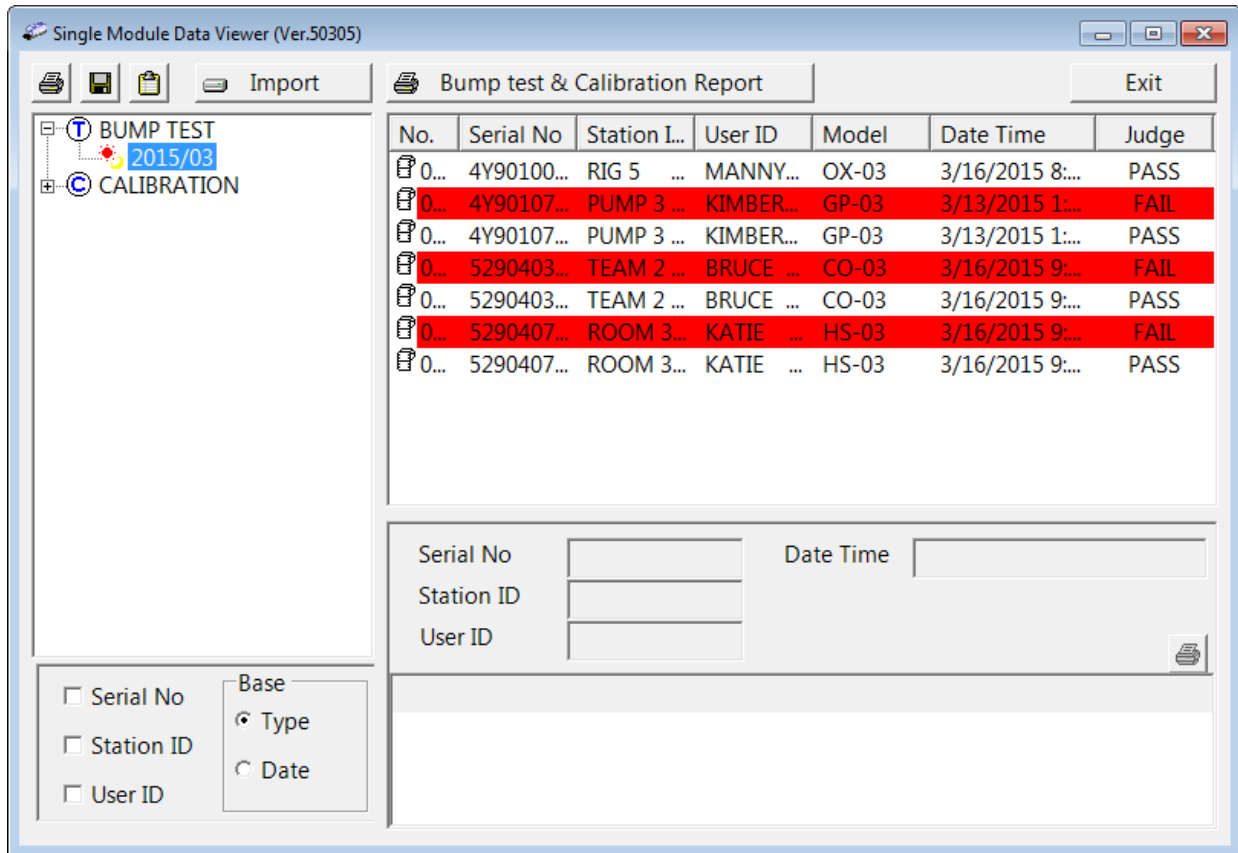

**Figure 23: Calibration/Bump Test Files in Base View Format by Type**

If you organize the data by date, then folders organized by year/month appear in the left side of the window. Expand the folder you want to see and click on the calibration or bump test folder. The calibration or bump test files will appear in the upper right side of the window.

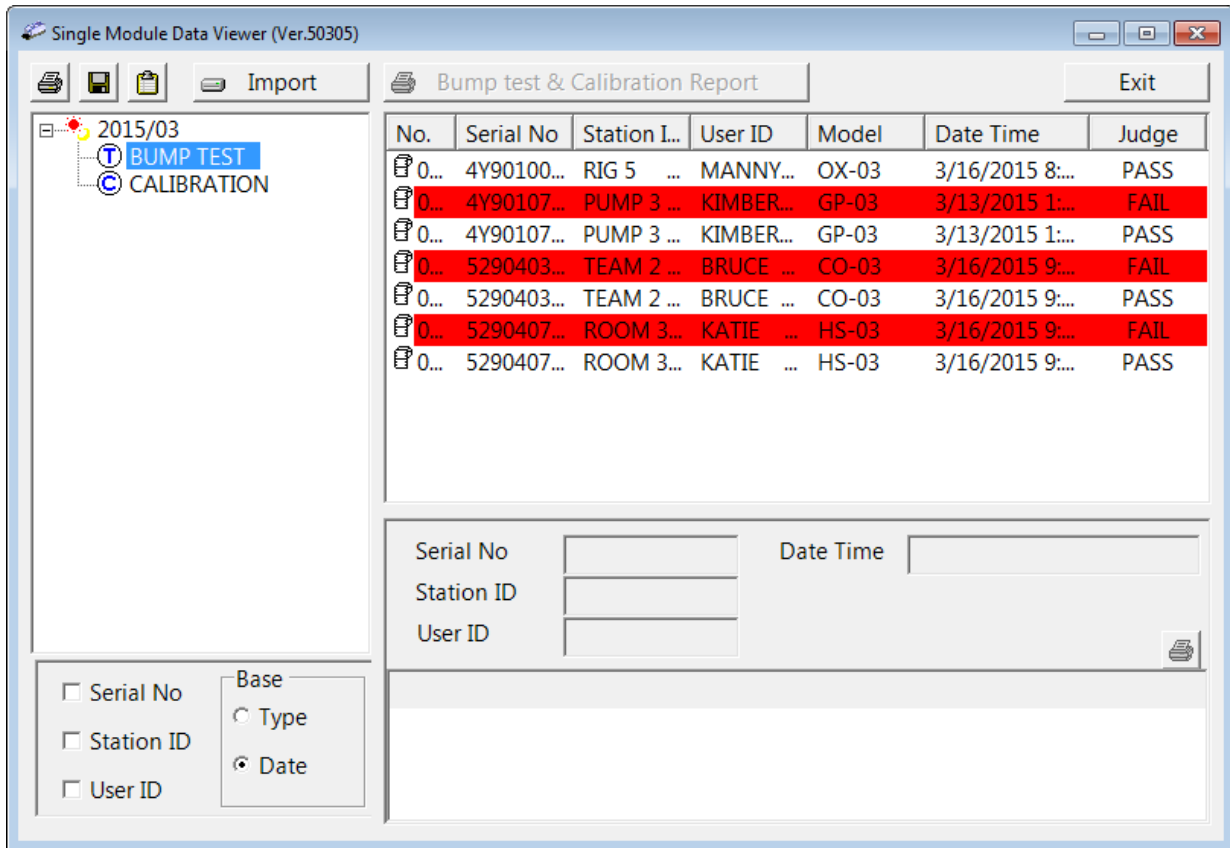
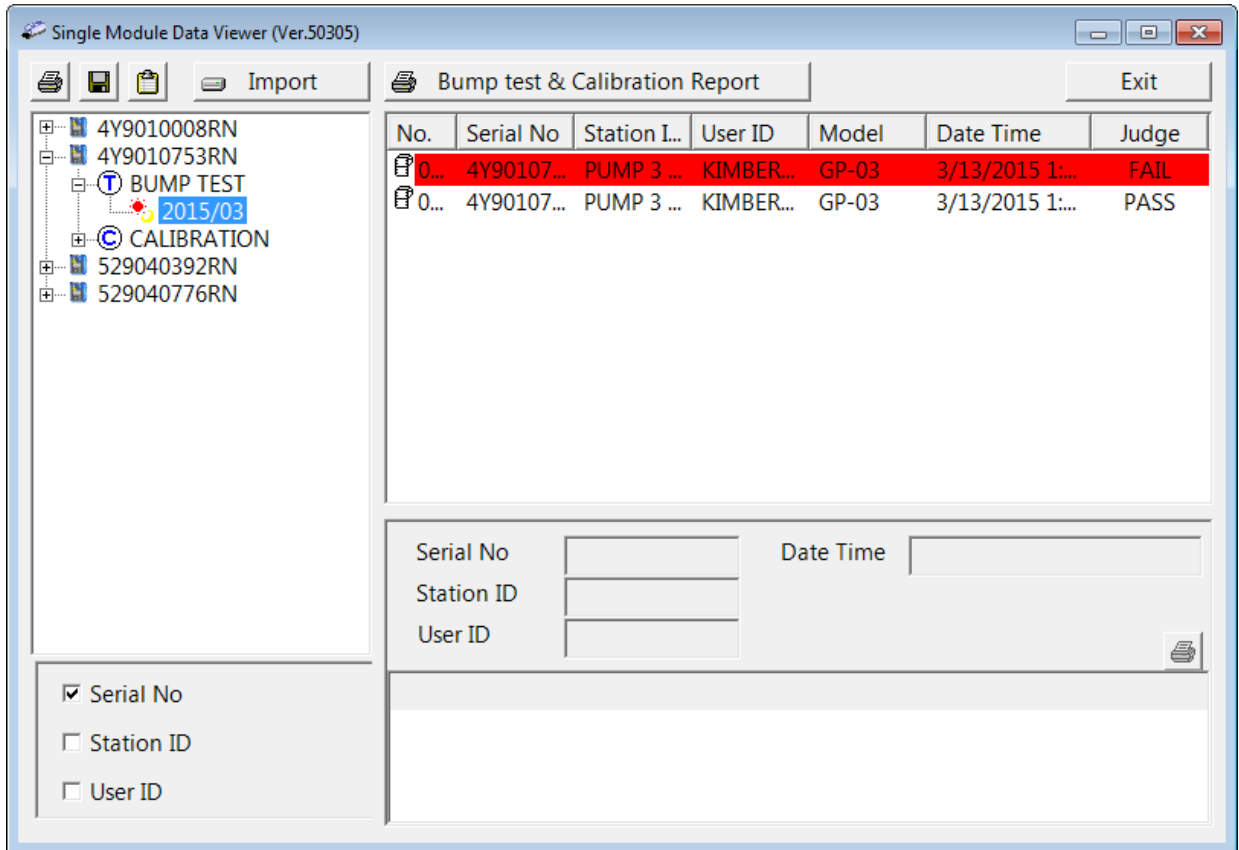

Figure 24: Calibration/Bump Test Files in Base View Format by Date

If you are viewing data in ID view format, expand the folders in the left side of the window until the bump test or calibration folder you wish to view is visible. Expand the folder by clicking the (+) symbol next to it. Folders organized by year/month will be listed below the calibration or bump test folder. Click the folder whose contents you want to view and the calibration or bump test files in it will be shown in the upper right side of the data view window. The example below is organized by serial number.



**Figure 25: Calibration/Bump Test Files in ID View Format**

- Files that record a failed calibration or bump test are highlighted in red. Files that record a passed calibration or bump test are not highlighted.

- To view the file contents, click on the file in the upper right part of the data view window that you wish to view. The contents in the file will appear in the lower right part of the window. The contents include the instrument's serial number, station ID, user ID, bump test or calibration time, test gas, and gas readings during the operation. "Pre Cal" gas readings for a failed calibration that display "--" instead of a number indicate a failed zero adjustment.

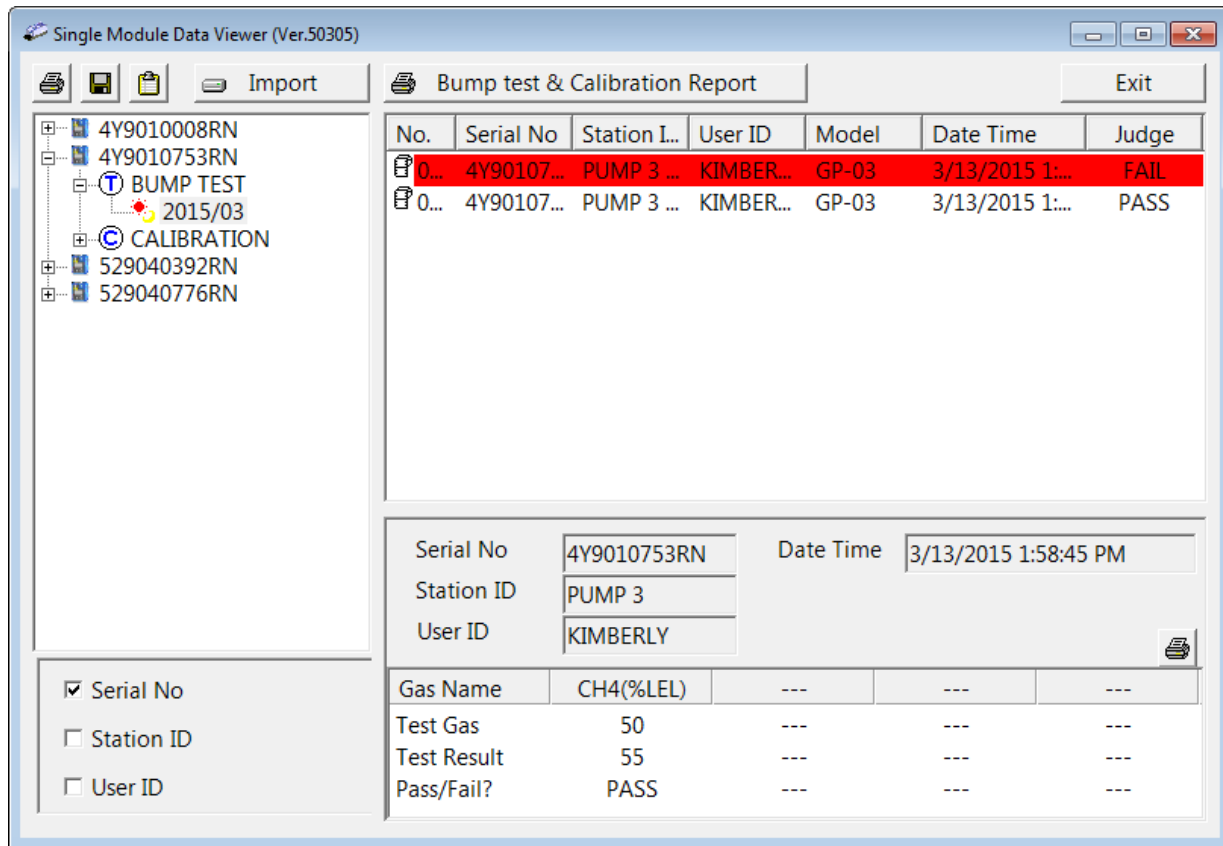

**Figure 26: Bump Test File Selected**

- To print the files as they appear in the upper right part of the data view window, click the print button in the upper left corner of the window. A dialog box will appear confirming if you want to print. Click **OK**.
- To print only the pass or fail result of all files in the upper right window, click the **Bump test & Calibration Report** button above the files. A dialog box will appear showing the selected printer and confirming if you want to print. Verify that the selected printer is correct and click **OK**.
- To print the complete results, pass/fail and gas reading, of one of the files in the upper right part of the data view window, click on one of the files to select it and then click the print button that appears above the file details in the lower right. A dialog box will appear showing the selected printer and confirming if you want to print. Verify that the selected printer is correct and click **OK**.
- To save files as they appear in the upper right part of the data view window, click the **Save To File** button to the right of the print button in the upper left



corner of the window. The **Save To File** button has a floppy disk icon in it. A “Save As” dialog box will appear for you to specify the filename, file location, and file type. Select the **Text files (\*.csv)** choice to save the information as a comma separated value file that may be opened with a spreadsheet program such as Microsoft Excel.

10. To save files to the clipboard as they appear in the upper right part of the data view window, click the **Copy To Clipboard** button. The **Copy To Clipboard** button has a clipboard icon in it. The file will be saved to the clipboard. It can then be pasted into a document by using the Paste command in an application.

## Deleting Data

You can delete an instrument, bump test data, or calibration data in the data view window. The delete function is password protected to avoid accidental deletion of instruments or data. To delete an instrument or data, perform the following:

1. Find the item you wish to delete and right click it. A window will appear that says “Delete(D) Change Password(C)”.

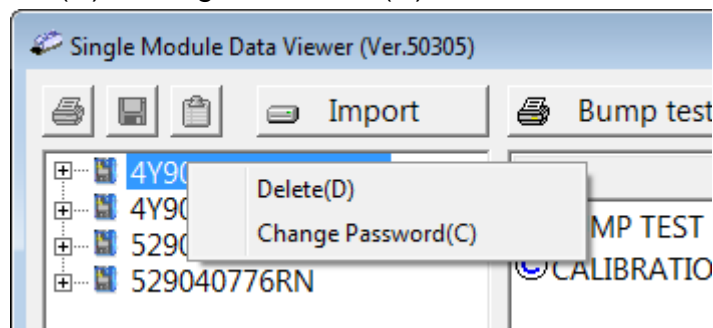

2. Click on “Delete(D)”. A password entry window will appear.

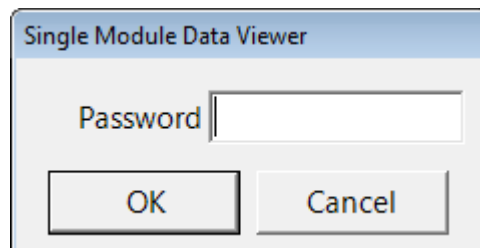

3. Enter the password and click **OK**. The factory set password is “ABCDE” and is case sensitive. A confirmation window will appear.

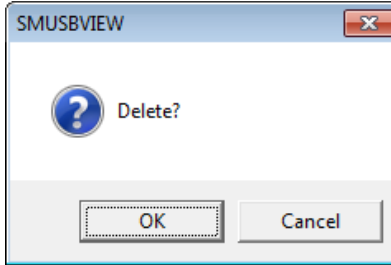

4. Click **OK** to complete the deletion of the selected item.

## Changing the Password

The factory password is “ABCDE” and is case sensitive. You can change the password in the data view window. To change the password perform the following:

1. Right click in the upper right or upper left part of the data view window. A window will appear that says “Delete(D) Change Password(C)”.

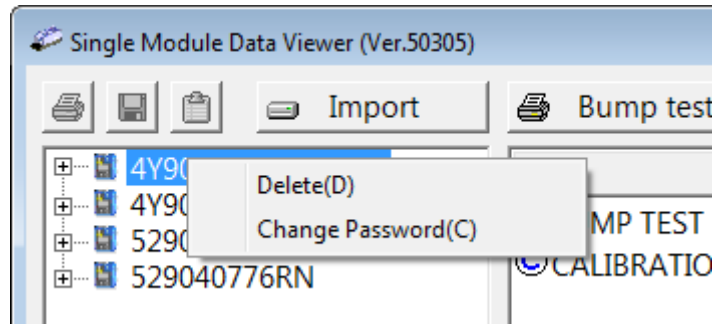

2. Click on “Change Password(C)”. A window will appear prompting you for the current password.

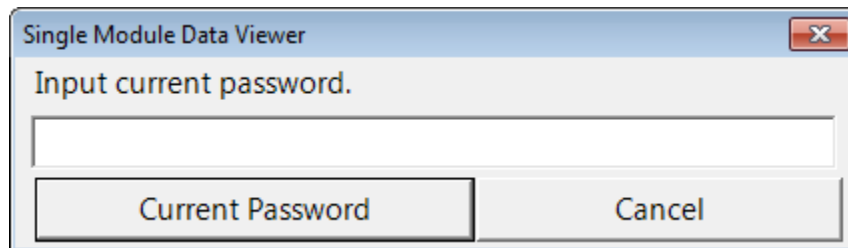

3. Enter the current password and click the **Current Password** button. A window will appear prompting you for the new password.

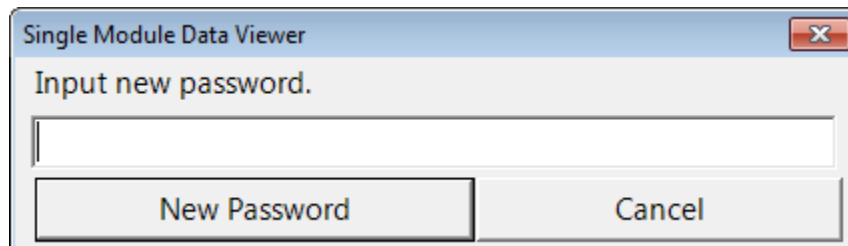

4. Enter the new password and click the **New Password** button. A confirmation window will appear prompting you for the new password again.

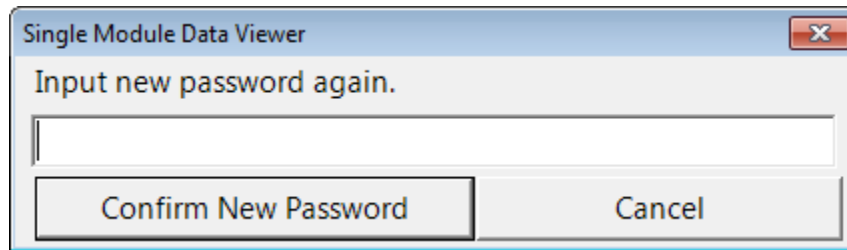

5. Enter the new password again and click the **Confirm New Password** button. A window will appear indicating that the password has been changed.

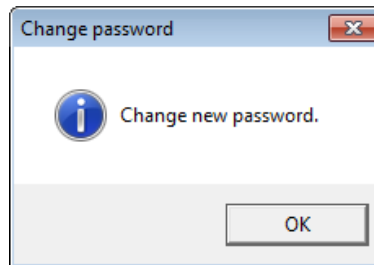

6. Click **OK** to complete the password update.

## Exiting the Program

To exit the Single Module Data Viewer Program, do the following:

1. Click the **Exit** button in the upper right corner of the data view window. A confirmation window will appear.
2. Click the **OK** button to exit the program or the **Cancel** button to return to the program.

---

## Spare Parts List

**Table 7: Spare Parts List**

Part Number	Description
06-1248RK	Polyurethane tubing, 5/16-inch OD x 3/16-inch ID, for connecting to inlet fittings
06-1248RK-03	3 foot length of 5/16-inch OD x 3/16-inch ID, for connecting calibration cylinder to inlet fittings
06-1254RK	Polyurethane tubing, 7/16-inch OD x 5/16-inch ID, for exhaust tube, 10 feet maximum
33-0167RK	Particle air filter replacement, CF-8369
49-0115RK	Single-port AC adapter

**Table 7: Spare Parts List**

<b>Part Number</b>	<b>Description</b>
49-2058RK-04	4-port AC adapter
71-0359	Operator's Manual, SDM-03 Docking Station Standalone Configuration (this document)
71-0360	Operator's Manual, SDM-03 Docking Station PC Controller Configuration
71-8007RK	Product CD for SDM-GX Series, includes Single Module Data Viewer Program
81-0012RK-01	Calibration cylinder, 50 %LEL CH <sub>4</sub> in air, 34 liter steel
81-0012RK-03	Calibration cylinder, 50 %LEL CH <sub>4</sub> in air, 103 liter steel
81-0018RK-01	Calibration cylinder, 50 %LEL isobutane in air, 34 liter steel
81-0018RK-03	Calibration cylinder, 50 %LEL isobutane in air, 103 liter steel
81-0064RK-01	Calibration cylinder, 50 ppm CO in air, 34 liter steel
81-0064RK-03	Calibration cylinder, 50 ppm CO in air, 103 liter steel
81-0076RK	Zero air cylinder, 17 liter steel
81-0076RK-01	Zero air cylinder, 34 liter steel
81-0076RK-03	Zero air cylinder, 103 liter steel
81-0078RK-01	Calibration cylinder, 100% nitrogen, 34 liter steel
81-0078RK-03	Calibration cylinder, 100% nitrogen, 103 liter steel
81-0151RK-02	Calibration cylinder, 25 ppm H <sub>2</sub> S in nitrogen, 58 liter aluminum
81-0151RK-04	Calibration cylinder, 25 ppm H <sub>2</sub> S in nitrogen, 34 liter aluminum
81-1054RK	Demand flow regulator, 58/103 liter cylinders
81-1055RK	Demand flow regulator, for 17/34 liter steel cylinders
81-SDM03	Docking station for 03 Series, with AC adapter