



## RFID LOGGER – USER MANUAL

Rev 1.0

The RFID logger is a small compact data logging device that uses near field communication (NFC) to communicate with Android devices that have NFC capability or with the PC using a special RFID reader that plugs into a USB port.

This logger can record 8100 samples in non-volatile memory at a user selectable rate from 10 seconds to 60 minutes per sample, equivalent to a record time of 22 hours to over 338 days. This time is halved for a two channel device. The logger can also acquire samples at a rate faster than the record interval, and these samples can be averaged, or the maximums and minimums calculated.



The logger has a bi-colored LED that is used to indicate record status and alarms when the button is pressed momentarily. The LED blinks twice – the first blink is the Record status and the second blink is the alarm status. The button can also be used to stop and start the recording if programmed by the user.

There are three user programmable record modes – record now, record on button press, record later.

**Record Now** – the logger starts recording as soon as a configuration file is uploaded to it using the Android device or the PC USB reader.

**Record on button press** – the logger remains dormant until the user performs a long press on the button at which time recording starts. Once started, the recording can be ended by a second long press on the button.

**Record later** – the logger remains dormant for a period of up to 999 hours as programmed by the user after the configuration file is uploaded to the device before starting to record.

The record status is indicated by the first LED blink. **RED** means the unit is not recording, **GREEN** means the unit is currently recording.

The logger has four alarms which can be programmed as high or low by the user. The alarm status can be checked by a user with a short press of the button. The alarm status is indicated by the second LED blink. **RED** means an alarm occurred, **GREEN** means no alarm occurred. The alarms become active when the logger starts recording.

Each logger has a unique fixed serial number and a 20 character unit tag which can be programmed by the user.

Software allows the user to configure the logger. The current configuration can be read from the logger using the Android device or the PC USB reader, or can be loaded from a stored file on the PC or Android device. The user can alter the record mode, record rate, sample rates and data type – instantaneous,



# MONARCH INSTRUMENT

*the professional's choice*

average, minimum, or maximum. The unit tag can be modified, the time zone selected, and the alarms programmed. This configuration is then uploaded to the logger to start the record cycle.

Software is also used to upload and analyze the recorded data. The data can be depicted graphically or in the form of a data table. There are different summaries available which indicate record start and end times, number of samples, average maximum and minimum of the data recorded and alarm status.

The user can perform a quick read which will indicate record status, record start and end times and alarm status. This takes just a second and can be used by the user to determine if data needs to be read from the device, a process that takes around five to ten seconds.

On the PC, data can be saved to a file in native format or as a CSV file for import into an Excel spreadsheet. On the Android device data can be saved to a file or emailed to a remote recipient.

## Reading and Writing

The logger uses near field communication (NFC) to communicate with Android devices that have NFC capability or the PC using a special reader that plugs into a USB port. Near field communication is a form of low-power radio communication that is effective only when the devices are in close proximity to one another (touching). The logger has a small antenna that needs to be within the field of the companion device, either the Android device (smart phone or tablet) or the PC USB reader. Communication is position dependent.

The antenna coil in the logger is between the button and the loop handle at the top of the device. You need to know where the antenna coil is on your phone/tablet, and ensure that the logger antenna coil is within that coil.

Keep the logger close to your Android device with the logger antenna coil in the NFC Area of the Android device. If possible keep the battery away from the NFC field.

Follow the instructions in the Android application.

## LED Status Indication

The LED on the device will indicate the record and alarm status by blinking when the button is pressed and released quickly. (Less than a second).

The first LED blink indicates the record status: **RED** means the unit is not recording, **GREEN** means the unit is currently recording.

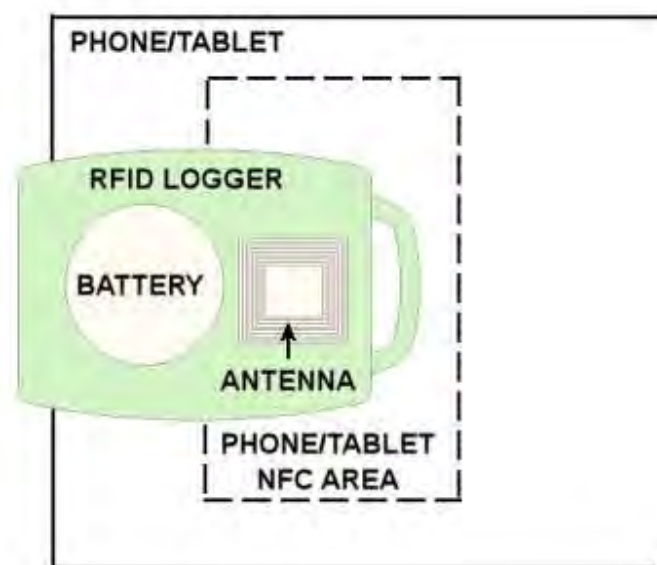



# MONARCH INSTRUMENT

*the professional's choice*

The second LED blink indicates the alarm status: **RED** means an alarm occurred, **GREEN** means no alarm occurred. Note that there will be no second blink if the unit has not started recording.







Note: If the logger has not been programmed – no configuration loaded, the LED will blink **AMBER** twice. If the logger successfully receives a new configuration file it will blink **GREEN** once if it has a delayed record start or twice if it starts recording right away.

## Operational Overview

### LED:

Response to quick button press.

1 <sup>st</sup> Blink – Record Status:	RED – not recording	GREEN – recording
2 <sup>nd</sup> Blink – Alarm Status:	RED – No Alarm occurred	GREEN – Alarm occurred

	Single <b>RED</b> blink indicates logger is waiting to record, either on button press or delay start		Recording, No Alarm occurred
	Recording ended, No Alarm occurred		Recording, Alarm occurred
	Recording ended, Alarm occurred		Recording, No Alarm occurred

### Button:

Short Press < 3 sec: LED Status Indication – see LED above

Long Press > 3 sec: Only valid in **Button Press Mode**

If this is 1<sup>st</sup> long press since loading config – START Recording, LED blinks **GREEN** twice

If this is 1<sup>st</sup> long press WHILE recording - STOP Recording, LED blinks **RED**, Alarm Status

Any button press after recording has STOPPED will show status on LED - **RED**, Alarm Status

### Modes:

#### Record Now:

Button Press – shows status per LED above.

Once started by user cannot be stopped until memory fills.

#### Button Press:

Button Press – if < 3 sec shows status

If > 3 sec, starts or stops recording per Button Long Press above. (1 time cycle)

Once STOPPED by button press cannot start recording unless new config loaded.

#### Delayed Start:

Button Press - shows status per LED above. Once started by user cannot be stopped until memory fills.

Note that if recording has **not started** due to delay not reached, the record status will show as NOT RECORDING.  (Single **RED** blink)

Once a record cycle has ended, by time or button press, subsequent button presses will show status. To Restart or reset any record mode the device must have a new configuration file downloaded.