

DATA SHEET

# Si-CA 130

**Residential & commercial combustion analyzer**  
**The latest in combustion analysis technology**

**Compact, Light and Durable Design**



Note: Phone not included.



Up to three gas sensors O<sub>2</sub>, CO, and NO or Low NO<sub>x</sub> (for NO<sub>x</sub>)



Large color touch screen



Lightweight, only 350 g (12 oz)



Field replaceable pre-calibrated sensors



CO sensor measurement up to 8000 ppm



Data management with automatic logging & report creation through app/PC software



- Predictive maintenance with estimated sensor life & calibration reminders
- Draft & differential pressure measurements
- Calculated CO<sub>2</sub> % value
- Auto pump cut-off for high CO levels (user-adjustable)
- NO<sub>x</sub> capable with NO sensor (optional)
- One Touch Pump On/Off with Purge
- PC software with wireless and USB connectivity
- Combustion efficiency & excess air calculations

- Graphical data display
- Customizable gas analysis screen
- Sample conditioning unit for low NO<sub>x</sub> & high moisture applications
- CO & CO<sub>2</sub> Monitoring in Ambient Air
- Smart Air Temperature Probe
- Protective rubber holster
- Maintenance contracts and extended warranties available

**Dimensions**

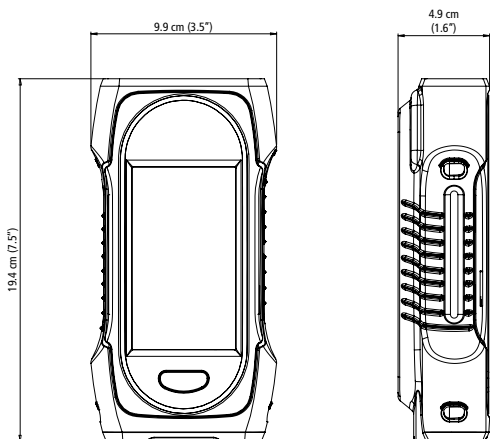

**Compact design**



## Parameter specifications

Parameter	Sensor	Measuring range	Resolution	Accuracy <sup>(1)</sup>	T <sub>90</sub> response time
O <sub>2</sub>	Electrochemical	0 to 25%	0.01%	±0.2% vol	< 30 s
CO	Electrochemical	0 to 8000 ppm	1 ppm	±8 ppm < 160 ppm ±5% rdg up to 2000 ppm ±10% rdg > 2000 ppm	< 40 s
CO(H <sub>2</sub> )	Electrochemical	0 to 8000 ppm	1 ppm	±8 ppm < 160 ppm ±5% rdg up to 2000 ppm ±10% rdg > 2000 ppm	< 40 s
CO <sub>2</sub>	Calculated	0 to 99.9%	0.1%	-	-
NO (optional)	Electrochemical	0 to 5,000 ppm	1 ppm	±5 ppm < 100 ppm ±5% rdg > 100 ppm	< 40 s
Low NO	Electrochemical	0 to 300 ppm	0.1 ppm	±1.5 ppm < 30 ppm ±5 % rdg > 30 ppm	< 40 s
NOx (optional)	Calculated	0 to 7500 ppm	1 ppm	-	-
Low NOx	Calculated	0 to 450 ppm	0.1 ppm	-	-
Flue temperature	TcK	-20 to +1250 °C -4 to +2282 °F	0.1 °C 0.1 °F	±2 °C or ±0.5% rdg <sup>(2)</sup> ±3.6 °F or ±0.5% rdg <sup>(2)</sup>	-
	NTC or TcK	-20 to +120 °C -4 to +248 °F	0.1 °C 0.1 °F	±2 °C ±3.6 °F	-
Air temperature	Pt100	-40 to 250 °C -40 to 482 °F	0.1 °C 0.1 °F	±(0.3% rdg ±0.25) °C -40°F to 32 °F: ±(-0.3% rdg +0.6) °F 32°F to 482 °F: ±(0.3% rdg +0.4) °F	-
	Calculated	0 to 1250 °C 0 to 2282 °F	0.1 °C 0.1 °F	-	-
Differential temperature	Calculated	0 to 1250 °C 0 to 2282 °F	0.1 °C 0.1 °F	-	-
Pressure/Draft	Semiconductor	-200 to +200 mbar -80 to +80 inH <sub>2</sub> O	0.01 mbar	±1% rdg ±0.03 mbar	-
			0.001 inH <sub>2</sub> O	±1% rdg ±0.012 inH <sub>2</sub> O	
High accuracy draft	Semiconductor	500 Pa	0.1 Pa	±0.5 Pa < 10 Pa ±3 Pa up to 150 Pa ±2 % rdg > 150 Pa	-
Excess air	Calculated	0 to 999%	1%	-	-
Efficiency	Calculated	0 to 100% (Gross/HHV <sup>(3)</sup> )	0.1%	-	-
Efficiency (condensation)	Calculated	0 to 125% (Net/LHV <sup>(4)</sup> )	0.1%	-	-
Stack Gas velocity	Calculated	0 to 99 m/s	0.1 m/s	-	-
		0 to 19,500 fpm	1 fpm	-	

<sup>(1)</sup>All accuracies indicated in this document were stated in laboratory conditions at 20 °C (68 °F) and 1013 mbar and can be guaranteed for measurement carried out in the same conditions.

<sup>(2)</sup>Accuracy given for the analyzer only.

<sup>(3)</sup>For Higher Heating Value / <sup>(4)</sup>For Lower Heating Value

## General features

Dimensions	19.4 x 9.9 x 4.9 cm (7.5 x 3.5 x 4.9")
Weight	350 g (12 oz)
Display	Color Touch Screen with Graphing; Size: 480 x 272 pixels
Keypad	1 On-Off key
Material	ABS-PC
Protection	IP42
Connection	- Wireless: class 2 range, range frequency from 2402 MHz to 2480 MHz with a transmit power of 1 dBm. Range up to 15 m (50 ft), depending on smartphone radio strength. Minimum required versions: Android 8.0, iOS 12.4, BLE 4.0 Low Energy - USB
Power supply	Rechargeable battery, USB power supply Li-Ion 5100 mA/h 3.6 V battery / Power supply voltage of the mains unit: 100-240 Vac, 50-60 Hz Mains unit: 5 Vdc/2A
Battery	Battery life > 8 h; Charging time: Fully charge: < 6.5 h; 50%: < 2.5 h
Environmental conditions of use	Temperature: from -5 to 45 °C (23 to 113 °F), Hygrometry: in non-condensing conditions (< 85% RH) Maximum altitude: 2000 m (6561')
Storage temperature	From -20 to 50 °C (-4 to 122 °F)
Languages	English, French, German, Spanish, Italian, Portuguese, Chinese
European Union Directives	2014/53/EU (RED); 2015/863 EU (RoHS 3)
Regulations	EN 50379-1 and EN 50379-2; UNI 7129; UNI 11137; UNI 10389; UNI 10845; III & cIII Certification

## Apps and PC software

- Free apps for iOS & Android mobile devices
- PC software with USB & wireless connectivity
- Fast, easy wireless connection
- Remote live view of combustion analysis data as list or graph
- Remote control to change settings
- Data saving, including automatic logging
- Report creation in PDF, CSV (for Excel) and XML formats
- Databases for customers, operators & equipment



Download app



Graph view

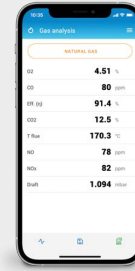

Data view

## Si-CA 130 kit content





- Si-CA 130 analyzer
- O<sub>2</sub> & CO gas sensors (NO or low NO optional)
- Protective rubber holster
- Flue gas probe with dual hose
- Water trap with filter
- AC power supply / charger
- USB cable
- Mobile app & PC software
- Internal wireless communication module
- Carrying case
- Quick Start Guide
- Calibration certificate



## Optional accessories\*

Part number	Description	Illustration
27520 (NO) 27521 (Low NO)	NO or Low NO sensor for NOx	
27532 (180 mm) 27533 (300 mm) 27534 (750 mm)	180, 300 and 750 mm probes available	
27936	180 mm flexible probe	
27544	Draft probe	
24646	Smart air temperature probe with 2 m cable	
27865	Pt100 temperature probe	
27547	CO ambient probe	
27548	CO <sub>2</sub> ambient probe	
27546	Remote wireless printer	

\*See the Si-CA analyser accessories datasheet for more details.

Part number	Description	Illustration
27537	3 m dual hose extension	
27538	Differential pressure hose kit	
11994	Manual smoke pump kit	
26811	SCU (Sample Conditioning Unit)	

### Example of analyzer screens

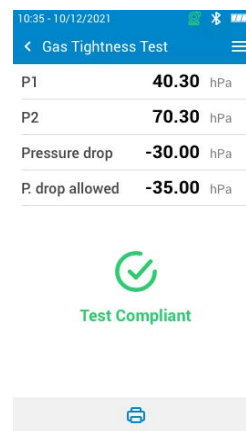
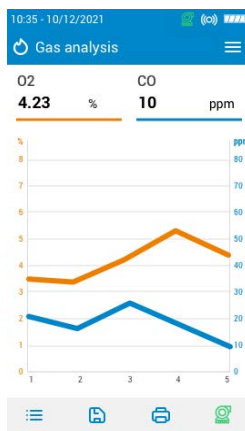

### Ordering Information

Item #	Reference	Description
Si-CA 130 Kit 2AS	27507	Si-CA 130 Gas Analyzer Kit 2AS, includes two gas sensors (O <sub>2</sub> , CO), 180 mm Probe rated to 800 °C (1472 °F) with 2 m dual hose, vinyl carrying case, rubber holster, water trap with filter, charger with plug set, USB-C cable, quick start guide, calibration certificate
Si-CA 130 Kit 2AH	27508	Si-CA 130 Gas Analyzer Kit 2AH, includes two gas sensors (O <sub>2</sub> , CO), 180 mm Probe rated to 800 °C (1472 °F) with 2 m dual hose, ABS hard plastic carrying case, rubber holster, water trap with filter, charger with plug set, USB-C cable, quick start guide, calibration certificate
Si-CA 130 Kit 2ASF	27937	Si-CA 130 Gas Analyzer Kit 2ASF, includes two gas sensors (O <sub>2</sub> , CO) upgradeable to a 3rd sensor (NO or NO low range), automatic pump cut-off protection for sensors, 180 mm Flexible sampling probe with 2 m hose and water trap with filter, magnetic support, protective rubber holster, vinyl carrying case, power charger, USB cable, quick start guide and calibration certificate.

Item #	Reference	Description
Si-CA 130 Kit 2AS CO-H2	27878	Si-CA 130 Gas Analyzer Kit 2AS CO-H2, includes two gas sensors (O <sub>2</sub> , CO-H <sub>2</sub> ), 180 mm Probe rated to 800 °C (1472 °F) with 2 m dual hose, vinyl carrying case, rubber holster, water trap with filter, charger with plug set, USB-C cable, quick start guide, calibration certificate
Si-CA 130 Kit 2ASD CO-H2	27921	Si-CA 130 Gas Analyzer Kit 2ASD CO-H2, includes two gas sensors (O <sub>2</sub> , CO-H <sub>2</sub> ), 180 mm Probe rated to 800 °C (1472 °F) with 2 m dual hose, high accuracy draft sensor included, vinyl carrying case, rubber holster, water trap with filter, charger with plug set, USB-C cable, quick start guide, calibration certificate
Si-CA 130 Kit 2BS	27509	Si-CA 130 Gas Analyzer Kit 2BS, includes two gas sensors (O <sub>2</sub> , CO), 300 mm Probe rated to 800 °C (1472 °F) with 3 m dual hose, vinyl carrying case, rubber holster, water trap with filter, charger with plug set, USB-C cable, quick start guide, calibration certificate
Si-CA 130 Kit 2BH	27510	Si-CA 130 Gas Analyzer Kit 2BH, includes two gas sensors (O <sub>2</sub> , CO), 300 mm Probe rated to 800 °C (1472 °F) with 3 m dual hose, ABS hard plastic carrying case, rubber holster, water trap with filter, charger with plug set, USB-C cable, quick start guide, calibration certificate
Si-CA 130 Kit 3AS	27511	Si-CA 130 Gas Analyzer Kit 3AS, includes three gas sensors (O <sub>2</sub> , CO, NO), 180 mm Probe rated to 800 °C (1472 °F) with 2 m dual hose, vinyl carrying case, rubber holster, water trap with filter, charger with plug set, USB-C cable, quick start guide, calibration certificate
Si-CA 130 Kit 3AH	27512	Si-CA 130 Gas Analyzer Kit 3AH, includes three gas sensors (O <sub>2</sub> , CO, NO), 180 mm Probe rated to 800 °C (1472 °F) with 2 m dual hose, ABS hard plastic carrying case, rubber holster, water trap with filter, charger with plug set, USB-C cable, quick start guide, calibration certificate
Si-CA 130 Kit 3BS	27513	Si-CA 130 Gas Analyzer Kit 3BS, includes three gas sensors (O <sub>2</sub> , CO, NO), 300 mm Probe rated to 800 °C (1472 °F) with 3 m dual hose, vinyl carrying case, rubber holster, water trap with filter, charger with plug set, USB-C cable, quick start guide, calibration certificate
Si-CA 130 Kit 3BH	27514	Si-CA 130 Gas Analyzer Kit 3BH, includes three gas sensors (O <sub>2</sub> , CO, NO), 300 mm Probe rated to 800 °C (1472 °F) with 3 m dual hose, ABS hard plastic carrying case, rubber holster, water trap with filter, charger with plug set, USB-C cable, quick start guide, calibration certificate
Si-CA 130 Kit 3LowAS	27515	Si-CA 130 Gas Analyzer Kit 3LowAS, includes three gas sensors (O <sub>2</sub> , CO, Low NO), 180 mm Probe rated to 800 °C (1472 °F) with 2m dual hose, vinyl carrying case, rubber holster, water trap with filter, charger with plug set, USB-C cable, quick start guide, calibration certificate
Si-CA 130 Kit 3LowAH	27516	Si-CA 130 Gas Analyzer Kit 3LowAH, includes three gas sensors (O <sub>2</sub> , CO, Low NO), 180 mm Probe rated to 800 °C (1472 °F) with 2 m dual hose, ABS hard plastic carrying case, rubber holster, water trap with filter, charger with plug set, USB-C cable, quick start guide, calibration certificate
Si-CA 130 Kit 3LowBS	27517	Si-CA 130 Gas Analyzer Kit 3LowBS, includes three gas sensors (O <sub>2</sub> , CO, Low NO), 300 mm Probe rated to 800 °C (1472 °F) with 3 m dual hose, vinyl carrying case, rubber holster, water trap with filter, charger with plug set, USB-C cable, quick start guide, calibration certificate
Si-CA 130 Kit 3LowBH	27518	Si-CA 130 Gas Analyzer Kit 3LowBH, includes three gas sensors (O <sub>2</sub> , CO, Low NO), 300 mm Probe rated to 800 °C (1472 °F) with 3 m dual hose, ABS hard plastic carrying case, rubber holster, water trap with filter, charger with plug set, USB-C cable, quick start guide, calibration certificate

## Maintenance

We carry out calibration, adjustment and maintenance of your devices to guarantee a consistent and accurate level of quality of your measurements. As part of Quality Assurance Standards, we recommend annual recalibration and maintenance check-up.

## Warranty

Devices have 2-year guarantee against any manufacturing defect (return to our After-Sales Service required for appraisal).

