



Carbon Monoxide Analyzer

for Exhaust Gas Applications



Emissions Analysis

P/N: 0019-9376 | December 2019 Revision 0

User
Manual

WARRANTY POLICY

Bacharach, Inc. warrants to buyer that at the time of delivery this product will be free from defects in material and manufacture and will conform substantially to Bacharach, Inc.'s applicable specifications. Bacharach's liability and buyer's remedy under this warranty are limited to the repair or replacement, at Bacharach's option, of this product or parts thereof returned to seller at the factory of manufacture and shown to Bacharach, Inc.'s reasonable satisfaction to have been defective; provided that written IMPORTANT of the defect shall have been given by buyer to Bacharach, Inc. within two (2) years after the date of delivery of this product by Bacharach, Inc.

Bacharach, Inc. warrants to buyer that it will convey good title to this product. Bacharach's liability and buyer's remedy under this warranty of title are limited to the removal of any title defects or, at the election of Bacharach, to the replacement of this product or parts thereof that are defective in title.

THE FOREGOING WARRANTIES ARE EXCLUSIVE AND ARE GIVEN AND ACCEPTED IN LIEU OF (I) ANY AND ALL OTHER WARRANTIES, EXPRESS OR IMPLIED, INCLUDING WITHOUT LIMITATION THE IMPLIED WARRANTIES OF MERCHANTABILITY AND FITNESS FOR A PARTICULAR PURPOSE: AND (II) ANY OBLIGATION, LIABILITY, RIGHT, CLAIM OR REMEDY IN CONTRACT OR TORT, WHETHER OR NOT ARISING FROM BACHARACH'S NEGLIGENCE, ACTUAL OR IMPLIED. The remedies of the buyer shall be limited to those provided herein to the exclusion of any and all other remedies including, without limitation incidental or consequential damages. No agreement varying or extending the foregoing warranties, remedies or this limitation will be binding upon Bacharach, Inc. unless in writing, signed by a duly authorized officer of Bacharach.

Register Your Warranty by Visiting: www.mybacharach.com

SERVICE POLICY

Bacharach, Inc. maintains a service facility at the factory. Some Bacharach distributors / agents may also have repair facilities; however, Bacharach assumes no liability for service performed by anyone other than Bacharach personnel. Repairs are warranted for 90 days after date of shipment (*sensors, pumps, filters and batteries have individual warranties*). Should your analyzer require non-warranty repair, you may contact the distributor from whom it was purchased or you may contact Bacharach directly.

If Bacharach is to do the repair work, send the monitor, prepaid, to the closest service center.

Prior to shipping equipment to Bacharach, visit www.mybacharach.com for an Returned Merchandise Authorization Number (RMA #). All returned goods must be accompanied with an RMA #. Pack the equipment securely (*in its original packing, if possible*), as Bacharach cannot be held responsible for any damage incurred during shipping to our facility.

Always include your RMA #, shipping address, telephone number, contact name, billing information and a description of the defect as you perceive it. You will be contacted with a cost estimate for expected repairs prior to the performance of any service work. For liability reasons, Bacharach has a policy of performing all needed repairs to restore the monitor to full operating condition.

IMPORTANT

Product improvements and enhancements are on-going, therefore the specifications and information contained in this document may change without IMPORTANT.

Bacharach, Inc. shall not be liable for errors contained herein or for incidental or consequential damages in connection with the furnishing, performance, or use of this material.

No part of this document may be photocopied, reproduced, or translated to another language without the prior written consent of Bacharach, Inc.

Copyright © 2019, Bacharach, Inc., All Rights Reserved.

BACHARACH, Fyrite®, True Spot, Monoxor®, and B-Smart® are registered trademarks of Bacharach, Inc. All other trademarks, trade names, service marks and logos referenced herein belong to their respective companies.

Contents

Overview 5

- 1.1 Introduction..... 5
- 1.2 Iconography..... 5
- 1.3 General Safety Statements..... 6
- 1.4 Product Overview 6
- 1.5 Components 11
- 1.6 Features 12
- 1.7 Monoxor® XR Sales Combinations 13
- 1.8 Specifications 13

Setup 15

- 2.1 Connecting the Probe..... 15
- 2.2 Front Panel Buttons..... 16
- 2.3 Power Options..... 17
- 2.4 Turning on the Monoxor® XR..... 19

Configuration 20

- 3.1 Menu Structure Overview..... 20
- 3.2 The Warm-Up Sequence..... 20
- 3.3 Main Menu 21
- 3.4 Ambient CO Menu 23
- 3.5 Differential Temperature Menu..... 25
- 3.6 Memory Options Menu 26
- 3.7 Setup Menu 27
- 3.8 Calibration Menu 35
- 3.9 Diagnostics Menu 36
- 3.10 Status Menu..... 37

Operation..... 38

- 4.1 Overview 38
- 4.2 Taking a Gas Sample..... 39
- 4.3 The RUN and Hold Screens..... 40
- 4.4 CO Trending Graph 41

- 4.5 Ending a Test 42
- 4.6 Differential Temperature Measurement 42
- 4.7 Timed Ambient CO Testing 43
- 4.8 Printing Using the Optional IrDA Printer 44
- 4.9 Turning Off the Analyzer 46
- 4.10 PC Interface and Fyrite® User Software 47

Care & Maintenance 48

- 5.1 Serviceability 48
- 5.2 Cleaning the Probe 49
 - 5.2.1 Equipment Required 49
 - 5.2.2 Procedure 50
- 5.3 Filter Replacement 51
- 5.4 CO Sensor Replacement 52
 - 5.4.1 Accessing the CO Sensor 52
 - 5.4.1 CO Sensor Replacement Procedure 53
 - 5.4.2 B-Smart® CO Sensor Replacement 54
- 5.5 Temperature Calibration 55
 - 5.5.1 Materials Required 55
 - 5.5.2 Temperature Calibration Procedure 55
- 5.6 CO Sensor Calibration 57
 - 5.6.1 Materials Required 57
 - 5.6.2 CO Manual Zero Procedure 57
 - 5.6.3 CO Sensor Span Procedure 58
- 5.7 T-Ref Sensor Calibration 59

Troubleshooting 60

- 6.1 Error and Warning Messages 60
- 6.2 Replacement Parts 61
- 6.3 Accessories 61
- 6.4 Instrument Identification 62

Additional Information 63

- 7.1 Bacharach Combustion App 63
- 7.2 Service Centers 63

1. Overview







1.1	Introduction	6
1.2	Iconography.....	7
1.3	General Safety Statements.....	7
1.4	Product Overview	8
1.5	Components	12
1.6	Features	14
1.7	Monoxor® XR Sales Combinations.....	15
1.8	Specifications	15

1.1 Introduction

Thank you for investing in a Bacharach Monoxor® XR Carbon Monoxide (CO) Analyzer. To assure proper use and operator safety, please read the contents of this manual for important information on the operation and maintenance of the analyzer.

 **IMPORTANT:** Before using this product, carefully read and strictly follow the instructions in the manual.

1.2 Iconography

Alert	Icon	Description
DANGER		Imminently hazardous situation which, if not avoided, will result in death or serious injury.
WARNING		Potentially hazardous situation which, if not avoided, could result in death or serious injury.
WARNING		Potential electrical shock hazard which, if not avoided, could result in death or serious injury.
WARNING		Hot surface which, if not avoided, could result in physical injury or damage to the product.
CAUTION		Potentially hazardous situation which, if not avoided, could result in physical injury or damage to the product or environment. It may also be used to alert against unsafe practices.
IMPORTANT		Additional information on how to use the product.

1.3 General Safety Statements



WARNING: This analyzer is not intended to be used as a safety device.



WARNING: When testing a combustion system, a full visual inspection should be performed to ensure its safe operation.



CAUTION: This analyzer is not intended to be used on a continuous basis.



CAUTION: Do not store instrument or its sensors with solvents or products that contain solvents.



CAUTION: Except for sensor and battery replacement, this analyzer should only be opened and/or serviced by authorized Bacharach personnel. Failure to comply may void the warranty.



HAZARDOUS AREA WARNING: This instrument has not been designed to be intrinsically safe for use in areas classified as hazardous locations. For your safety, **DO NOT** use it in hazardous (*classified*) locations.



CAUTION: Do not use flammable or combustible substances (*like carburetor fluid used for cleaning the probe*) near an open flame.



CAUTION: When the instrument is used in an inefficient oil-fueled appliance where there is a high emission of soot, the probe's sample filter may become clogged. Before every use check the filter to confirm it is clean or replace it with a new filter.

1.4 Product Overview

The Monoxor® XR is a portable hand-held carbon monoxide (CO) analyzer for use in commercial and industrial applications. It is intended to be used by:

- Engine & service technicians
- Maintenance personnel
- Safety inspectors
- Propane forklift operators

to detect and display concentrations of CO gas between 0 and 80,000 ppm. The analyzer is capable of testing for CO in both ambient room air and in the exhaust stream of fossil-fuel fired combustion systems.

Ambient CO

CO gas is colorless, odorless, and deadly. Test CO levels in suspect Pambient air. Perform an automated 15-minute test, watch live values, or view a dynamic CO graph over time.

Fig. 1-1: Perform an Ambient CO test and watch live values, or view a dynamic CO graph over time

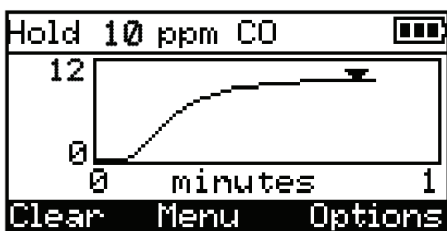

The analyzer detects and displays the presence of CO by first drawing in a gas sample from the area being tested by the analyzer’s built-in motorized pump. The gas sample is next directed into a sensor chamber where the sample is analyzed for the presence of CO. If CO is detected, the CO ppm level is given on the analyzer’s main display. A trending screen (*accessible from the RUN screen by using the right or left arrow key*) shows dynamic CO levels graphed over a programmable time period (*from 30 seconds to 15 minutes*). In addition to the visual notifications, you can set a CO alarm limit, above which an audible alarm buzzer will beep repeatedly. An audible alarm with a slower beep frequency occurs when the batteries are low.

A backlight enables the operator to read the display in dimly-lit areas. The displays and menus are available in multiple languages (*English, French and Spanish*).

A permanent record of the detected CO level, along with the current time and date, can be made by using the optional wireless IrDA printer. Test records can also be saved in memory.

An ambient CO feature takes approximately 15-minutes to complete and provides a minute-by-minute snapshot of CO readings, as well as a “Max CO” value that represents the highest CO reading measured during the entire test. Results can be saved to memory and/or printed.

A calibration reminder can be set to occur every 6, 8, 10, 12, or 15-months after the last calibration. (*Select “Never” to disable this feature.*) Regular calibration periods of 6 months to 1 year are recommended. The calibration reminder value sets a time period after which the analyzer displays a calibration reminder message during warm-up.

To avoid the need for manual CO sensor calibrations, the B-Smart® Sensor program is supported with the Monoxor® XR. After enrolling in the program, pre-calibrated replacement B-Smart® CO sensors are shipped at predetermined intervals of your choice.

- Choose a program start date that best suites your needs.
- Receive a pre-calibrated B-Smart® sensor.
- Return your old sensor in a returnable, pre-labeled container.

Benefits include no downtime, self calibration, convenience, and cost savings. For additional information about the B-Smart® Calibration Program, contact Bacharach at 1-800-736-4666 or email help@mybacharach.com.

A programmable inactivity timeout causes the analyzer to initiate shutdown mode if no key presses occur for the specified time period. If the analyzer initiates automatic shutdown or is turned OFF manually while a high level of CO is still present within the unit, the automatic CO purge feature forces the analyzer’s pump to remain on until the detected CO level drops below 50 ppm.

The instrument is supplied with the following components:

- Probe and hose assembly
- Four disposable “AA” alkaline batteries
- Hard carrying case
- Factory-calibrated and installed CO sensor

Depending on the model and kit, some or all of the following components are included:

- Spare filters
- Fyrite® User Software (*FUS*)
- USB cable (*type A to mini B*)
- Infrared Data Association (*IrDA*) printer with four disposable “AA” alkaline batteries
- Printer paper

Using the optional thermocouples, ambient and flue gas temperatures can be measured. Additionally, the Monoxor® XR can calculate a differential temperature based on two sampled temperatures (*T1 and T2*) using the optional stack thermocouple or optional probe assembly (*with built-in thermocouple*). After you take the two sample readings, the differential value (*T1-T2*) is calculated, optionally saved in memory, displayed on the main run screen, and is shown on printouts.

Fig. 1-2: Differential value is calculated, saved in memory, displayed on the main run screen, or shown on printouts

Tri-State Inspection
123 Elm Street
Kensington, PA 12345

BACHARACH

BACHARACH, Inc.
Monoxor Plus
5M AB1234

Time: 15:55:05
Date: 06/20/13

CO: 0 ppm
Max: 1 ppm
Min: 0 ppm
Temp: 79 F °
TI-T2: 54 F °

Comments:

CO Alarm

Low Battery Alarm

Run

CO 0 ppm
Max 3 ppm
Min 0 ppm
Temp 87 °F

Print Menu Save

Hold

CO 0 ppm
Max 3 ppm
Min 0 ppm
Temp 87 °F

Print Menu Save

English
Français
Español

Calibrate !!!

August
21
SMTWHFS

Hold 34 ppm CO

100
0 minutes 1

Clear Menu Options

Auto Power Down
&
Auto CO Purge

Fig. 1-3: Components of the Optional Probe Assembly

#	Description
1	Temperature Port
2	USB Port
3	Sample Gas Port
4	Sample Gas Hose
5	USB Cable (Optional)
6	Water Trap and Filter Assembly
7	Probe Handle
8	Probe Tube

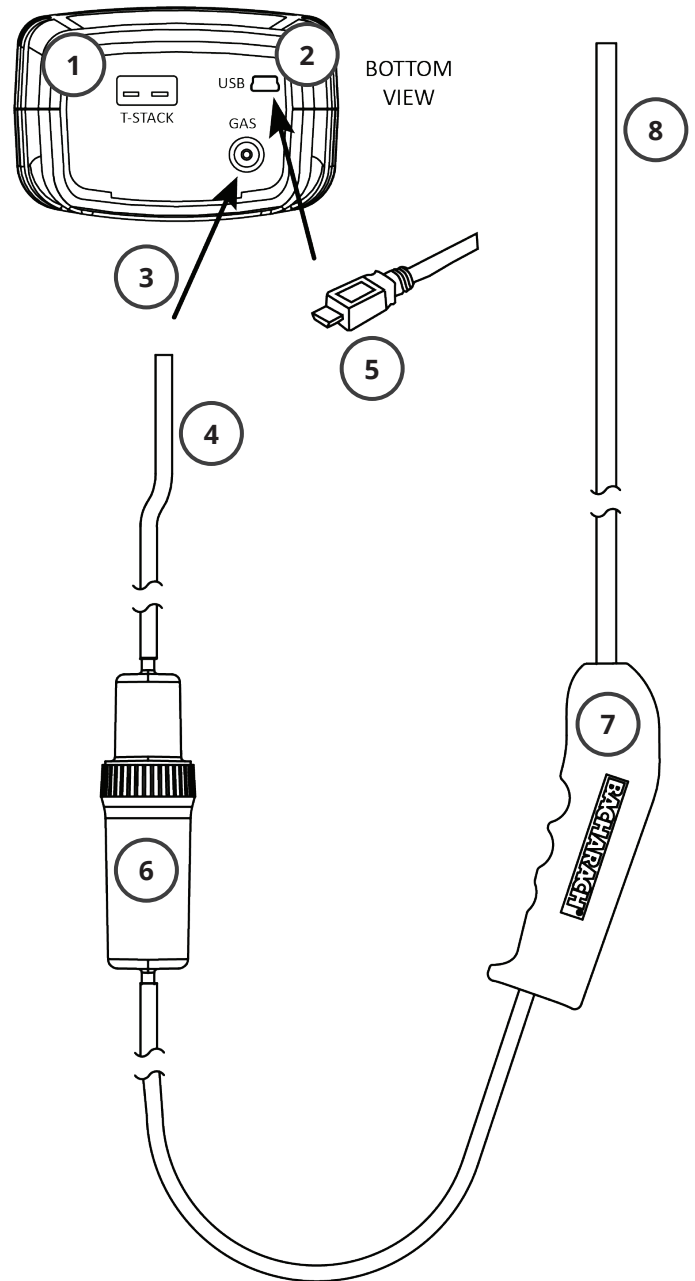

1.5 Components

Fig. 1-4: Components of the Optional Probe Assembly

#	Description
1	Monochrome Display (LCD) with Backlight
2	Function Keys (F1, F2, F3) <ul style="list-style-type: none"> Context sensitive Functions shown at bottom of display
3	Up and Down Arrow Keys <ul style="list-style-type: none"> Scroll up / down through a list
4	<ul style="list-style-type: none"> Increase / decrease alphanumeric values
5	Left and Right Arrow Keys <ul style="list-style-type: none"> Scroll left / right through a field
6	<ul style="list-style-type: none"> Jump to top / bottom of list Access the trending screen
7	Enter Key <ul style="list-style-type: none"> Choose highlighted item Accept value / character
8	Escape Key <ul style="list-style-type: none"> Cancel most operations and display previous screen
9	Power / Backlight Key <ul style="list-style-type: none"> Press & release: Power ON Press & release: Toggle backlight ON / OFF Press & hold (2 secs): Begin power OFF sequence
10	Run / Hold Key <ul style="list-style-type: none"> While in HOLD: Turn on pump, display RUN screen, and begin test. While in RUN: Turn off pump, display HOLD screen and last set of test data. In most menus: Display HOLD screen. During power down: Return display to HOLD screen (cancel power down).

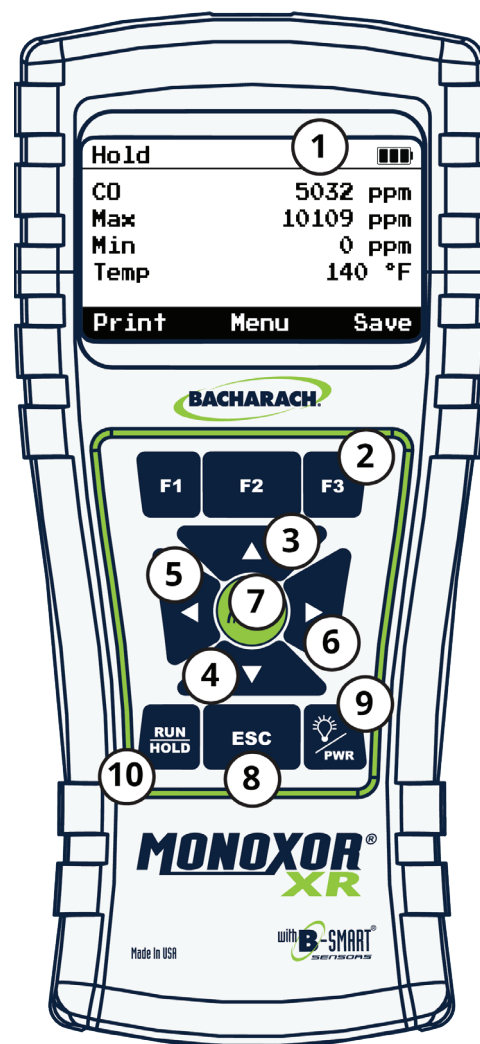

1.6 Features

Sensors

- Field-replaceable electrochemical sensor (*B-Smart® CO*)
- Temperature measurement using a Type K thermocouple (*with probe assembly 19-7111*)

Power

- 4 × AA alkaline batteries (*included*)
- 4 × AA lithium batteries
- 4 × AA rechargeable batteries (*externally charged*)
- Low battery warning

Testing Features

- Complete test results (*100 sets*) can be stored, recalled, displayed, and printed
- Time and date stamping of test results
- Differential temperature
- Secure calibration function (*password protected*)
- Auto power-off feature with sensor purge feature
- Status and diagnostic menus
- Ambient CO

User Customizations

- Multi-language interface
- Auto/Manual zero functions for the CO sensor
- Customized user information (*3 × lines of 20 characters*)
- Customized logo on printouts (*192 × 384 pixels*)
- Temperature unit selection

Hardware

- Exhaust probe / standard probe with hose assembly for gas transport
- Sample pump to provide gas sample delivery
- Backlit monochrome graphic LCD
- Hard carrying case
- USB 2.0 (*mini-B connection*) for PC interface and communications

PC Interface

- USB cable (*Type A to Mini B*)
- Fyrite® User Software (*FUS*) (*Windows compatible*)

1.7 Monoxor® XR Sales Combinations

Components	Basic & Standard Probe (P/N: 0019-8119)	Reporting & Standard Probe (P/N: 0019-8120)	Basic & Exhaust Probe (P/N: 0019-8121)	Reporting & Exhaust Probe (P/N: 0019-8122)
Standard Probe	✓	✓		
Exhaust Probe			✓	✓
Temperature	✓	✓	✓	✓
Quick Start Guide	✓	✓	✓	✓
B-Smart® CO Sensor	✓	✓	✓	✓
Hard Case	✓	✓	✓	✓
Printer		✓		✓
PC Software		✓		✓
USB Cable		✓		✓

1.8 Specifications

Measurement	Range	Resolution	Accuracy	Response Time (T90)
CO	0 to 80,000 ppm	20 ppm	±20 ppm (0 to 200 ppm) ±10% reading (201 to 80,000)	< 40 sec
Temp	-20° to 650° C (-4° to 1202° F)	1° C (1° F)	±2° C (0° to 124° C) ±3° C (125° to 249° C) ±4° C (250° to 400° C)	< 50 sec

Specification	Description	
Temperature	Storage: -20° to 50° C (-4° to 122° F) 0° to 20° C (32° to 68° F) optimal Operation: -5° to 45° C (23° to 113° F) Reference: 20° ± 2° C (68° ± 4° F)	
Humidity	Storage: 15 to 90% RH, non-condensing Operation: 15 to 95% RH, non-condensing Reference: 45 ± 10% RH, non-condensing	
Pressure	1 atmosphere ± 10%	
Weight	16 ounces (454 g) with batteries	
Dimensions (H × W × D)	8.0" × 3.6" × 2.3" (20.3 cm × 9.1 cm × 5.8 cm)	
Warm-up Time	60 seconds	
Gas Sample Flow Rate	300 to 700 cc/min	
Sensors	CO Sensor: Electrochemical (P/N: 0024-0997) B-Smart CO Sensor: Electrochemical (P/N: 0024-1795) Temperature: K-Type thermocouple	
Product Approvals and Regulatory Compliance	EN50270: 2015 (CE Mark) EMC tested in accordance with European Directive RoHS Compliance	
Case Construction	High impact ABS plastic with co-molded rubber. Optional protective rubber boot with molded-in magnets.	
Display	Monochrome with backlight	
USB Connector	Mini B (USB 2.0)	
Memory	100 locations for storing test results	
IrDA Port	Protocol: IrDA-SIR Data Bits: 8 Stop Bits: 1 Baud Rate: 9600 Parity: None	
Power Supply Options	Batteries (4 AA)	Type: Disposable Alkaline (Included) Duration: 15 hours min, continuous max draw
		Type: Disposable Lithium Duration: 20 hours, continuous max draw
		Type: Rechargeable Duration: 8 hours, continuous max draw

2. Setup

2.1	Connecting the Probe	17
2.2	Front Panel Buttons.....	18
2.3	Power Options.....	19
2.4	Turning on the Monoxor® XR	21

2.1 Connecting the Probe

A rigid stainless steel probe with handle is connected to a flexible hose with an integral water trap/filter and is used to draw a gas sample into the analyzer from the room, grilles, diffusers, and furnace flues.

1. Inspect the flexible hose for cracks. If a hose is defective, replace the entire probe assembly.
2. Before using the analyzer, check that the water trap/filter is clean and dry. If necessary, dry out the trap and replace the filter element.
3. Push the probe's "sample gas" tubing onto the GAS inlet connector.

Fig. 2-1: Connecting the Probe

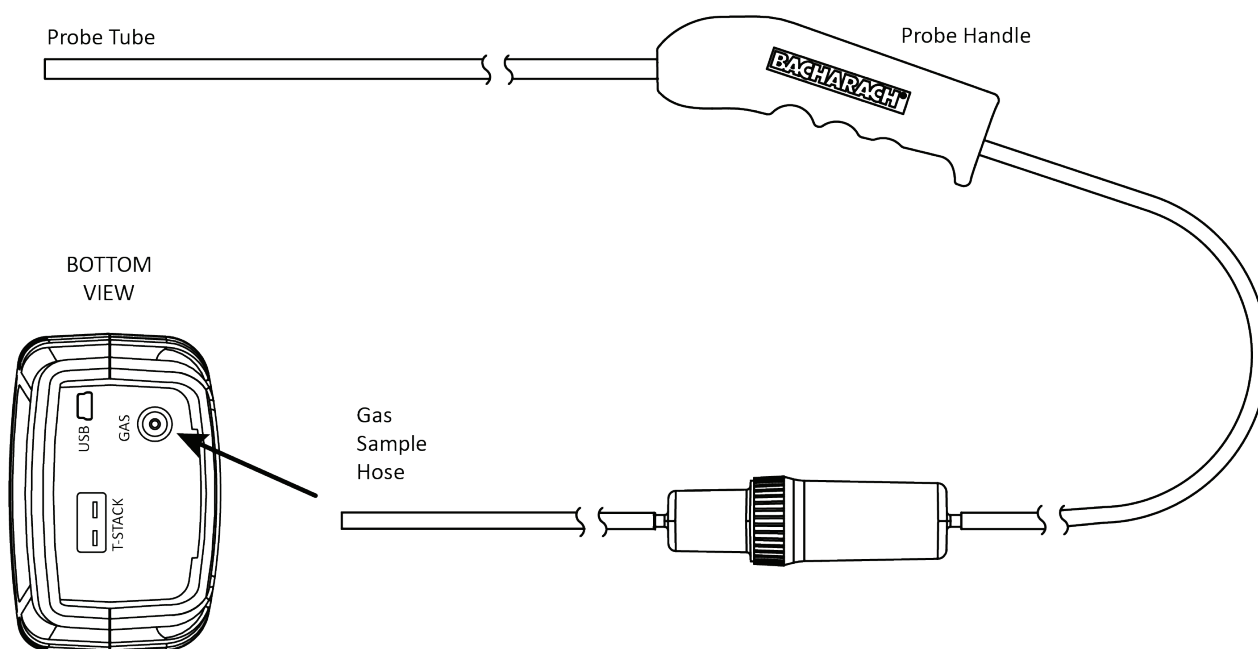

2.2 Front Panel Buttons

Fig. 2-2: Front Panel Buttons

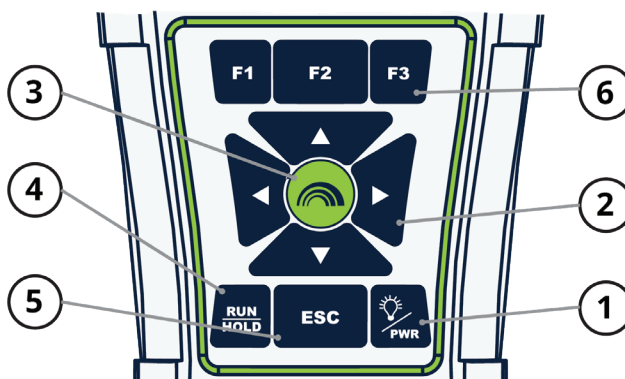

#	Description
1	<ul style="list-style-type: none"> Powers the analyzer ON and OFF. Hold this button down for at least 2 seconds to turn the power OFF. Toggles the backlight ON and OFF while the analyzer is turned ON.
2	<ul style="list-style-type: none"> UP (▲), DOWN (▼), LEFT (◀), and RIGHT (▶) arrows are context-specific navigation buttons for the menus. UP (▲) and DOWN (▼) arrow buttons scroll to menu options that are hidden from view (when a side scroll bar is displayed indicating additional information). UP (▲) and DOWN (▼) arrow buttons cause the displayed value to increase or decrease accordingly. LEFT (◀) and RIGHT (▶) arrow buttons jump to the top and bottom of lists, respectively. LEFT (◀) and RIGHT (▶) arrow buttons position the active cursor on specific elements of a value to be changed. LEFT (◀) arrow button displays the CO Trending screen from the Run/Hold screen. RIGHT (▶) arrow button displays the QR code screen from the hold screen.
3	<ul style="list-style-type: none"> The ENTER button. Performs the action selected.
4	<ul style="list-style-type: none"> While in the HOLD screen, turns the sample pump on, displays the RUN screen, and begins a test. While in the RUN screen, turns the sample pump off, displays the HOLD screen and the last set of data. Displays the HOLD screen while pressing it from most menus. Returns the display to the HOLD screen while pressing it during the shutdown sequence.
5	<ul style="list-style-type: none"> The ESC button cancels most operations and displays the previous screen.
6	<ul style="list-style-type: none"> Pressing function keys accepts the corresponding function defined above that key at the bottom of the display (for example, PRINT, SAVE, MENU, etc.).

2.3 Power Options

Power options include:

- Disposable AA alkaline batteries (*included*)
- Disposable AA lithium (*Li*) batteries
- Externally charged rechargeable NiMH batteries.

Check the Monoxor® XR for sufficient power prior to each use. Replace the batteries if the low (*or replace*) battery symbol appears in the upper right corner of the Monoxor® XR screen.

Batteries (4 AA, Fresh or Fully Charged)	Estimated Life Span in Hours (Continuous, Pump On)
Alkaline (<i>disposable</i>)	15 hours
Lithium (<i>disposable</i>)	20 hours
Rechargeable	8 hours

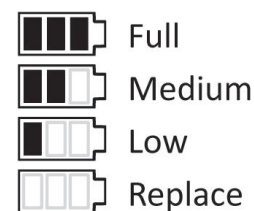

Replace batteries as follows:

1. Remove the battery cover from the back of analyzer.
2. If old batteries are installed, remove them and properly discard them.
3. Observing the polarity markings inside the battery compartment, install four 'AA' disposable (*alkaline or lithium*) batteries or four fully-charged (*externally charged*) AA rechargeable NiMH batteries.
4. Replace the battery cover.



NOTE: The Monoxor® XR does NOT charge rechargeable batteries.



NOTE: The Monoxor® XR sounds a series of beeps to indicate that the batteries need to be replaced.

Fig. 2-3: Removing the Battery Cover

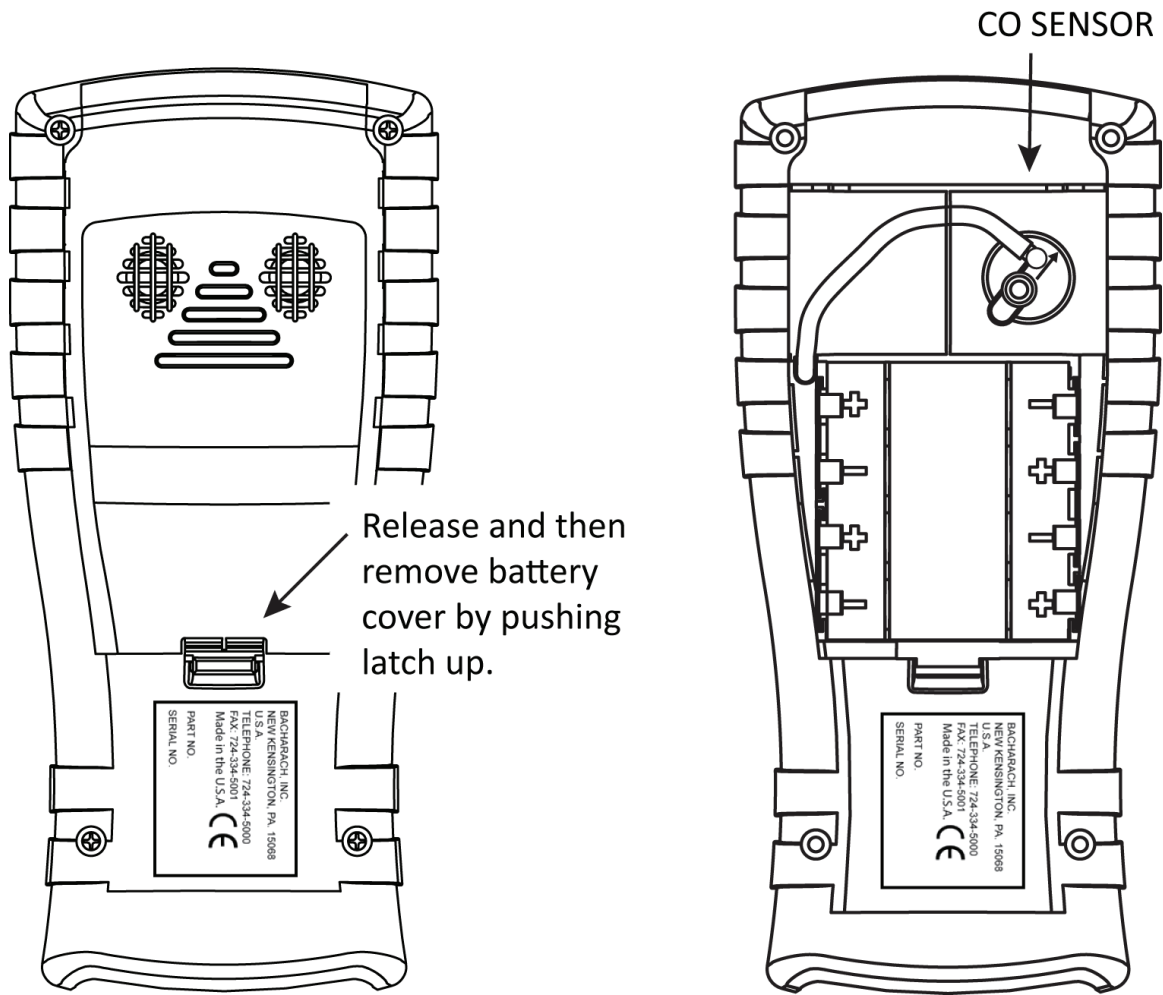

2.4 Turning on the Monoxor® XR

To turn on the Monoxor® XR, press the PWR button.



NOTE: After turning on the Monoxor® XR, it performs a warm-up procedure which includes an auto-zero procedure (*when in Auto Zero mode*) for the sensors (*see section 1.8 and 3.7*). For this reason, be sure to turn on the Monoxor® XR in a clean air environment. When the analyzer is in CO Manual mode, the analyzer will indicate the background CO during startup.

3. Configuration

3.1	Menu Structure Overview	22
3.2	The Warm-up Sequence	22
3.3	Main Menu	23
3.4	Ambient CO Menu	25
3.5	Differential Temperature Menu.....	27
3.6	Memory Options Menu	28
3.7	Setup Menu	29
3.8	Calibration Menu	37
3.9	Diagnostics Menu	38
3.10	Status Menu.....	39

3.1 Menu Structure Overview

Menus and the items contained within them are described in a top-down fashion, starting from the startup screens and working sequentially through the menus and menu items.

3.2 The Warm-Up Sequence

Menus and the items contained within them are described in a top-down fashion, starting from the startup screens and working sequentially through the menus and menu items.

Boot Sequence	Description
<p>Version: V1.00 Model: 19-7163 Serial: AB1234</p>	Splash screen shows the Bacharach logo with version, model number, and serial number information. This screen is displayed for approximately 3 seconds.
<p>Version: V1.00 Model: 19-7163 Serial: AB1234</p>	Splash screen shows the Bacharach logo with version, model number, and serial number information. This screen is displayed for approximately 3 seconds.

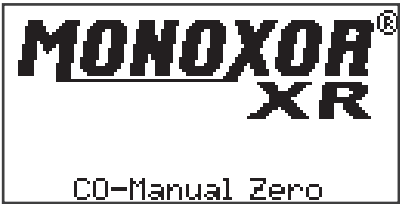
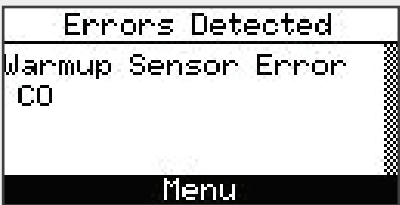
Boot Sequence	Description
 	<p>A warm-up screen is displayed during which the instrument is purged and initialized. The current zero setting for the CO sensor (<i>Auto-Zero or Manual Zero</i>) is displayed briefly, followed by a countdown timer during initialization (<i>see section "3.7 Setup Menu"</i>.)</p>
	<p>If any errors are detected during warm-up, the corresponding error messages are displayed, after which the user presses F2 to go to the Menu, or presses RUN/HOLD to go to the Hold screen. (<i>See section "6.1 Error and Warning Messages" for a list of error messages.</i>)</p>



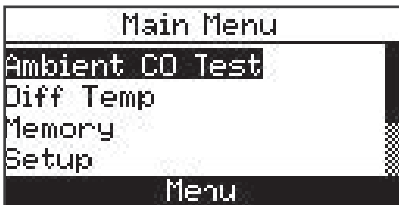
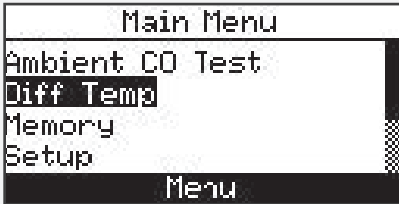

3.3 Main Menu

Display the Main Menu by pressing the F2 key. Note that features and items displayed in menus are model dependent. Your screens may vary.

Main Menu	Function
	<p>Access the Ambient CO Test Menu (<i>see section "3.4 Ambient CO Menu"</i>)</p> <ul style="list-style-type: none"> • Initiate a 15-minute CO test • Get reading every minute and max CO reading • Print/Save 16 readings and max CO
	<p>Access the Differential Temperature Menu (<i>see section "3.5 Differential Temperature Menu"</i>)</p> <ul style="list-style-type: none"> • Display current temperature reading. • Display differential temperature readings • Save differential temperature information

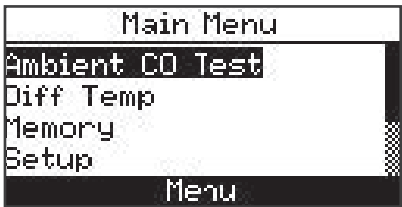
Main Menu	Function
<p>A screenshot of the Main Menu with the following options: Ambient CO Test, Diff Temp, Memory (highlighted), and Setup. The word 'Menu' is at the bottom.</p>	<p>Access the Memory Options Menu (see section "3.6 Memory Options Menu").</p> <ul style="list-style-type: none"> • Access previously saved test results • Delete all previously saved test results
<p>A screenshot of the Main Menu with the following options: Ambient CO Test, Diff Temp, Memory, and Setup (highlighted). The word 'Menu' is at the bottom.</p>	<p>Access the Setup Menu (see section "3.7 Setup Menu").</p> <ul style="list-style-type: none"> • Edit/view instrument preference • Edit/view system parameters • Edit/view test parameters
<p>A screenshot of the Main Menu with the following options: Setup, Calibration (highlighted), Diagnostics, and Status. The word 'Menu' is at the bottom.</p>	<p>Access the Calibration Password Screen and the Calibration Menu (see section "3.8 Calibration Menu").</p> <ul style="list-style-type: none"> • Calibrate sensors
<p>A screenshot of the Main Menu with the following options: Setup, Calibration, Diagnostics (highlighted), and Status. The word 'Menu' is at the bottom.</p>	<p>Access the Diagnostics Menu (see section "3.9 Diagnostics Menu").</p> <ul style="list-style-type: none"> • View "run" meters and system diagnostic values • Fresh air diagnostics
<p>A screenshot of the Main Menu with the following options: Setup, Calibration, Diagnostics, and Status (highlighted). The word 'Menu' is at the bottom.</p>	<p>Access the Device Status Menu (see section "3.10 Status Menu").</p> <ul style="list-style-type: none"> • Access the software date, model number, serial number, and version information

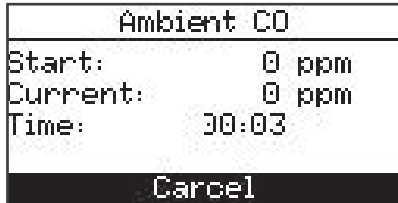
3.4 Ambient CO Menu

Ambient CO	Function
	<p>Access the Ambient CO Menu. When initiated, the Ambient CO feature monitors CO values continuously and captures a reading every minute for 15 minutes (a total of 16 readings from t_0 to t_{15}). Press ENTER to initiate the Ambient CO test. This begins a 15-minute test cycle, during which a status screen is displayed. It shows the starting ambient CO value, the current CO value, and the elapsed time into the test.</p> <div style="display: flex; justify-content: space-around;"> <div data-bbox="692 640 1090 842">  </div> <div data-bbox="1115 640 1513 842">  </div> </div> <div style="margin-top: 20px;">  </div> <hr/> <p>i NOTE: Press the F2 key to cancel a test in progress.</p> <hr/> <p>After the test is complete, the Ambient CO Summary screen is displayed. This is a scrollable window that shows the 16 CO “snapshot” readings, as well as the maximum CO reading that was sampled during the entire test.</p> <hr/> <p>i NOTE: The Max CO Reading is the highest sampled CO reading – even if the reading was taken in between one of the sample “snapshot” readings.</p> <hr/>

Ambient CO cont.	Function																																					
<table border="1"> <thead> <tr> <th colspan="2">Main Menu</th> </tr> </thead> <tbody> <tr> <td>Ambient CO Test</td> <td></td> </tr> <tr> <td>Diff Temp</td> <td></td> </tr> <tr> <td>Memory</td> <td></td> </tr> <tr> <td>Setup</td> <td></td> </tr> <tr> <td colspan="2" style="text-align: center;">Menu</td> </tr> </tbody> </table>	Main Menu		Ambient CO Test		Diff Temp		Memory		Setup		Menu		<table border="1"> <thead> <tr> <th colspan="2">Ambient CO Summary</th> </tr> </thead> <tbody> <tr> <td>Time(min)</td> <td>CO(ppm)</td> </tr> <tr> <td>0</td> <td>3</td> </tr> <tr> <td>1</td> <td>3</td> </tr> <tr> <td>2</td> <td>3</td> </tr> <tr> <td colspan="2" style="text-align: center;">Print Menu Save</td> </tr> </tbody> </table>	Ambient CO Summary		Time(min)	CO(ppm)	0	3	1	3	2	3	Print Menu Save		<table border="1"> <thead> <tr> <th colspan="2">Ambient CO Summary</th> </tr> </thead> <tbody> <tr> <td>13</td> <td>0</td> </tr> <tr> <td>14</td> <td>0</td> </tr> <tr> <td>15</td> <td>0</td> </tr> <tr> <td>Max CO</td> <td>0</td> </tr> <tr> <td colspan="2" style="text-align: center;">Print Menu Save</td> </tr> </tbody> </table>	Ambient CO Summary		13	0	14	0	15	0	Max CO	0	Print Menu Save	
Main Menu																																						
Ambient CO Test																																						
Diff Temp																																						
Memory																																						
Setup																																						
Menu																																						
Ambient CO Summary																																						
Time(min)	CO(ppm)																																					
0	3																																					
1	3																																					
2	3																																					
Print Menu Save																																						
Ambient CO Summary																																						
13	0																																					
14	0																																					
15	0																																					
Max CO	0																																					
Print Menu Save																																						
<p>The test results can be printed by pressing F1 and saved to memory (with a time and date stamp) by pressing F3. Press F2 to return to the menu.</p> <hr/> <p> NOTE: Any over-range CO values (e.g., CO > 80,000 ppm) are displayed as "OVR".</p> <hr/>																																						

3.5 Differential Temperature Menu











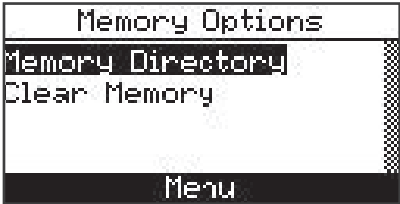
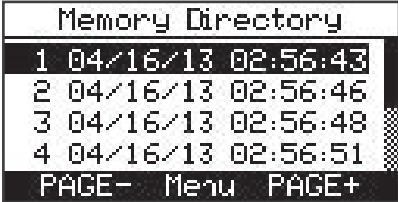

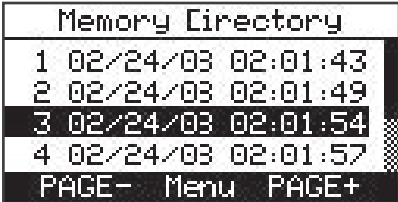
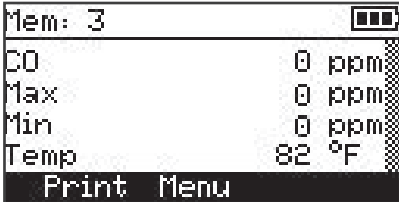
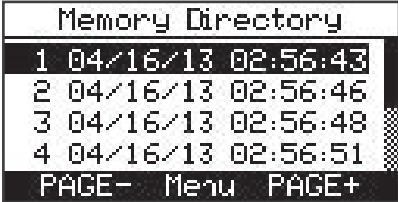

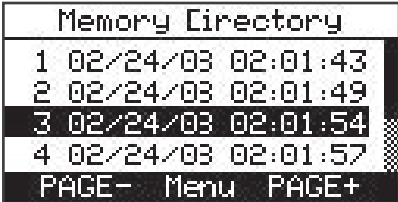
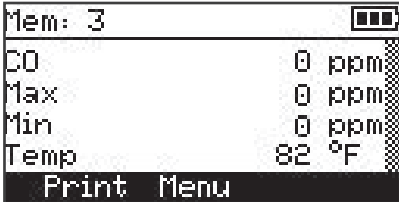
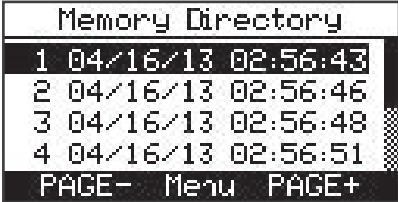

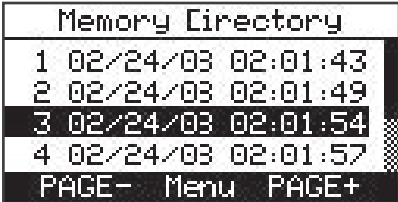
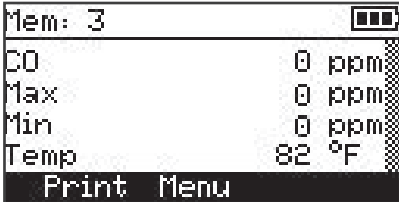

Display the Main Menu by pressing the F2 key. Note that features and items displayed in menus are model dependent. Your screens may vary.

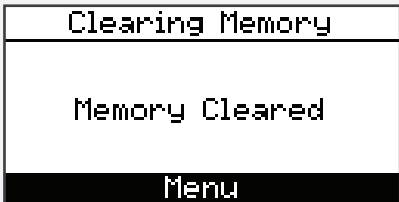
Diff Temp	Function
<pre> Main Menu Ambient CO Test Diff Temp Memory Setup Menu </pre>	<p>The Diff Temp option is used to calculate a differential temperature based on two sampled temperatures.</p> <p>When this option is first selected, the current temperature (Temp) is displayed. Values for T1 and T2 will show no readings until they are saved by the operator, after which a differential value (T1-T2) will also be displayed.</p> <p>With temperature #1 (T1) selected, position the thermocouple in the target location, and wait for the temperature reading (Temp) to stabilize. Press the SAVE button to temporarily store the T1 value. Repeat these steps for the temperature #2 (T2). After saving both values, the "T1-T2" differential temperature will be displayed. At this point, you may press SAVE again to save the differential temperature value to memory so that it can be retrieved and/or printed later.</p>
	<pre> Diff Temp Temp 82 °F T1 --- °F T2 --- °F Clear Menu Save </pre>
	<pre> Diff Temp Temp 82 °F T1 84 °F T2 82 °F T1-T2 2 °F Clear Menu Save </pre>
	<p>Note that a negative differential value will be displayed if T1<T2.</p>



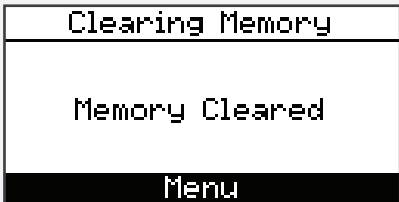



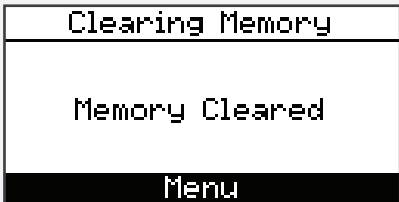

NOTE: The Differential Temperature feature requires the use of the optional thermocouple (P/N: 0104-1797) or the optional probe assembly (P/N: 0019-7111).



















3.6 Memory Options Menu







Memory Options	Function				
	<p>Access the Memory Directory. This directory contains a numbered list of saved tests (<i>starting at "1"</i>) to a maximum of 100 test records. "NO DATA" is displayed if no tests were saved since the last time that memory was cleared. A "Memory Full" message is displayed if you try to save test 101.</p> <table border="1"> <tr> <td data-bbox="693 549 1090 750">  </td> <td data-bbox="1118 549 1517 750">  </td> </tr> </table> <p>To view saved data, use the UP (▲) and DOWN (▼) arrow buttons to highlight the desired test from the list. Press the ENTER button to display the saved data.</p> <table border="1"> <tr> <td data-bbox="693 916 1090 1116">  </td> <td data-bbox="1118 916 1517 1116">  </td> </tr> </table>				
					
					
	<p>Prompts user before clearing all saved tests from memory. Selecting NO returns the display to the Memory Options menu.</p> <table border="1"> <tr> <td data-bbox="693 1254 1090 1455">  </td> <td data-bbox="1118 1254 1517 1455">  </td> </tr> </table> <p>Selecting YES clears the memory and displays the Memory Cleared message.</p> <table border="1"> <tr> <td data-bbox="693 1558 1090 1759">  </td> <td data-bbox="1118 1558 1517 1759">  </td> </tr> </table>				
					
					

3.7 Setup Menu

Setup Menu	Function
	<p>Access Temperature Units ($^{\circ}C$ or $^{\circ}F$) to be used by the instrument and for display and printing purposes.</p> <p>Use the UP (\blacktriangle) and DOWN (\blacktriangledown) arrows buttons to highlight the desired choice. Press the ENTER button to use the selected temperature unit. Press ESC to quit without saving.</p> <div style="display: flex; justify-content: space-around;">   </div>
	<p>The Clock option provides access to the clock setup function to set date and time.</p> <p>Use the LEFT (\blacktriangleleft) and RIGHT (\blacktriangleright) arrow buttons to select the desired field to edit. Then use the UP (\blacktriangle) and DOWN (\blacktriangledown) arrow buttons to change the values of the selected field. Press ENTER to save new date and time. Press ESC to quit without saving.</p> <hr/> <p> NOTE: See DATE FORMAT option in SETUP MENU to select either MM/DD/YY format or DD/MM/YY format.</p> <hr/> <div style="text-align: center;">  </div> <hr/> <p> NOTE: The presence of AM or PM after the time on the Set Clock display indicates 12-hour time format and MM/DD/YY date format. Similarly, the absence of AM or PM indicates 24-hour time format and the date is in DD/MM/YY format.</p> <hr/>





Setup Menu	Function						
	<p>The zoom options selects the size of the characters on the Run/Hold screen. Three options are Standard, 2x, and 3x. Options are shown below with their respective Run/Hold screens. Use the UP (▲) and DOWN (▼) arrow buttons to scroll through display items that don't fit on the screen.</p> <table border="0"> <tr> <td data-bbox="690 454 1093 685"> <p>Zoom Level</p> </td> <td data-bbox="1115 454 1518 685"> <p>Sample Run / Hold Screen</p> </td> </tr> <tr> <td data-bbox="690 720 1093 929"> </td> <td data-bbox="1115 720 1518 929"> </td> </tr> <tr> <td data-bbox="690 963 1093 1172"> </td> <td data-bbox="1115 963 1518 1172"> </td> </tr> </table>	<p>Zoom Level</p>	<p>Sample Run / Hold Screen</p>				
<p>Zoom Level</p>	<p>Sample Run / Hold Screen</p>						



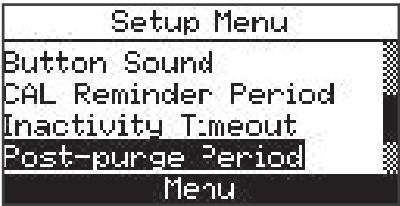
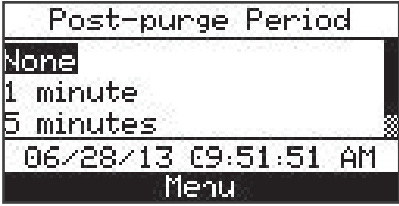
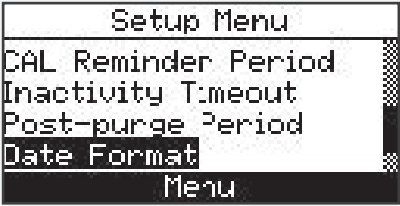
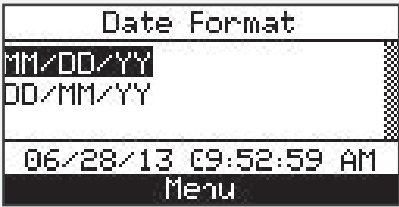
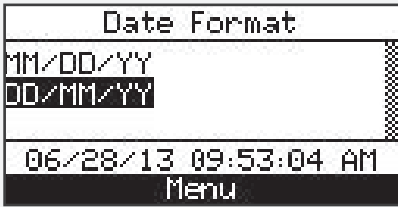

Setup Menu	Function						
	<p>Provides an interface for entering user identification information used on printouts. Generally, the Username fields contain the HVAC company and related information.</p> <hr/> <p>i NOTE: This data can be entered using the Fyrite® User Software (FUS).</p> <hr/> <p>Use the UP (▲) and DOWN (▼) arrow buttons to choose a row and press ENTER to begin editing the selected row. Then use the UP (▲) and DOWN (▼) arrow buttons to select the desired letter, number, or special character for the current text position.</p> <p>/ ! @ # \$ % & * - ' <SPACE> a-z A-Z 0-9</p> <p>Use the LEFT (◀) and RIGHT (▶) arrow buttons to move the cursor horizontally on the selected row and repeat the character selection process for each text position. When finished, press ENTER to save the row's changes. Repeat for all 3 lines. Then select EDIT COMPLETE and press ENTER to finish.</p> <table border="0" data-bbox="695 965 1520 1606"> <tr> <td data-bbox="695 965 1092 1192"> <p>Select Mode</p>  </td> <td data-bbox="1122 965 1520 1192"> <p>Editing Mode</p>  </td> </tr> <tr> <td data-bbox="695 1194 1092 1397">  </td> <td data-bbox="1122 1194 1520 1397">  </td> </tr> <tr> <td data-bbox="695 1399 1092 1606">  </td> <td data-bbox="1122 1399 1520 1606">  </td> </tr> </table>	<p>Select Mode</p> 	<p>Editing Mode</p> 				
<p>Select Mode</p> 	<p>Editing Mode</p> 						
							
							

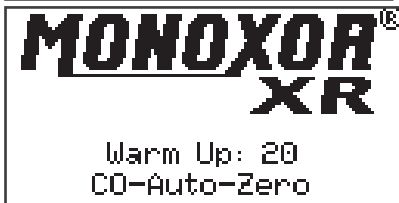
Setup Menu	Function
	<p>The Language Selection option allows the user to choose a language for all menus. Use the UP (▲) and DOWN (▼) arrow buttons to scroll through language options. Use ENTER to enable the selected language.</p>  <p>Three languages are available: English, French, and Spanish.</p>
	<p>The button sound option is used to select whether or not the analyzer makes an audible sound every time a key is pressed. Select OFF to disable this feedback, or ON to enable this feedback. Then press ENTER to select, or ESC to discard changes.</p>  
	<p>The CAL Reminder Period option sets a time period after which the analyzer displays a calibration reminder message during warm-up. Calibration reminders can be set to occur never, 6, 8, 10, 12, or 15 months after the last calibration. Select NEVER (<i>the default setting</i>) to disable this feature. When the preset period is exceeded the instrument will display the reminder, and how long since the sensor was last calibrated. If a calibration reminder is displayed, the operator can press the RUN/HOLD key to move to the RUN/HOLD Screen for normal operation. Regular calibration periods of 6 months to 1 year are recommended.</p> <p>Set the calibration reminder period as follows:</p> <ol style="list-style-type: none"> 1. Use the UP (▲) and DOWN (▼) arrow buttons to select the desired time period. 2. Press ENTER to save the selection or ESC to revert to the previous setting.

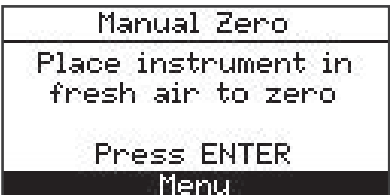
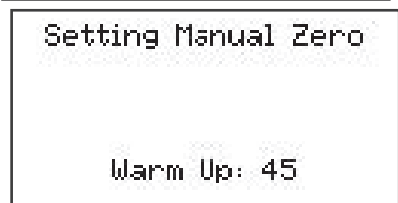



Setup Menu	Function
	<p> NOTE: The date and time settings must be correct to get accurate calibration reminders.</p> <div style="display: flex; justify-content: space-around;"> <div style="border: 1px solid black; padding: 5px; width: 45%;"> <p>CAL Reminder Period</p> <p>Never</p> <p>6 months</p> <p>8 months</p> <p>10 months</p> <p style="text-align: center;">Menu</p> </div> <div style="border: 1px solid black; padding: 5px; width: 45%;"> <p>CAL Reminder Period</p> <p>Never</p> <p>6 months</p> <p>8 months</p> <p>10 months</p> <p style="text-align: center;">Menu</p> </div> </div> <div style="display: flex; justify-content: space-around;"> <div style="border: 1px solid black; padding: 5px; width: 45%;"> <p>CAL Reminder Period</p> <p>Never</p> <p>6 months</p> <p>8 months</p> <p>10 months</p> <p style="text-align: center;">Menu</p> </div> <div style="border: 1px solid black; padding: 5px; width: 45%;"> <p>CAL Reminder Period</p> <p>Never</p> <p>6 months</p> <p>8 months</p> <p>10 months</p> <p style="text-align: center;">Menu</p> </div> </div> <div style="display: flex; justify-content: space-around;"> <div style="border: 1px solid black; padding: 5px; width: 45%;"> <p>CAL Reminder Period</p> <p>6 months</p> <p>8 months</p> <p>10 months</p> <p>12 months</p> <p style="text-align: center;">Menu</p> </div> <div style="border: 1px solid black; padding: 5px; width: 45%;"> <p>CAL Reminder Period</p> <p>8 months</p> <p>10 months</p> <p>12 months</p> <p>15 months</p> <p style="text-align: center;">Menu</p> </div> </div>
<div style="border: 1px solid black; padding: 5px; width: 100%;"> <p>Setup Menu</p> <p>Language Selection</p> <p>Button Sound</p> <p>CAL Reminder Period</p> <p>Inactivity Timeout</p> <p style="text-align: center;">Menu</p> </div>	<p>Provides a list from which to select an inactivity (<i>key press</i>) timeout for automatic shutdown. If no key presses occur for the time specified, the Monoxor® XR initiates an automatic shutdown.</p> <p>Use the UP (▲) and DOWN (▼) arrow buttons to scroll through Inactivity Timeout options (<i>None [default], 20, 30, or 60 minutes</i>). Use the ENTER key to enable the selected timeout.</p> <div style="border: 1px solid black; padding: 5px; width: 100%;"> <p>Inactivity Timeout</p> <p>None</p> <p>20 minutes</p> <p>30 minutes</p> <p>06/28/13 09:50:22 AM</p> <p style="text-align: center;">Menu</p> </div>

Setup Menu	Function
	<p>Provides a list from which the user may chose a minimum purge duration time (minimum length of time that the pump continues to run) after shutdown is initiated. Use a longer Post-Purge Period if the Monoxor® XR has been exposed to high concentrations of CO gas. Use ENTER to enable the selected Post-Purge Period. "PURGING SENSORS" is displayed on the shutdown screen if a Post-Purge Period is enabled.</p> <p>Use the UP (▲) and DOWN (▼) arrow buttons to scroll through Post-purge Period options.</p> 
	<p>The Date Format option provides a list from which the user may select the desired date format used by the instrument.</p> <ul style="list-style-type: none"> • MM/DD/YY (w/ 12-hour time format) • DD/MM/YY (w/ 24-hour time format) <p>Use the UP (▲) and DOWN (▼) arrow buttons to highlight the desired date format. Press ENTER to save new date format. Press ESC to quit without saving.</p>  







Setup Menu	Function
	<p>Provides a list from which the user may select the desired method for zeroing the CO sensor.</p> <ul style="list-style-type: none"> • Auto-Zero happens automatically at warm-up. • Manual zero is used to initiate the zeroing process whenever desired. <p>Use the UP (▲) and DOWN (▼) arrow buttons to highlight the desired zeroing method. Press ENTER to save. Press ESC to quit without saving.</p> <div style="display: flex; justify-content: space-around;"> <div data-bbox="690 530 1088 1159" style="width: 45%;"> <p>CO Auto Zero</p>    </div> <div data-bbox="1110 530 1508 1159" style="width: 45%;"> <p>CO Manual Zero</p>    </div> </div> <p>By default, the Monoxor® XR automatically zeroes all sensors on ambient air when the instrument is turned on. The Monoxor® XR can be set to perform and store a manual zero for the CO sensor. The instrument uses the stored value to indicate background CO values after warm-up instead of performing an auto-zero on the background gas.</p>

Setup Menu	Function
	<p>The CO Alarm Limit option is used to enable and disable the alarm limit feature.</p> <div style="display: flex; justify-content: space-around;">   </div> <p>If enabled (ON), an additional screen is displayed where you set the CO alarm setpoint. The alarm limit is selectable from 0 to 80,000 ppm. Use the Up and Down arrow buttons to scroll to the desired alarm limit value then press ENTER.</p> <div style="display: flex; justify-content: space-around;">   </div> <p>Note that scrolling wraps forward and backwards, so pressing the down arrow at 0 ppm wraps backwards to 80,000. Similarly, pressing up arrow at 80,000 ppm wraps forward to 0 ppm. When the CO Alarm Limit option is enabled, the built-in buzzer will sound if CO readings exceed the CO alarm limit that you defined.</p>

3.8 Calibration Menu

Calibration Menu	Function
	<p>Calibration is performed by applying known values and accessing the password-protected menu items. When the Calibration Menu is selected, the user must enter a 4-digit numeric security code in order to proceed to the calibration options. The default password is 1111. Use the UP (▲) and DOWN (▼) arrow buttons to scroll through numerals 0-9 until the desired numeral is reached. Press ENTER to advance to the next position of the password. Press ENTER after all four digits are set. Press ESC to return to the SETUP MENU.</p>  <hr/> <p> NOTE: The calibration password can be changed through the Fyrite® User Software (FUS).</p> <hr/>  <p>Refer to Chapter 5 for additional screens and calibration procedures.</p>

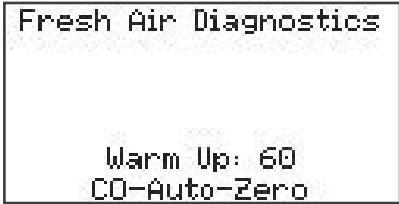
3.9 Diagnostics Menu

Diagnostics Menu	Function
	<p>Displays time metrics for pump use and total operation time.</p> 
	<p>Displays information about the measurement sensors of the instrument.</p> 
	<p>Displays fresh air diagnostics similar to the display at warm-up. After the warm-up countdown, any detected errors are displayed. Otherwise, a "Success" message is displayed.</p> <div style="display: flex; justify-content: space-around;"> <div data-bbox="692 1192 1090 1394">  </div> <div data-bbox="1117 1192 1515 1394">  </div> </div> <div style="margin-top: 20px;">  </div>

3.10 Status Menu

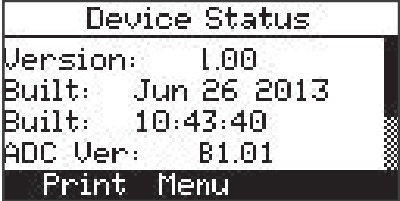
Status Menu	Function
	<p>This is the device status screen which displays information about the device. Some of the information displayed on this screen includes serial number, firmware version, model number, etc.</p> 

4. Operation

4.1	Overview.....	40
4.2	Taking a Gas Sample.....	41
4.3	The RUN and Hold Screens.....	42
4.4	CO Trending Graph.....	43
4.6	Ending a Test.....	44
4.7	Taking Differential Temperature Measurements.....	44
4.8	Timed Ambient CO Testing.....	45
4.9	Printing Using the Optional IrDA Printer.....	46
4.9	Turning Off the Analyzer.....	48
4.10	PC Interface and Fyrite® User Software.....	49

4.1 Overview

To operate the Monoxor® XR, you simply:

- Turn the analyzer ON
- Wait for the unit to warm up
- Take a gas sample

Before beginning your test, verify the following:

- menu items are properly configured
- the disposable filter is clean
- the probe is attached to the instrument
- the power is ON and sufficient (*one of the following*):
 - - four new batteries (*AA alkaline*)
 - - four new batteries (*AA lithium*)
 - - four fully-charged AA rechargeable batteries
- the warm-up process has completed in fresh air without interruption or errors

4.2 Taking a Gas Sample

Menus and the items contained within them are described in a top-down fashion, starting from the startup screens and working sequentially through the menus and menu items.



IMPORTANT: If the CO channel is set up for Auto Zero (refer to Section “3.7 Setup Menu”), ensure that the analyzer will be sampling fresh air (containing no CO) when turned ON.

Turn ON the analyzer by pressing the PWR button. Observe that when power is first applied, the software revision level is first displayed followed by a screen that counts down the warm-up period. The warm-up period is 60 seconds.

Fig. 4-1: Warm-Up Screens

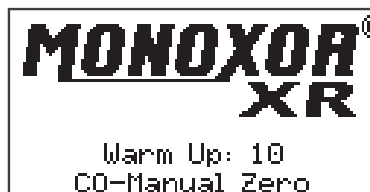

Following warm-up (and an optional error screen), the Main Menu screen appears. If the probe is being used, insert the probe tip into the area to be sampled. Press the Run/Hold button once to display the HOLD screen (last values), and a second time to display the RUN screen (dynamic display of current CO level in ppm, temperature, and min/max CO values).

Fig. 4-2: Warm-Up Screens

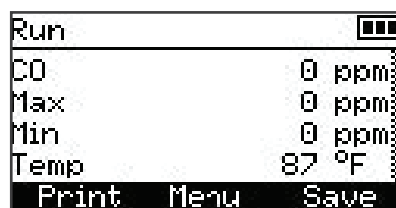
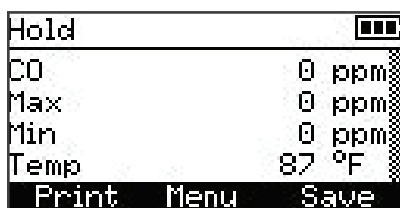

NOTE: If a sensor error was detected during warm-up, the CO Sensor Error Screen will be displayed.

4.4 The RUN and Hold Screens

Menus and the items contained within them are described in a top-down fashion, starting from the startup screens and working sequentially through the menus and menu items.

Fig. 4-3: Sample RUN and Hold Screens

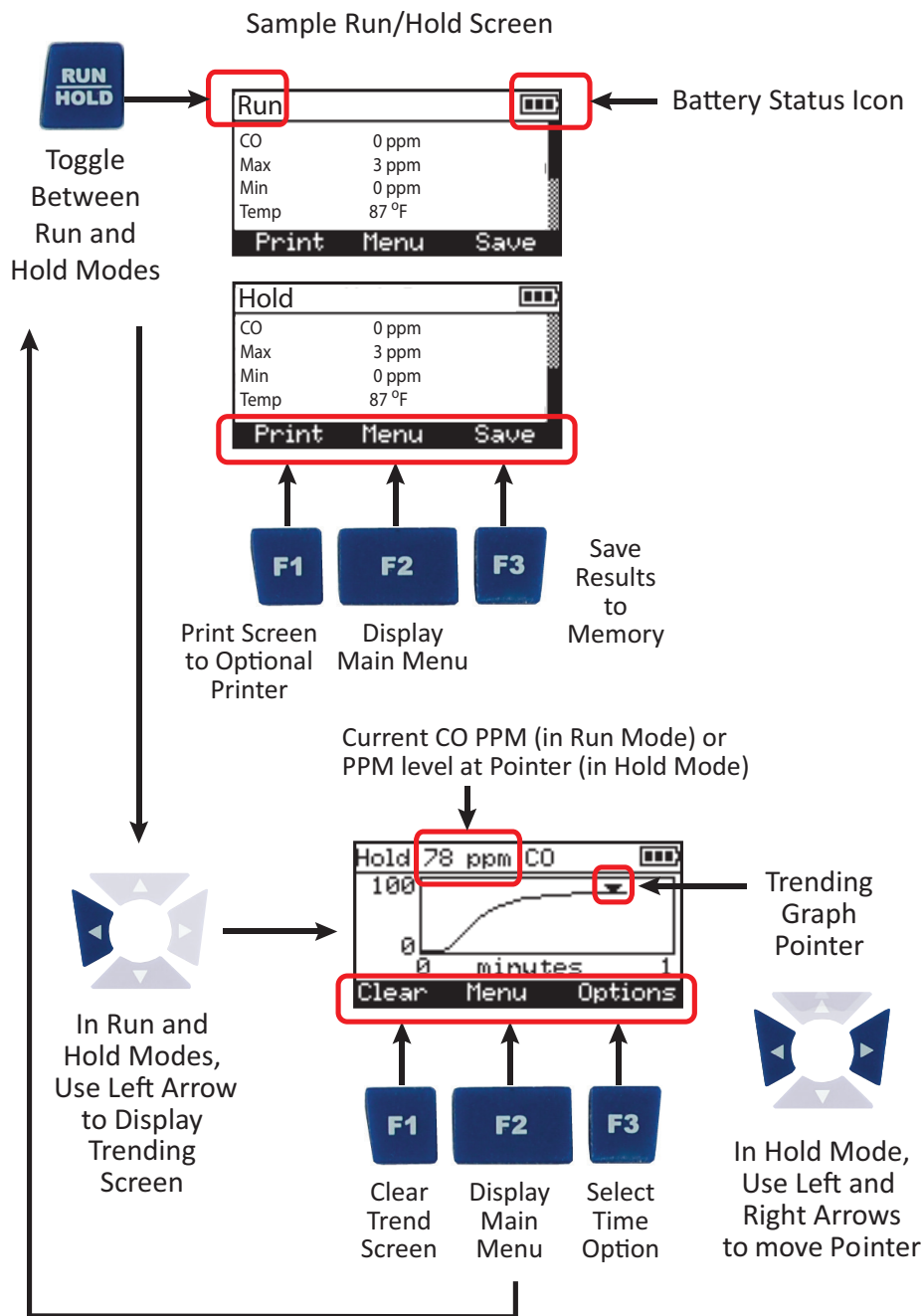



NOTE: Use the left or right arrow buttons from the Run or Hold screen to view the CO trending graph.

4.5 CO Trending Graph

A trending screen is accessible from the RUN or HOLD screen by using the right of left arrow keys. The CO Trending Screen shows dynamic CO levels graphed over a programmable time period. User-selectable time periods are:

- 30 seconds
- 1 minute
- 3 minutes
- 5 minutes
- 15 minutes

Figure 4-4: CO Trending Screens

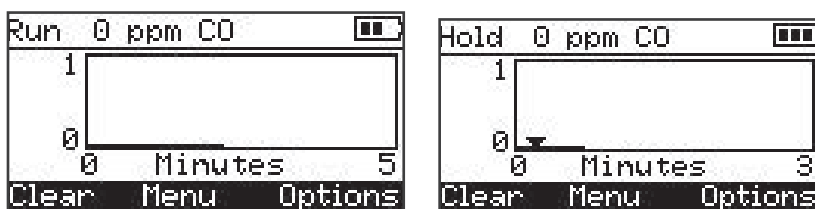

The graph continues to sample CO gas while in RUN mode, showing the current PPM reading above the dynamic graph. Press the RUN/HOLD button (*HOLD mode*) to freeze the current graphical snap-shot. In HOLD mode, a pointer appears on the graph. This pointer can be moved along the graph using the left and right arrow keys. As you move the pointer left and right, the value of the CO at that point in the sampling is displayed at the top of the screen.

Figure 4-5: CO Trending Screens Hold Mode

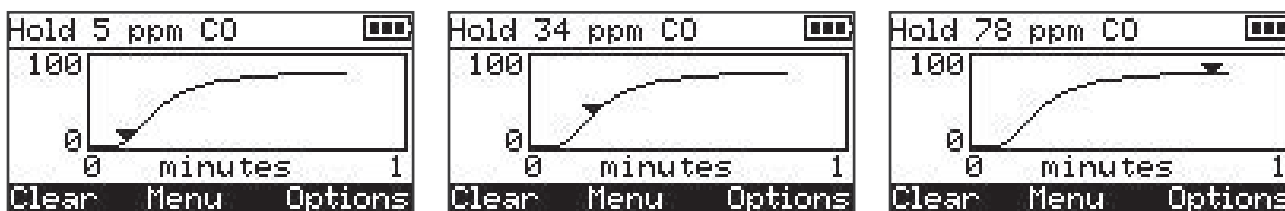

4.6 Ending a Test



WARNING: Burn Hazard. Do not touch the probe after removing it from a flue. Allow the probe to cool before handling (*about 5 minutes*).

After taking a gas sample, remove the probe and take the analyzer to an area containing fresh air. Allow the pump to run until the CO reading drops to near zero.

4.7 Differential Temperature Measurement

In certain combustion applications, it may be desirable to have a differential temperature measurement. Use the Diff Temp menu and either the optional probe assembly with thermocouple (P/N 0019-7111), or one of the optional K-Type thermocouples (P/N 0104-1798 or P/N 0104-1797) to accomplish this task.

The Monoxor® XR calculates the differential temperature based on two sampled temperatures (T1 and T2) which it reads from the optional probe assembly's thermocouple (which is connected to the T-STACK connector of the instrument). After you take the two sample readings, the differential value (T1-T2) is calculated, optionally saved in memory, displayed on the main run screen, and is shown on printouts. Use the following procedure to perform a differential temperature measurement.

Example Procedure for Taking Differential Temperature Measurements

1. Attach the thermocouple plug of the optional probe assembly to the T-STACK connector on the bottom of the Monoxor® XR.

From the Main Menu, select the Diff Temp option. When this option is first selected, the current temperature (*Temp*) is displayed. Values for T1 and T2 will show no readings until they are saved by the operator, after which a differential value (T1-T2) will also be displayed.

Figure 4-6: Diff Temp Menu

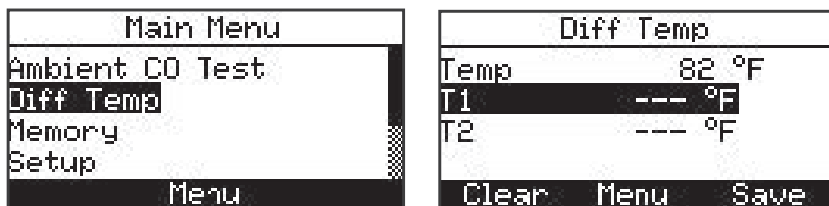

2. With T1 highlighted, position the probe at desired location #1.
3. After a T1 temperature reading is displayed and stabilizes, press the F3 (*SAVE*) button to store the current T1 temperature reading. The T2 temperature reading is highlighted.
4. Move the probe to desired location #2.

5. After a T2 temperature reading is displayed and stabilizes, press the F3 (SAVE) button to store the current T2 temperature reading.
6. The temperature differential temperature (T1-T2) will be displayed.

Figure 4-7: Diff Temp Menu

Diff Temp	
Temp	82 °F
T1	--- °F
T2	--- °F
Clear	Menu Save

Diff Temp	
Temp	82 °F
T1	84 °F
T2	82 °F
T1-T2	2 °F
Clear	Menu Save

7. At this point, you may press SAVE again to save the differential temperature value to memory so that it can be retrieved and/or printed later.
8. Carefully remove the probe assembly and allow it to cool.

i **NOTE:** A negative differential value will be displayed if T1<T2.

4.8 Timed Ambient CO Testing

This procedure takes approximately 15 minutes to complete and provides a minute-by-minute snapshot of CO readings, as well as a “Max CO” value that represents the highest CO reading measured during the entire 15-minute test. Results can be saved to memory and/or printed.

Example Procedure for Taking Ambient CO Measurements

1. Attach optional probe if required.
2. Turn on the Monoxor® XR in a fresh air environment and wait for initialization to complete.
3. Verify successful initialization (*no errors*).
4. Check battery status (*see section 2.3*). If battery life is questionable, replace the batteries, as the Ambient CO test takes approximately 15 minutes to complete.
5. Move instrument to target location to be tested.
6. Press F2 to display the Main Menu.
7. Use the down arrow to highlight Ambient CO Test and press the ENTER button.
8. Follow the on-screen instructions to initiate the test.
9. Refer to section 3.4 for details on navigating the ambient CO test screens, viewing results, saving results to memory, and printing results.

4.9 Printing Using the Optional IrDA Printer

The instrument has the ability to store, recall (*to the display*), and print sets of time- and date-coded test records. The time and date are set through software menu selections.

- Displaying stored records is done through the MEMORY DIRECTORY MENU.
- Press F1 to print displayed test records.

Example Printing Procedure Using Optional IrDA Printer

1. Monoxor® XR should be turned on and displaying a screen with an F1 Print option.
2. Check for a sufficient supply of paper and batteries in the IrDA printer.
3. Turn on the printer.
4. Position the printer within 8 to 16 inches (*20 to 41 cm*) from the instrument and at no greater than a 60-degree angle.

Figure 4-8: Printouts

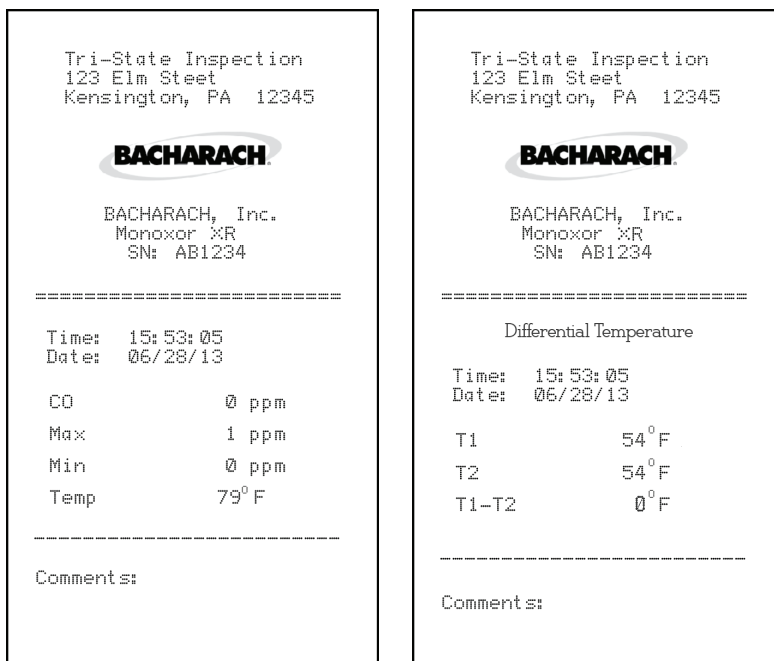
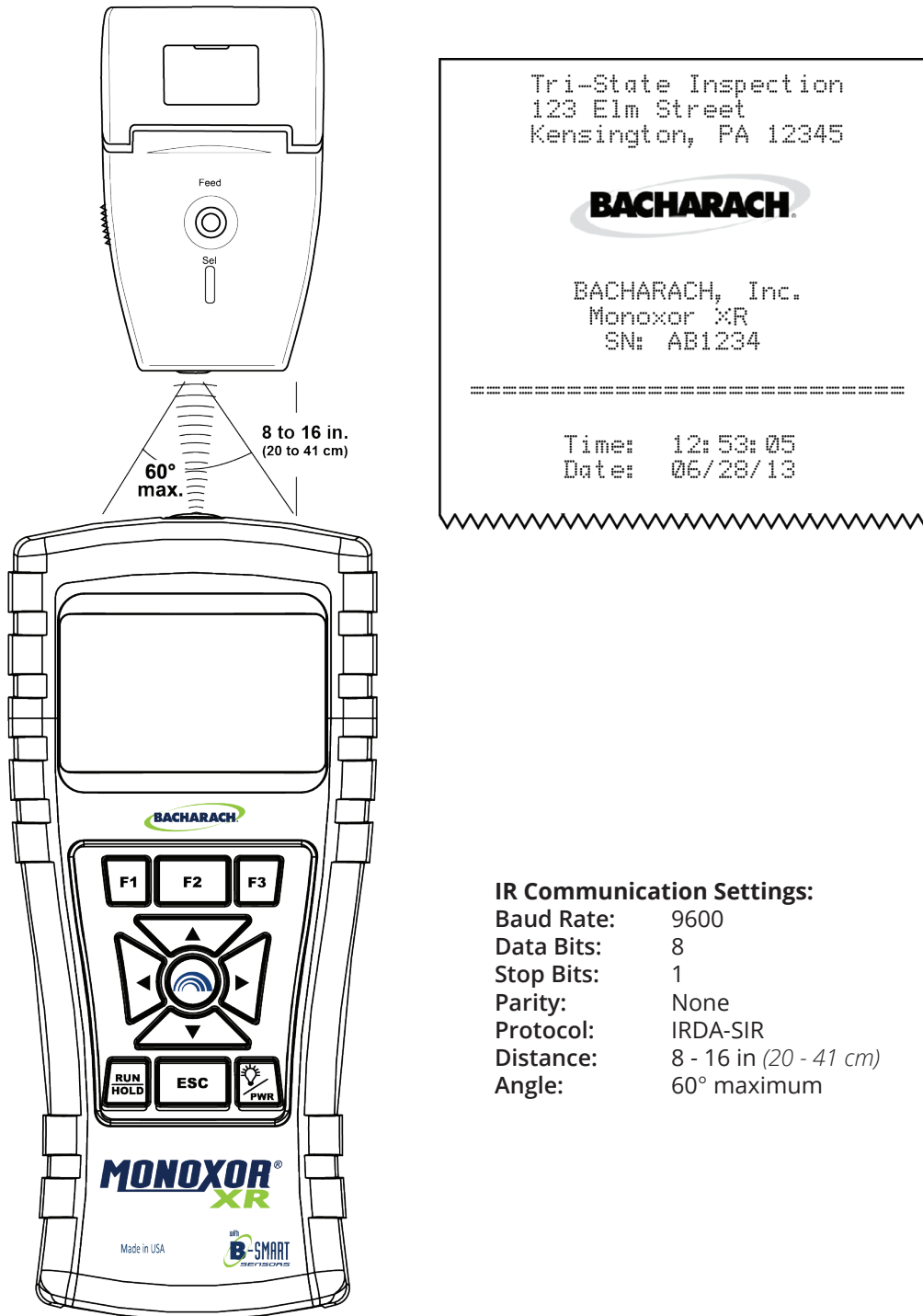

Figure 4-9: Using Optional IrDA Printer



The Monoxor® XR provides three lines of 20 characters for user information. This information will appear with test records when they are printed. User name and optional information are entered via software menu selections in the SETUP MENU or via the Fyrite® User Software (FUS).

In addition to the three lines of text, the Monoxor® XR can be setup to include a custom logo on printouts. Logos are loaded into the instrument using the Fyrite® User Software (FUS). Logo size is limited to 192 × 384 pixels (*height × width*) and must be in one of the following formats: .BMP, .JPG, .PNG, or .TIFF. For best results, the logo should be saved in black and white.

Figure 4-10: Custom Logo Printout Example

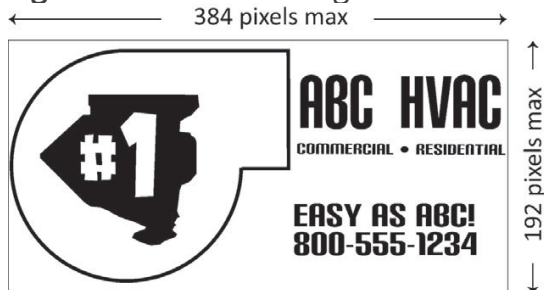

4.10 Turning Off the Analyzer

Turn OFF the analyzer by pressing the power button and holding for approximately 2 seconds. The analyzer will count down from 5 seconds before turning OFF. Pressing ENTER, however, will abort the count down and keep the analyzer ON.

Figure 4-11: Shut-down Screen



4.11 PC Interface and Fyrite® User Software

A PC with Fyrite® User Software (FUS) installed can set, edit, and transfer the following:

- Instrument time and date
- Calibration password
- Time meters
- B-Smart® code
- User name
- Instrument settings
- Customer logo
- Firmware updates
- Language

5. Care & Maintenance

5.1	Serviceability	50
5.2	Cleaning the Probe	51
	5.2.1 <i>Equipment Required</i>	51
	5.2.2 <i>Procedure</i>	52
5.3	Filter Replacement	53
5.4	CO Sensor Replacement	54
	5.4.1 <i>Accessing the CO Sensor</i>	54
	5.4.2 <i>Material Required (As Needed)</i>	54
	5.4.3 <i>CO Sensor Replacement Procedure</i>	55
	5.4.4 <i>B-Smart® CO Sensor Replacement</i>	56
5.5	Temperature Calibration	57
	5.5.1 <i>Materials Required</i>	57
	5.5.2 <i>Temperature Calibration Procedure</i>	57
5.6	CO Sensor Calibration	59
	5.6.1 <i>Materials Required</i>	59
	5.6.2 <i>CO Manual Zero Procedure</i>	59
	5.6.3 <i>CO Sensor Span Procedure</i>	60
5.7	T-Ref Sensor Calibration	61

5.1 Serviceability

The instrument operator is able to easily replace the following components without the use of tools:

- probe assembly
- probe filters
- batteries
- B-Smart® CO sensor
- printer paper.

Additionally, a technician, with the use of factory-provided instructions, can:

- perform basic diagnostics
- confirm proper operation

before putting the unit back into service. Field calibration is also possible with the proper equipment. Refer to the calibration section for more information.

5.2 Cleaning the Probe

The probe tube and gas sample hose will become dirty under normal use.



NOTE: The filter element should prevent soot from reaching the analyzer's internal components. If the probe is not kept clean, it could become clogged and restrict the flow of gas into the analyzer, resulting in incorrect test readings.



NOTE: An analyzer that tests natural gas furnaces normally requires less frequent cleaning than an analyzer used for testing coal- or oil-fired furnaces.

5.2.1 Equipment Required

- Alcohol
- Aerosol Can of Automotive Carburetor Cleaner
- Clean Rag
- Source of Compressed Air (*optional*)



CAUTION: Do not use flammable or combustible substances (*like carburetor fluid used for cleaning the probe*) near an open flame.

5.2.2 Procedure

1. Remove gas sample hose from the disposable filter assembly.



CAUTION: Carburetor cleaner damages plastic components. Take precautions not to spray cleaner onto the probe handle or analyzer.

2. Insert the plastic spray tube of the carburetor cleaner into the gas sample hose, and then liberally spray carburetor cleaner through the hose and out the probe tube.
3. After spraying, remove all the residual cleaner by repeatedly flushing the gas hose and probe tube with alcohol.
4. Wipe off the surfaces of the probe and tubing with a clean cloth.
5. Allow the parts to dry completely. If available, blow compressed air through the probe to expedite the drying process.
6. Reconnect gas sample hose to the disposable filter assembly.

5.3 Filter Replacement

Figure 5-1: Filter Replacement

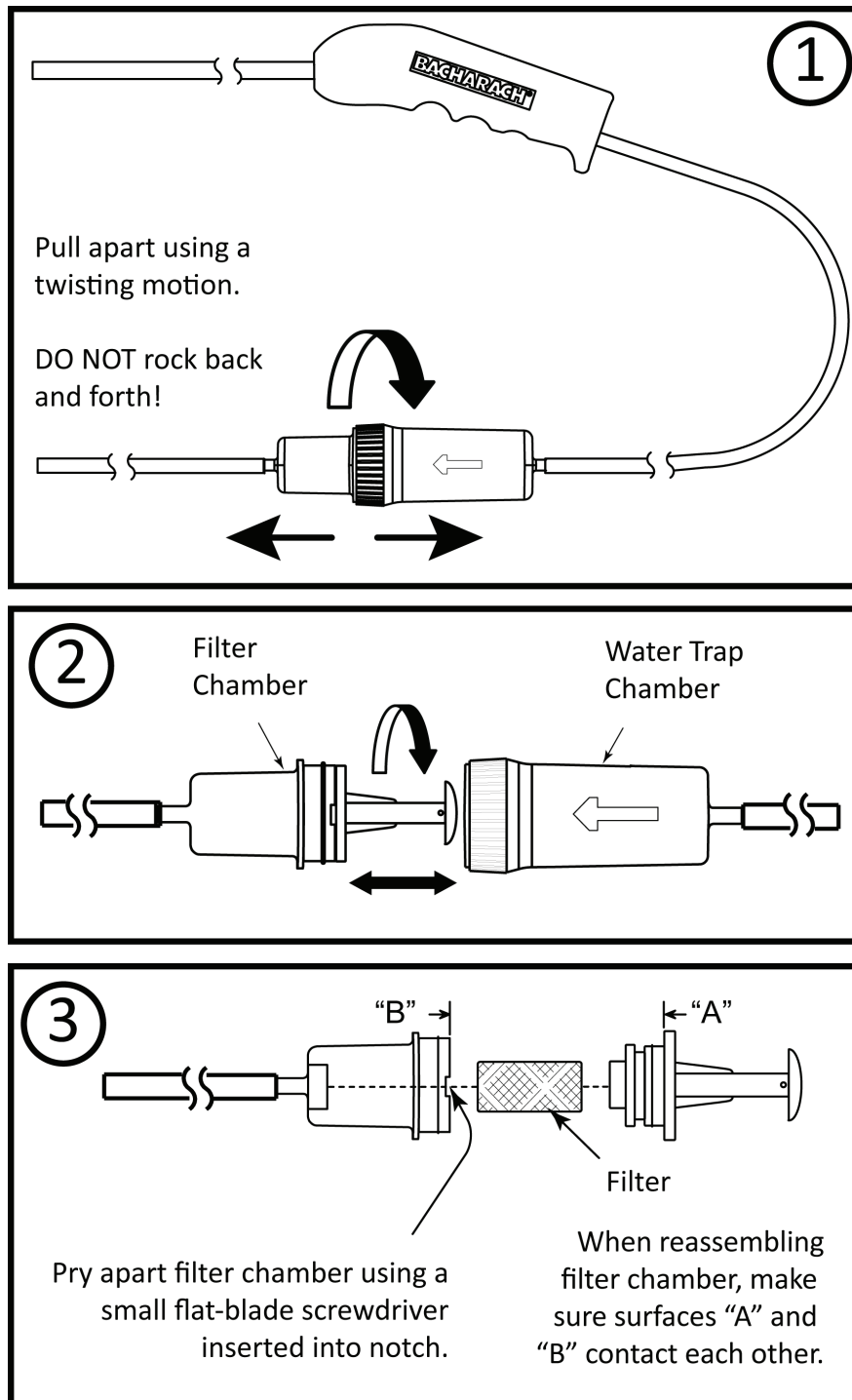

5.4 CO Sensor Replacement

5.4.1 Accessing the CO Sensor

Figure 5-2: Accessing the CO Sensor

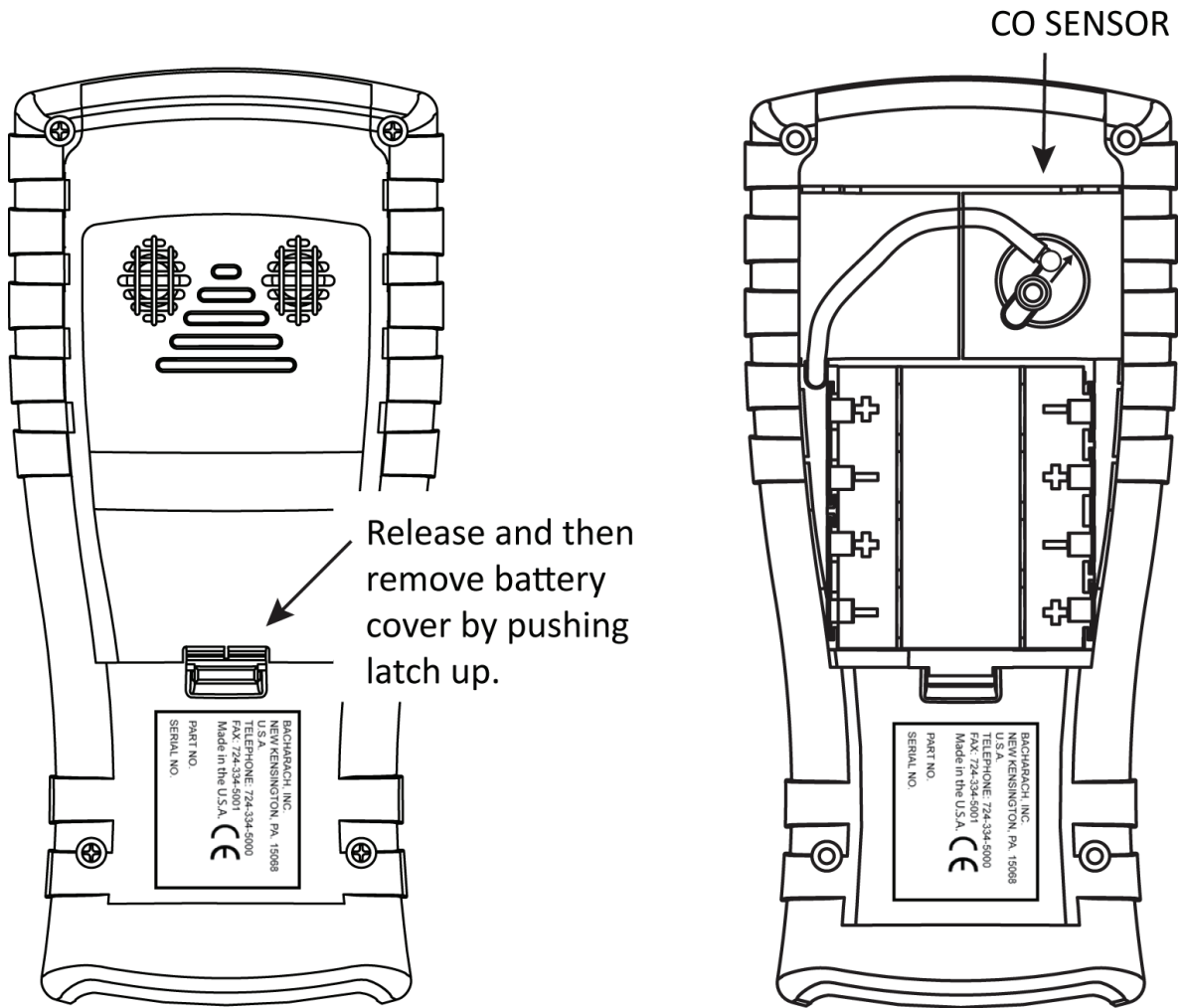

5.4.1 CO Sensor Replacement Procedure

Follow the procedure below for CO sensor replacement.

1. Remove battery door and the connector tubing from the CO sensor.
2. Remove CO cap by twisting counter clockwise.
3. Gently pull CO sensor out of its socket.
4. Properly dispose of the old CO sensor.
5. Plug new CO sensor into its socket.
6. Install the CO cap by aligning it toward the “open” position (12 o’clock) as shown in the diagram below, then twisting the cap clockwise approximately 40° to the “closed” position (2 o’clock).
7. Reattach tubing.
8. Calibrate the CO sensor using either the standard calibration procedure or the B-Smart® procedure.

Figure 5-3: CO Sensor Replacement Diagram

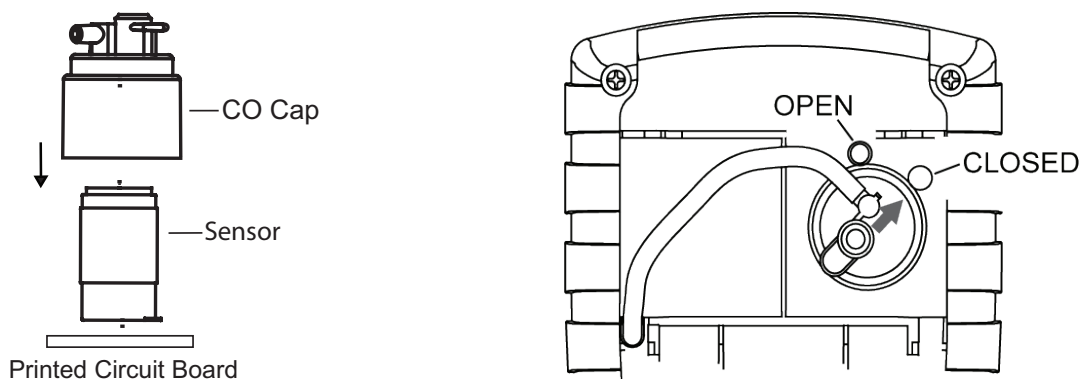

5.4.2 B-Smart® CO Sensor Replacement

1. Enter the CALIBRATION MENU. Note that this requires password validation (*see section 3.8*).
2. Use the UP (▲) and DOWN (▼) arrow buttons to select B-Smart®. Press ENTER to display the B-Smart® code screen.
3. Use the UP (▲) and DOWN (▼) arrow buttons to enter the 10-digit alphanumeric code supplied with the pre-calibrated B-Smart® sensor. Use the LEFT (◀) and RIGHT (▶) arrow buttons to move the cursor across the screen. Press ENTER.

Figure 5-4: CO Sensor Replacement Screens

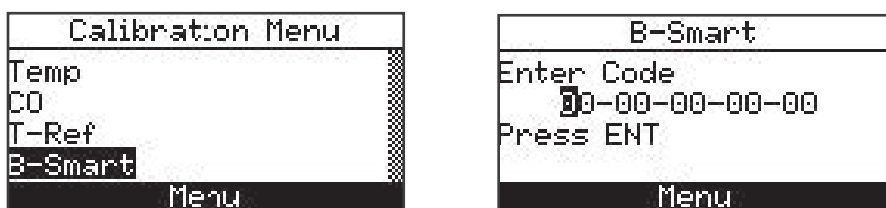

NOTE: If the correct code was entered, the analyzer accepts it and returns to the CALIBRATION MENU. If an incorrect code was entered, the screen will display “Invalid Code.” Check to make sure the correct code has been entered. If the problem persists, contact your nearest Bacharach Service Provider.



NOTE: B-Smart® codes can be entered through the Fyrite® User Software (FUS)



NOTE: Installing a B-Smart® sensor forces the instrument to perform a zero function (*either manual or automatic*)



NOTE: Bacharach offers a convenient Exchange Program (*where available*) that allows the customer to regularly receive pre-calibrated replacement sensors that include a code that can be entered into the analyzer for a quick convenient setup. Contact Bacharach customer service for more details about this program.

5.5 Temperature Calibration

This procedure first zeroes and then spans the temperature channel to known temperature values. The use of an electronic thermocouple simulator is the preferred method of producing the desired calibration temperatures. Alternatively, ice and boiling water baths can be used.

5.5.1 Materials Required

- Thermocouple simulator (K-type)
 Range: 0 to 600° F (-18 to 316° F)
 Accuracy: ± 0.5° F (± 0.3° C)
- (Alternatively) ice water, boiling water, thermometer

5.5.2 Temperature Calibration Procedure

1. Plug the simulator into the TEMP connector located at the bottom of the analyzer.

Alternatively: Plug the probe's thermocouple into the TEMP connector located at the bottom of the analyzer if using optional probe with thermocouple accessory (P/N 0024-7111).



IMPORTANT: DO NOT attach the probe's gas hose to the analyzer's GAS port; otherwise water will be drawn into the analyzer.

2. If not already done, turn ON the analyzer and display the CALIBRATION Menu. Note that this requires password validation (*see section 3.8*).
3. Use the UP (▲) and DOWN (▼) arrow buttons to highlight Temperature, and then press ENTER to display the CALIBRATE TS-ZERO screen.

Figure 5-5: Calibration Menu & TS-Zero Calibration Screens



“Measured” is the current temperature reading. “Applied” is a known temperature that will be applied for calibration purposes.

4. Set thermocouple simulator to 32° F (0° C), and then use the UP (▲) and DOWN (▼), LEFT (◀) and RIGHT (▶) arrow buttons to enter an Applied value that exactly equals the setting of the simulator.

Alternatively: Submerge probe tip into an ice-water bath with a thermometer, wait several minutes, and then use the UP (▲) and DOWN (▼) arrow buttons to enter an Applied value that exactly equals the thermometer reading.



NOTE: The calibration range is from 32 to 41° F (0 to 5° C). An attempt to calibrate outside this range will cause the message “Applied Value High” (or Low) to appear at the bottom of the screen.

5. Wait until the Measured reading stabilizes, and then press ENTER to calibrate the TS-Zero Measured value to that of the Applied value, after which the message “Good Calibration” should briefly appear followed by the CALIBRATE TS-SPAN screen.
6. Set thermocouple simulator to 572° F (300° C), and then use the UP (▲) and DOWN (▼), LEFT (◀) and RIGHT (▶) arrow buttons to enter an Applied value that exactly equals the setting of the simulator.

Figure 5-6: Calibration T-Span Screen

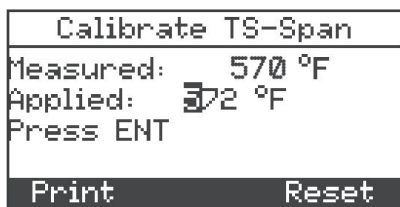

Alternatively: Submerge probe tip into a container of boiling water with a thermometer, wait several minutes, and then use the arrow buttons to enter an Applied value that exactly equals the thermometer reading.



NOTE: The calibration range is from 175 to 625° F (80 to 329° C). An attempt to calibrate outside this range will cause the message “Applied Value High” (or Low) to appear at the bottom of the screen.

7. Wait until the Measured reading stabilizes, and then press ENTER to calibrate the TS-Span Measured value to that of the “Applied” value, after which the message “Good Calibration” should briefly appear followed by the CALIBRATION menu being re-displayed.

5.6 CO Sensor Calibration

5.6.1 Materials Required

- Calibration kit, P/N 0024-7059
- Gas cylinder: 500 ppm CO in air, P/N 0024-0492

5.6.2 CO Manual Zero Procedure

The CO zeroing process is done automatically during warm-up or manually using the manual zero feature. To perform a manual zero, follow the steps below. If your instrument is configured for CO auto zero, then skip this CO manual zero procedure and go to the CO Sensor Span procedure that follows.

1. If not already done, turn ON the analyzer and display the Main Menu screen.
2. Use the UP (▲) and DOWN (▼) arrow buttons to select the SETUP menu and press ENTER.
3. From the Setup Menu, use the UP (▲) and DOWN (▼) arrow buttons to select the CO Zero Setting parameter then press ENTER.

Figure 5-7: Main Menu & Setup Menu Screens

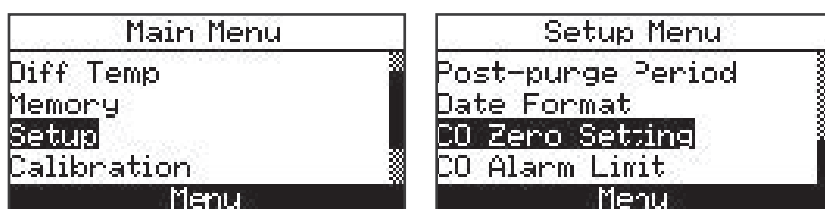

4. From the CO Zero Setting screen, use the DOWN (▼) arrow button to select the Manual Zero option then press ENTER. A reminder screen to place the instrument in fresh air is displayed.

Figure 5-8: CO Zero Setting & Manual Zero Screens



5. Press ENTER and wait for the manual zero to complete.

Figure 5-9: Complete Manual Zero Screen

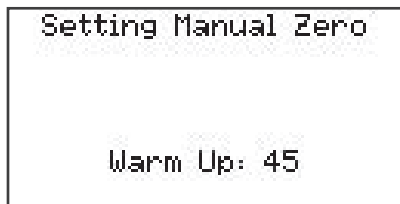

5.6.3 CO Sensor Span Procedure

1. From the Calibration Menu (see section 3.8), use the UP (▲) and DOWN (▼) arrow buttons to highlight CO, and then press ENTER to display the CALIBRATE CO screen. This requires password validation (see section 3.8).

Figure 5-10: Calibration Menu Screens

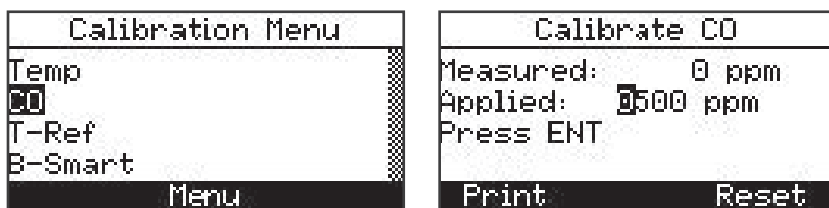

“Measured” is the current CO reading, while “Applied” is a known CO level that will be applied for calibration purposes.

2. Use the UP (▲) and DOWN (▼), LEFT (◀) and RIGHT (▶) arrow buttons to enter an Applied value that exactly equals the concentration stamped on the CO cylinder.



NOTE: Bacharach recommends using a 500 ppm calibration gas, however the calibration range is from 100 - 5,000 ppm. An attempt to calibrate outside this range will cause the message “Applied Value High” (or Low) to appear at the bottom of the screen.

3. Attach a 500 ppm CO cylinder to the regulator and connect calibration kit components as shown below. Apply 500 ppm carbon monoxide in an air balance calibration gas.
4. Wait until the Measured reading stabilizes and then press ENTER. The message “Good Calibration” should briefly appear.

If the sensor's output is low, but still usable, then the message "Good Calibration WARNING Low Sensor" will appear. The sensor will now be marked as being Low in the Warm-up screen.

If the sensor's output is too low to be usable, then the message "Bad Calibration Sensor End of Life, Entry Not Saved" will appear.

5. Close the regulator and remove the CO cylinder.

Figure 5-11: Kit and Setup

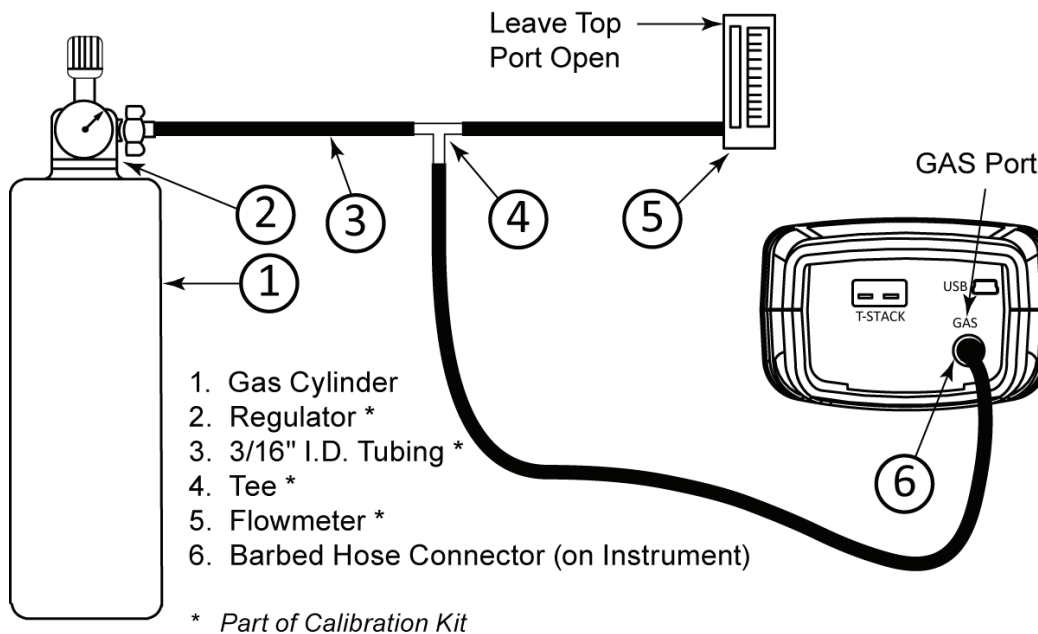

5.7 T-Ref Sensor Calibration

The T-Ref sensor is located inside the instrument. Calibration is done at the factory and should not need to be done in the field.

6. Troubleshooting

6.1	Error and Warning Messages	62
6.2	Replacement Parts.....	63
6.3	Accessories	63
6.4	Instrument Identification	64

6.1 Error and Warning Messages

Message	Description
Low Sensor CO	CO sensor output was low but still usable. Sensor may need to be replaced in the near future.
Low Battery	Battery voltage is low. Replace the batteries.
Applied Value High / Low	An attempt was made to calibrate a sensor outside its range—either above (<i>High</i>) or below (<i>Low</i>) the acceptable range.
Warm-up Sensor Error	<ul style="list-style-type: none"> CO sensor was not zeroed at warm-up because of high output. Run instrument on fresh air then restart instrument to re-zero sensor. If the message persists, the CO sensor may need to be replaced. Temperature sensors are measuring temperature outside the range of -4° to 212° F at warm-up. Make sure that the thermocouple is sampling ambient room air within the temperature range at warm-up. Messages will indicate which sensors are in error.
Set Clock	Time and date values need to be set in the instrument.
OVR	Occurs in the number fields of sensors that have achieved over-range condition.
***	Occurs in the number fields of sensors. Replaces in-error sensor values and any calculated values that depend on those sensor values.
---	Occurs in the number fields of sensors and indicates that values were not calculated.
Beeping	Slow beep frequency: Replace batteries warning. Fast beep frequency: CO alarm is active and set.



NOTE: If a particular sensor is in error during warm-up, the instrument automatically displays the error. The instrument continues to operate with the sensor in error, however information dependent on the sensor in error is not displayed.

6.2 Replacement Parts

Part Number	Description
0204-0004	Battery, AA Alkaline (<i>qty 1</i>)
0024-0997	CO sensor, uncalibrated
0024-1795	B-Smart® CO sensor
0019-7110	Replacement probe assembly with water trap
0019-3265	Replacement water trap for probe assembly 0024-7110
0007-1644	Replacement filter element for probe assembly 0024-7110
0024-1579	Replacement End Plate
0024-3073	Replacement Pump Assembly
0024-1620	Battery door/sensor cover
0019-9376	Instruction manual

6.3 Accessories

Part Number	Description
0024-1400	IrDA printer
0024-1310	Printer paper, box of 5 rolls
0021-7006	True Spot® Smoke Tester kit
0104-1798	Thermocouple (<i>temperature, air</i>), K-type (<i>1 inch long</i>)
0104-1797	Thermocouple (<i>temperature, stack</i>), K-type (<i>10 feet long</i>)
0024-7059	CO Calibration kit (<i>no gas</i>)
0024-0492	CO calibration gas, 500 ppm CO
0024-1470	PC Software Installer CD
0104-4032	USB cable (<i>A to Mini-B</i>)
0024-1461	Boot , rubber
0024-8265	Exhaust Probe Kit
0019-7111	Optional probe assembly with thermocouple

6.4 Instrument Identification

A label on the back of the instrument provides the following information that is useful for service and troubleshooting.

- manufacturer
- country of origin
- certification(s)
- part number
- serial number

Figure 6-1: Identification Label

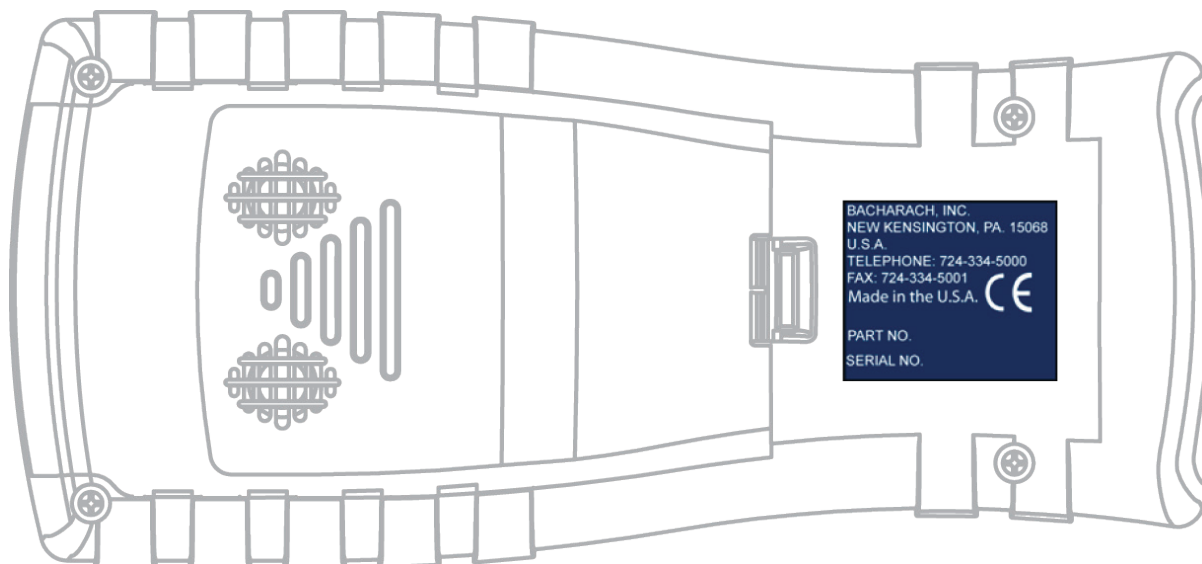

7. Additional Information

7.1	Bacharach Combustion App.....	65
7.2	Service Centers	65

7.1 Bacharach Combustion App

To download the Bacharach Combustion App, visit www.mybacharach.com/apps. The companion smartphone application allows users to perform the following functions:

- Transfer combustion data from analyzer via QR code
- Generate customizable reports (*reports may be shared via available email / cloud services*)

Category		Minimum Requirement
Operating System	Android 5.0 and later iOS 10 and later	
Hard Drive Space	Android:	50MB (<i>for the application only</i>)
	iOS:	30MB (<i>for the application only</i>)

7.2 Service Centers

Replacement parts and service can be obtained by contacting one of the following Bacharach Service Centers.

Location	Contact Information	Shipping Address
United States	Phone: +1 724 334 5000 Toll Free: +1 800 736 4666 Fax: +1 724 334 5001 Email: help@mybacharach.com	Bacharach, Inc. 621 Hunt Valley Circle New Kensington, PA 15068, USA
Europe	Phone: +353 1 284 6388 Fax: +353 1 284 6389 Email: help@mybacharach.com	Bacharach, Inc. Unit D12 & D13 Santry Business Park, Swords Road Santry, Dublin, Ireland
Canada	Phone: +1 905 882 8985 Fax: +1 905 882 8963 Email: support@bachcan.ca	Bacharach, Inc. 10 West Pearce Street, Unit 4 Richmond Hill, Ontario. L4B 1B6, Canada



THE MEASURABLE DIFFERENCE

Bacharach, Inc.
621 Hunt Valley Circle,
New Kensington, PA 15068 USA

Pittsburgh, PA USA | Dublin, IRE | Stanardsville, VA USA | Toronto, CAN
www.mybacharach.com | help@mybacharach.com

1.888.610.7664



www.calcert.com

sales@calcert.com